

ROBUST Series High-Speed Precision Bearings for Machine Tool Applications

NSK has introduced the ROBUST Series high-speed precision bearings, to transcend limitations in machine tool applications. These bearings maintain cool operating temperatures and are designed for heat-resistance. The ROBUST series is the latest development by NSK, which combines the best designs with superior technologies to offer effective product solutions for the machine tool industry.

New!



NSK's ROBUST series meets the demands of machine tools in the 21st century with high-reliability and maximum efficiency.

ROBUST Series High-Speed Precision Bearings

Through superior application knowledge and information technology, NSK offers clear and timely solutions that contribute to the design and development of new spindle applications.

Design

NSK's simulation technology and FEM analysis enable us to create the best design to achieve lower heat generation and high-reliability. NSK's extensive testing and research takes into account the types of machines, operating speeds and cost requirements for our customers. Cage designs are also improved through this process and verified by thorough testing.

Metallurgical Technology

NSK has developed "SHX" and "EP" bearing steels for longer life and wear-resistance. NSK has also developed heat-resistant PPS and PEEK cages suitable for high performance and wear-resistance.

Lubrication Technology

NSK has continued its commitment to lubrication technology by developing an oil-air lubrication unit, new lubrication methods, and new greases suited for the environment of the 21st century.

High Accuracy

NSK is the world leader in bearing supply to the machine tool industry. We have used our knowledge and experience in the field to design high-accuracy bearings, including the NSK/P2X (narrower tolerance of diameter than ISO class 2) series for lathes, machining centers and internal grinders.

Product Range

NSK provides a full range of bearing products for virtually any machine tool application.

- Ultra high-speed angular contact ball bearings
- High-speed, high-rigidity, thrust angular contact ball bearings
- Ultra high-speed cylindrical roller bearings
- High-rigidity double row cylindrical roller bearings

Global Network

NSK has 42 manufacturing facilities and an extensive global sales network to service customers around the world.



Features of "SHX" material

"SHX" has similar heat-resistant performance to "M50," which is used in bearings for jet engines and can operate at temperatures up to 300°C. However, SHX steel provides even better wear and seizure resistance and longer life than "M50."

"SHX" is the most suitable material for high-speed bearings with EHL lubrication, such as oil-air lubrication or grease lubrication. These conditions are typical of main shaft spindles in machine tools.

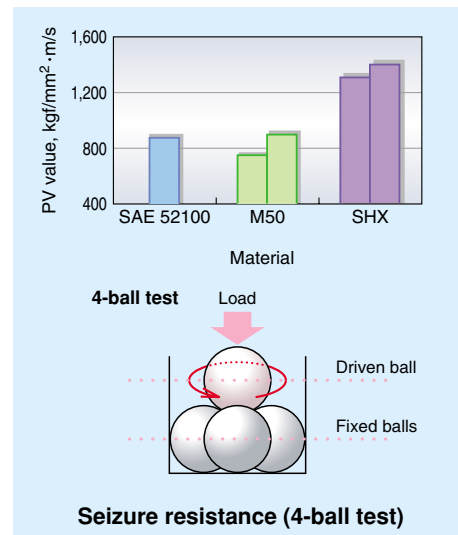
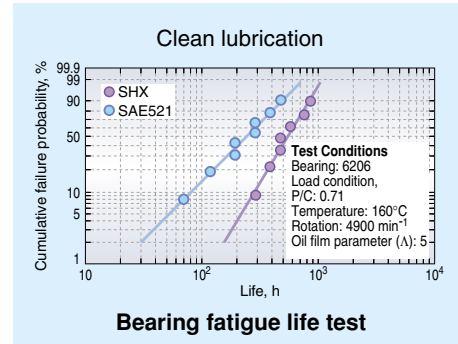

Features of "EP" material

NSK has developed new evaluation technology to measure oxide-inclusion, which shortens bearing fatigue life. NSK has used this technology, combined with improvements in bearing steel, to create the new "EP" material. EP material is an extremely clean bearing steel that is an improvement over VAR (Vacuum Arc Remelted: high-cleanliness steel) material.

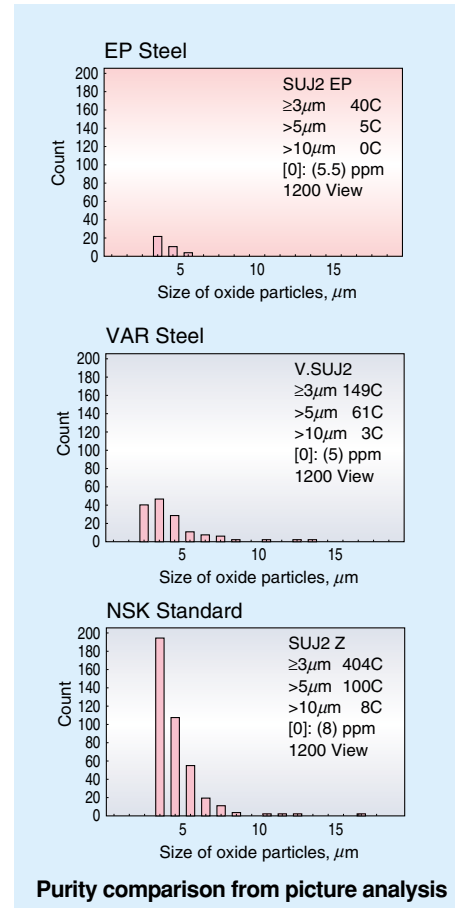

Features of ceramic ball angular contact ball bearings



- Limiting speed is 20% to 50% higher than steel ball bearings.
- 40% lower density than steel balls provides lower centrifugal force.
- Induced preload in operation by lower thermal expansion, and ball slipping are less than steel balls.
- Ceramic balls are 50% more rigid than steel balls, which provides high-rigidity for main shaft bearings.
- NSK ceramic balls with improved material provide high-accuracy.

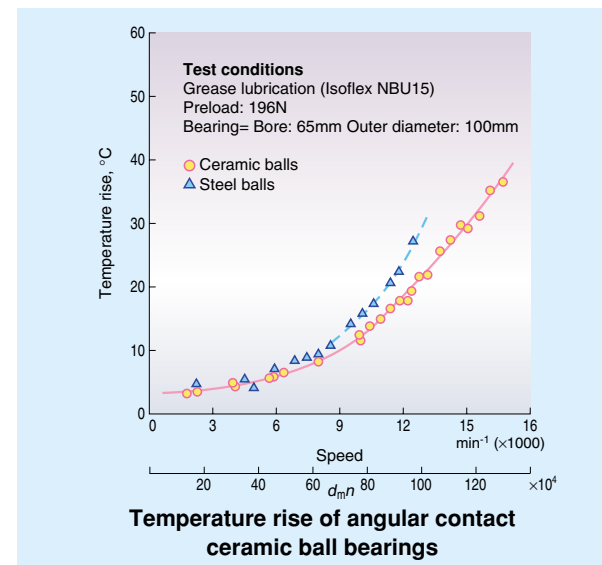

Feature comparison between ceramic and bearing steel

Each composition of ceramic and bearing steel

Characteristics	Bearing steel	Si ₃ N ₄
Density (g/cm ³)	7.8	3.2
Coefficient of linear expansion (1/°C)	(1/°C)12.5 × 10 ⁻⁶	3 × 10 ⁻⁶
Modulus of direct elasticity (MPa) {kgf/mm ² }	208000 {21200}	314000 {32000}
Poisson's ratio	0.3	0.25
Thermal conductivity (cal/cm·S·°C)	46	30

The composition of engineering plastic material for cages

	Tensile strength MPa	Tensile modulus GPa	Coefficient of linear expansion (×10 ⁻⁵ /°C)	Continuous running temperature (°C)
Polyamide 66	155	6	3.5	110
PEEK	240	11.6	4.5	240
L-PPS	131	8.8	2.8	220

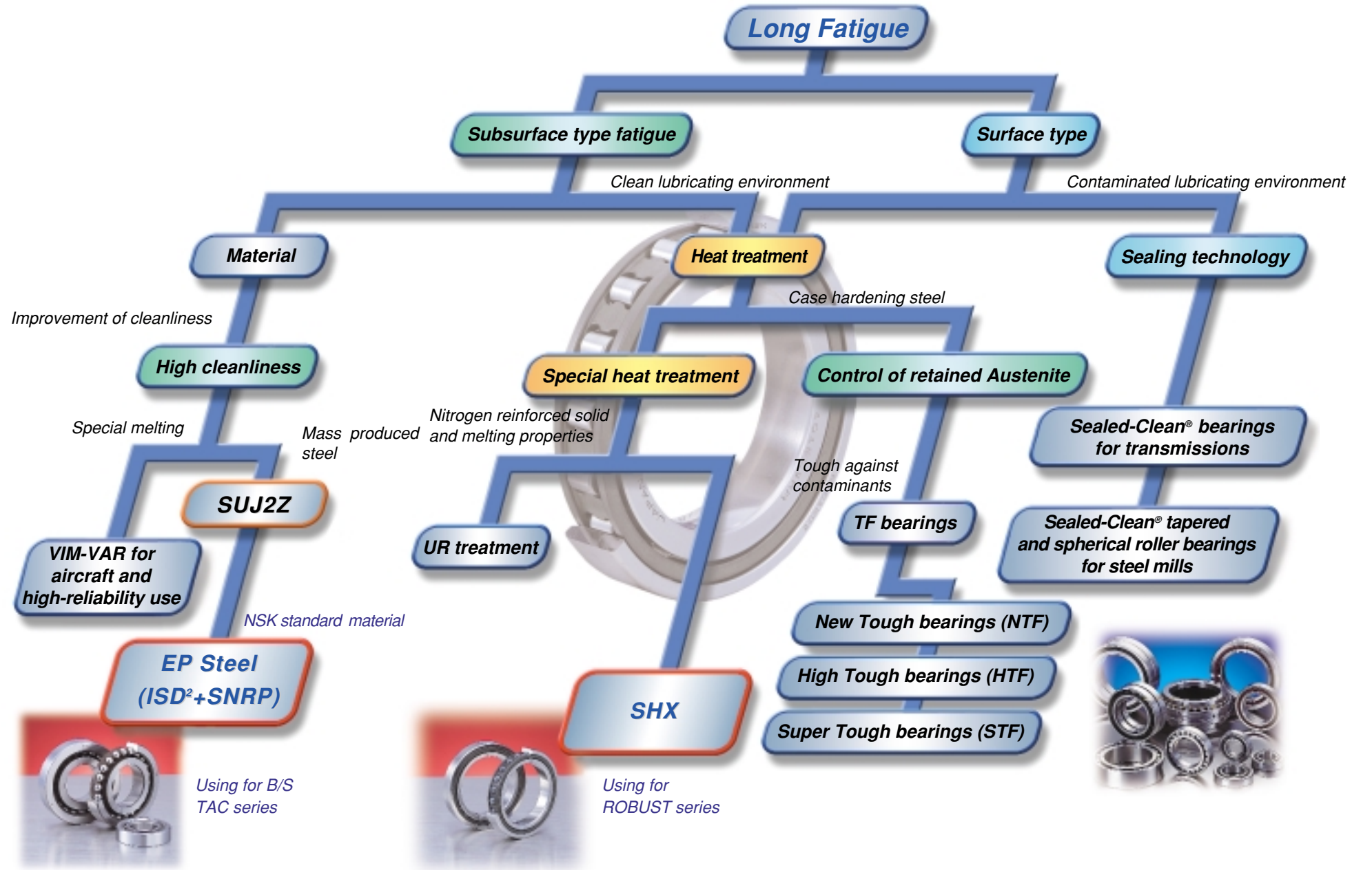

Precision Bearings for High-Speed Machining Centers

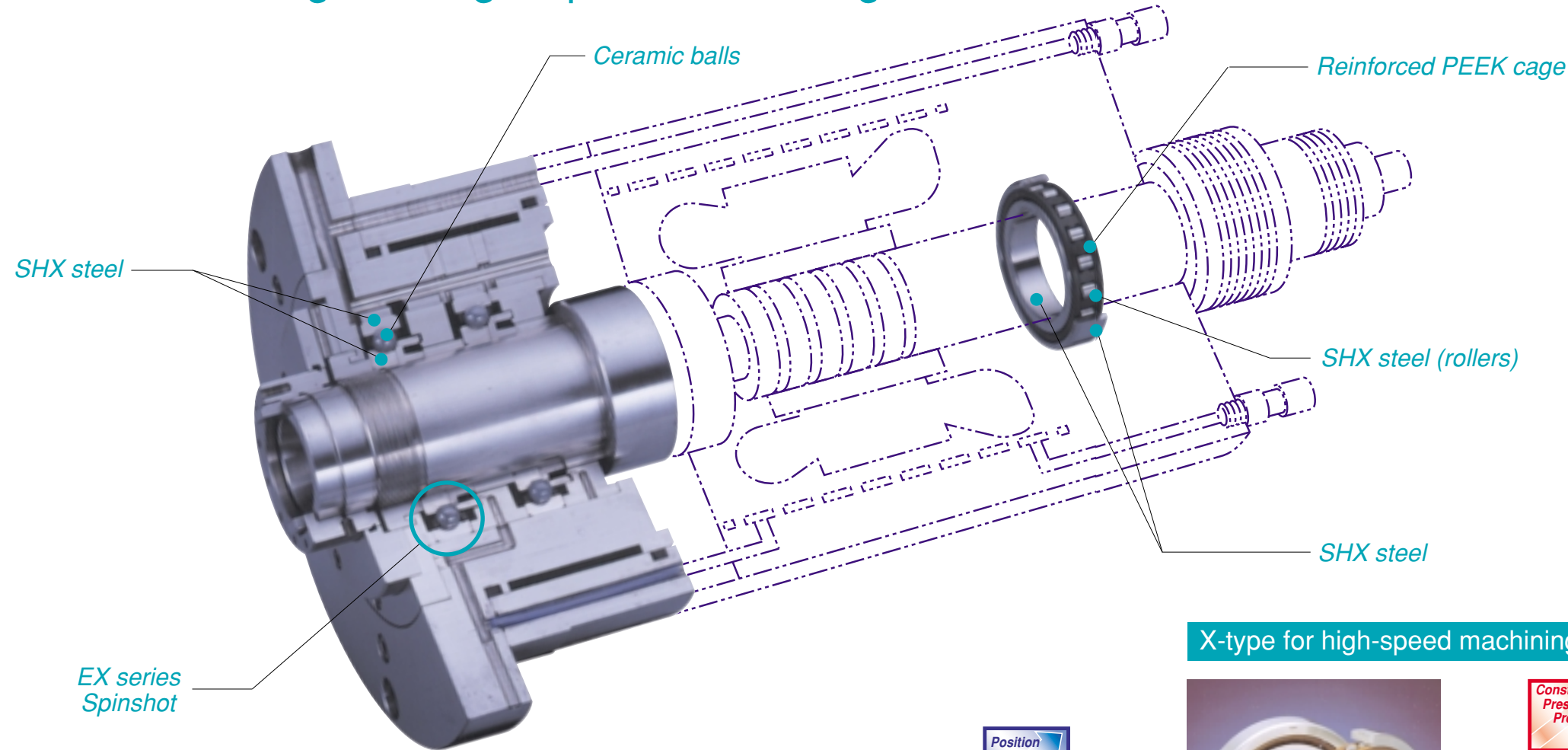

Bearing Nomenclature

Example: **65 BNR 10 S TYN DB L P4**

Nominal bearing bore	65
Indicates type of bearing	BNR: 18°
Size series no.	10: Bore, outer diameter and width are same as 70 series 19: Bore, outer diameter and width are same as 79 series
Balls and rings	S: balls and rings: bearing steel H: balls: silicon nitride, Si ₃ N ₄ /rings: bearing steel X: balls: silicon nitride, Si ₃ N ₄ /rings: SHX-steel
Cage symbol	T: Phenolic cage TYN: Polyamide cage (X type is T only)
Arrangement symbol	DB: Back-to-back arrangement DT: Tandem DBB: 4-row arrangement
Accuracy symbol	P4: ISO Class 4 P3: Dimensions-ISO Class 4 Running accuracy-ISO Class 2 P2: ISO Class 2
Preload symbol	EL: Extra light L: Light CP: Preload (negative clearance) (CP10: -10 μm) CA: Axial clearance (CA10: +10 μm)

EX series features for ultra high-speed machining centers

A spindle supported by an angular contact ball bearings and cylindrical roller bearings can achieve speeds of over 2.0M $d_m n$, due largely to the specific improvements from NSK.

- 1. ROBUST design utilized computer analysis**
The ROBUST concept was developed by analyzing roller skew, ball spin and temperature rise in bearings, then selecting optimum design changes to improve bearing performance in these areas.
- 2. SHX steel for heat and wear resistance**
ROBUST cylindrical roller bearings use SHX material, designed for heat and wear resistance. Under EHL conditions in high-speed applications, these bearings provide longer life and increased seizure resistance.
- 3. Rolling element material availability**
ROBUST angular contact ball bearings feature ceramic balls. ROBUST cylindrical roller bearings are supplied with "SHX" rings and rollers. When compared to cylindrical ceramic roller bearings, the ROBUST design provide superior anti-seizure performance, economic solution, and solve the insulation problem.
- 4. Super high-accuracy class P2X (special tolerance which has higher dimensional tolerance than ISO class 2)**
NSK can provide higher accuracy in special applications with the P2X class of bearings.
- 5. New cage for high-speed**
NSK provides a bearing cage suitable for high speeds. The PEEK cage is lightweight and designed for heat resistance, high-rigidity and wear resistance.



Ultra high-speed Spinshot bearing

These bearings use Spinshot lubrication for EHL, and ultra high-speed.

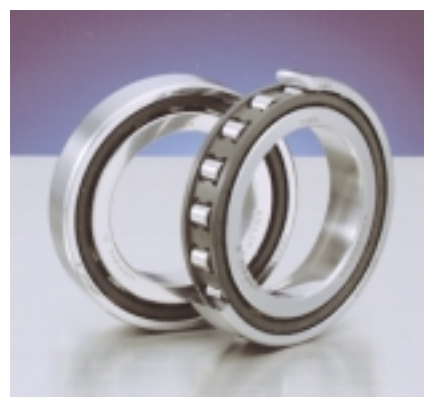

Ultra high-speed cylindrical roller bearing

These bearings simplify the structure of the integrated spindle at the rear side, and are available for speed greater than 1.2M $d_m n$.

X-type for high-speed machining centers

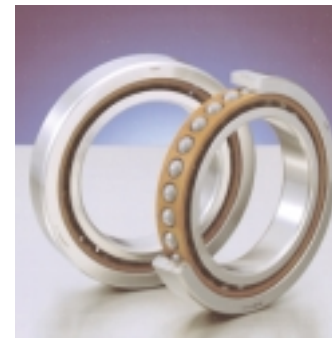

Constant Pressure Preload
Up to 2.5M $d_m n$

Position Preload
Up to 2.0M $d_m n$

These bearings are designed with "SHX" rings and ceramic balls.

H-type for high-speed machining centers



Constant Pressure Preload
Up to 1.4M $d_m n$

Position Preload
Up to 1.4M $d_m n$

These bearings are designed with bearing steel rings, ceramic balls, and a polyamide cage. Meets speeds up to 1.4M $d_m n$ with grease lubrication.

S-type for high-speed machining centers

These bearings are made with bearing steel rings and balls, and a polyamide cage. These bearings can replace the current NSK "BNC" series.

Position Preload
Up to 0.9M $d_m n$

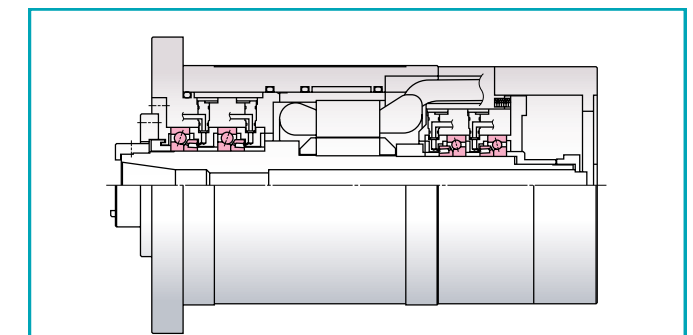

Structure of the test spindle

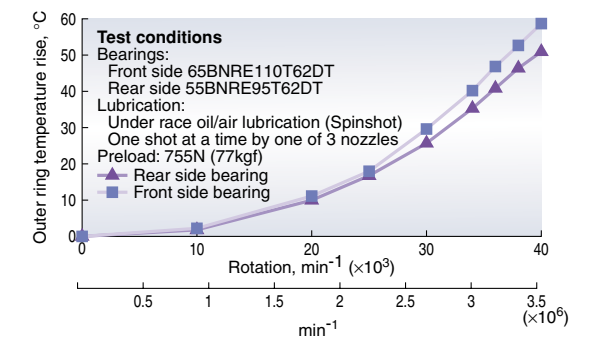

Temperature rise under oil-air lubrication and spring preload

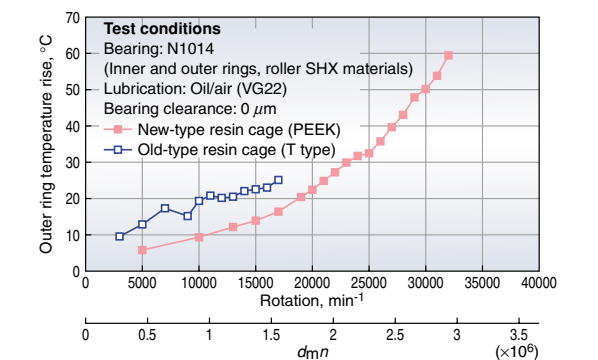

Temperature rise of cylindrical roller bearing with plastic cage

Precision Bearing Recommendation for Lathe Applications

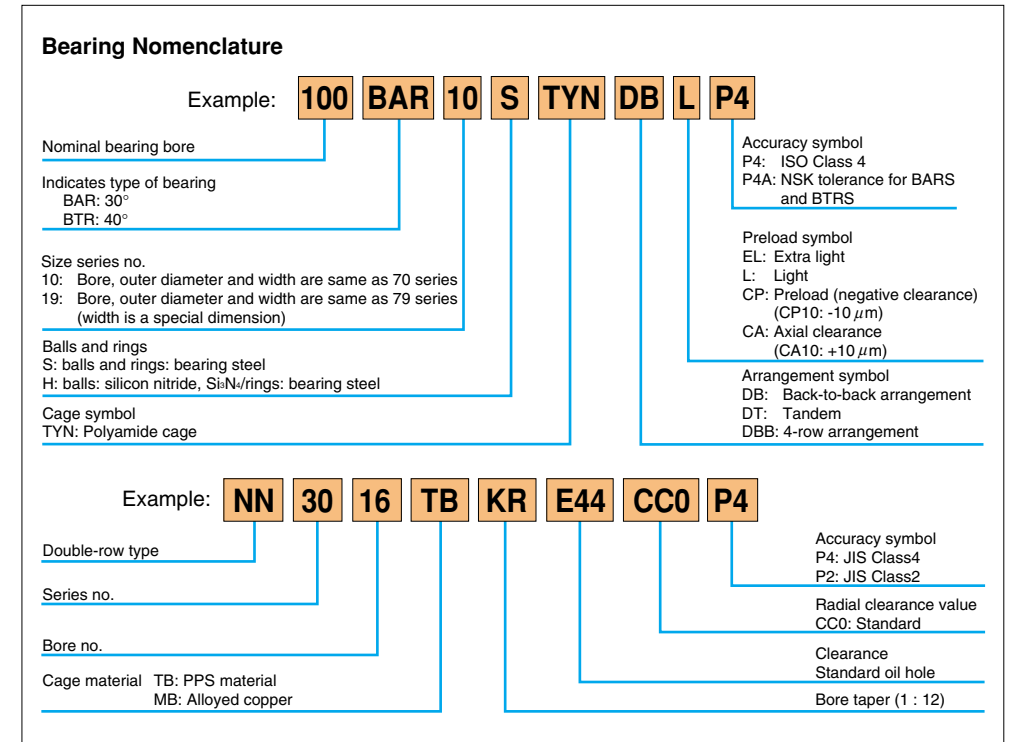
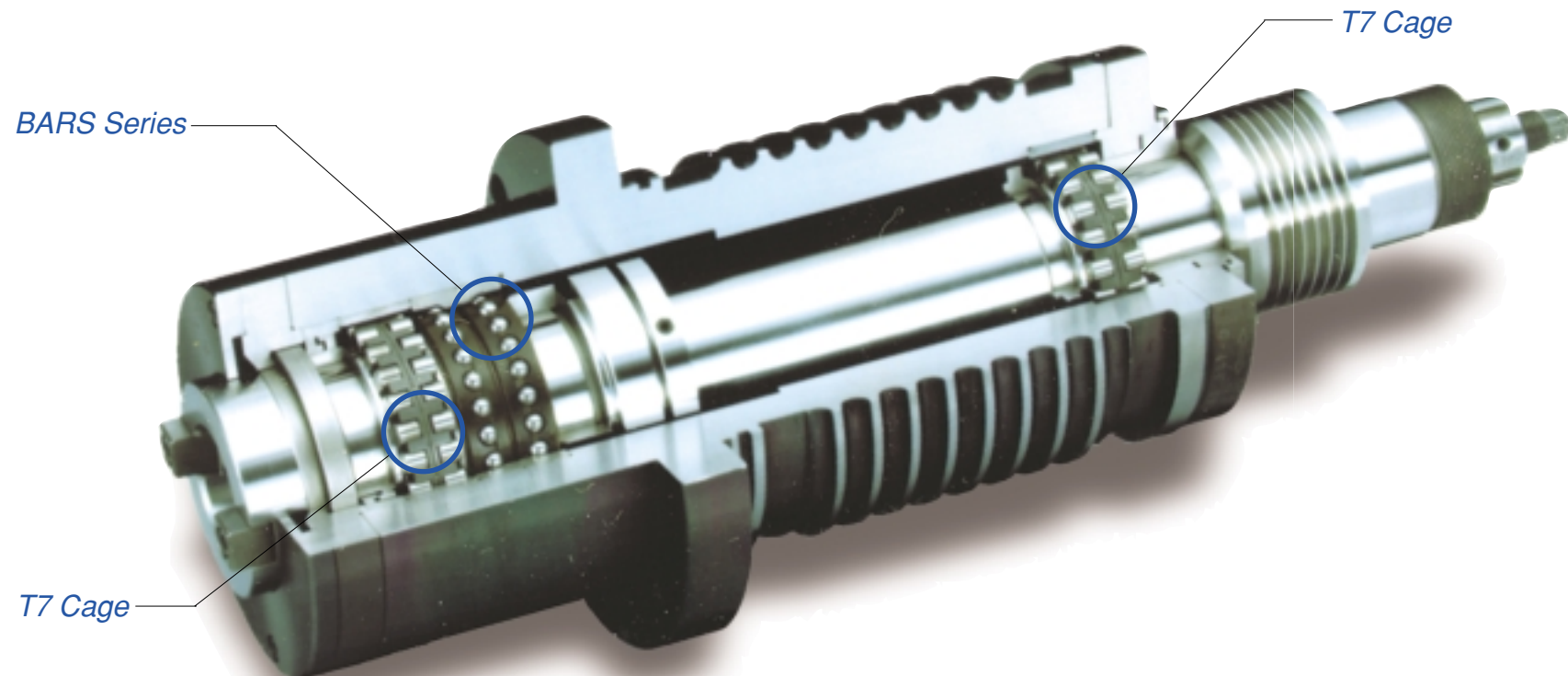

Features of high-speed, high-rigidity bearings for lathe applications

This NSK bearing is designed to achieve lower heat generation higher speeds in lathes through improved grease lubrication. Oil-air lubrication results in a limiting speed of 1.0M dmn for these bearings.

1. High-accuracy, P2X class

NSK standardized P2X class, suited for lathes.

2. Lightweight cage extends grease life

The newly developed "T7" plastic cage, also solves noise problems.



High-rigidity double row cylindrical roller bearings

Position Preload $d_m n$ Up to 1.0M $d_m n$

Roller guided T7 cage (L-PPS material used).



BARS type, 30 degree contact angle, for high-speed lathes

Position Preload $d_m n$ Up to 0.7M $d_m n$

Angular contact thrust ball bearing with improved design for lower internal heat generation.

BTRS type, 40 degree contact angle, low heat generation, high-rigidity



Position Preload $d_m n$ Up to 0.6M $d_m n$

Angular contact thrust ball bearing with improved design for lower internal heat generation and high-rigidity.

TAC type, 60 degree contact angle, ultra high-rigidity

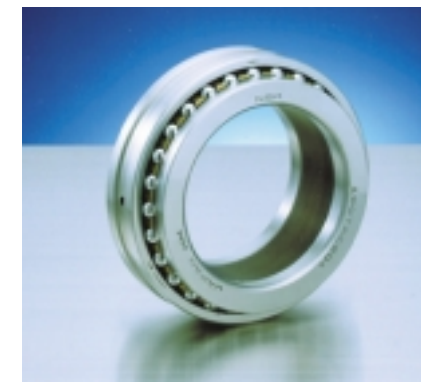

Position Preload $d_m n$ Up to 0.45M $d_m n$

Angular contact thrust ball bearing with ultra high-rigidity.

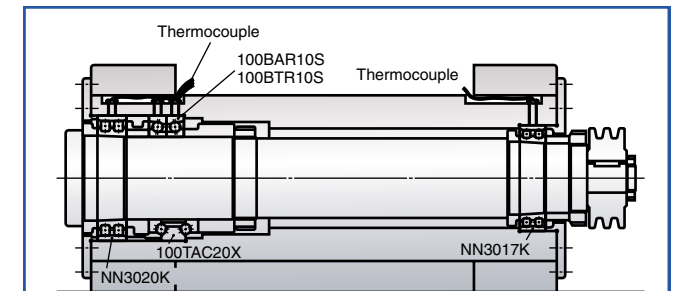

Testing machine structure

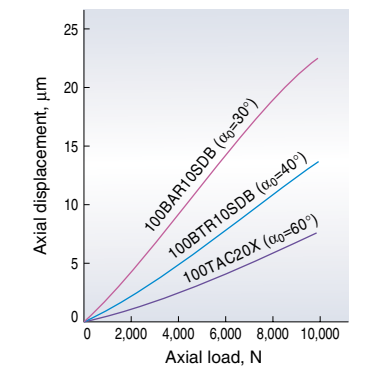

Axial load and displacement

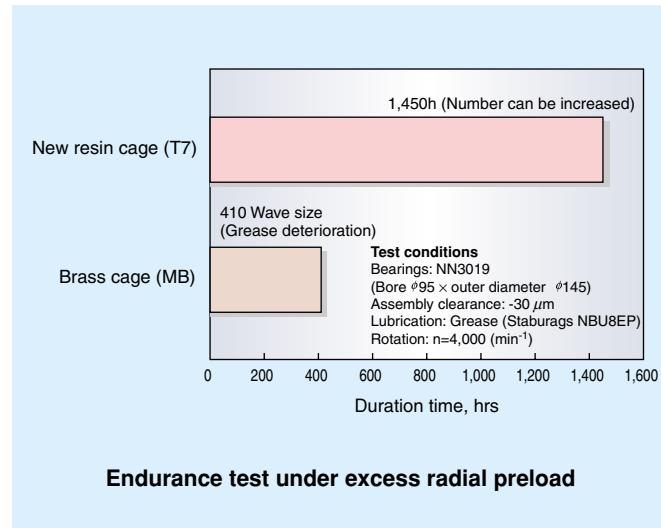
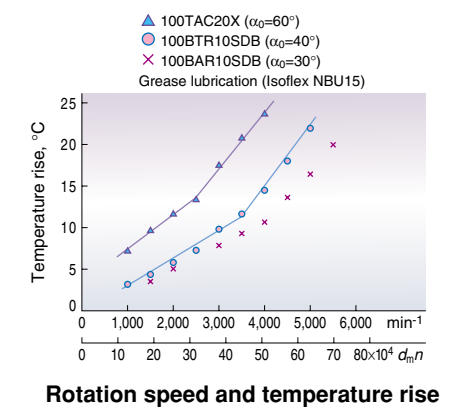

NSK Recommendation

Precision Bearings for Ultra High-Speed Internal Grinder Applications

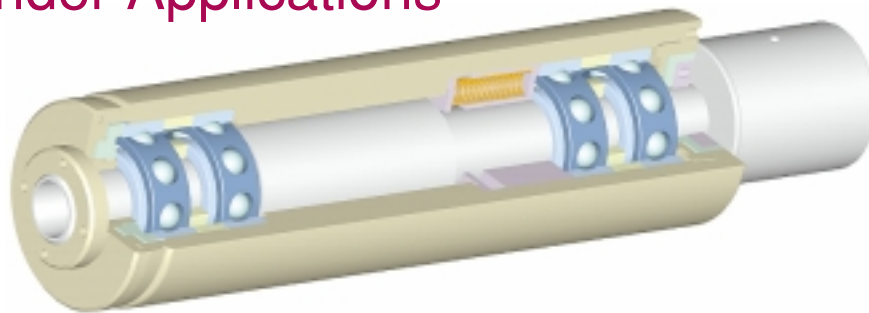

Features of the BGR angular contact ball bearing series

The rotational speed of internal grinders is usually extremely high, therefore, most high-speed grinder applications have spring preload and are lubricated by oil-air or oil-mist. NSK's BGR series is best for these applications.

1. Designed with oil-air or oil-mist lubrication

Their counterbored inner rings make them suitable for spray oil.

2. Outer ring guided phenolic cage

3. Designed for easy assembly

One pair of bearings can be used in any combination of DB, DF, DT.

The standard contact angle is 15 degrees.

4. High accuracy, suitable for high-speeds

Standard accuracy class is JIS class 2 (ABMA ABEC9).

BGR angular contact ball bearing

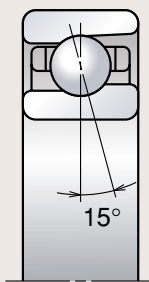

Ball Screw Support Bearings

Features of precision thrust angular contact ball bearing for ball screw support applications

1. Longer life

These bearings are made with "EP" material.

2. High-rigidity

An increased number of balls combined with a 60 degree contact angle allows for higher axial rigidity.

3. Lower torque

The torque of these bearings is lower than that of tapered or cylindrical roller bearings. Lower torque results in more accurate rotation.

4. Easy handling

Preload is the same for bearings with a universal combination of the same part number. It is also easy to handle these bearings because the inner and outer rings are non-separable.

5. High-accuracy

The optimized design of this plastic cage enables high accuracy.



ROBUST Series High-Speed Precision Bearings

Oil-air Lubrication Units

Features of the “Fine Lube”

1. High-speed capacity and low dynamic torque

Oil-air lubrication allows high-speed operations without excessive torque and temperature rise. Lubricators supply only a small amount of oil to each bearing—only the amount needed for safe lubrication. Quantity-constant pistons meter the oil gradually at precise intervals with high-reliability.

2. Oil is continuously supplied to bearings with compressed air

Although the oil is fed in intervals, it arrives at the bearing in a near constant stream due to the delivery mechanism of clean, dry, continuous compressed air.

3. Reduced temperature rise with air-cooling

With the amount of oil regulated, there is very little agitation resistance and temperature rise in the bearing. The constant flow of compressed air through the spindle also helps to reduce heat.

High-reliability. The high air pressure inside the spindle, from the oil transfer, stops coolant, cutting chips and other materials from entering the bearing. Unlike grease and other forms of oil lubrication, there is no deterioration of the lubricant, because only clean, fresh oil is used. These advantages make the NSK Fine Lube ideal for modern machine tools where coolant is used heavily.

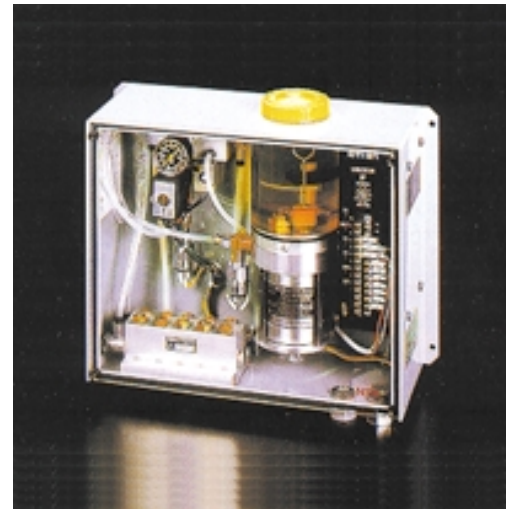

Additional Related Catalogues



CAT.No.E124:
Precision Rolling Bearings for
Machine Tools

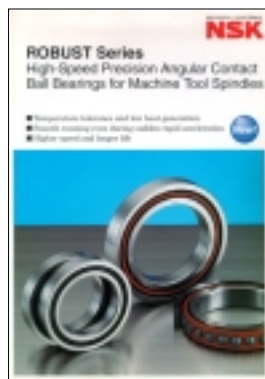

CAT.No.E1221:
Robust Series, High-Speed Precision
Angular Contact Ball Bearings for
Machine Tool Spindles



CAT.No.E1212:
Ball Screw Support Bearings
Made of EP Steel



CAT.No.E1392:
Precision Ceramic Angular
Contact Ball Bearings for High-
Speed Machine Tool Spindles



CAT.No.E1204:
For High-Speed Machine Tool
Spindles Neo-Bird Angular Contact
Ball Bearings