

NSK Linear Guides

Miniature PU Series/PE Series

Series of interchangeable products that enable random matching between rails and ball slides. Miniature PU and PE series support diverse applications, from semiconductor manufacturing devices to medical equipment.

Patent Pending

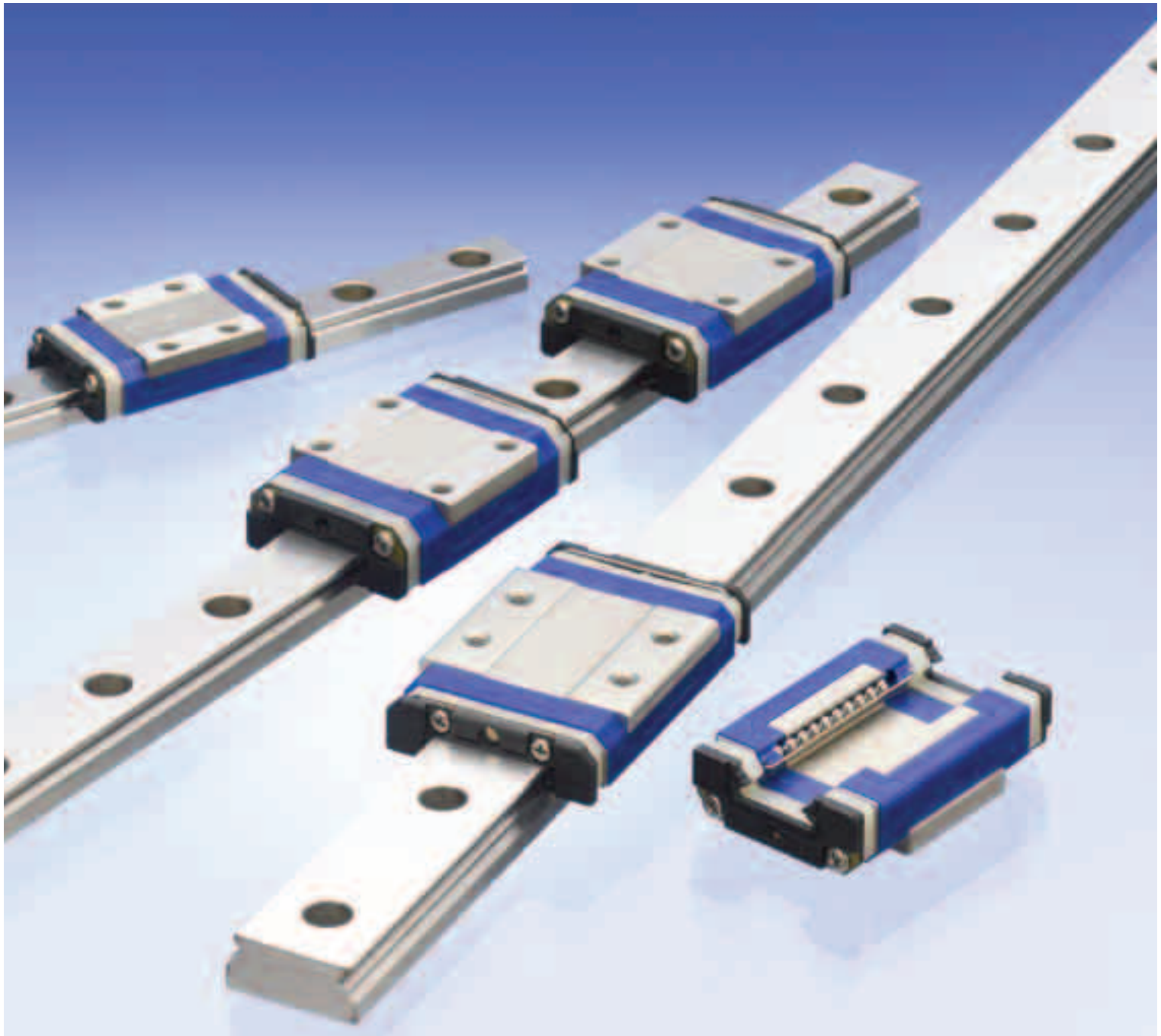

Easy-to-handle, lightweight design.
NSK Miniature Linear Guide provides smoother motion with unprecedented lightness.

The new generation PU series/PE series inherit the outstanding lineage of the NSK miniature linear guides LU series/LE series. Resin ball recirculation components improve dynamic friction characteristics and create smoother motion with reduced noise intensity. High performance features enhanced dust-proofing, low dust generation, and high corrosion resistance. The new design supports a wide variety of applications.

Ergonomic, gentler tone and low dust generation. NSK Linear Guides Miniature PU Series (Interchangeable with the LU Series)

Ideal for wide, single-rail applications. NSK Linear Guides Miniature PE Series (Interchangeable with the LE Series)

1 Features

1. Motion performance

Newly designed recirculation component facilitates smooth circulation of steel balls.

2. Lightweight

The ball slide is fabricated to be approximately 20% lighter than conventional models* by the application of resin to a part of its body.

*: Miniature LU series/LE series

3. Reduced noise intensity

Resin components applied in ball circulating circuits reduce collision noise between steel balls.

4. Low dust generation

The structure of the ball slide is designed to prevent dust generation.

5. Excellent dust-proofing

The labyrinth structure adopted for the side of the rails and the inner walls of the ball slide allows effects equivalent to an under seal.

6. High corrosion resistance

High corrosion-resistant martensite stainless steel incorporated as a standard feature provides excellent resistance to corrosion

7. Easy to handle

Safety design includes a retainer that prevents steel balls from dropping out of the ball slide even when the slide is removed from the rail.

8. Long-term maintenance-free

Equipped with NSK K1™ Lubrication unit realizes long-term, maintenance-free use.

9. Fast delivery

Lineup of interchangeable rails and ball slides in the series supports random matching and facilitates fast delivery.

New Smoother motion with resin recirculation circuits.
 Gentler tone and low dust generation.

NSK Linear Guides Miniature **PU Series**
PE Series

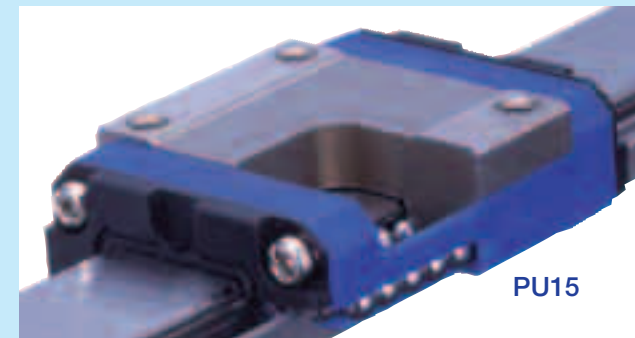
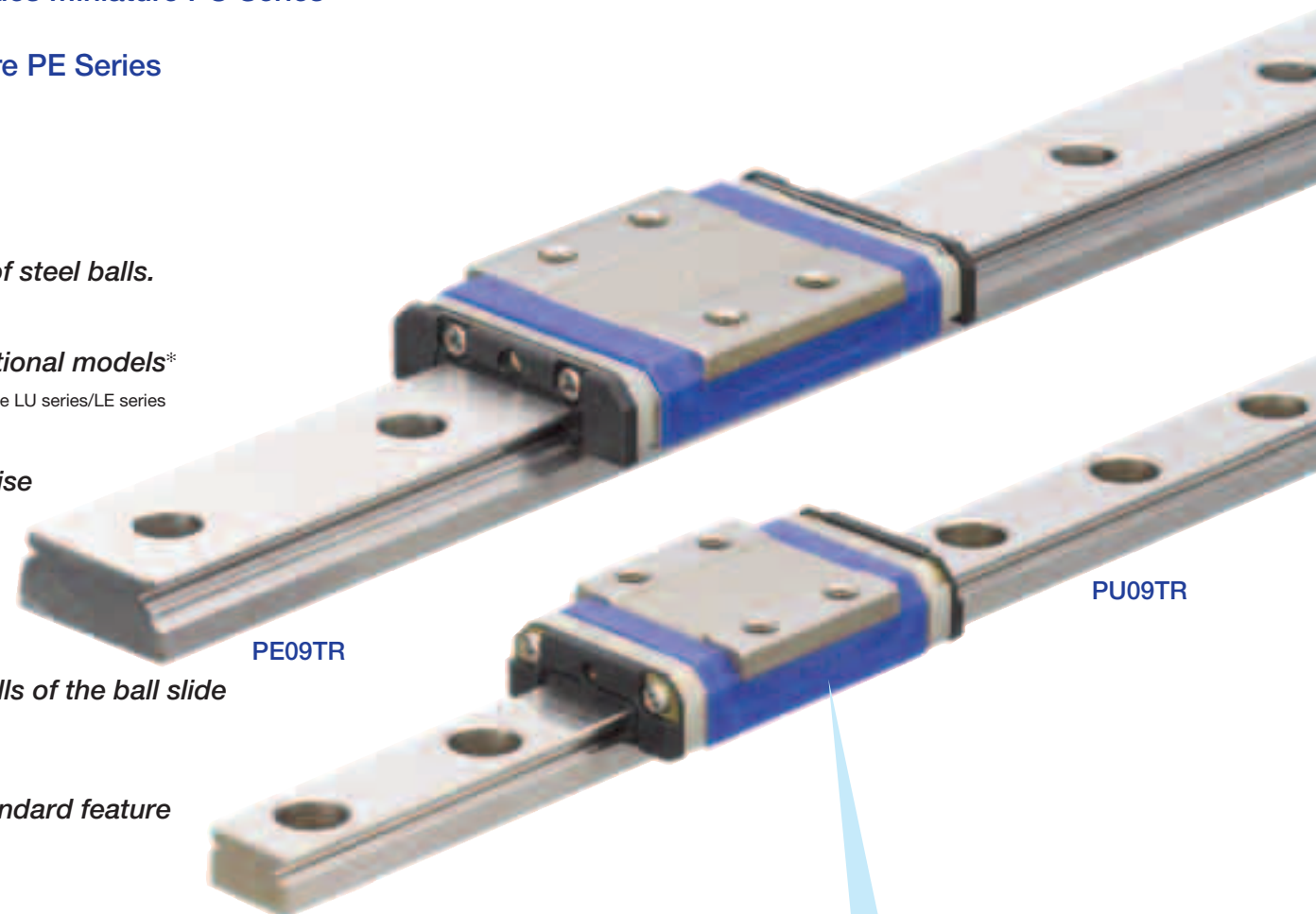

Cut model

Smoother motion

The resin ball recirculation component creates an optimal configuration allowing gentler contact with steel balls, resulting in improved dynamic friction characteristics and smoother motion.

Test conditions: Oil lubrication (VG68)
 Operating speed: 1,000 mm/min
 Load cell rated capacity: 5N

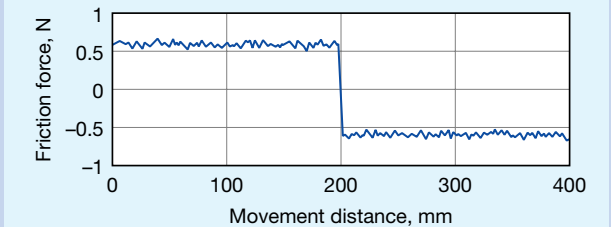

Fig. 1-1 Fluctuations in dynamic friction

Low dust generation

The PU series/PE series, with resin ball recirculation components, generates less dust than a conventional ball recirculation hole that goes right through the ball slide.

Test conditions: Grease lubrication (LG2)
 Operating speed: 600 mm/min
 Stroke: 200 mm

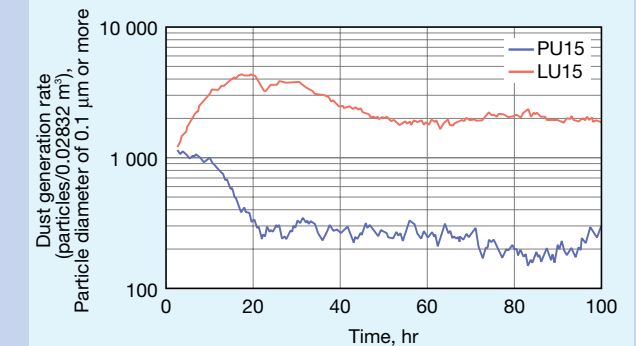

Fig. 1-2 Dust generation rate

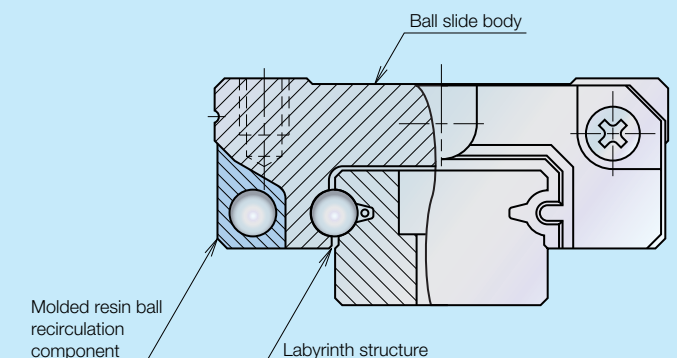

Fig. 2 Cross sectional front view

For cutting-edge precision positioning table, from semiconductor manufacturing devices to medical equipment.

—NSK Linear Guides Miniature PU Series/PE Series

2 Reference number

Reference numbers will be used as reference before finalizing all specifications. These numbers indicate outline specifications. Please specify the reference number, except design serial number, to identify the product when ordering, requesting estimates, or inquiring about specifications from NSK. The reference number is a set number for a single rail. For multiple rails, at least two sets of reference numbers are required.

2.1 Preloaded assembly type

Example: PU 15 0470 AL K 2 - P5 1 - II**

Series name: PU, Size: 15, Rail length (mm): 0470, Ball slide shape code: AL, Material/surface treatment: K, H, No end code: Single rail, -II: Two rails (*), Preload code: 0: Fine clearance (Z0), 1: Slight preload (Z1), Accuracy grade: P5, Design serial number: 1, Number of ball slides per rail: II

Accuracy grade PN: Normal, P6: Precision, P5: High precision, P4: Super precision (with NSK K1) KN: Normal, K6: Precision, K5: High precision, K4: Super precision

(*) Please note that the appropriate design number will be inserted into the reference number and the tag end code (-II) will be omitted.

2.2 Interchangeable type

(1) Reference number for rail and ball slide assembly

Example: PU 15 0470 AL K 2 - PC T - II**

Series name: PU, Size: 15, Rail length (mm): 0470, Ball slide shape code: AL, Material/surface treatment: K, H, No end code: Single rail, -II: Two rails (*), Preload code: T: Fine clearance compatible (ZT), Accuracy grade: PC: Normal (with NSK K1) KC: Normal, Design serial number: T, Number of ball slides per rail: II

(*) Please note that the appropriate design number will be inserted into the reference number and the tag end code (-II) will be omitted.

(2) Reference number for ball slide of interchangeable type

Example: PA U 15 AL S - K

Single ball slide code: PA, Series name U: PU, E: PE, Size: 15, Material code S: Stainless steel, Ball slide shape code: AL, Option code -K: products with NSK K1

NSK Linear Guides Miniature PU Series/PE Series

(3) Reference number for rail of interchangeable type

Example: P1 U 15 0470 R K N - PC T**

Single rail code: P1, Series name U: PU, E: PE, Size: 15, Rail length (mm): 0470, Rail shape code: R, S: PU09-12, R: PU05-15 PE05-07-09-12, P: PE15, Material/surface treatment: K: Stainless steel, H: Stainless steel + surface treatment, Joint rail code (*): N: non-jointed rails, L: joint rails, Accuracy grade: PC: Normal (with NSK K1) KC: Normal, Preload code T: Fine clearance compatible (ZT), Design serial number: T

(*) Please contact with NSK for more details regarding joint rails.

3 Accuracy standard

We offer the following product accuracy grades: Super precision grade P4, High precision grade P5, Precision grade P6, and Normal grade PN for preloaded assembly type, and Normal grade PC for interchangeable type.

Table 1 Accuracy standard for preloaded assembly types Unit: μm

| Item | Accuracy grade | | | |
|---|----------------------------------|-------------------|--------------|-----------|
| | Super precision P4 | High precision P5 | Precision P6 | Normal PN |
| Mounting height H | ± 10 | ± 15 | ± 20 | ± 40 |
| Variation of Mounting height H (All ball slides on a pair of rails) | 5 | 7 | 15 | 25 |
| Mounting width dimension W_2 or W_3 | ± 15 | ± 20 | ± 30 | ± 50 |
| Variation of Mounting width dimension W_2 or W_3 (All ball slides on datum rails) | 7 | 10 | 20 | 30 |
| Running parallelism of face C against face A | Refer to Table 3, Fig. 3, Fig. 4 | | | |
| Running parallelism of face D against face B | | | | |

Table 3 Running parallelism tolerance Unit: μm

| Rail length (mm) | Accuracy grade | | Preloaded assembly type | | | | Interchangeable type |
|------------------|----------------|---------|-------------------------|-----|-----|-----|----------------------|
| | over | or less | P4 | P5 | P6 | PN | PC |
| 50 | 2 | 2 | 4.5 | 6 | 6 | 6 | |
| 50 ~ 80 | 2 | 3 | 5 | 6 | 6 | 6 | |
| 80 ~ 125 | 2 | 3.5 | 5.5 | 6.5 | 6.5 | 6.5 | |
| 125 ~ 200 | 2 | 4 | 6 | 7 | 7 | 7 | |
| 200 ~ 250 | 2.5 | 5 | 7 | 8 | 8 | 8 | |
| 250 ~ 315 | 2.5 | 5 | 8 | 9 | 9 | 9 | |
| 315 ~ 400 | 3 | 6 | 9 | 11 | 11 | 11 | |
| 400 ~ 500 | 3 | 6 | 10 | 12 | 12 | 12 | |
| 500 ~ 630 | 3.5 | 7 | 12 | 14 | 14 | 14 | |
| 630 ~ 800 | 4.5 | 8 | 14 | 16 | 16 | 16 | |
| 800 ~ 1000 | 5 | 9 | 16 | 18 | 18 | 18 | |
| 1000 ~ 1250 | 6 | 10 | 17 | 20 | 20 | 20 | |

Table 2 Accuracy standard for interchangeable type Unit: μm

| Item | Accuracy grade |
|---|----------------------------------|
| | Normal PC |
| Mounting height H | ± 20 |
| Variation of Mounting height H (one rail) | 15 |
| Variation of Mounting height H (multiple rails) | 30 |
| Mounting width dimension W_2 or W_3 | ± 20 |
| Variation of Mounting width dimension W_2 or W_3 (All ball slides on datum rails) | 20 |
| Running parallelism of face C against face A | Refer to Table 3, Fig. 3, Fig. 4 |
| Running parallelism of face D against face B | |

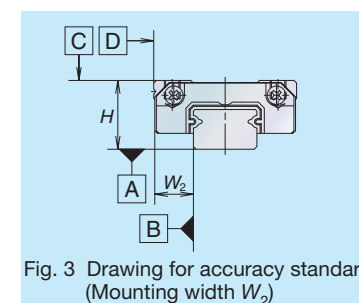

Fig. 3 Drawing for accuracy standard (Mounting width W_2)

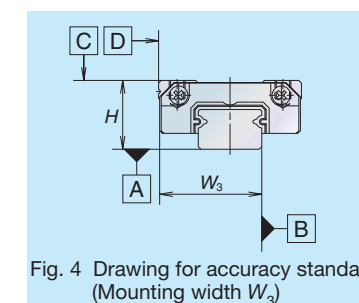

Fig. 4 Drawing for accuracy standard (Mounting width W_3)

4 Preload and rigidity

We offer three levels of preload: Slight preload (Z1) and Fine clearance (Z0), along with interchangeable types of Fine clearance (ZT). Values for preload and rigidity of the preloaded assembly types are shown in Tables 4 and 5.

Table 4 Preload and rigidity of preloaded assembly of PU series

| Model No. | Preload (N) | | Rigidity (N/μm) |
|-----------|---------------------|--|---------------------|
| | Slight preload (Z1) | | Slight preload (Z1) |
| PU05TR | 0 ~ 3 | | 17 |
| PU07AR | 0 ~ 8 | | 22 |
| PU09TR | 0 ~ 10 | | 30 |
| PU12TR | 0 ~ 17 | | 33 |
| PU15AL | 0 ~ 33 | | 45 |

Table 5 Preload and rigidity of preloaded assembly of PE series

| Model No. | Preload (N) | | Rigidity (N/μm) |
|-----------|---------------------|--|---------------------|
| | Slight preload (Z1) | | Slight preload (Z1) |
| PE05AR | 0 ~ 28 | | 45 |
| PE07TR | 0 ~ 29 | | 46 |
| PE09TR | 0 ~ 37 | | 61 |
| PE12AR | 0 ~ 40 | | 63 |
| PE15AR | 0 ~ 49 | | 66 |

Clearance of fine clearance Z0 is 0-3 μm. Therefore, preload is zero.

Clearance values of the interchangeable types are shown in Tables 6 and 7.

Table 6 Clearance of interchangeable type of PU series

| Model No. | Fine clearance | |
|-----------|----------------|--|
| | ZT | |
| PU05TR | Less than 3 | |
| PU07AR | | |
| PU09TR | | |
| PU12TR | | |
| PU15AL | | |

Table 7 Clearance of interchangeable type of PE series

| Model No. | Fine clearance | |
|-----------|----------------|--|
| | ZT | |
| PE05AR | Less than 3 | |
| PE07TR | | |
| PE09TR | | |
| PE12AR | | |
| PE15AR | | |

5 Applications

- **Smoother motion and low dust generation**
Liquid crystal manufacturing and printed circuit board manufacturing devices
- **Lightweight and low dust generation**
Semiconductor manufacturing devices (mounter, die bonder, and exposure device)
- **Gentler tone and excellent dust proof features**
Medical machinery and various precision devices

6 Height and corner configuration of the mount face

Figs. 5, 6 and Tables 8, 9 show the shoulder height and corner radius dimensions, when fixing the linear guide horizontally by pushing it onto the shoulder (projected portion from the mount face) of the bed or table.

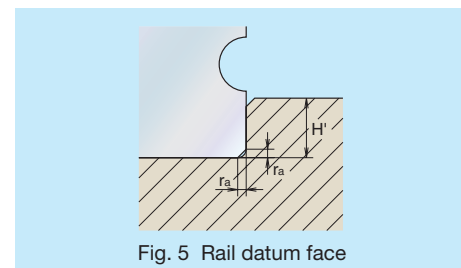

Fig. 5 Rail datum face

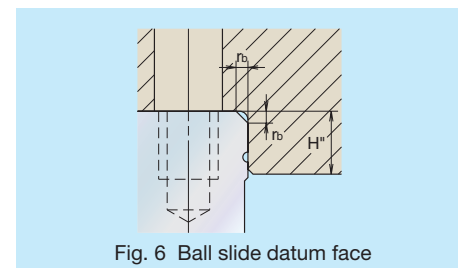

Fig. 6 Ball slide datum face

Table 8 Shoulder height and corner radius of the mount face (PU series) Unit: mm

| Model No. | Corner radius (Maximum) | | Shoulder height | |
|-----------|-------------------------|----------------|-----------------|--------|
| | r _a | r _b | H' | H''(*) |
| PU05TR | 0.2 | 0.2 | 0.7 | 2.3 |
| PU07AR | 0.2 | 0.3 | 1.2 | 2.5 |
| PU09TR | 0.3 | 0.3 | 1.9 | 2.6 |
| PU12TR | 0.3 | 0.3 | 2.5 | 3.4 |
| PU15AL | 0.3 | 0.5 | 3.5 | 4.4 |

(*)H'' is the minimum recommended value based on the dimension T in Table 13.

Table 9 Shoulder height and corner radius of the mount face (PE series) Unit: mm

| Model No. | Corner radius (Maximum) | | Shoulder height | |
|-----------|-------------------------|----------------|-----------------|--------|
| | r _a | r _b | H' | H''(*) |
| PE05AR | 0.2 | 0.2 | 1.1 | 2.5 |
| PE07TR | 0.2 | 0.3 | 1.7 | 3 |
| PE09TR | 0.3 | 0.3 | 3.5 | 2.8 |
| PE12AR | 0.3 | 0.3 | 3.5 | 3.2 |
| PE15AR | 0.3 | 0.5 | 3.5 | 4.1 |

(*)H'' is the minimum recommended value based on the dimension T in Table 14.

7 Lubrication

Selection of grease: Table 10 below shows grease that is suitable for the PU series/PE series. We specify PS2 as the standard grease for NSK miniature linear guides.

Table 10 Grease list

| Grease code | Thickener | Base oil | Base oil kinematic viscosity mm ² /s (40°C) | Temperature range for use (°C) | Characteristic Application |
|-------------|--------------|---|--|--------------------------------|--|
| PS2 | Lithium type | Synthetic oil + Mineral oil | 15 | -50 to 110 | • Better low temperature and dynamic characteristics • Suitable for high speed and light load application |
| LG2 | Lithium type | Mineral oil + Synthetic hydrocarbon oil | 30 | -10 to 80 | • Low duct emission grease for clean room application |
| LGU | Diurea type | Synthetic hydrocarbon oil | 100 | -30 to 120 | • Low dust emission grease for high temperature, clean room application |

8 Dust proofing

Side seal: Provided to both sides of the ball slide as a standard feature.

Bottom seal function: A labyrinth structure of the ball slide bottom face functions as sealing effect.

NSK K1™: Lubrication unit. Tables 11 and 12 shows the related dimensions when attaching NSK K1™.

Table 11 Dimensions when attaching NSK K1 (PU series) Unit: mm

| Model No. | Ball slide length when attaching two NSK K1s, L | Thickness of single NSK K1, V ₁ | Thickness of protection cover, V ₂ |
|-----------|---|--|---|
| PU05TR | 24.4 | 2 | 0.5 |
| PU07AR | 29.4 | 2.5 | 0.5 |
| PU09TR | 36.4 | 2.7 | 0.5 |
| PU12TR | 42 | 3 | 0.5 |
| PU15AL | 51.2 | 3.5 | 0.6 |

Table 12 Dimensions when attaching NSK K1 (PE series) Unit: mm

| Model No. | Ball slide length when attaching two NSK K1s, L | Thickness of single NSK K1, V ₁ | Thickness of protection cover, V ₂ |
|-----------|---|--|---|
| PE05AR | 28.9 | 2 | 0.4 |
| PE07TR | 37.1 | 2.5 | 0.5 |
| PE09TR | 46.8 | 3 | 0.5 |
| PE12AR | 53 | 3.5 | 0.5 |
| PE15AR | 66.2 | 4 | 0.8 |

* Ball slide length when attaching NSK K1 = ("Standard ball slide length") + ("Thickness of single NSK K1, V₁ × Numbers of NSK K1s) + ("Thickness of protection cover", V₂ × 2)

9 Dimensions

9.1 Rail and ball slide assembly (preloaded type, interchangeable type)

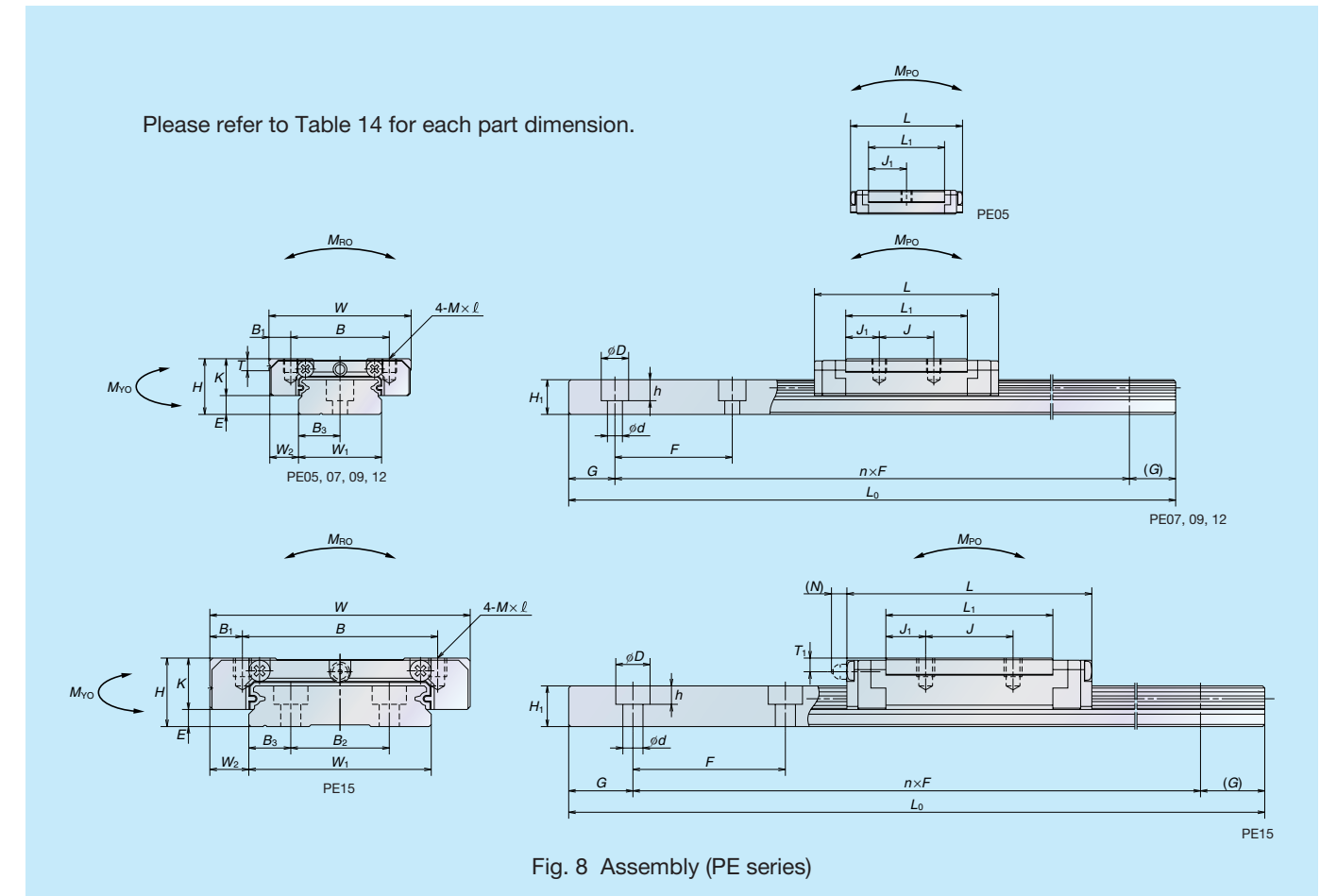
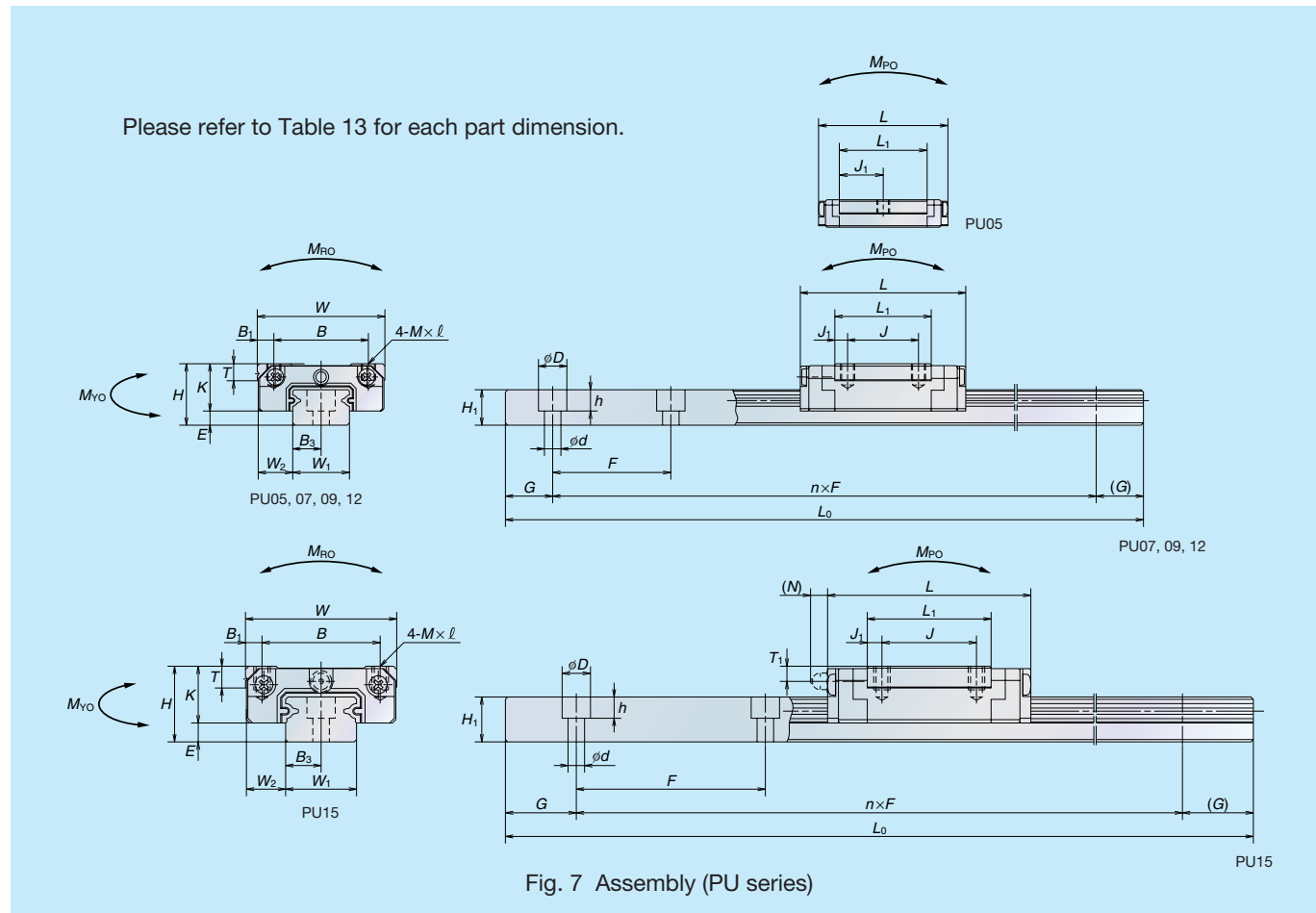

Table 10 Dimensions (PU series)

| Model No. | Assembly | | | Ball slide | | | | | | | | | | Rail | | | | | Basic load rating (*) | | | | | Ball diameter D _W | Weight | | | | | | |
|-----------|-------------|-----|----------------|------------|-------------|-------------------|----|------------|----------------|----------------|----------------|-----|------|----------------|----------------|-------|-------------------------|--------------------------|-----------------------|-----------------------------|----------------|--------------------|-------------------------------------|---------------------------------|-----------------|------------------------------|---------------------|-----------------|--------|-------------------|-------------------|
| | Height H | E | W ₂ | Width W | Length L | Mounting tap hole | | | B ₁ | L ₁ | J ₁ | K | T | Grease fitting | | | Width W ₁ | Height H ₁ | Pitch F | Mounting bolt hole d×D×h | B ₃ | G (recommended) | Maximum length L _{0max} | | Dynamic C(N) | Static C ₀ (N) | Static moment (N·m) | | | Ball slide (g) | Rail (g/100mm) |
| | | | | | | B | J | M×Pitch×l | | | | | | Port diameter | T ₁ | N | | | | | | | | M _{R0} | | | M _{P0} | M _{Y0} | | | |
| PU05TR | 6 | 1 | 3.5 | 12 | 19.4 | 8 | — | M2×0.4×1.5 | 2 | 11.4 | 5.7 | 5 | 2.3 | — | — | — | 5 | 3.2 | 15 | 2.3×3.3×0.8 | 2.5 | 5 | 210 | 520 | 775 | 2 | 1 | 1 | 1 | 4 | 11 |
| PU07AR | 8 | 1.5 | 5 | 17 | 23.4 | 12 | 8 | M2×0.4×2.4 | 2.5 | 13.3 | 2.65 | 6.5 | 2.45 | — | — | — | 7 | 4.7 | 15 | 2.4×4.2×2.3 | 3.5 | 5 | 375 | 1 090 | 1 370 | 5 | 3 | 3 | 1.5875 | 8 | 23 |
| PU09TR | 10 | 2.2 | 5.5 | 20 | 30 | 15 | 10 | M3×0.5×3 | 2.5 | 19.6 | 4.8 | 7.8 | 2.6 | — | — | — | 9 | 5.5 | 20 | 3.5×6×4.5 | 4.5 | 7.5 | 600 | 1 490 | 2 150 | 10 | 6 | 6 | 1.5875 | 16 | 35 |
| PU12TR | 13 | 3 | 7.5 | 27 | 35 | 20 | 15 | M3×0.5×3.5 | 3.5 | 20.4 | 2.7 | 10 | 3.4 | — | — | — | 12 | 7.5 | 25 | 3.5×6×4.5 | 6 | 10 | 800 | 2 830 | 3 500 | 21 | 11 | 11 | 2.3812 | 32 | 65 |
| PU15AL | 16 | 4 | 8.5 | 32 | 43 | 25 | 20 | M3×0.5×5 | 3.5 | 26.2 | 3.1 | 12 | 4.4 | φ3 | 3.2 | (3.3) | 15 | 9.5 | 40 | 3.5×6×4.5 | 7.5 | 15 | 1 000 | 5 550 | 6 600 | 50 | 26 | 26 | 3.175 | 59 | 105 |

(*)The basic load rating complies with ISO standards.

Table 11 Dimensions (PE series)

| Model No. | Assembly | | | Ball slide | | | | | | | | | | Rail | | | | | Basic load rating (*) | | | | | Ball diameter D _W | Weight | | | | | | | |
|-----------|-------------|-----|----------------|------------|-------------|-------------------|----|---------------|----------------|----------------|----------------|-----|-----|----------------|----------------|-------|-------------------------|--------------------------|-----------------------|-----------------------------|----------------|--------------------|-------------------------------------|---------------------------------|-----------------|------------------------------|---------------------|-----------------|----|-------------------|-------------------|-----|
| | Height H | E | W ₂ | Width W | Length L | Mounting tap hole | | | B ₁ | L ₁ | J ₁ | K | T | Grease fitting | | | Width W ₁ | Height H ₁ | Pitch F | Mounting bolt hole d×D×h | B ₃ | G (recommended) | Maximum length L _{0max} | | Dynamic C(N) | Static C ₀ (N) | Static moment (N·m) | | | Ball slide (g) | Rail (g/100mm) | |
| | | | | | | B | J | M×Pitch×l | | | | | | Port diameter | T ₁ | N | | | | | | | | M _{R0} | | | M _{P0} | M _{Y0} | | | | |
| PE05AR | 6.5 | 1.4 | 3.5 | 17 | 24.1 | 13 | — | M2.5×0.45×1.5 | 2 | 16.4 | 8.2 | 5.1 | 2.5 | — | — | — | 10 | 4 | — | 20 | 3×5×1.6 | 5 | 7.5 | 150 | 690 | 1 160 | 6 | 3 | 3 | 1 | 7 | 34 |
| PE07TR | 9 | 2 | 5.5 | 25 | 31.1 | 19 | 10 | M3×0.5×2.8 | 3 | 20.8 | 5.4 | 7 | 3 | — | — | — | 14 | 5.2 | — | 30 | 3.5×6×3.2 | 7 | 10 | 600 | 1 580 | 2 350 | 17 | 7 | 7 | 1.5875 | 19 | 55 |
| PE09TR | 12 | 4 | 6 | 30 | 39.8 | 21 | 12 | M3×0.5×3 | 4.5 | 26.6 | 7.3 | 8 | 2.8 | — | — | — | 18 | 7.5 | — | 30 | 3.5×6×4.5 | 9 | 10 | 800 | 3 000 | 4 500 | 37 | 17 | 17 | 2 | 35 | 95 |
| PE12AR | 14 | 4 | 8 | 40 | 45 | 28 | 15 | M3×0.5×4 | 6 | 31 | 8 | 10 | 3.2 | — | — | — | 24 | 8.5 | — | 40 | 4.5×8×4.5 | 12 | 15 | 1 000 | 4 350 | 6 350 | 71 | 29 | 29 | 2.3812 | 66 | 140 |
| PE15AR | 16 | 4 | 9 | 60 | 56.6 | 45 | 20 | M4×0.7×4.5 | 7.5 | 38.4 | 9.2 | 12 | 4.1 | φ3 | 3.2 | (3.3) | 42 | 9.5 | 23 | 40 | 4.5×8×4.5 | 9.5 | 15 | 1 200 | 7 600 | 10 400 | 207 | 59 | 59 | 3.175 | 140 | 275 |

(*)The basic load rating complies with ISO standards.

9.2 Interchangeable type

(1) Ball slide of interchangeable types

Please refer to Table 13 for each part dimension.

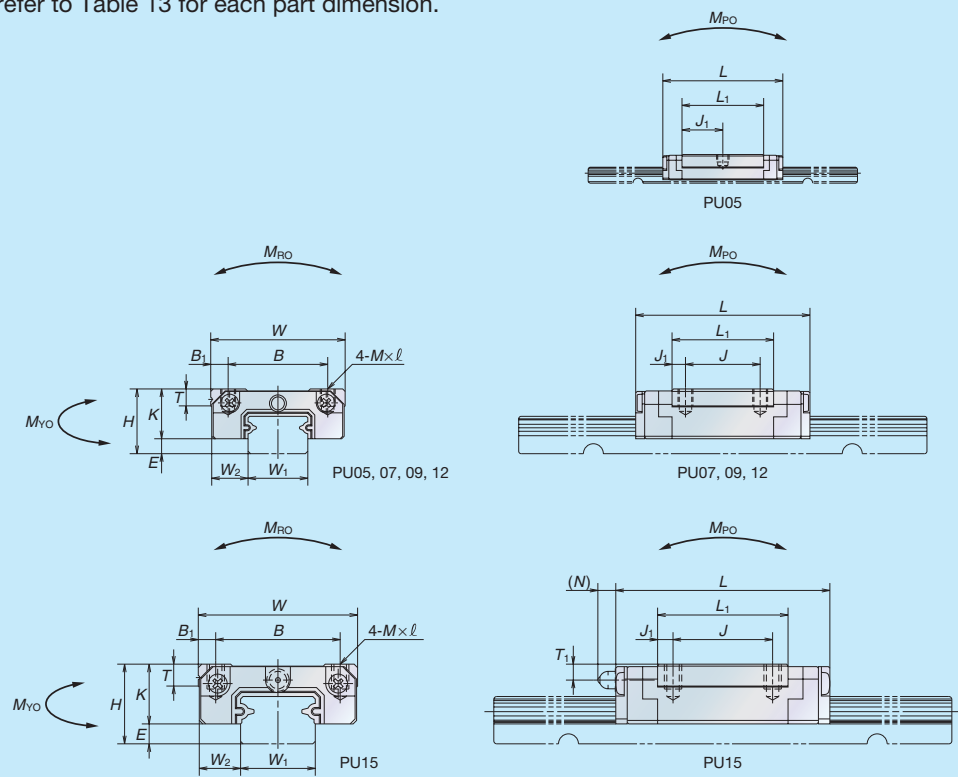

Fig. 9 Ball slide of interchangeable types (PU series)

Please refer to Table 14 for each part dimension.

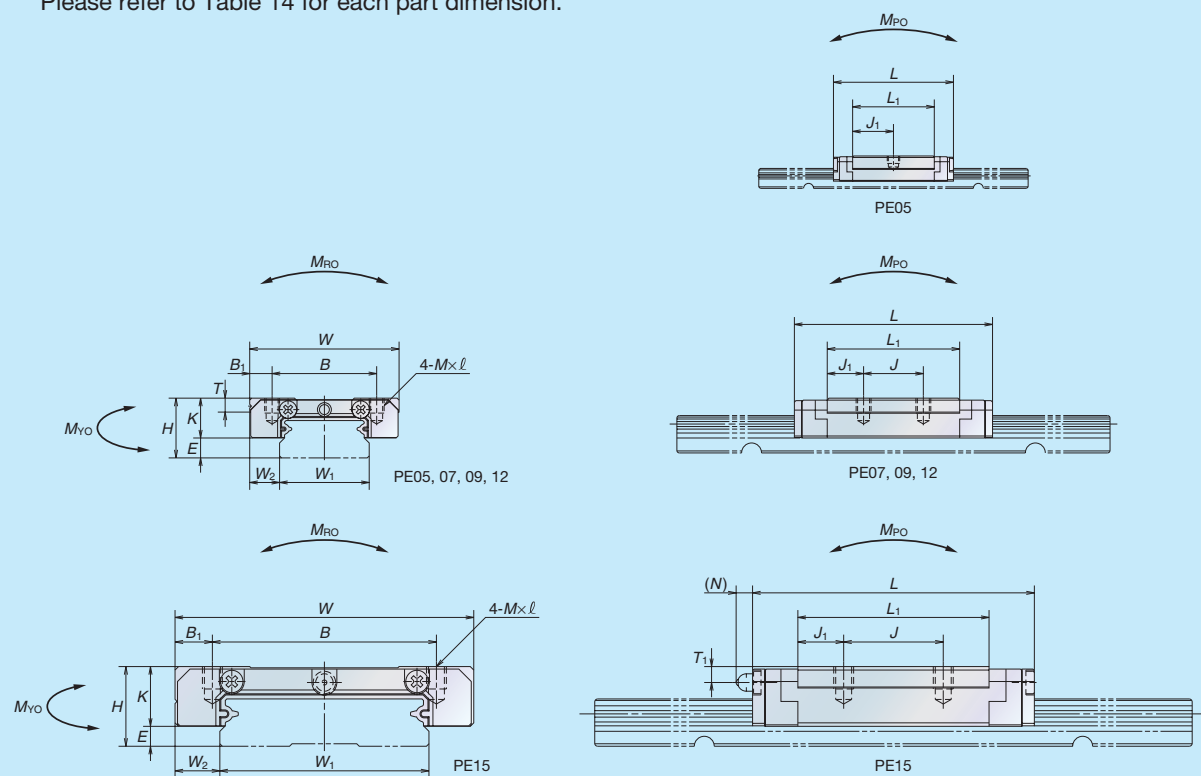

Fig. 10 Ball slide of interchangeable types (PE series)

(2) Rail of interchangeable types

Please refer to Table 13 for each part dimension.

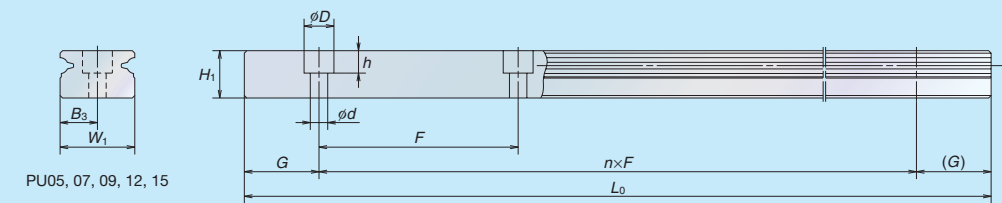

Fig. 11 Rail of interchangeable types (PU series)

Please refer to Table 14 for each part dimension.

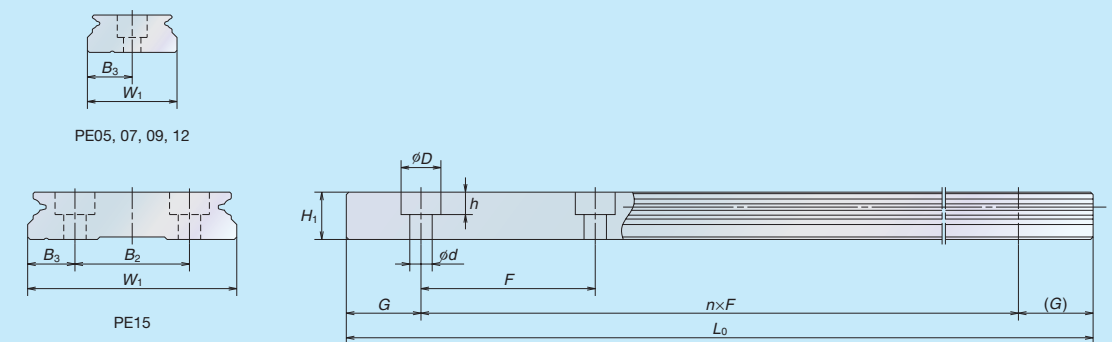

Fig. 12 Rail of interchangeable types (PE series)

10 Interchangeability with LU series/LE series

The PU series/PE series is designed to be interchangeable with the LU series/LE series for its mounting dimensions and load ratings(*).

Refer to Figs. 7, 8 and Tables 13, 14 for more details.

(*) Not including load rating of PU05 and PE05.

11 Handling precautions

- (1) Resin parts such as the end cap may become damaged when struck or hit.
- (2) Maximum operating temperature must be 80°C or below. Exceeding this limit may damage resin parts.
- (3) Maximum operating temperature must be 50°C (max. momentary 80°C) when attaching NSK K1®. Also, avoid exposure to organic solvents with a degreasing effect. Do not immerse in kerosene or rust preventative oil (with kerosene ingredients).
- (4) Handling of interchangeable types
 - ① Interchangeable ball slide will be delivered with a provisional rail (inserting fixture).
 - ② Be sure to use the provisional rail when removing ball slide(s) from a rail.
 - ③ Do not remove the ball slide from provisional rail until inserting into a rail.