



**ROLLING
BEARINGS**
for
**INDUSTRIAL
MACHINERY**

Part A 1.TYPES AND FEATURES OF ROLLING BEARINGS

2.SELECTION OF BEARING TYPE

3.SELECTION OF BEARING ARRANGEMENT

4.SELECTION OF BEARING SIZE

5.SPEEDS

6.BOUNDARY DIMENSIONS AND BEARING DESIGNATIONS

7.BEARING TOLERANCES

8.FITS AND INTERNAL CLEARANCES

9.PRELOAD

10.FRCTION

11.LUBRICATION

12.BEARING MATERIALS

13.DESIGN OF SHAFTS AND HOUSINGS

Part B 1.BEARING HANDLING

2.BEARING DAMAGE AND COUNTERMEASURES (Bearing Doctor)

Part C 1.DEEP GROOVE BALL BEARINGS

2.EXTRA SMALL BALL BEARINGS AND MINIATURE BALL BEARINGS

3.ANGULAR CONTACT BALL BEARINGS

4.SELF-ALIGNING BALL BEARINGS

5.CYLINDRICAL ROLLER BEARINGS

6.TAPERED ROLLER BEARINGS

7.SPHERICAL ROLLER BEARINGS

8.THRUST BEARINGS

9.NEEDLE ROLLER BEARINGS
BALL BEARING UNITS / PLUMMER BLOCKS

10.ACCESSORIES FOR ROLLING BEARINGS

Part D INDUSTRY SOLUTIONS

Part E APPENDICES

ROLLING BEARINGS
for INDUSTRIAL MACHINERY

Introduction to the Revised NSK Rolling Bearings Catalog (CAT.No.E1103)

Thank you for your interest in this edition of our *Rolling Bearings* catalog.

Rolling bearings are vital components in improving the efficiency and reliability of machines, and as technology advances, the requirements of bearings become ever more challenging.

NSK celebrated its 100th anniversary in 2016. As a leading bearing manufacturer, we have continued to make breakthroughs in the research and development of bearings alongside our customers and have actively contributed to the advancement of society and the preservation of the environment.

This catalog is a culmination of all our technological expertise acquired over our 100-year history and is intended to provide you with all the information necessary to make your bearing selection, no matter the application.

The catalog is divided into five parts, labelled A through E. Part A contains general information for bearing selection. Part B provides information on bearing handling. Part C lists product information relating to bearing type and dimensions, where you can also find information on our new High Performance Standard Bearing Series (NSKHPS™). Part D covers industry-related product information. Lastly, part E contains appendices with reference information and conversion tables.

We hope this catalog provides you with all the information you need to select the optimal bearing for your application. However, please don't hesitate to contact us should you require any assistance.

CONTENTS

Part A
TECHNICAL INFORMATION

	Pages		Pages
1 TYPES AND FEATURES OF ROLLING BEARINGS	A 005	6.1 Boundary Dimensions and Dimensions of Snap Ring Grooves	A 104
1.1 Design and Classification	A 006	6.2 Formulation of Bearing Designations	A 120
1.2 Characteristics of Rolling Bearings	A 006	7 BEARING TOLERANCES	A 125
1.3 Contact Angle and Bearing Types	A 016	7.1 Bearing Tolerance Standards	A 126
1.4 Types of Load on Bearings	A 017	7.2 Selection of Tolerance Classes	A 151
2 SELECTION OF BEARING TYPE	A 019	8 FITS AND INTERNAL CLEARANCES	A 153
2.1 Bearing Selection Procedure	A 020	8.1 Fits	A 154
2.2 Allowable Bearing Space	A 022	8.2 Bearing Internal Clearances	A 168
2.3 Load Capacity and Bearing Types	A 022	8.3 Technical Data	A 176
2.4 Permissible Speed and Bearing Types ..	A 022	9 PRELOAD	A 191
2.5 Misalignment of Inner/Outer Rings and Bearing Types	A 022	9.1 Purpose of Preload	A 192
2.6 Rigidity and Bearing Types	A 023	9.2 Preloading Methods	A 192
2.7 Noise and Torque of Various Bearing Types	A 023	9.3 Preload and Rigidity	A 192
2.8 Running Accuracy and Bearing Types ..	A 023	9.4 Selection of Preloading Method and Amount of Preload	A 193
2.9 Mounting and Dismounting of Various Bearing Types	A 023	9.5 Amount of Preload	A 194
3 SELECTION OF BEARING ARRANGEMENT	A 025	9.6 Technical Data	A 200
3.1 Fixed-End and Free-End Bearings	A 026	10 FRICTION	A 215
3.2 Example Bearing Arrangements	A 027	10.1 Coefficients of Dynamic Friction	A 216
4 SELECTION OF BEARING SIZE	A 030	10.2 Empirical Equations for Running Torque	A 216
4.1 Bearing Life	A 032	10.3 Technical Data	A 216
4.2 Basic Load Rating and Fatigue Life	A 032	11 LUBRICATION	A 227
4.3 Calculation of Bearing Loads	A 044	11.1 Purposes of Lubrication	A 228
4.4 Equivalent Load	A 050	11.2 Lubricating Methods	A 228
4.5 Static Load Ratings and Static Equivalent Loads	A 052	11.3 Lubricants	A 236
4.6 Example Bearing Calculations	A 054	11.4 Technical Data	A 240
4.7 Bearing Type and Allowable Axial Load	A 058	12 BEARING MATERIALS	A 243
4.8 Technical Data	A 066	12.1 Materials for Bearing Rings and Rolling Elements	A 244
5 SPEEDS	A 097	12.2 Cage Materials	A 245
5.1 Limiting Speed (Grease/Oil)	A 098	12.3 Characteristics of Bearing, Shaft, and Housing Materials	A 246
5.2 Thermal Reference Speed	A 099	12.4 Technical Data	A 248
5.3 Limiting Speed (Mechanical)	A 099	13 DESIGN OF SHAFTS AND HOUSINGS	A 269
5.4 Technical Data	A 100	13.1 Accuracy and Surface Finish of Shafts and Housings	A 270
6 BOUNDARY DIMENSIONS AND BEARING DESIGNATIONS	A 103	13.2 Shoulder and Fillet Dimensions	A 270
		13.3 Bearing Seals	A 272

Part B
BEARING HANDLING AND MAINTENANCE

	Pages
1 BEARING HANDLING	B 005
1.1 Precautions for Proper Handling of Bearings	B 006
1.2 Bearing Storage	B 006
1.3 Mounting	B 006
1.4 Operation Inspection	B 008
1.5 Dismounting	B 011
1.6 Inspection of Bearings	B 013
1.7 Checking the Shaft and Housing	B 014
1.8 Maintenance and Inspection	B 017
2 BEARING DAMAGE AND COUNTERMEASURES (Bearing Doctor)	B 021
2.1 Bearing Damage	B 022
2.2 Running Traces and Applied Loads	B 022
2.3 Bearing Damage and Countermeasures ..	B 024
Appendix : Bearing Diagnostic Chart	B 052

Part C
BEARING TABLES

1 DEEP GROOVE BALL BEARINGS	C 005
2 EXTRA SMALL BALL BEARINGS AND MINIATURE BALL BEARINGS	C 053
3 ANGULAR CONTACT BALL BEARINGS	C 071
4 SELF-ALIGNING BALL BEARINGS	C 115
5 CYLINDRICAL ROLLER BEARINGS	C 125
6 TAPERED ROLLER BEARINGS	C 181
7 SPHERICAL ROLLER BEARINGS	C 257
8 THRUST BALL BEARINGS	C 295
9 THRUST CYLINDRICAL ROLLER BEARINGS	C 313
10 THRUST TAPERED ROLLER BEARINGS	C 321
11 THRUST SPHERICAL ROLLER BEARINGS ..	C 331
12 NEEDLE ROLLER BEARINGS	C 341
13 BALL BEARING UNITS	C 343
14 PLUMMER BLOCKS	C 345
15 ACCESSORIES FOR ROLLING BEARINGS ..	C 347

Part D
INDUSTRY SOLUTIONS

	Pages
1 AIR TURBINE BEARINGS FOR DENTAL HANDPIECES	D 004
2 PUMPS & COMPRESSORS	D 010
3 AGRICULTURAL MACHINERY	D 026
4 CONSTRUCTION MACHINERY	D 034
5 MINING MACHINERY	D 040
6 RAILWAY ROLLING STOCK	D 048
7 PAPERMAKING MACHINES	D 066
8 WIND POWER INDUSTRY	D 086
9 STEEL INDUSTRY	D 094

Part E
APPENDICES

E 001

TECHNICAL INFORMATION

Part A

TECHNICAL INFORMATION

1. TYPES AND FEATURES OF ROLLING BEARINGS	A 005
2. SELECTION OF BEARING TYPES	A 019
3. SELECTION OF BEARING ARRANGEMENT	A 025
4. SELECTION OF BEARING SIZE	A 030
5. SPEEDS	A 097
6. BOUNDARY DIMENSIONS AND IDENTIFYING NUMBERS FOR BEARINGS	A 103
7. BEARING TOLERANCES	A 125
8. FITS AND INTERNAL CLEARANCES	A 153
9. PRELOAD	A 191
10. FRICTION	A 215
11. LUBRICATION	A 227
12. BEARING MATERIALS	A 243
13. DESIGN OF SHAFTS AND HOUSINGS	A 269



1. TYPES AND FEATURES OF ROLLING BEARINGS

1.1 Design and Classification	A 006
1.2 Characteristics of Rolling Bearings	A 006
1.3 Contact Angle and Bearing Types	A 016
1.4 Types of Load on Bearings	A 017



1. TYPES AND FEATURES OF ROLLING BEARINGS

1.1 Design and Classification

Rolling bearings generally consist of rolling elements, two rings, and a cage. They are classified into radial bearings or thrust bearings depending on the direction of the main load. In addition, depending on the type of rolling elements, they are classified into ball bearings or roller bearings and further divided by differences in their design or specific purpose. The most common bearing types and part names are shown in Fig. 1.1, and a general classification of rolling bearings is shown in Fig. 1.2.

1.2 Characteristics of Rolling Bearings

Compared with plain bearings, rolling bearings have the following major advantages:

- (1) Their starting torque or friction is low and the difference between the starting torque and running torque is small.
- (2) With the advancement of worldwide standardization, rolling bearings are internationally available and interchangeable.
- (3) Maintenance, replacement, and inspection are easy because of the simple structure surrounding rolling bearings.
- (4) Many rolling bearings are capable of taking both radial and axial loads simultaneously or independently.
- (5) Rolling bearings can be used under a wide range of temperatures.
- (6) Rolling bearings can be preloaded to produce a negative clearance and achieve greater rigidity.

Furthermore, different types of rolling bearings have their own individual advantages. The features of the most common rolling bearings are described on Pages A010 to A013 and in Table 1.1 (Pages A014 and A015).

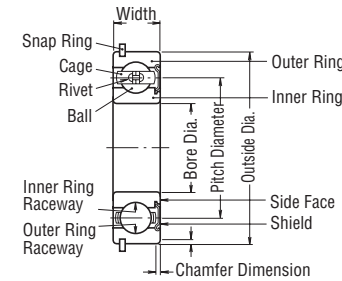

Single-Row Deep Groove Ball Bearing

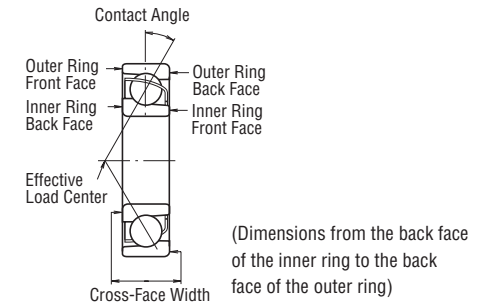

Single-Row Angular Contact Ball Bearing

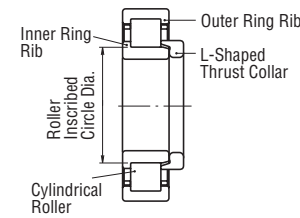

Cylindrical Roller Bearing

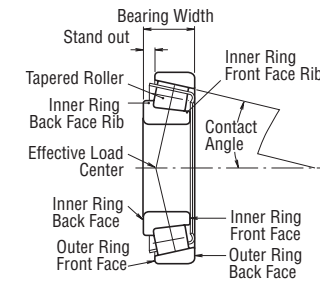

Tapered Roller Bearing

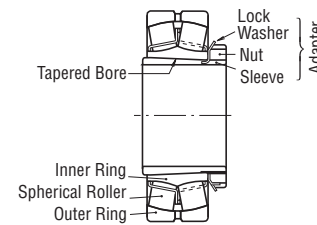

Spherical Roller Bearing

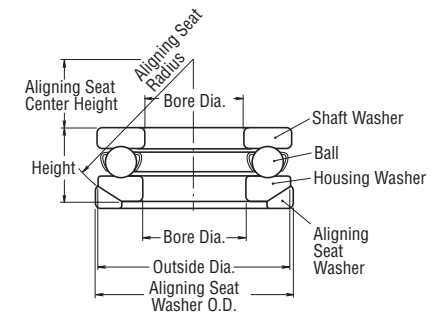

Single-Direction Thrust Ball Bearing

Fig. 1.1 Names of Bearing Parts

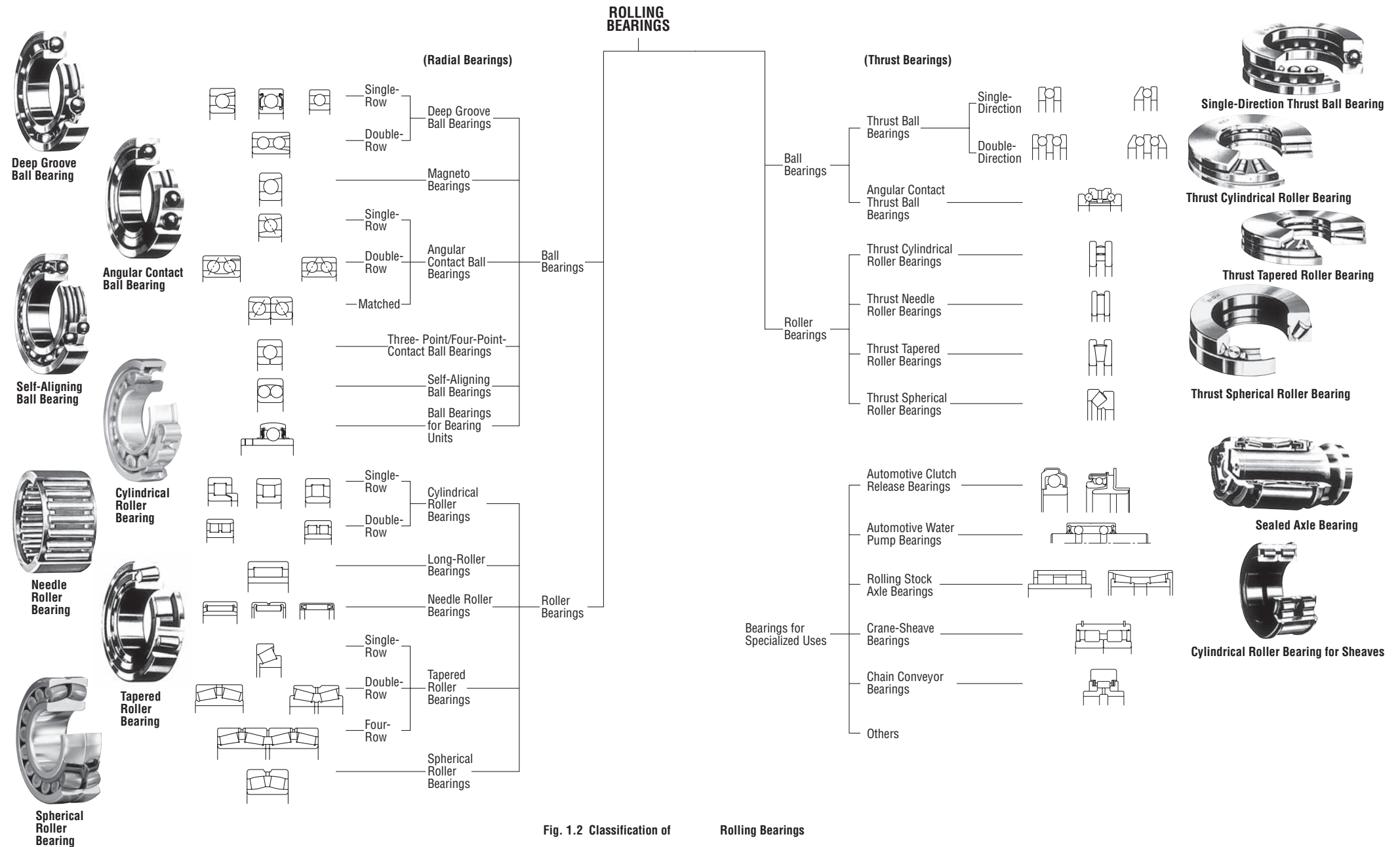

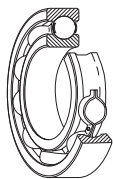
TYPES AND FEATURES OF ROLLING BEARINGS
Single-Row Deep Groove Ball Bearings

Single-row deep groove ball bearings are the most common type of rolling bearing and are in widespread use. The raceway grooves on both the inner and outer rings have circular arcs of slightly larger radii than those of the balls. They are capable of taking radial loads. In addition, axial loads can be applied in either direction. Because of their low torque, they are highly suitable for applications where high speeds and low power loss are required.

While they can be used as open bearings, single-row deep groove bearings often have steel shields or rubber seals installed on one or both sides and are prelubricated with grease. In addition, snap rings are sometimes used on the periphery. Pressed-steel cages are most commonly used.

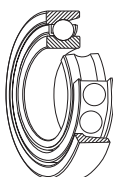
Magneto Bearings

The inner groove of magneto bearings is slightly more shallow than that of deep groove bearings. Since the outer ring has a shoulder on only one side, the outer ring may be removed, which is often advantageous for mounting. In general, two such bearings are used in a paired mounting. Magneto bearings are small bearings with a bore diameter of 4 to 20 mm and are mainly used for small magnetos, gyroscopes, instruments, etc. Pressed-brass cages are generally used.

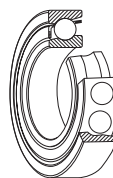
Single-Row Angular Contact Ball Bearings

Individual bearings of this type are capable of taking axial loads in one direction and radial loads. Four contact angles of 15°, 25°, 30°, and 40° are available. The larger the contact angle, the higher the axial load capacity. For high-speed operation however, smaller contact angles are preferred. Usually, two bearings are used in a paired mounting, and the clearance between them must be adjusted properly.

Pressed-steel and machined-brass cages are commonly used; however, for high precision bearings with a contact angle less than 30°, polyamide resin cages are often used.

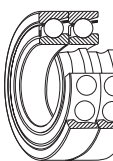
Paired Mounting

A combination of two radial bearings is called a paired mounting. Usually, they are formed using angular contact ball bearings or tapered roller bearings. Possible arrangements include: face-to-face (type DF), in which the outer ring faces are oriented towards each other; back-to-back (type DB); or same-direction (type DT), in which both front faces are oriented in the same direction. DF and DB arrangements are capable of taking radial loads and axial loads in both directions. Type DT is used when there is a strong axial load in one direction and it is necessary to divide the load equally across each bearing.

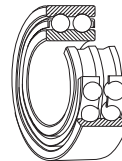
Double-Row Angular Contact Ball Bearings

Double-row angular contact ball bearings are like two single-row angular contact ball bearings mounted back-to-back, except that they have only one inner ring and one outer ring. They have a narrower width than two single bearings, and can take thrust loads in both directions.

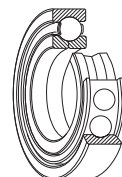
Four-Point-Contact Ball Bearings

The inner and outer rings of four-point-contact ball bearings are separable because the inner ring is split in a radial plane. They can take axial loads from either direction, and the balls have a contact angle of 35° with each ring. Radial loads are not recommended. Just one bearing of this type can replace a combination of face-to-face or back-to-back angular contact bearings. Machined-brass cages are generally used.

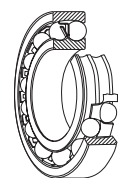
Self-Aligning Ball Bearings

The inner ring of this type of bearing has two raceways, and the outer ring has a single spherical raceway with its center of curvature coincident with the bearing axis. Therefore, the axis of the inner ring, balls, and cage can deflect to some extent around the bearing center. Consequently, minor angular misalignment of the shaft and housing caused by machining or mounting error is automatically corrected.

This type of bearing often has a tapered bore for mounting using an adapter sleeve.

Cylindrical Roller Bearings

In bearings of this type, the cylindrical rollers are in linear contact with the raceways. They have a high radial load capacity and are suitable for high speeds.

NU, NJ, NUP, N, and NF are single-row bearing types, while NNU and NN are double-row bearing types, with designations depending on the design or absence of side ribs. The outer and inner rings of all types are separable.

Some cylindrical roller bearings have no ribs on either the inner or outer ring, so that the rings can move axially relative to each other. These can be used as free-end bearings. Cylindrical roller bearings, in which either the inner or outer ring has two ribs and the other ring has one, are capable of taking some axial load in one direction. Double-row cylindrical roller bearings have high radial rigidity and are used primarily for precision machine tools.

Pressed steel or machined brass cages are generally used, but sometimes molded polyamide cages are employed.

■ TYPES AND FEATURES OF ROLLING BEARINGS

Needle Roller Bearings

Needle roller bearings contain many slender rollers with a length 3 to 10 times their diameter. As a result, the ratio of the bearing outside diameter to the inscribed circle diameter is small, and they have a rather high radial load capacity.

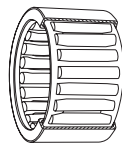

There are numerous types available, and many have no inner ring. The drawn-cup type has a pressed-steel outer ring and the solid type has a machined outer ring. There are also cage and roller assemblies without rings. Most bearings have pressed-steel cages, but some do not use cages.

Tapered Roller Bearings

Bearings of this type use conical rollers guided by a back-face rib on the inner ring. These bearings are capable of taking high radial loads and also axial loads in one direction. The HR Series features a greater quantity of larger rollers, allowing for even higher load capacity.

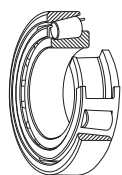

They are generally mounted in pairs in a manner similar to single-row angular contact ball bearings. In this case, the proper internal clearance can be obtained by adjusting the axial distance between the inner or outer rings of the two opposed bearings. Since they are separable, the inner ring assemblies and outer rings can be mounted independently.

Tapered roller bearings are divided into three types depending on contact angle; these are normal angle, medium angle, and steep angle. Double-row and four-row tapered roller bearings are also available. Pressed-steel cages are generally used.

Spherical Roller Bearings

These bearings have barrel-shaped rollers between the inner ring, which has two raceways, and the outer ring, which has one spherical raceway. Since the center of curvature of the outer ring raceway surface coincides with the bearing axis, they are self-aligning in a manner similar to that of self-aligning ball bearings. Therefore, if there is deflection of the shaft or housing or misalignment of their axes, it is automatically corrected so that excessive force is not applied to the bearings.

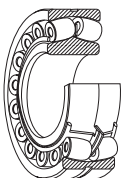

Spherical roller bearings can take not only heavy radial loads, but also some axial loads in either direction. They have excellent radial load-carrying capacity and are suitable for use where there are heavy or impact loads.

Some bearings have tapered bores and may be mounted directly on tapered shafts or cylindrical shafts using adapters or withdrawal sleeves. Pressed-steel and machined-brass cages are used.

Single-Direction Thrust Ball Bearings



Single-direction thrust ball bearings are composed of washer-like bearing rings with raceway grooves. The ring attached to the shaft is called the shaft washer (or inner ring) while the ring attached to the housing is called the housing washer (or outer ring).

Double-Direction Thrust Ball Bearings

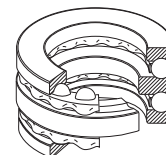

Double-direction thrust ball bearings have three rings with the middle ring (center ring) fixed to the shaft.

As their names imply, single-direction thrust bearings can take axial loads in one direction, while double-direction thrust bearings can take axial loads in both directions.

There are also thrust ball bearings with an aligning seat washer beneath the housing washer in order to compensate for shaft misalignment or mounting error.

Pressed-steel cages are usually used in smaller bearings and machined cages in larger bearings.

Spherical Thrust Roller Bearings



These bearings have a spherical raceway in the housing washer and barrel-shaped rollers obliquely arranged around it. Since the raceway in the housing washer is spherical, these bearings are self-aligning. They have a very high axial load capacity and are capable of taking moderate radial loads when an axial load is applied.

Pressed-steel cages or machined-brass cages are usually used.

Table 1. 1 Types and Characteristics

Bearing Type	Deep Groove Ball Bearings	Magneto Bearings	Angular Contact Ball Bearings	Double-Row Angular Contact Ball Bearings	Duplex Angular Contact Ball Bearings	Four-Point-Contact Ball Bearings	Self-Aligning Ball Bearings	Cylindrical Roller Bearings	Double-Row Cylindrical Roller Bearings	Cylindrical Roller Bearings with Single Rib
Load Capacity	Radial Loads	○	◎	◎	◎	○	◎	◎	◎	◎
	Axial Loads	↔	←	↔	↔	↔	↔	·	·	↔
	Combined Loads	◎	○	◎	◎	◎	○	·	·	◎
High Speeds	◎	◎	◎	○	◎	◎	◎	◎	◎	◎
High Accuracy	◎		◎		◎	◎		◎	◎	
Low Noise and Torque	◎							◎		
Rigidity					◎			◎	◎	◎
Angular Misalignment	◎	○	○	○	○	○	◎	○	○	○
Self-Aligning Capability							☆			
Ring Separability		☆				☆		☆	☆	☆
Fixed-End Bearing	☆			☆	☆	☆	☆			
Free-End Bearing	★			★	★	★	★	☆	☆	
Inner Ring Tapered Bore							☆		☆	
Remarks		Two bearings are usually mounted in opposition.	Contact angles of 15°, 25°, 30° and 40°. Two bearings are usually mounted in opposition. Clearance adjustment is necessary.		Combination of DF and DT pairs is possible, but not for use on free-end.	Contact angle of 35°		Including N type	Including MNU type	Including NF type
Page No.	C005 C053	C005 C050	C072	C072 C106	C072	C072 C108	C114	C124	C124 C158	C124

Excellent
 Good
 Fair
 Poor
 · Unsuitable
 ← One direction only
 ↔ Two directions

☆ Applicable ★ Applicable, allow for shaft contraction/elongation at bearing fitting surfaces.

of Rolling Bearings

Cylindrical Roller Bearings with Thrust Collars	Needle Roller Bearings	Tapered Roller Bearings	Double- and Multi-Row Tapered Roller Bearings	Spherical Roller Bearings	Thrust Ball Bearings	Thrust Ball Bearings with Aligning Seat	Double-Direction Angular Contact Thrust Ball Bearings	Thrust Cylindrical Roller Bearings	Thrust Tapered Roller Bearings	Thrust Spherical Roller Bearings	Page No.
◎	◎	◎	◎	◎	×	×	×	×	×	○	—
↔	×	↔	↔	↔	←	←	↔	←	←	←	—
◎	×	◎	◎	◎	×	×	×	×	×	○	—
◎	◎	○	○	○	×	×	○	○	○	○	A022 A098
		◎			◎		◎				A023 A126 A151
											A023
◎	◎	◎	◎				◎	◎	◎		A023 A192
○	○	○	○	◎	×	◎	×	×	×	◎	A022 Blue pages of each brg. type
				☆		☆				☆	A022
☆	☆	☆	☆		☆	☆	☆	☆	☆	☆	A023 A024
☆			☆	☆							A026 to A029
	☆		★	★							A026 to A029
				☆							A150 B008 B012
Including NUP type		Two bearings are usually mounted in opposition. Clearance adjustment is necessary.						Including needle roller thrust bearings		To be used with oil lubrication	
C124	C341	C182	C182 C246	C258	C296	C296	—	C314	C322	C332	

■ TYPES AND FEATURES OF ROLLING BEARINGS

1.3 Contact Angle and Bearing Types

The contact angle (α) refers to the angle between a vertical plane of the rotation axis of the bearing and a straight line between the points where the rolling element comes in contact with the inner ring raceway and outer ring raceway.

Radial bearings and thrust bearings are classified depending on the size of the contact angle.

Figure 1.3 shows the relation between contact angle and loading direction on the bearing.

Radial bearing α : Less than 45°
(A primarily radial load is applied.)

Thrust bearing α : Over 45°
(A primarily axial load is applied.)

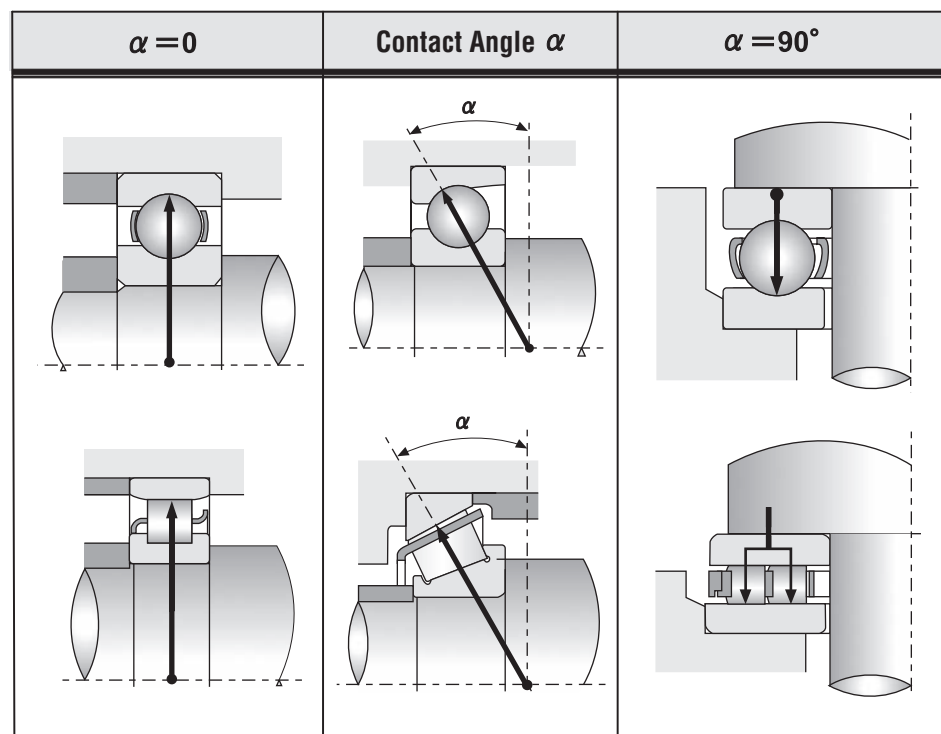

Fig. 1.3 Contact Angle α

1.4 Types of Load on Bearings

An example deep groove ball bearing is shown below in Figure 1.4 along with the types of load applied to a rolling bearing. These are:

- (a) Radial load
- (b) Axial load
- (c) Combined radial and axial load
- (d) Moment load

It is important to select the optimum bearing type according to the type and magnitude of the load.

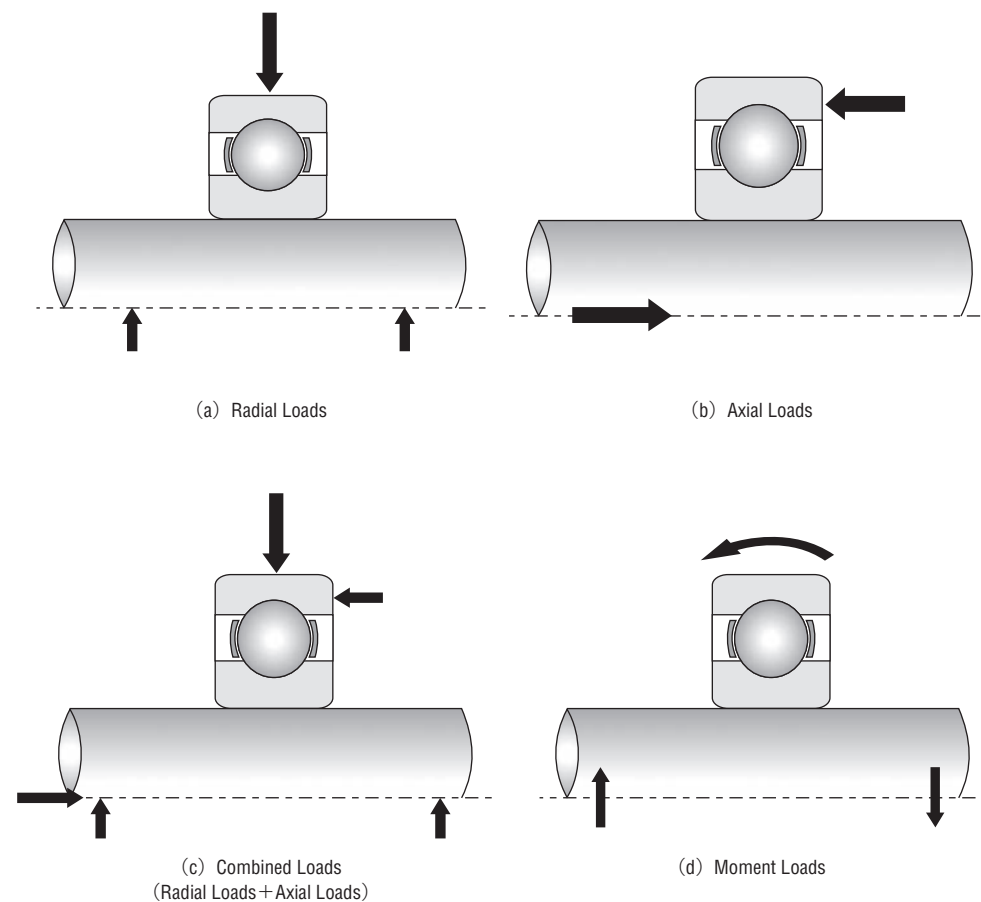

Fig. 1.4 Types of Load

2. SELECTION OF BEARING TYPE

2.1 Bearing Selection Procedure	A 020
2.2 Allowable Bearing Space	A 022
2.3 Load Capacity and Bearing Types	A 022
2.4 Permissible Speed and Bearing Types	A 022
2.5 Misalignment of Inner/Outer Rings and Bearing Types ..	A 022
2.6 Rigidity and Bearing Types	A 023
2.7 Noise and Torque of Various Bearing Types	A 023
2.8 Running Accuracy and Bearing Types	A 023
2.9 Mounting and Dismounting of Various Bearing Types	A 023



2. SELECTION OF BEARING TYPE

2.1 Bearing Selection Procedure

There are nearly countless applications for rolling bearings; therefore, operating conditions and environments vary greatly. In addition, the diversity of operating conditions and bearing requirements continues to grow with the rapid advancement of technology. Bearings must be carefully studied from many angles to select the best choice from the thousands of types and sizes available. Usually, a bearing type is provisionally chosen considering operating conditions, mounting arrangement, ease of mounting in the machine, allowable space, cost, availability, and other factors. Then the size of the bearing is chosen to satisfy the

desired life requirement. When doing this, in addition to fatigue life, be sure to consider grease life, noise and vibration, wear, and other factors. There is no fixed procedure for selecting bearings. It is good to investigate experience with similar applications and studies relevant to any special requirements for the specific application. When selecting bearings for new machines, unusual operating conditions, or harsh environments, please consult with NSK. The following diagram (Fig.2.1) shows an example bearing selection procedure.

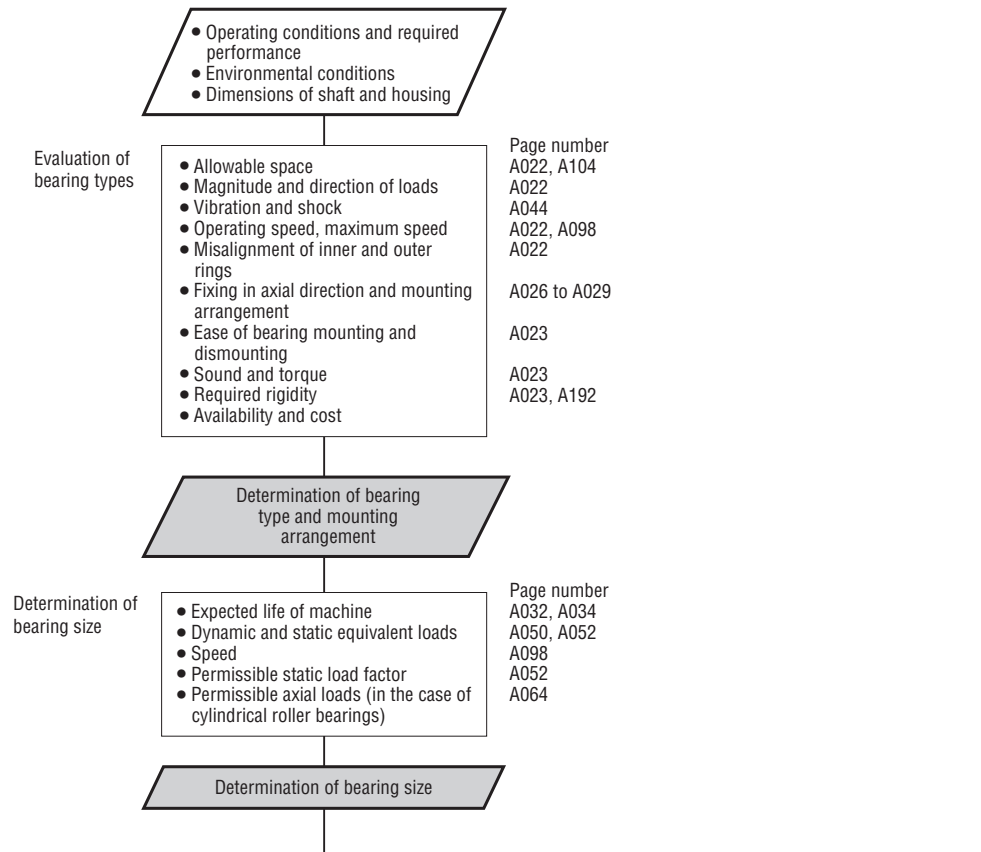
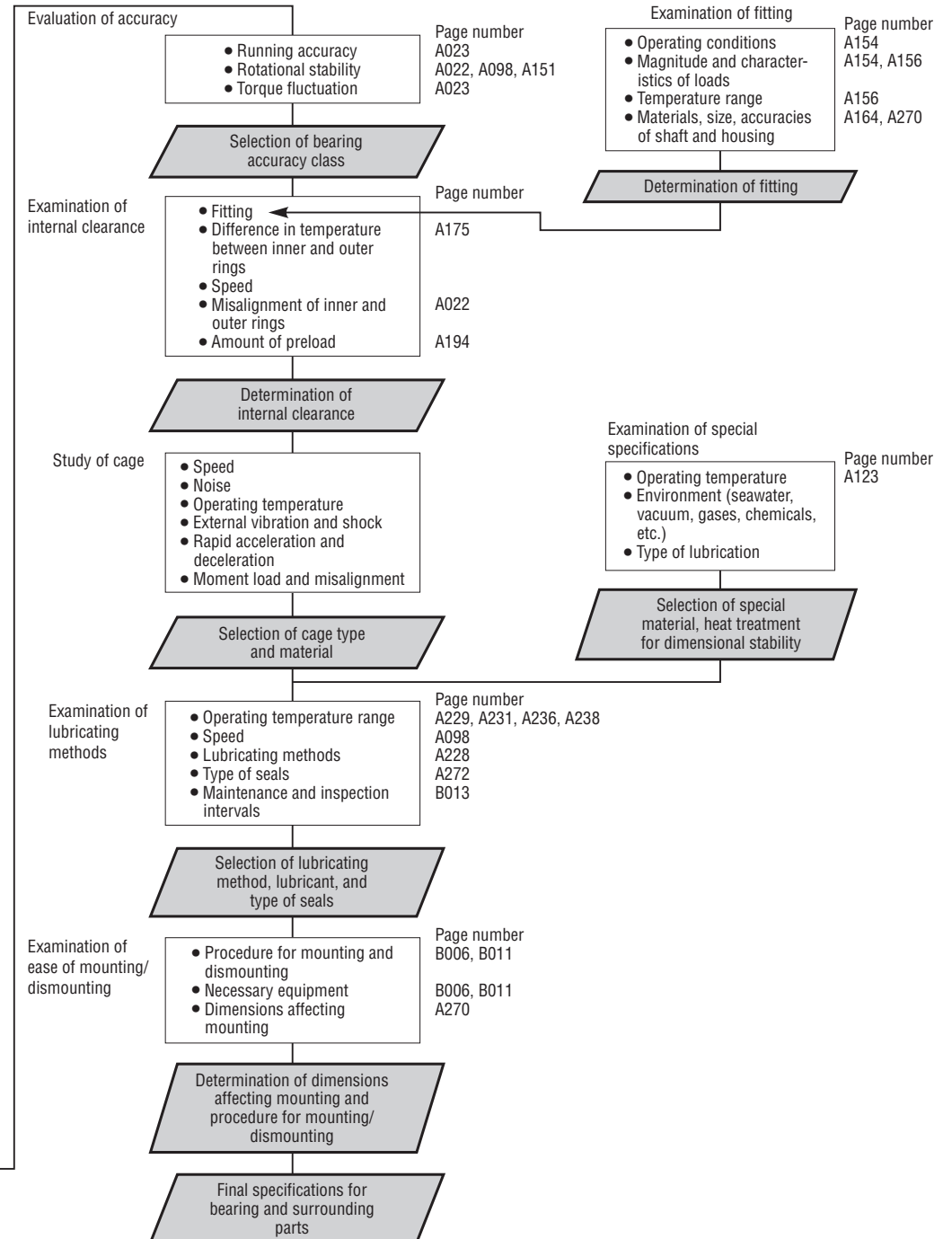

Fig. 2.1 Flowchart for Selection of Rolling Bearings



SELECTION OF BEARING TYPE

2.2 Allowable Bearing Space

The allowable space for a rolling bearing and its adjacent parts is generally limited, so the type and size of the bearing must be selected within such limits. In most cases, the shaft diameter is fixed first by the machine design; therefore, the bearing is often selected based on bore size. Rolling bearings have numerous standardized Dimension Series and types from which to select the optimum bearing. Fig. 2.2 shows the Dimension Series of radial bearings and corresponding bearing types.

2.3 Load Capacity and Bearing Types

The axial load-carrying capacity of a bearing is closely related to radial load capacity based on the bearing design, as shown in Fig. 2.3. This figure shows that when bearings of the same Dimension Series are compared, roller bearings have a higher load capacity than ball bearings and are superior if shock loads exist.

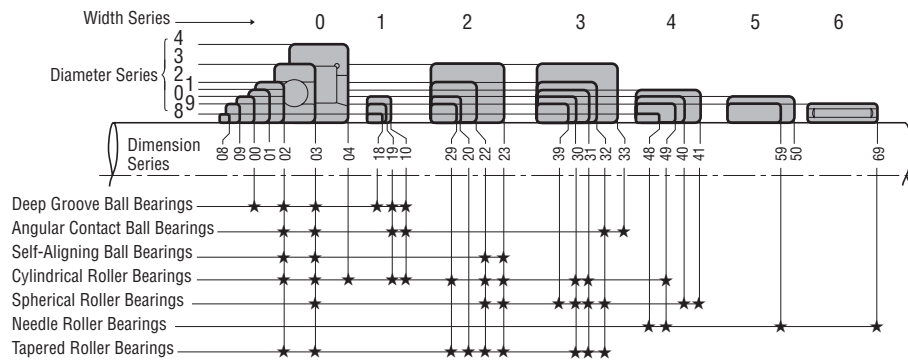

Fig. 2.2 Dimension Series of Radial Bearings

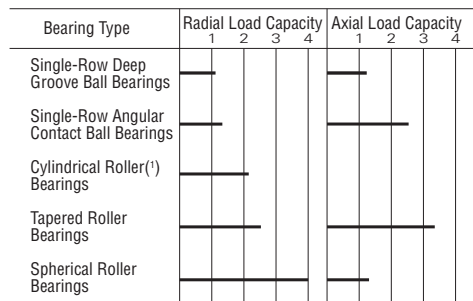

Fig. 2.3 Relative Load Capacities of Various Bearing Types

2.4 Permissible Speed and Bearing Types

The maximum speed of rolling bearings varies not only with the type of bearing, but also with size, cage type, loads, lubricating method, heat dissipation, etc. Assuming the common oil bath lubrication method, the bearing types are roughly ranked from higher speed to lower speed as shown in Fig. 2.4.

2.5 Misalignment of Inner/Outer Rings and Bearing Types

Because of shaft deflection caused by applied loads, dimensional errors of the shaft and housing, and mounting errors, the inner and outer rings are slightly misaligned. The permissible misalignment varies depending on the bearing type and operating conditions, but usually it is less than 0.0012 radian (4').

When a large misalignment is expected, bearings with self-aligning capability, such as self-aligning ball bearings, spherical roller bearings, and certain bearing units should be selected (Figs. 2.5 and 2.6).

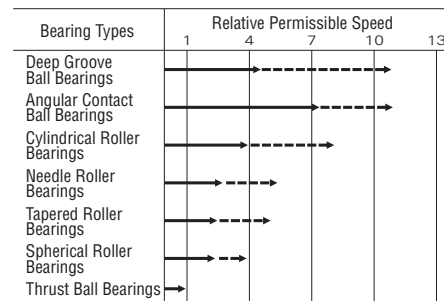

Remarks: — Oil bath lubrication
 - - - With special measures to increase speed limit

Fig. 2.4 Relative Permissible Speeds of Various Bearing Types

Permissible bearing misalignment is given at the beginning of the dimensional tables for each bearing type.

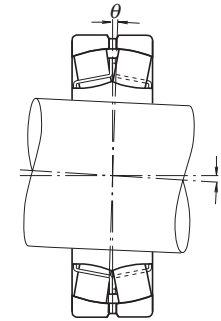

Fig. 2.5 Permissible Misalignment of Spherical Roller Bearings

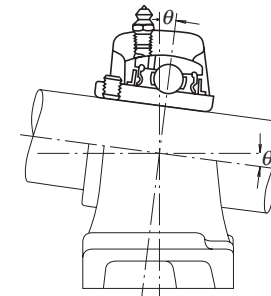

Fig. 2.6 Permissible Misalignment of Ball Bearing Units

2.6 Rigidity and Bearing Types

When loads are imposed on a rolling bearing, some elastic deformation occurs in the contact areas between the rolling elements and raceways. The rigidity of the bearing is determined by the ratio of bearing load to the amount of elastic deformation of the inner and outer rings and rolling elements. The main spindles of machine tools must have highly rigid bearings together with the rest of the spindle. Consequently, since roller bearings are deformed less by load, they are selected more often than ball bearings. When extra-high rigidity is required, bearings are given a preload, which means they have a negative clearance. Angular contact ball bearings and tapered roller bearings are often preloaded.

2.7 Noise and Torque of Various Bearing Types

Since rolling bearings are manufactured with very high precision, noise and torque are minimal. For deep groove ball bearings and cylindrical roller bearings in particular, the noise level is sometimes specified depending on their purpose. For high-precision miniature ball bearings, the starting torque can be specified. Deep groove ball bearings are recommended for applications in which low noise and torque are required, such as in motors or instruments.

2.8 Running Accuracy and Bearing Types

For the main spindles of machine tools that require high running accuracy or high-speed applications like superchargers, high-precision bearings of Accuracy Class 5, 4 or 2 are usually used. The running accuracy of rolling bearings is specified in various ways, and specified accuracy classes vary depending on the bearing type. A comparison of the inner ring radial runout for the highest running accuracy specified for each bearing type is shown in Fig. 2.7.

Deep groove ball bearings, angular contact ball bearings, and cylindrical roller bearings are most suitable for applications requiring high running accuracy.

2.9 Mounting and Dismounting of Various Bearing Types

Separable bearings, such as cylindrical roller bearings, needle roller bearings, and tapered roller bearings are convenient for mounting and dismounting. These types of bearings are recommended for machines in which bearings are mounted and dismounted rather often for periodic inspection. In addition, self-aligning ball bearings and spherical roller bearings (small-sized) with tapered bores can be mounted and dismounted relatively easily using sleeves.

Bearing Types	Highest Accuracy Specified	Tolerance Comparison of Inner Ring Radial Runout				
		1	2	3	4	5
Deep Groove Ball Bearings	Class 2	1	2	3	4	5
Angular Contact Ball Bearings	Class 2	1	2	3	4	5
Cylindrical Roller Bearings	Class 2	1	2	3	4	5
Tapered Roller Bearings	Class 4	1	2	3	4	5
Spherical Roller Bearings	Normal	1	2	3	4	5

Fig. 2.7 Relative Inner Ring Radial Runout of Highest Accuracy Class for Various Bearing Types

3. SELECTION OF BEARING ARRANGEMENT

3.1 Fixed-End and Free-End Bearings A 026

3.2 Example Bearing Arrangements A 027

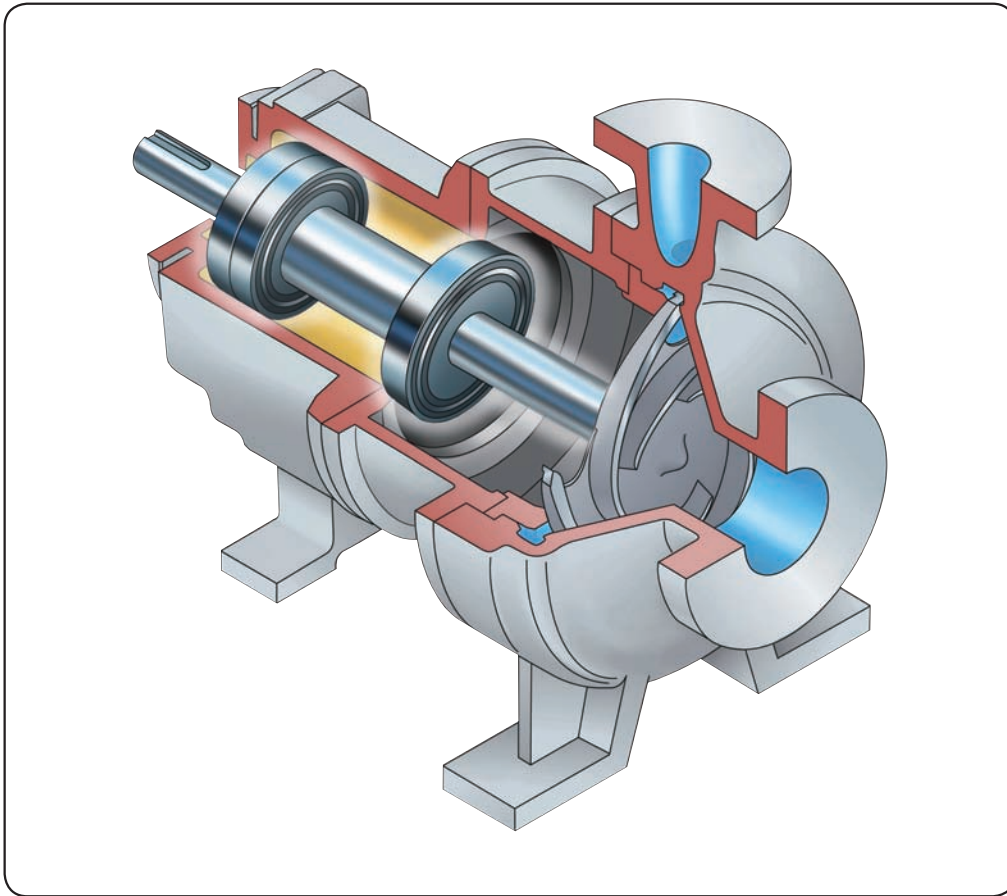

SELECTION OF BEARING ARRANGEMENT

3. SELECTION OF BEARING ARRANGEMENT

In general, shafts are supported by only two rolling bearings. When considering the bearing mounting arrangement, the following items must be investigated:

- (1) Expansion and contraction of the shaft caused by temperature variations
- (2) Ease of bearing mounting and dismounting
- (3) Misalignment of the inner and outer rings caused by deflection of the shaft or mounting error
- (4) Rigidity of the entire system, including bearings and preloading method
- (5) Capability to sustain loads at their proper positions and to transmit them

3.1 Fixed-End and Free-End Bearings

Usually only one "fixed-end" bearing on a shaft is used to fix the shaft axially. For this fixed-end bearing, a bearing type that can carry both radial and axial loads must be selected.

Other bearings must be "free-end" bearings that carry only radial loads to relieve the shaft's thermal elongation and contraction.

If measures to relieve a shaft's thermal elongation and contraction are insufficient, abnormal axial loads will be applied to the bearings, which can cause premature failure.

For free-end bearings, cylindrical roller bearings or needle roller bearings with separable inner and outer rings that are free to move axially (NU, N types, etc.) are recommended. Mounting and dismounting are also easier with these types.

When non-separable types are used as free-end bearings, usually the fit between the outer ring and housing is loose to allow axial movement of the running shaft together with the bearing. Sometimes, such elongation is relieved by a loose fit between the inner ring and shaft.

When the distance between the bearings is short and the influence of the shaft elongation and contraction is negligible, two opposed angular contact ball bearings or tapered roller bearings are used. The axial clearance (possible axial movement) after the mounting is adjusted using nuts or shims.

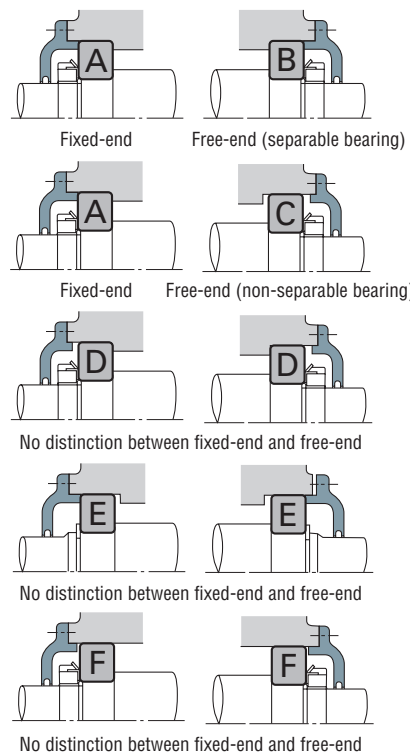

- BEARING A**
- Deep Groove Ball Bearing
 - Matched Angular Contact Ball Bearing
 - Double-Row Angular Contact Ball Bearing
 - Self-Aligning Ball Bearing
 - Cylindrical Roller Bearing with Ribs (NH, NUP types)
 - Double-Row Tapered Roller Bearing
 - Spherical Roller Bearing

- BEARING B**
- Cylindrical Roller Bearing (NU, N types)
 - Needle Roller Bearing (NA type, etc.)

- BEARING C⁽¹⁾**
- Deep Groove Ball Bearing
 - Matched Angular Contact Ball Bearing (back-to-back)
 - Double-Row Angular Contact Ball Bearing
 - Self-Aligning Ball Bearing
 - Double-Row Tapered Roller Bearing (KBE type)
 - Spherical Roller Bearing

- BEARING D, E⁽²⁾**
- Angular Contact Ball Bearing
 - Tapered Roller Bearing
 - Magneto Bearing
 - Cylindrical Roller Bearing (NJ, NF types)

- BEARING F**
- Deep Groove Ball Bearing
 - Self-Aligning Ball Bearing
 - Spherical Roller Bearing

Notes: ⁽¹⁾ In the figure, shaft elongation and contraction are relieved at the outside surface of the outer ring, but sometimes this is done at the bore.
⁽²⁾ For each type, two bearings are used in an opposed arrangement.

The distinction between free-end and fixed-end bearings and some possible bearing mounting arrangements for various bearing types are shown in Fig. 3.1.

3.2 Example Bearing Arrangements

Some representative bearing mounting arrangements considering preload and rigidity of the entire assembly, shaft elongation and contraction, mounting error, etc. are shown in Table 3.1.

Table 3.1 Representative Bearing Mounting Arrangements and Application Examples

Bearing Arrangements		Remarks	Application Examples
Fixed-end	Free-end		
		<ul style="list-style-type: none"> ○ This is a common arrangement in which abnormal loads are not applied to bearings even if the shaft expands or contracts. ○ If mounting error is small, this is suitable for high speeds. 	Medium-sized electric motors, blowers
		<ul style="list-style-type: none"> ○ This arrangement can withstand heavy loads and shock loads and can take some axial load. ○ All cylindrical roller bearings are separable. This is helpful when interference is necessary for both the inner and outer rings. 	Traction motors for rolling stock
		<ul style="list-style-type: none"> ○ This arrangement is used when loads are relatively heavy. ○ A back-to-back type is used for maximum rigidity as a fixed-end bearing. ○ Both the shaft and housing must have high accuracy and the mounting error must be small. 	Table rollers for steel mills, main spindles of lathes
		<ul style="list-style-type: none"> ○ This arrangement is suitable when interference is necessary for both the inner and outer rings. Heavy axial loads cannot be applied. 	Calender rolls of paper making machines, axles of diesel locomotives
		<ul style="list-style-type: none"> ○ This arrangement is suitable for high speeds and heavy radial loads. Moderate axial loads can also be applied. ○ Some clearance is necessary between the outer ring of the deep groove ball bearing and the housing bore in order to avoid subjecting it to radial loads. 	Reduction gears in diesel locomotives

Fig. 3.1 Bearing Mounting Arrangements and Bearing Types

Continued on next page

Table 3.1 Representative Bearing Mounting Arrangements and Application Examples (cont'd)

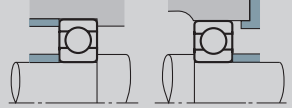
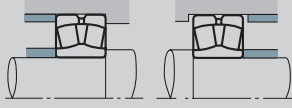
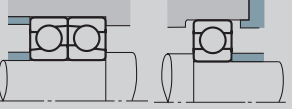
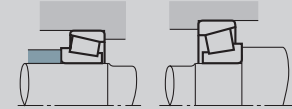
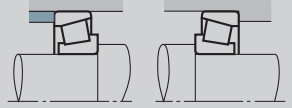
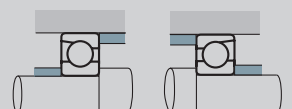
Bearing Arrangements		Remarks	Application Examples
Fixed-end	Free-end		
		<ul style="list-style-type: none"> This is the most common arrangement. It can sustain not only radial loads, but also moderate axial loads. 	Double-suction volute pumps, automotive transmissions
		<ul style="list-style-type: none"> This is the most suitable arrangement when there is mounting error or shaft deflection. It is often used for general and industrial applications in which heavy loads are applied. 	Speed reducers, table rollers of steel mills, wheels for overhead travelling cranes
		<ul style="list-style-type: none"> This is suitable when there are rather heavy axial loads in both directions. Double-row angular contact bearings may be used instead of an arrangement of two angular contact ball bearings. 	Worm gear reducers
When there is no distinction between fixed-end and free-end		Remarks	Application Examples
		<ul style="list-style-type: none"> This arrangement is widely used since it can withstand heavy loads and shock loads. The back-to-back arrangement is especially good when the distance between bearings is short and moment loads are applied. Face-to-face mounting makes mounting easier when interference is necessary for the inner ring. In general, this arrangement is good when there is mounting error. To use this arrangement with a preload, take extra care to ensure the correct amount of preload and clearance adjustment. 	Pinion shafts of automotive differential gears, automotive front and rear axles, worm gear reducers
			
		<ul style="list-style-type: none"> This arrangement is used at high speeds when radial loads are not so heavy and axial loads are relatively heavy. It provides good rigidity of the shaft by preloading. For moment loads, back-to-back mounting is better than face-to-face mounting. 	Grinding wheel shafts

Continued on next page

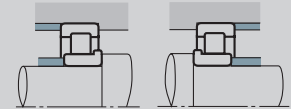
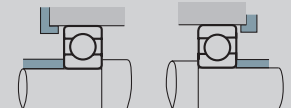
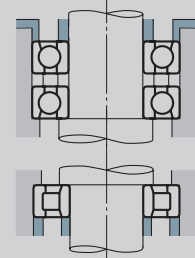
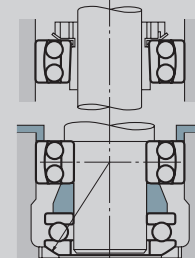
When there is no distinction between fixed-end and free-end		Remarks	Application Examples
			
		<ul style="list-style-type: none"> Sometimes a spring is used on the side of the outer ring of one bearing. 	Small electric motors, small speed reducers, small pumps
Vertical arrangements		Remarks	Application Examples
		<ul style="list-style-type: none"> Matched angular contact ball bearings are used on the fixed end. A cylindrical roller bearing is used on the free end. 	Vertical electric motors
		<ul style="list-style-type: none"> The spherical center of the self-aligning seat must coincide with that of the self-aligning ball bearing. The upper bearing is on the free end. 	Vertical openers (spinning and weaving machines)

4. SELECTION OF BEARING SIZE

4.1 Bearing Life	A 032	4.6 Example Bearing Calculations	A 054
4.1.1 Rolling Fatigue Life and Basic Rating Life	A 032	4.7 Bearing Type and Allowable Axial Load	A 058
4.2 Basic Load Rating and Fatigue Life	A 032	4.7.1 Change in Contact Angle of Radial Ball Bearings and Allowable Axial Load	A 058
4.2.1 Basic Load Rating	A 032	(1) Change in Contact Angle Due to Axial Load	A 058
4.2.2 Machinery in Which Bearings are Used and Projected Life	A 034	(2) Allowable Axial Load for a Deep Groove Ball Bearing	A 062
4.2.3 Selection of Bearing Size Based on Basic Load Rating	A 035	4.7.2 Allowable Axial Load (Rib Breakdown Strength) for Cylindrical Roller Bearings	A 064
4.2.4 Temperature Adjustment for Basic Load Rating	A 035	4.8 Technical Data	A 066
4.2.5 Correction of Basic Rating Life	A 037	4.8.1 Fatigue Life and Reliability	A 066
4.2.6 Life Calculation of Multiple Bearings as a Group	A 038	4.8.2 Radial Clearance and Fatigue Life	A 068
4.2.7 New Life Theory	A 040	4.8.3 Misalignment of Inner/Outer Rings and Fatigue Life of Deep Groove Ball Bearings	A 070
4.3 Calculation of Bearing Loads	A 044	4.8.4 Misalignment of Inner/Outer Rings and Fatigue Life of Cylindrical Roller Bearings	A 072
4.3.1 Load Factor	A 044	4.8.5 Oil Film Parameters and Rolling Fatigue Life	A 074
4.3.2 Bearing Loads in Belt or Chain Transmission Applications	A 044	4.8.6 EHL Oil Film Parameter Calculation Diagram	A 076
4.3.3 Bearing Loads in Gear Transmission Applications	A 045	(1) Oil Film Parameter	A 076
4.3.4 Load Distribution on Bearings	A 045	(2) Oil Film Parameter Calculation Diagram	A 076
4.3.5 Average Fluctuating Load	A 046	(3) Effect of Oil Shortage and Shearing Heat Generation	A 080
4.3.6 Combination of Rotating and Stationary Loads	A 048	4.8.7 Load Calculation for Gears	A 082
4.4 Equivalent Load	A 050	(1) Calculation of Loads on Spur, Helical, and Double-Helical Gears	A 082
4.4.1 Calculation of Equivalent Loads	A 050	(2) Calculation of Load on Straight Bevel Gears	A 086
4.4.2 Axial Load Components in Angular Contact Ball Bearings and Tapered Roller Bearings	A 051	(3) Calculation of Load on Spiral Bevel Gears	A 088
4.5 Static Load Ratings and Static Equivalent Loads	A 052	(4) Calculation of Load on Hypoid Gears	A 090
4.5.1 Static Load Ratings	A 052	(5) Calculation of Load on Worm Gears	A 094
4.5.2 Static Equivalent Loads	A 052		
4.5.3 Permissible Static Load Factor	A 052		

4. SELECTION OF BEARING SIZE

4.1 Bearing Life

The various functions required of rolling bearings vary according to the bearing application and must be performed for a prolonged period. Even if bearings are properly mounted and correctly operated, they will eventually fail to perform satisfactorily due to an increase in noise and vibration, loss of running accuracy, deterioration of grease, or fatigue flaking of the rolling surfaces.

Bearing life, in a broad sense of the term, is the period during which bearings continue to operate and satisfy their required functions. This bearing life may be defined as noise life, abrasion life, grease life, or rolling fatigue life, depending on which causes loss of bearing service.

Aside from the failure of bearings to function due to natural deterioration, bearings may fail when conditions such as heat-seizure, fracture, scoring of the rings, damage to the seals or cage, or other damage occurs.

Conditions such as these should not be interpreted as normal bearing failure since they often occur as a result of errors in bearing selection, improper design or manufacture of the bearing surroundings, incorrect mounting, or insufficient maintenance.

4.1.1 Rolling Fatigue Life and Basic Rating Life

When rolling bearings are operated under load, the raceways of their inner and outer rings and rolling elements are subjected to repeated cyclic stress. Because of metal fatigue of the rolling contact surfaces of the raceways and rolling elements, scaly particles may separate from the bearing material (Fig. 4.1). This phenomenon is called "flaking". Rolling fatigue life is represented by the total number of revolutions at which the bearing surface will start flaking due to stress. This is called fatigue life. As shown in Fig. 4.2, even for seemingly identical bearings of the same type, size, and material that receive the same heat treatment and other processing, the rolling fatigue life varies greatly, even under identical operating conditions. This is because the flaking of materials due to fatigue is subject to many other variables. Consequently, "basic rating life", in which rolling fatigue life is treated as a statistical phenomenon, is used in preference to actual rolling fatigue life.

Suppose a number of bearings of the same type are operated individually under the same conditions. After a certain period of time, 10 % of them fail as a result of flaking caused by rolling fatigue. The total number of revolutions at this point is defined as the basic rating life or, if the speed is constant, the basic rating life is often expressed by the total number of operating hours completed when 10 % of the bearings become inoperable due to flaking.

In determining bearing life, basic rating life is often the only factor considered; however, other factors must also be taken into account. For example, the grease

life of grease-lubricated bearings (refer to Section 11, Lubrication, Page A228) can be estimated. Since noise life and abrasion life are judged according to individual standards for different applications, specific values for noise or abrasion life must be determined empirically.

4.2 Basic Load Rating and Fatigue Life

4.2.1 Basic Load Rating

The basic load rating is defined as the constant load applied on bearings with stationary outer rings that the inner rings can endure for a rating life of one million revolutions (10^6 rev). The basic load rating of radial bearings is defined as a central radial load of constant direction and magnitude, while the basic load rating of thrust bearings is defined as an axial load of constant magnitude in the same direction as the central axis. The load ratings are listed under C_r for radial bearings and C_a for thrust bearings in the dimension tables.

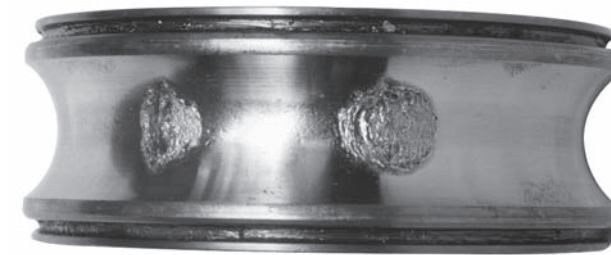

Fig. 4.1 Flaking Example

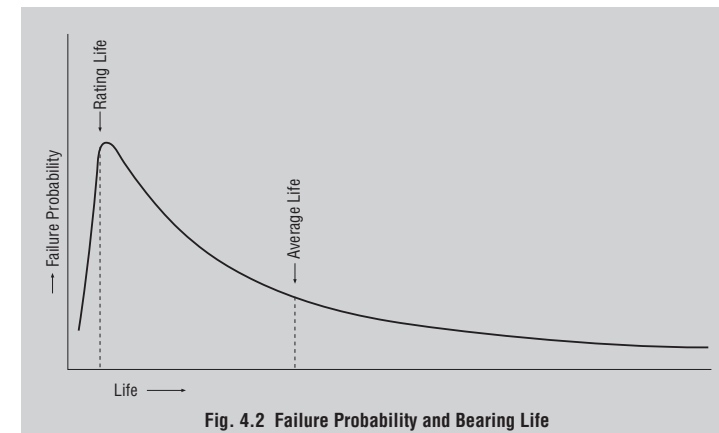

Fig. 4.2 Failure Probability and Bearing Life

SELECTION OF BEARING SIZE

4.2.2 Machinery in Which Bearings are Used and Projected Life

Selecting bearings with unnecessarily high load ratings is not advised, as such bearings may be too large and uneconomical. In addition, the bearing life alone should not be the deciding factor in the selection of bearings. The strength, rigidity, and design of the shaft

on which the bearings will be mounted should also be considered. Bearings are used in a wide range of applications and the design life varies with specific applications and operating conditions. Table 4.1 gives empirical fatigue life factors derived from typical operating experience for various machines. Formulae for various life parameters can be found in Table 4.2.

Table 4.1 Fatigue Life Factor f_h for Various Bearing Applications

Operating Period	Fatigue Life Factor f_h				
	~3	2~4	3~5	4~7	6~
Infrequently used or only for short periods	• Small motors for home appliances, such as vacuum cleaners and washing machines • Power tools	• Agricultural equipment			
Used only occasionally but reliability is important		• Motors for home heaters and air conditioners • Construction equipment	• Conveyors • Elevator cable sheaves		
Used intermittently for relatively long periods	• Rolling mill roll necks	• Small motors • Deck cranes • General cargo cranes • Pinion stands • Passenger cars	• Factory motors • Machine tools • Transmissions • Vibrating screens • Crushers	• Crane sheaves • Compressors • Specialized transmissions	
Used intermittently for more than eight hours daily		• Escalators	• Centrifugal separators • Air conditioning equipment • Blowers • Woodworking machines • Large motors • Axle boxes on railway rolling stock	• Mine hoists • Press flywheels • Railway traction motors • Locomotive axle boxes	• Paper making machines
Used continuously and high reliability is important					• Waterworks pumps • Electric power stations • Mine draining pumps

Table 4.2 Basic Rating Life, Fatigue Life Factor, and Speed Factor

Life Parameter	Ball Bearings	Roller Bearings
Basic Rating Life	$L_h = \frac{10^6}{60n} \left(\frac{C}{P}\right)^3 = 500f_h^3$	$L_h = \frac{10^6}{60n} \left(\frac{C}{P}\right)^{\frac{10}{3}} = 500f_h^{\frac{10}{3}}$
Fatigue Life Factor	$f_h = f_n \frac{C}{P}$	$f_h = f_n \frac{C}{P}$
Speed Factor	$f_n = \left(\frac{10^6}{500 \cdot 60n}\right)^{\frac{1}{3}} = (0.03n)^{-\frac{1}{3}}$	$f_n = \left(\frac{10^6}{500 \cdot 60n}\right)^{\frac{3}{10}} = (0.03n)^{-\frac{3}{10}}$

n, f_nFig. 4.3 (See Page A036), Appendix Table 12 (See Page E018)
 L_h, f_hFig. 4.4 (See Page A036), Appendix Table 13 (See Page E019)

4.2.3 Selection of Bearing Size Based on Basic Load Rating

The following relation exists between bearing load and basic rating life:

For ball bearings $L = \left(\frac{C}{P}\right)^3$ (4.1)

For roller bearings $L = \left(\frac{C}{P}\right)^{\frac{10}{3}}$ (4.2)

where L : Basic rating life (10^6 rev)
 P : Bearing load (equivalent load) (N), {kgf}
(Refer to Page A30)
 C : Basic load rating (N), {kgf}
 For radial bearings, C is written C_r
 For thrust bearings, C is written C_a

It is convenient to express the fatigue life in terms of hours for bearings that run at a constant speed. In general, the fatigue life of bearings used in automobiles and other vehicles is given in terms of mileage.

By designating the basic rating life as L_h (h), bearing speed as n (min^{-1}), fatigue life factor as f_h , and speed factor as f_n , the relations shown in Table 4.2 are obtained.

If the bearing load P and speed n are known, it's possible to determine a fatigue life factor f_h appropriate for the desired life of the machine and then calculate the minimum basic load rating C with the following Equation:

$C = \frac{f_h \cdot P}{f_n}$ (4.3)

A bearing that satisfies this value of C should then be selected from the bearing tables.

4.2.4 Temperature Adjustment for Basic Load Rating

If rolling bearings are used at high temperatures, the hardness of the bearing steel decreases. Consequently, the basic load rating, which depends on the physical properties of the material, also decreases; therefore, the basic load rating should be adjusted for higher temperatures through the following equation:

$C_t = f_t \cdot C$ (4.4)

where C_t : Basic load rating after temperature correction (N), {kgf}

f_t : Temperature factor (See Table 4.3.)

C : Basic load rating before temperature adjustment (N), {kgf}

If bearings are used above 120 °C, they must be given a special dimensional stability heat treatment to prevent excessive dimensional changes. The basic load rating of bearings after such special dimensional stability heat treatment may become lower than the basic load rating listed in the bearing tables.

Table 4.3 Temperature Factor f_t

Bearing Temperature °C	125	150	175	200	250
Temperature Factor f_t	1.00	1.00	0.95	0.90	0.75

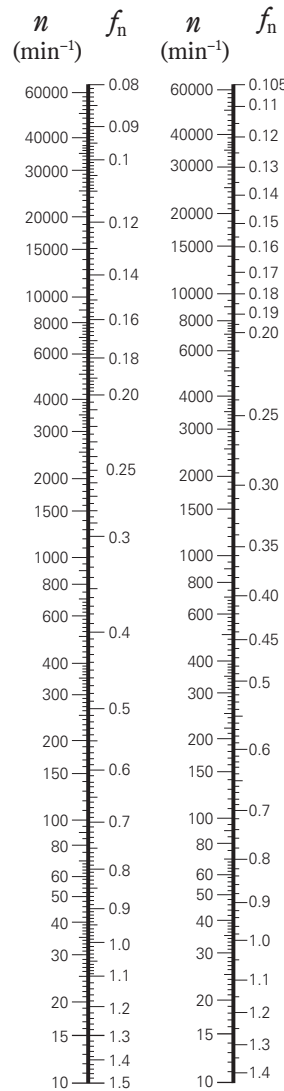

Ball Bearings Roller Bearings

Fig. 4.3 Bearing Speed and Speed Factor

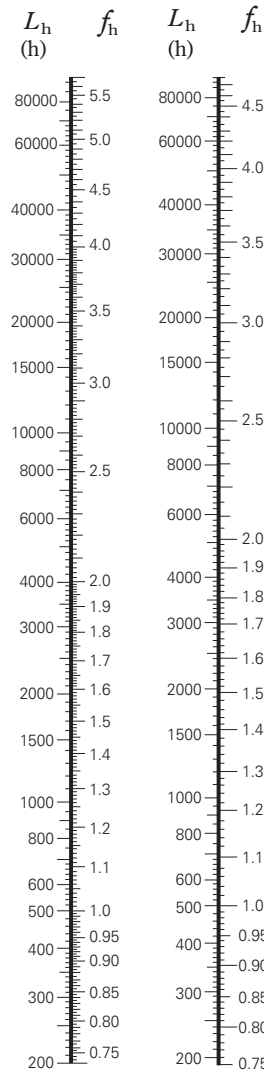

Ball Bearings Roller Bearings

Fig. 4.4 Fatigue Life Factor and Fatigue Life

4.2.5 Correction of Basic Rating Life

As described previously, the basic equations for calculating basic rating life are as follows:

For ball bearings $L_{10} = \left(\frac{C}{P}\right)^3$ (4.5)

For roller bearings $L_{10} = \left(\frac{C}{P}\right)^{\frac{10}{3}}$ (4.6)

L_{10} life is defined as the basic rating life with a statistical reliability of 90%. Depending on the machines in which the bearings are used, sometimes a reliability higher than 90% may be required. However, recent improvements in bearing material have greatly extended fatigue life. In addition, the development of the Elasto-Hydrodynamic Theory of Lubrication proves that the thickness of the lubricating film in the contact zone between rings and rolling elements greatly influences bearing life. To reflect such improvements in the calculation of fatigue life, the basic rating life is adjusted using the following adjustment factors:

$L_{na} = a_1 a_2 a_3 L_{10}$ (4.7)

where L_{na} : Adjusted rating life in which reliability, material improvements, lubricating conditions, etc. are considered

L_{10} : Basic rating life with a reliability of 90%

a_1 : Life adjustment factor for reliability

a_2 : Life adjustment factor for special bearing properties

a_3 : Life adjustment factor for operating conditions

The life adjustment factor for reliability a_1 , is listed in Table 4.4 for reliabilities higher than 90%.

The life adjustment factor for special bearing properties a_2 is used to reflect improvements in bearing steel.

NSK now uses vacuum-degassed bearing steel, and test results show that life is greatly improved compared with earlier materials. The basic load ratings C_r and C_a listed in the bearing tables were calculated considering the extended life achieved by improvements in materials and manufacturing techniques. Consequently, when estimating life using Equation (4.7), you may assume that a_2 is greater than one.

Table 4.4 Reliability Factor a_1

Reliability (%)	90	95	96	97	98	99
a_1	1.00	0.64	0.55	0.47	0.37	0.25

The life adjustment factor for operating conditions a_3 is used to adjust for various factors, particularly lubrication. If there is no misalignment between the inner and outer rings and the thickness of the lubricating film in the contact zones of the bearing is sufficient, it is possible for a_3 to be greater than one; however, a_3 is less than one in the following cases:

- When the viscosity of the lubricant in the contact zones between the raceways and rolling elements is low.
- When the circumferential speed of the rolling elements is very slow.
- When bearing temperature is high.
- When lubricant is contaminated by water or foreign matter.
- When misalignment of the inner and outer rings is excessive.

It is difficult to determine the proper value of a_3 for specific operating conditions because there are still many unknowns. Since the special bearing property factor a_2 is also influenced by the operating conditions, there is a proposal to combine a_2 and a_3 into one quantity ($a_2 \cdot a_3$), and not consider them independently. In this case, under normal lubricating and operating conditions, the product ($a_2 \cdot a_3$) should be assumed equal to one. However, if the viscosity of the lubricant is too low, the value drops to as low as 0.2.

If there is no misalignment and a lubricant with high viscosity is used so that a sufficient fluid-film thickness is secured, the product of ($a_2 \cdot a_3$) may be about two.

When selecting a bearing based on the basic load rating, it is best to choose an a_1 reliability factor appropriate for the projected use and an empirically determined C/P or f_h value derived from past results for lubrication, temperature, mounting conditions, etc. in similar machines.

The basic rating life Equations (4.1), (4.2), (4.5), and (4.6) give satisfactory results for a broad range of bearing loads. However, extra-heavy loads may cause detrimental plastic deformation at ball/raceway contact points. When P_r exceeds C_{or} (basic static load rating) or $0.5 C_r$, whichever is smaller, for radial bearings or P_a exceeds $0.5 C_a$ for thrust bearings, please consult NSK to establish the applicability of the rating fatigue life equations.

SELECTION OF BEARING SIZE

4.2.6 Life Calculation of Multiple Bearings as a Group

When multiple rolling bearings are used in one machine, the fatigue life of individual bearings can be determined if the load acting on individual bearings is known. However, a machine generally becomes inoperative if a bearing in any part fails. It may therefore be necessary in certain cases to know the fatigue life of a group of bearings used in one machine. The fatigue life of the bearings varies greatly and our fatigue life calculation equation

$L = \left(\frac{C}{P}\right)^p$ applies to the 90% life (also called the rating

fatigue life, which is either the gross number of revolutions or hours that 90% of multiple similar bearings operated under similar conditions can reach). In other words, the calculated fatigue life for one bearing has a probability of 90%. Since the endurance probability of a group of multiple bearings for a certain period is a product of the endurance probability of individual bearings for the same period, the rating fatigue life of a group of multiple bearings is not determined solely from the shortest rating fatigue life among the individual bearings. In fact, the group life is much shorter than the life of the bearing with the shortest fatigue life.

Assuming the rating fatigue life of individual bearings as $L_1, L_2, L_3 \dots$ and the rating fatigue life of the entire group of bearings as L , the equation below is obtained:

$$\frac{1}{L^e} = \frac{1}{L_1^e} + \frac{1}{L_2^e} + \frac{1}{L_3^e} + \dots \quad (4.8)$$

where $e=1.1$ (both for ball and roller bearings)

L of Equation (4.8) can be determined easily by using Fig. 4.5.

To use this chart, find the L_1 value from Equation (4.8) on the L_1 scale and the value of L_2 on the L_2 scale, connect them with a straight line, and read where the line intersects the L scale. In this way, the value of L_A in

$$\frac{1}{L_A^e} = \frac{1}{L_1^e} + \frac{1}{L_2^e}$$

can be determined. Take this value L_A on the L_1 scale and the L_3 value on the L_2 scale, connect them with a straight line, and read where the line intersects the L scale. In this way, the value L in

$$\frac{1}{L^e} = \frac{1}{L_1^e} + \frac{1}{L_2^e} + \frac{1}{L_3^e}$$

can be determined.

Example

Assume that the calculated fatigue life values of automotive front wheel bearings are as follows:

280 000 km for inner bearing

320 000 km for outer bearing

Then, the fatigue life of the wheel bearings can be determined as 160 000 km from Fig. 4.5.

If the fatigue life of the bearing of the right-hand wheel bearing takes this value, the fatigue life of the left-hand wheel bearing will be the same. As a result, the fatigue life of the front wheels as a group is 85 000 km.

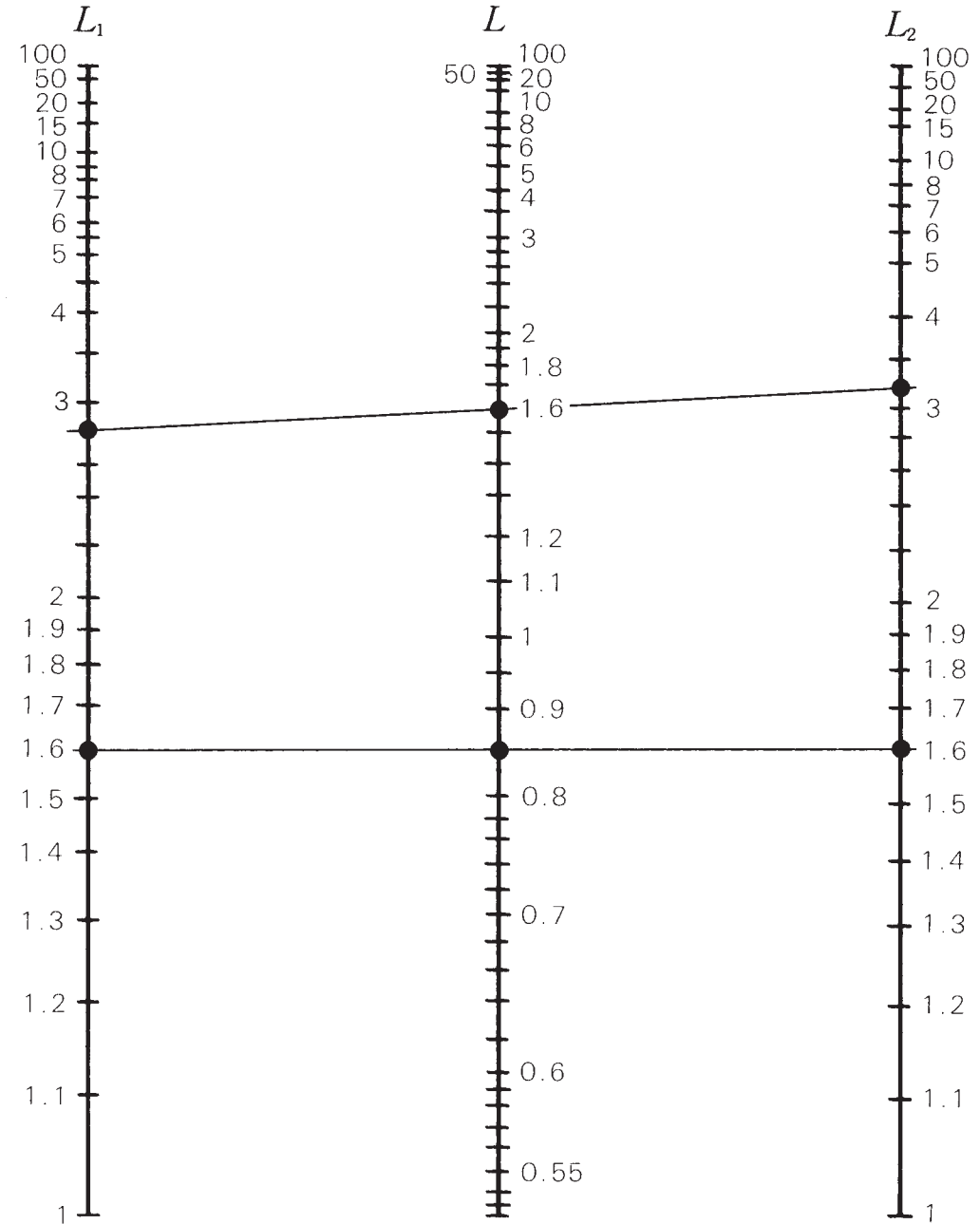

Fig. 4.5 Life Calculation Chart

SELECTION OF BEARING SIZE

4.2.7 New Life Theory

Bearing technology has advanced rapidly in recent years, particularly in the areas of dimensional accuracy and material cleanliness. As a result, bearings in a clean environment can now have a longer rolling fatigue life than the life obtained by the traditional ISO life calculation formula. This extended life is partly due to the important advancements in bearing-related technology, such as lubrication, cleanliness, and filtration.

The conventional life calculation formula (Equation 4.9) based on the theories of G. Lundberg and A. Palmgren (L-P theory, hereafter) addresses only subsurface-originated flaking. In this phenomenon, cracks initially occur due to dynamic shear stress immediately below the rolling surface and progressively reach the surface in the form of flaking.

$$\ln \frac{1}{S} \propto N^e \frac{\tau_o^c \cdot N^e \cdot V}{Z_o^h} \dots\dots\dots (4.9)$$

NSK's new life calculation formula theorizes that rolling fatigue life is the sum total of the combined effects of both subsurface-originated flaking and surface-originated flaking occurring simultaneously.

NSK New Life Calculation Formula

(1) Subsurface-originated flaking

A precondition of subsurface-originated flaking in rolling bearings is contact of the rolling elements with the raceway via a sufficient and continuous oil film under clean lubrication conditions.

Fig. 4.6 plots the L_{10} life for each test condition with maximum surface contact pressure (P_{max}) and the number of repeated stresses cycles.

In the figure, line L_{10} theoretical refers to the theoretical line obtained using the conventional life calculation formula. As maximum surface contact pressure decreases, the line representing actual life separates from the conventionally calculated theoretical line towards longer life. This separation suggests the presence of a fatigue load limit P_u below which no rolling fatigue occurs. The difference between NSK's revised theory (Equation 4.10) and the conventional theory is better illustrated in Fig. 4.7.

$$\ln \frac{1}{S} \propto N^e \int_V \frac{(\tau - \tau_u)^c}{Z_o^h} dV \dots\dots\dots (4.10)$$

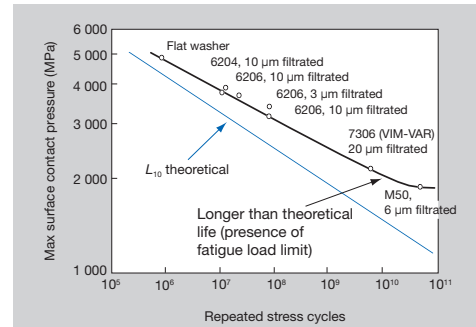

Fig. 4.6 Life Test Results Under Clean Lubrication

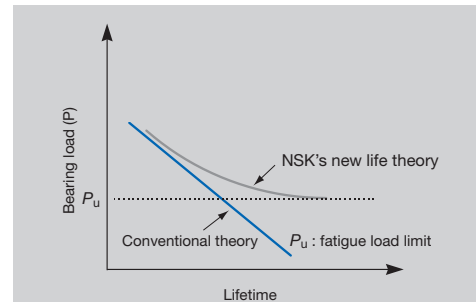

Fig. 4.7 NSK's New Life Theory That Considers Fatigue Limit

(2) Surface-originated flaking

Under actual bearing operation, the lubricant is often contaminated with foreign objects such as metal chips, burrs, cast sand, etc.

When foreign particles are mixed in the lubricant, they become pressed onto the raceways by the rolling elements and dents occur on the surfaces of the raceways and rolling elements. Stress concentrations occur at the edges of the dents, generating fine cracks that over time propagate into flaking of the raceways and rolling elements.

As shown in Fig. 4.8, actual life is shorter than conventional calculated life under contaminated lubrication conditions at low maximum surface pressure. This result shows that the actual life under contaminated lubrication is further shortened compared to the theoretical life because of the decrease in maximum surface contact pressure.

Table 4.5 Values of Contamination Coefficient a_c

	Very Clean	Clean	Normal	Contaminated	Heavily Contaminated
a_c Factor	1	0.8	0.5	0.4-0.1	0.05
Application Guide	10 μ m filtration	10-30 μ m filtration	30-100 μ m filtration	Greater than 100 μ m filtration or no filtration (oil bath, circulating lubrication, etc.)	No filtration, presence of many fine particles
Application Examples	Sealed grease-lubricated bearings for electrical appliances, information technology equipment, etc.	Sealed grease-lubricated bearings for electric motors, railway axle boxes, machine tools, etc.	Normal usage, automotive hub unit bearings, etc.	Bearings for automotive transmissions, industrial gearboxes, construction machines, etc.	—

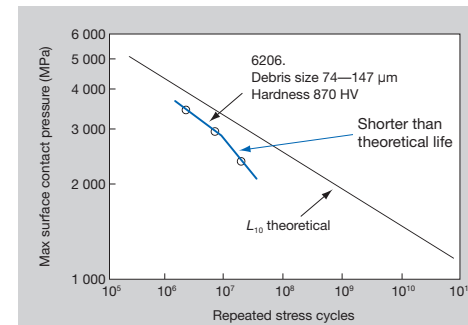

Fig. 4.8 Life Test Results Under Contaminated Lubrication Conditions

Therefore, the new NSK life calculation formula considers the trend of results in life tests under clean conditions and low load. Based on these results, the new life equation is a function of $(P-P_u)/C$ affected by specific lubrication conditions identified by the lubrication parameter. In addition, the effects of different types and shapes of foreign particles are assumed to be strongly influenced by bearing load and lubrication conditions. Such a relationship can be expressed as a function of the load parameter. This relationship of the new life calculation formula is defined as $(P-P_u)/C \cdot 1/a_c$.

The Equation for calculating surface-originated flaking based on the above concept is as follows:

$$\ln \frac{1}{S} \propto N^e \int_V \frac{(\tau - \tau_u)^c}{Z_o^h} dV \times \left\{ \frac{1}{f(a_c, a_l)} - 1 \right\} \dots\dots (4.11)$$

(3) Calculation of Contamination Coefficient a_c

The contamination coefficient in Table 4.5 is determined in terms of lubrication cleanliness. Test results on ball and roller bearings with grease and filtered lubrication show life as a number of times longer than the conventional calculation would suggest. Yet, hardness becomes a factor when foreign particles harder than Hv350 enter the bearing, causing dents on the raceway. Fatigue damage from these dents can progress to flaking in a short time. Test results on ball and roller bearings under foreign particle contamination show from 1/3 to 1/10 the conventionally calculated life.

Based on these test results, the contamination coefficient a_c for NSK's new life theory is classified into five levels.

SELECTION OF BEARING SIZE

(4) *New life calculation formula* L_{able}

The following formula, which combines subsurface-originated flaking and surface-originated flaking, is proposed as the new life calculation formula:

$$\ln \frac{1}{S} \propto N^e \int_V \frac{(\tau - \tau_u)^c}{Z_o^h} dV \times \left\{ \frac{1}{f(a_c, a_L)} \right\} \dots \dots (4.12)$$

$$L_{able} = a_1 \cdot a_{NSK} \cdot L_{10} \dots \dots \dots (4.13)$$

Life Correction Factor a_{NSK}

The life correction factor a_{NSK} is the function of lubrication parameter $(P - P_u)/C \cdot 1/a_c$, as shown below:

$$a_{NSK} \propto F \left\{ \frac{P - P_u}{C} \cdot \frac{1}{a_c}, a_L \right\} \dots \dots \dots (4.14)$$

NSK's new life theory considers the life-extending effect of improved material and heat treatment by correcting contamination factor a_c . The theory also utilizes viscosity ratio K ($K = \nu/\nu_1$ where ν is the operational viscosity and ν_1 the required viscosity) because the lubrication parameter a_L changes with the degree of oil film formation based on the lubricant and operating temperature. The theory indicates that the better the lubrication conditions (higher K), the longer the life.

Figures 4.9 and 4.10 show the diagrams of correction factor a_{NSK} as a function of the new life calculation formula. In addition, point contact and line contact are considered separately for ball and roller bearings respectively in this new formula.

List of symbols used:

- S : Probability that flaking does not occur after stress has been repeated N times
- N : Number of repeated stresses
- τ : Internal stress
- τ_u : Internal stress at fatigue limit
- V : Stress volume
- Z0 : Depth at which maximum shear stress occurs
- a_c : Contamination coefficient
- a_L : Lubrication parameter
(a function of viscosity ratio K)
- P : Load applied to bearing
- P_u : Fatigue load limit
- C : Basic dynamic load rating
- e, c, h : Constants

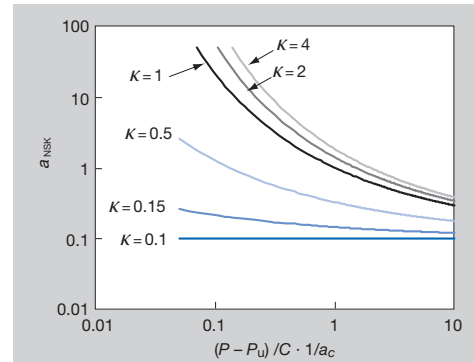

Fig. 4.9 New Life Calculation Diagram for Ball Bearings

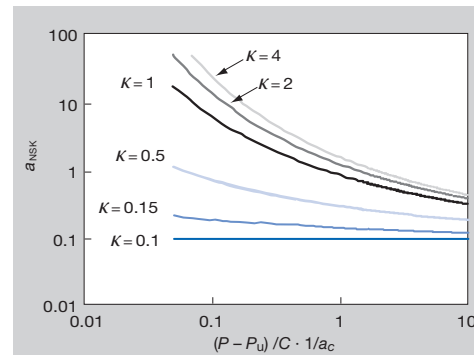

Fig. 4.10 New Life Calculation Diagram for Roller Bearings

Table 4.5 Reliability Factor a_1 Used in New Life Calculation Formula L_{able}

Reliability (%)	90	95	96	97	98	99
a_1	1.00	0.62	0.53	0.44	0.33	0.21

To Access NSK Calculation Tools

Visit our website at <http://www.nsk.com>

SELECTION OF BEARING SIZE

4.3 Calculation of Bearing Loads

The loads applied on bearings generally include the weight of the body to be supported by the bearings, the weight of the rotating elements themselves, the transmission power of gears and belting, the load produced by operation of the machine in which the bearings are used, and so on. These loads can be theoretically calculated, but some of them are difficult to estimate. Therefore, be sure to correct estimates using empirically derived data.

4.3.1 Load Factor

When a radial or axial load has been mathematically calculated, the actual load on the bearing may be greater than the calculated load because of vibration and shock present during machine operation. The actual load may be calculated using the following equation:

$$\left. \begin{aligned} F_r &= f_w \cdot F_{rc} \\ F_a &= f_w \cdot F_{ac} \end{aligned} \right\} \dots\dots\dots (4.15)$$

where F_r, F_a : Loads applied on bearing (N), {kgf}

F_{rc}, F_{ac} : Theoretically calculated load (N), {kgf}

f_w : Load factor

The values given in Table 4.6 are usually used for the load factor f_w .

4.3.2 Bearing Loads in Belt or Chain Transmission Applications

The force acting on the pulley or sprocket wheel when power is transmitted with a belt or chain is calculated using the following equations:

$$\left. \begin{aligned} M &= 9\,550\,000H / n \dots (N \cdot \text{mm}) \\ &= 974\,000H / n \dots \{ \text{kgf} \cdot \text{mm} \} \end{aligned} \right\} \dots\dots\dots (4.16)$$

$$P_k = M / r \dots\dots\dots (4.17)$$

where M : Torque acting on pulley or sprocket wheel (N·mm), {kgf·mm}

P_k : Effective force transmitted by belt or chain (N), {kgf}

H : Power transmitted (kW)

n : Speed (min⁻¹)

r : Effective radius of pulley or sprocket wheel (mm)

When calculating the load on a pulley shaft, belt tension must be included. Thus, to calculate actual load K_b for belt transmissions, the effective transmitting power is multiplied by the belt factor f_b , which represents belt tension. The values of the belt factor f_b for different types of belts are shown in Table 4.7.

$$K_b = f_b \cdot P_k \dots\dots\dots (4.18)$$

For chain transmissions, values corresponding to f_b should be 1.25 to 1.5.

4.3.3 Bearing Loads in Gear Transmission Applications

The loads imposed on gears in gear transmissions vary according to the type of gears used. In the simplest case of spur gears, the load is calculated as follows:

$$\left. \begin{aligned} M &= 9\,550\,000H / n \dots (N \cdot \text{mm}) \\ &= 974\,000H / n \dots \{ \text{kgf} \cdot \text{mm} \} \end{aligned} \right\} \dots\dots\dots (4.19)$$

$$P_k = M / r \dots\dots\dots (4.20)$$

$$S_k = P_k \tan \theta \dots\dots\dots (4.21)$$

$$K_c = \sqrt{P_k^2 + S_k^2} = P_k \sec \theta \dots\dots\dots (4.22)$$

where M : Torque applied to gear (N·mm), {kgf·mm}

P_k : Tangential force on gear (N), {kgf}

S_k : Radial force on gear (N), {kgf}

K_c : Combined force imposed on gear (N), {kgf}

H : Power transmitted (kW)

n : Speed (min⁻¹)

r : Pitch circle radius of drive gear (mm)

θ : Pressure angle

In addition to the theoretical load calculated above, vibration and shock, which depend on how accurately the gear is finished, should be included by multiplying the theoretically calculated load by gear factor f_g . The values of f_g should generally fall within the ranges in Table 4.8. When vibration from other sources occurs, the actual load is obtained by multiplying the load factor by this gear factor.

4.3.4 Load Distribution on Bearings

In the simple examples shown in Figs. 4.11 and 4.12, the radial loads on bearings I and II can be calculated using the following equations:

$$F_{CI} = \frac{b}{c} K \dots\dots\dots (4.23)$$

$$F_{CII} = \frac{a}{c} K \dots\dots\dots (4.24)$$

where F_{CI} : Radial load applied on bearing I (N), {kgf}

F_{CII} : Radial load applied on bearing II (N), {kgf}

K : Shaft load (N), {kgf}

When these loads are applied simultaneously, first the radial load for each should be obtained, then the sum of the vectors may be calculated according to the load direction.

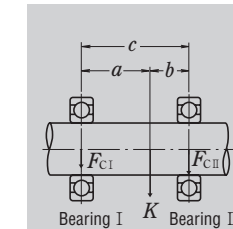

Fig. 4.11 Radial Load Distribution (1)

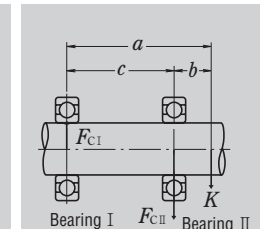

Fig. 4.12 Radial Load Distribution (2)

Table 4.6 Values of Load Factor f_w

Operating Conditions	Typical Applications	f_w
Smooth operation free from shocks	Electric motors, Machine tools, Air conditioners	1 to 1.2
Normal operation	Air blowers, Compressors, Elevators, Cranes, Paper making machines	1.2 to 1.5
Operation accompanied by shock and vibration	Construction equipment, Crushers, Vibrating screens, Rolling mills	1.5 to 3

Table 4.7 Belt Factor f_b

Type of Belt	f_b
Toothed belts	1.3 to 2
V belts	2 to 2.5
Flat belts with tension pulley	2.5 to 3
Flat belts	4 to 5

Table 4.8 Values of Gear Factor f_g

Gear Finish Accuracy	f_g
Precision ground gears	1 ~ 1.1
Ordinary machined gears	1.1 ~ 1.3

SELECTION OF BEARING SIZE

4.3.5 Average Fluctuating Load

When the load applied on bearings fluctuates, an average load that will yield the same bearing life as the fluctuating load should be calculated.

(1) When the relation between load and rotating speed is divided into the following steps (Fig. 4.13),

- Load F_1 : Speed n_1 ; Operating time t_1
- Load F_2 : Speed n_2 ; Operating time t_2
- ⋮
- Load F_n : Speed n_n ; Operating time t_n

the average load F_m may be calculated using the following equation:

$$F_m = \sqrt[p]{\frac{F_1^p n_1 t_1 + F_2^p n_2 t_2 + \dots + F_n^p n_n t_n}{n_1 t_1 + n_2 t_2 + \dots + n_n t_n}} \quad (4.25)$$

where F_m : Average fluctuating load (N), {kgf}

$p = 3$ for ball bearings

$p = 10/3$ for roller bearings

The average speed n_m may be calculated as follows:

$$n_m = \frac{n_1 t_1 + n_2 t_2 + \dots + n_n t_n}{t_1 + t_2 + \dots + t_n} \quad (4.26)$$

(2) When the load fluctuates almost linearly (Fig. 4.14), the average load may be calculated as follows:

$$F_m \doteq \frac{1}{3} (F_{\min} + 2F_{\max}) \quad (4.27)$$

where F_{\min} : Minimum fluctuating load value (N), {kgf}

F_{\max} : Maximum fluctuating load value (N), {kgf}

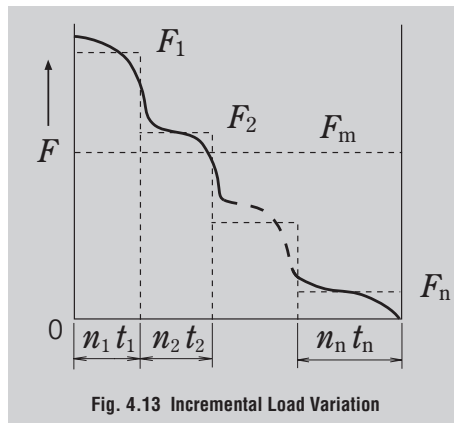

(3) When the load fluctuation is similar to a sine wave (Fig. 4.15), an approximate value for the average load F_m may be calculated from the following equation:

In the case of Fig. 4.15 (a)

$$F_m \doteq 0.65 F_{\max} \quad (4.28)$$

In the case of Fig. 4.15 (b)

$$F_m \doteq 0.75 F_{\max} \quad (4.29)$$

(4) When both a rotating load and a stationary load are applied (Fig. 4.16),

F_R : Rotating load (N), {kgf}

F_S : Stationary load (N), {kgf}

an approximate value for the average load F_m may be calculated as follows:

a) Where $F_R \geq F_S$

$$F_m \doteq F_R + 0.3F_S + 0.2 \frac{F_S^2}{F_R} \quad (4.30)$$

b) Where $F_R < F_S$

$$F_m \doteq F_S + 0.3F_R + 0.2 \frac{F_R^2}{F_S} \quad (4.31)$$

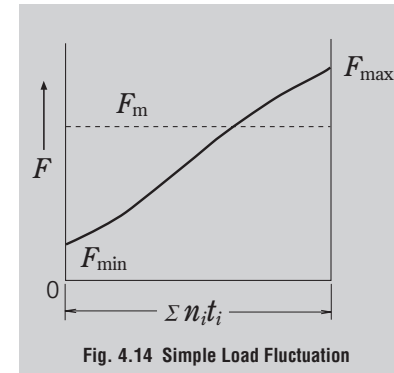

Fig. 4.14 Simple Load Fluctuation

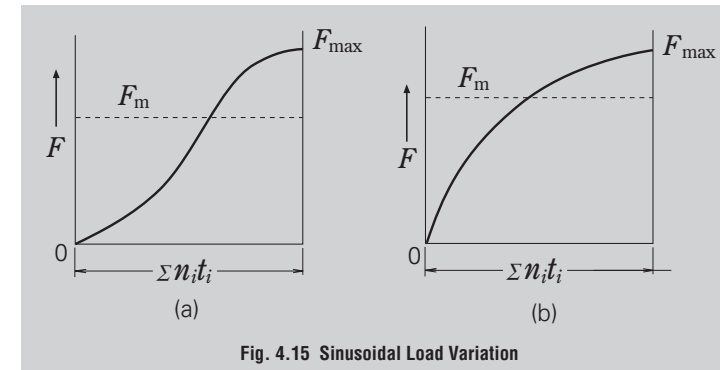

Fig. 4.15 Sinusoidal Load Variation

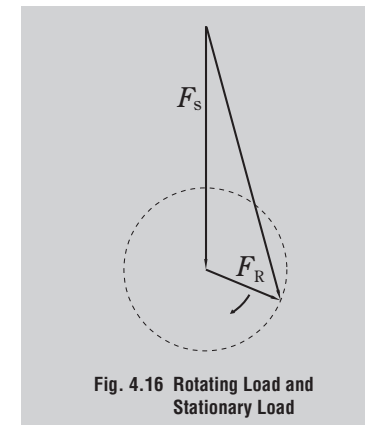

Fig. 4.16 Rotating Load and Stationary Load

4.3.6 Combination of Rotating and Stationary Loads

Generally, rotating, static, and indeterminate loads act on a rolling bearing. In certain cases, both the rotating load, which is caused by weight from unbalance or vibration, and the stationary load, which is caused by gravity or power transmission, may act simultaneously. The combined mean effective load can be calculated when indeterminate load is caused by rotating and static loads. There are two kinds of combined loads: rotating and stationary, which are classified depending on the magnitude of the load, as shown in Fig. 4.17.

Namely, the combined load becomes a running load with magnitude changing as shown in Fig. 4.17 (a) if the rotating load is larger than the static load. The combined load becomes an oscillating load with a magnitude changing as shown in Fig. 4.17 (b) if the rotating load is smaller than the stationary load.

In either case, the combined load F is expressed by the following equation:

$$F = \sqrt{F_R^2 + F_S^2} - 2F_R F_S \cos \theta \quad (4.32)$$

where F_R : Rotating load (N), {kgf}
 F_S : Stationary load (N), {kgf}
 θ : Angle defined by rotating and stationary loads

Combined load F can be approximated by Equations (4.33) and (4.34) which vary sinusoidally depending on the magnitude of F_R and F_S . $F_R + F_S$ becomes the maximum load F_{max} and $F_R - F_S$ becomes the minimum load F_{min} for $F_R \gg F_S$ or $F_R \ll F_S$.

$$F_R \gg F_S, F = F_R - F_S \cos \theta \quad (4.33)$$

$$F_R \ll F_S, F = F_S - F_R \cos \theta \quad (4.34)$$

Combined load F can also be approximated by Equations (4.35) and (4.36) when $F_R \approx F_S$.

$$F_R > F_S, F = F_R - F_S + 2F_S \sin \frac{\theta}{2} \quad (4.35)$$

$F_R < F_S,$

$$F = F_S - F_R + 2F_R \sin \frac{\theta}{2} \quad (4.36)$$

Curves of Equations (4.32), (4.33), (4.35), and (4.36) are shown in Fig. 4.18.

The mean load variation F_m as expressed by Equations (4.33) and (4.34) or (4.35) and (4.36) can be expressed respectively by Equations (4.37) and (4.38) or (4.39) and (4.40).

$$F_m = F_{min} + 0.65 (F_{max} - F_{min})$$

$$F_R \geq F_S, F_m = F_R + 0.3F_S \quad (4.37)$$

$$F_R \leq F_S, F_m = F_S + 0.3F_R \quad (4.38)$$

$$F_m = F_{min} + 0.75 (F_{max} - F_{min})$$

$$F_R \geq F_S, F_m = F_R + 0.5F_S \quad (4.39)$$

$$F_R \leq F_S, F_m = F_S + 0.5F_R \quad (4.40)$$

Generally, as the value F exists somewhere along Equations (4.37), (4.38), (4.39), and (4.40), the coefficient 0.3 or 0.5 of the second terms in these equations is assumed to change linearly along with F_S/F_R or F_R/F_S . Thus, these factors may be expressed as follows:

$$0.3 + 0.2 \frac{F_S}{F_R}, 0 \leq \frac{F_S}{F_R} \leq 1$$

or $0.3 + 0.2 \frac{F_R}{F_S}, 0 \leq \frac{F_R}{F_S} \leq 1$

Accordingly, F_m can be expressed by the following equation:

$$F_R \geq F_S,$$

$$F_m = F_R + (0.3 + 0.2 \frac{F_S}{F_R}) F_S$$

$$= F_R + 0.3F_S + 0.2 \frac{F_S^2}{F_R} \quad (4.41)$$

$$F_R \leq F_S,$$

$$F_m = F_S + (0.3 + 0.2 \frac{F_R}{F_S}) F_R$$

$$= F_S + 0.3F_R + 0.2 \frac{F_R^2}{F_S} \quad (4.42)$$

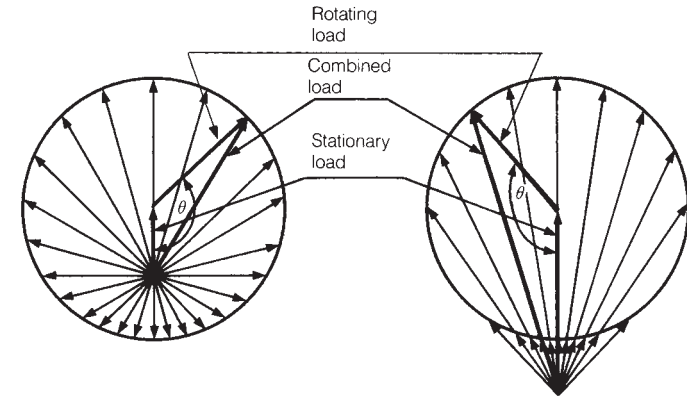

(a) Rotating load > stationary load (b) Rotating load < stationary load

Fig. 4.17 Combined Rotating and Stationary Loads

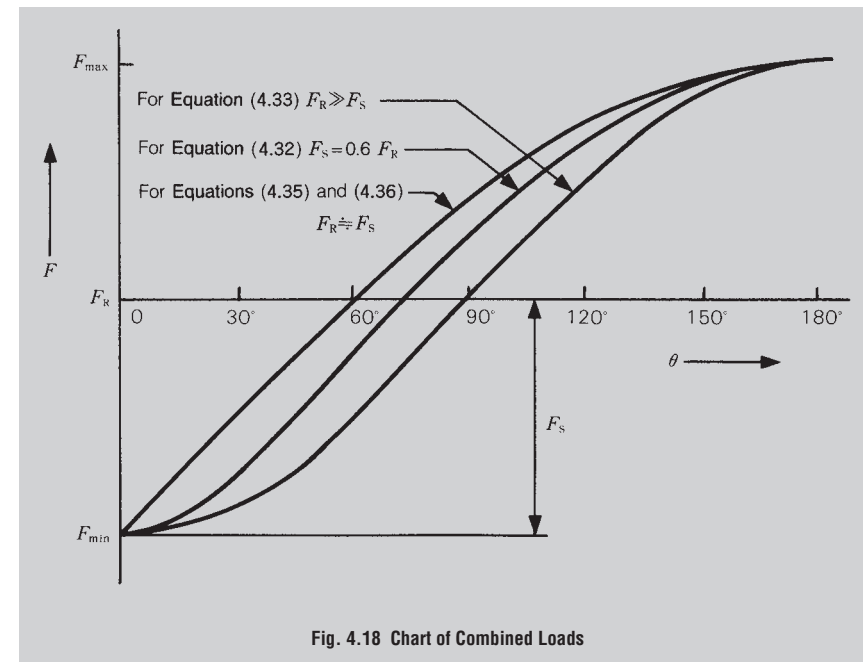

Fig. 4.18 Chart of Combined Loads

4.4 Equivalent Load

In some cases, the loads applied on bearings are purely radial or axial loads; however, in most cases, the loads are a combination of both. In addition, such loads usually fluctuate in both magnitude and direction. In such cases, the loads actually applied on bearings cannot be used for bearing life calculations; therefore, a hypothetical load should be estimated. This load should have a constant magnitude that passes through the center of the bearing and gives the same bearing life that the bearing would attain under actual load and rotation conditions. Such a hypothetical load is called the equivalent load.

4.4.1 Calculation of Equivalent Loads

The equivalent load on radial bearings may be calculated using the following equation:

$$P = XF_r + YF_a \dots\dots\dots (4.43)$$

where P : Equivalent Load (N), {kgf}
 F_r : Radial load (N), {kgf}
 F_a : Axial load (N), {kgf}
 X : Radial load factor
 Y : Axial load factor

The values of X and Y are listed in the bearing tables. The equivalent radial load for radial roller bearings with $\alpha = 0^\circ$ is

$$P = F_r$$

In general, thrust ball bearings cannot take radial loads, but spherical thrust roller bearings can take some radial loads. In this case, the equivalent load may be calculated using the following equation:

$$P = F_a + 1.2F_r \dots\dots\dots (4.44)$$

where $\frac{F_r}{F_a} \leq 0.55$

4.4.2 Axial Load Components in Angular Contact Ball Bearings and Tapered Roller Bearings

The effective load center of both angular contact ball bearings and tapered roller bearings is at the point of intersection between the shaft center line and a line representing the load applied on the rolling element by the outer ring, as shown in Fig. 4.19. This effective load center for each bearing is listed in the bearing tables. When radial loads are applied to these types of bearings, a component load is produced in the axial direction. In order to balance this component load, bearings of the same type are used in pairs, placed face-to-face or back-to-back. These axial loads can be calculated using the following equation:

$$F_{ai} = \frac{0.6}{Y} F_r \dots\dots\dots (4.45)$$

where F_{ai} : Component load in the axial direction (N), {kgf}
 F_r : Radial load (N), {kgf}
 Y : Axial load factor

Assume that radial loads F_{rI} and F_{rII} are applied on bearings I and II (Fig. 4.20) respectively and an external axial load F_{ae} is applied as shown. If the axial load factors are Y_I and Y_{II} and the radial load factor is X , then the equivalent loads P_I and P_{II} may be calculated as follows:

where $F_{ae} + \frac{0.6}{Y_{II}} F_{rII} \geq \frac{0.6}{Y_I} F_{rI}$

$$\left. \begin{aligned} P_I &= XF_{rI} + Y_I \left(F_{ae} + \frac{0.6}{Y_{II}} F_{rII} \right) \\ P_{II} &= F_{rII} \end{aligned} \right\} \dots\dots\dots (4.46)$$

where $F_{ae} + \frac{0.6}{Y_{II}} F_{rII} < \frac{0.6}{Y_I} F_{rI}$

$$\left. \begin{aligned} P_I &= F_{rI} \\ P_{II} &= XF_{rII} + Y_{II} \left(\frac{0.6}{Y_I} F_{rI} - F_{ae} \right) \end{aligned} \right\} \dots\dots\dots (4.47)$$

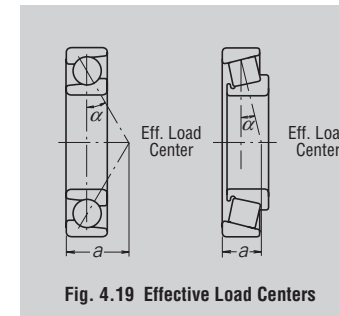

Fig. 4.19 Effective Load Centers

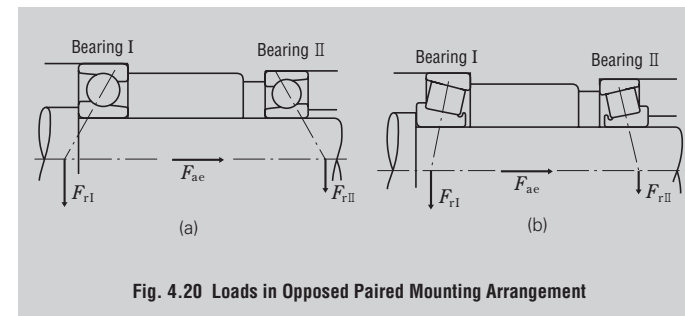

Fig. 4.20 Loads in Opposed Paired Mounting Arrangement

SELECTION OF BEARING SIZE

4.5 Static Load Ratings and Static Equivalent Loads

4.5.1 Static Load Ratings

When subjected to excessive or strong shock loads, rolling bearings may incur a local permanent deformation of the rolling elements and permanent deformation of the rolling elements and raceway surface if the elastic limit is exceeded. This nonelastic deformation increases in area and depth as load increases. When the load exceeds a certain limit, the smooth operation of the bearing is impeded.

The basic static load rating is defined as the static load that produces the following calculated contact stress between the raceway surface and center of the contact area of the rolling element subjected to the maximum stress:

For self-aligning ball bearings	4 600 MPa {469 kgf/mm ² }
For other ball bearings	4 200 MPa {428 kgf/mm ² }
For roller bearings	4 000 MPa {408 kgf/mm ² }

In this most heavily stressed contact area, the sum of the permanent deformation of the rolling element and that of the raceway is nearly 0.0001 times the rolling element diameter. The basic static load rating C_o is defined as C_{or} for radial bearings and C_{oa} for thrust bearings in the bearing tables.

In addition, following the modification of for basic static load rating criteria by ISO, the new C_o values for NSK's ball bearings became about 0.8 to 1.3 times the past values, while those for roller bearings became about 1.5 to 1.9 times higher. Consequently, please note that the previous values of permissible static load factor f_s have also changed.

4.5.2 Static Equivalent Loads

The static equivalent load is a hypothetical load that produces a contact stress equal to the above maximum stress in the area of contact between the most heavily stressed rolling element and bearing raceway under actual conditions while the bearing is stationary (including very slow rotation or oscillation). The static radial load passing through the bearing center is taken as the static equivalent load for radial bearings, while the static axial load in the direction coinciding with the central axis is taken as the static equivalent load for thrust bearings.

(a) *Static equivalent load on radial bearings*

The greater of the two values calculated from the following equations should be adopted as the static equivalent load on radial bearings:

$$P_o = X_o F_r + Y_o F_a \quad \dots \quad (4.47)$$

$$P_o = F_r \quad \dots \quad (4.48)$$

where P_o : Static equivalent load (N), {kgf}
 F_r : Radial load (N), {kgf}
 F_a : Axial load (N), {kgf}
 X_o : Static radial load factor
 Y_o : Static axial load factor

(b) *Static equivalent load on thrust bearings*

$$P_o = X_o F_r + F_a \quad \alpha \neq 90^\circ \quad \dots \quad (4.49)$$

where P_o : Static equivalent load (N), {kgf}
 α : Contact angle

When $F_a < X_o F_r$, this equation becomes less accurate. The values of X_o and Y_o for Equations (4.47) and (4.49) are listed in the bearing tables.

The static equivalent load for thrust roller bearings when

$$\alpha = 90^\circ \text{ is } P_o = F_a$$

4.5.3 Permissible Static Load Factor

The permissible static equivalent load on bearings varies depending on the basic static load rating, application, and operating conditions.

The permissible static load factor f_s is a safety factor that is applied to the basic static load rating, and it is defined by the ratio in Equation (4.50). The generally recommended values of f_s are listed in Table 4.9. The values of f_s were revised due to the modification of the basic static load rating criteria. Please keep this in mind when selecting bearings, particularly for bearings whose C_o values increased.

$$f_s = \frac{C_o}{P_o} \quad \dots \quad (4.50)$$

where C_o : Basic static load rating (N), {kgf}
 P_o : Static equivalent load (N), {kgf}

For spherical thrust roller bearings, the value of f_s should be greater than 4.

Table 4.9 Values of Permissible Static Load Factor f_s

Operating Conditions	Lower Limit of f_s	
	Ball Bearings	Roller Bearings
Low-noise applications	2	3
Bearings subjected to vibration and shock loads	1.5	2
Standard operating conditions	1	1.5

SELECTION OF BEARING SIZE
4.6 Example Bearing Calculations
(Example 1)

Obtain the fatigue life factor f_h of single-row deep groove ball bearing **6208** when it is used under a radial load $F_r=2\,500\text{ N}$ and speed $n=900\text{ min}^{-1}$.

The basic load rating C_r of **6208** is $29\,100\text{ N}$ (Bearing Table, Page C024). Since only a radial load is applied, the equivalent load P may be obtained as follows:

$$P = F_r = 2\,500\text{ N}$$

Since the speed is $n = 900\text{ min}^{-1}$, the speed factor f_n can be obtained from the equation in Table 4.2 (Page A034) or Fig. 4.3 (Page A036).

$$f_n = 0.333$$

The fatigue life factor f_h , under these conditions, can be calculated as follows:

$$f_h = f_n \frac{C_r}{P} = 0.333 \cdot \frac{29\,100}{2\,500} = 3.88$$

This value is suitable for industrial applications, air conditioners in regular use, etc., and according to the equation in Table 4.2 or Fig. 4.4 (Page A036), this corresponds to approximately 29 000 hours of service life.

(Example 2)

Select a single-row deep groove ball bearing with a bore diameter of 50 mm and outside diameter under 100 mm that satisfies the following conditions:

Radial load $F_r = 3\,000\text{ N}$

Speed $n = 1\,900\text{ min}^{-1}$

Basic rating life $L_h \geq 10\,000\text{ h}$

The fatigue life factor f_h of ball bearings with a rating fatigue life longer than 10 000 hours is $f_h \geq 2.72$. Because $f_n = 0.26$, $P = F_r = 3\,000\text{ N}$,

$$f_h = f_n \frac{C_r}{P} = 0.26 \cdot \frac{C_r}{3\,000} \geq 2.72$$

Therefore, $C_r \geq 2.72 \cdot \frac{3\,000}{0.26} = 31\,380\text{ N}$

From the data listed in the bearing table on Page C026, **6210** should be selected, as it satisfies the above conditions.

(Example 3)

Obtain C_r/P or fatigue life factor f_h when an axial load $F_a=1\,000\text{ N}$ is added to the conditions of (Example 1)

When the radial load F_r and axial load F_a are applied on single-row deep groove ball bearing **6208**, the dynamic equivalent load P should be calculated in accordance with the following procedure:

Obtain the radial load factor X , axial load factor Y , and constant e , depending on the magnitude of $f_0 F_a / C_{or}$, from the Dynamic Equivalent Load Table above the Bearing Table on Page C025.

The basic static load rating C_{or} of ball bearing **6208** is $17\,900\text{ N}$ (Page C024)

$$f_0 F_a / C_{or} = 14.0 \cdot 1\,000 / 17\,900 = 0.782$$

$$e \approx 0.26$$

and $F_a / F_r = 1\,000 / 2\,500 = 0.4 > e$

$$X = 0.56$$

$$Y = 1.67 \text{ (the value of } Y \text{ is obtained by linear interpolation)}$$

Therefore, the dynamic equivalent load P is

$$\begin{aligned} P &= XF_r + YF_a \\ &= 0.56 \cdot 2\,500 + 1.67 \cdot 1\,000 \\ &= 3\,070\text{ N} \end{aligned}$$

$$\frac{C_r}{P} = \frac{29\,100}{3\,070} = 9.48$$

$$f_h = f_n \frac{C_r}{P} = 0.333 \cdot \frac{29\,100}{3\,070} = 3.16$$

This value of f_h corresponds approximately to 15 800 hours of service life for ball bearings.

(Example 4)

Select a Series 231 spherical roller bearing that satisfies the following conditions:

Radial load $F_r = 45\,000\text{ N}$

Axial load $F_a = 8\,000\text{ N}$

Speed $n = 500\text{ min}^{-1}$

Basic rating life $L_h \geq 30\,000\text{ h}$

The value of the fatigue life factor f_h which makes $L_h \geq 30\,000\text{ h}$ is greater than 3.45, according to Fig. 4.4 (Page A036).

The dynamic equivalent load P of spherical roller bearings is as follows:

when $F_a / F_r \leq e$

$$P = XF_r + YX_a = F_r + Y_3 F_a$$

when $F_a / F_r > e$

$$P = XF_r + YF_a = 0.67 F_r + Y_2 F_a$$

$$F_a / F_r = 8\,000 / 45\,000 = 0.18$$

We can see in the bearing table that the value of e is about 0.3 and that of Y_3 is about 2.2 for Series 231 bearings.

$$\begin{aligned} \text{Therefore, } P &= XF_r + YF_a = F_r + Y_3 F_a \\ &= 45\,000 + 2.2 \cdot 8\,000 \\ &= 62\,600\text{ N} \end{aligned}$$

From the fatigue life factor f_h , the basic load rating can be obtained as follows:

$$f_h = f_n \frac{C_r}{P} = 0.444 \cdot \frac{C_r}{62\,600} \geq 3.45$$

Consequently, $C_r \geq 490\,000\text{ N}$

The smallest Series 231 spherical roller bearing satisfying this value of C_r is **23126CE4** ($C_r = 505\,000\text{ N}$).

Once the bearing is determined, substitute the value of Y_3 in the equation and obtain the value of P .

$$\begin{aligned} P &= F_r + Y_3 F_a = 45\,000 + 2.4 \cdot 8\,000 \\ &= 64\,200\text{ N} \end{aligned}$$

$$\begin{aligned} L_h &= 500 \left(f_n \frac{C_r}{P} \right)^{\frac{10}{3}} \\ &= 500 \left(0.444 \cdot \frac{505\,000}{64\,200} \right)^{\frac{10}{3}} \\ &= 500 \cdot 3.49^{\frac{10}{3}} \approx 32\,000\text{ h} \end{aligned}$$

(Example 5)

Assume that tapered roller bearings **HR30305DJ** and **HR30206J** are used in a back-to-back arrangement as shown in Fig. 4.21, and the distance between the outer ring back faces is 50 mm.

Calculate the basic rating life of each bearing when radial load $F_r = 5\,500\text{ N}$ and axial load $F_{ae} = 2\,000\text{ N}$ are applied to **HR30305DJ** as shown in Fig. 4.21. The speed is 600 min^{-1} .

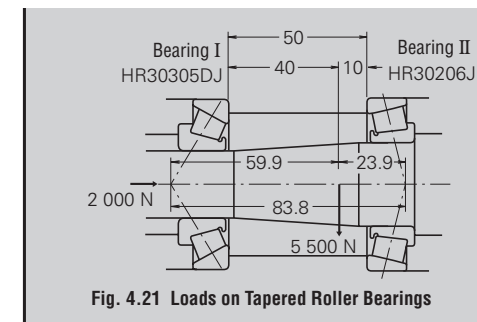

Fig. 4.21 Loads on Tapered Roller Bearings

To distribute the radial load F_r on bearings I and II, the effective load centers for tapered roller bearings must be located. Obtain the effective load center a for bearings I and II from the bearing table, then obtain the relative position of the radial load F_r and effective load centers. The result will be as shown in Fig. 4.21. Consequently, the radial load applied on bearings I (**HR30305DJ**) and II (**HR30206J**) can be obtained from the following equations:

$$F_{rI} = 5\,500 \cdot \frac{23.9}{83.8} = 1\,569\text{ N}$$

$$F_{rII} = 5\,500 \cdot \frac{59.9}{83.8} = 3\,931\text{ N}$$

The following values are obtained from data in the Bearing Table:

Bearings	Basic dynamic load rating C_r (N)	Axial load factor Y_1	Constant e
Bearing I (HR30305DJ)	38 000	$Y_I = 0.73$	0.83
Bearing II (HR30206J)	43 000	$Y_{II} = 1.6$	0.38

When radial loads are applied on tapered roller bearings, an axial load component is produced and must be considered to obtain the dynamic equivalent radial load (refer to Section 4.4.2, Page A051).

SELECTION OF BEARING SIZE

This is obtained by the following:

$$F_{ae} + \frac{0.6}{Y_{II}} F_{rII} = 2\,000 + \frac{0.6}{1.6} \cdot 3\,931 = 3\,474 \text{ N}$$

$$\frac{0.6}{Y_I} F_{rI} = \frac{0.6}{0.73} \cdot 1\,569 = 1\,290 \text{ N}$$

Therefore, with this bearing arrangement, the axial load $F_{ae} + \frac{0.6}{Y_{II}} F_{rII}$ is applied on bearing I but not on bearing II.

For bearing I,

$$F_{rI} = 1\,569 \text{ N}$$

$$F_{aI} = 3\,474 \text{ N}$$

since $F_{aI} / F_{rI} = 2.2 > e = 0.83$

$$\begin{aligned} \text{the dynamic equivalent load } P_I &= XF_{rI} + Y_I F_{aI} \\ &= 0.4 \cdot 1\,569 + 0.73 \cdot 3\,474 \\ &= 3\,164 \text{ N} \end{aligned}$$

The fatigue life factor $f_h = f_n \frac{C_r}{P_I}$

$$= \frac{0.42 \cdot 38\,000}{3\,164} = 5.04$$

$$\begin{aligned} \text{and the rating fatigue life } L_h &= 500 \cdot 5.04^{\frac{10}{3}} \\ &= 109\,750 \text{ h} \end{aligned}$$

For bearing II

since $F_{rII} = 3\,931 \text{ N}$, $F_{aII} = 0$

the dynamic equivalent load

$$P_{II} = F_{rII} = 3\,931 \text{ N},$$

fatigue life factor

$$f_h = f_n \frac{C_r}{P_{II}} = \frac{0.42 \cdot 43\,000}{3\,931} = 4.59$$

and rating fatigue life $L_h = 500 \cdot 4.59^{\frac{10}{3}} = 80\,400 \text{ h}$ are obtained.

For face-to-face arrangements (DF type), please contact NSK.

(Example 6)

Select a bearing for a speed reducer under the following conditions:

Operating conditions

Radial load $F_r = 245\,000 \text{ N}$

Axial load $F_a = 49\,000 \text{ N}$

Speed $n = 500 \text{ min}^{-1}$

Size limitation

Shaft diameter: 300 mm

Housing bore: Less than 500 mm

In this application, heavy loads, shocks, and shaft deflection are expected; therefore, spherical roller bearings are appropriate.

The following spherical roller bearings satisfy the above size limits (refer to Page C284):

d	D	B	Bearing No.	Basic Dynamic Load Rating C_r (N)	Constant e	Factor Y_3
300	420	90	23960 CAME4	1 540 000	0.19	3.5
	460	118	23060 CAME4	2 400 000	0.24	2.8
	460	160	24060 CAME4	2 890 000	0.32	2.1
	500	160	23160 CAME4	3 350 000	0.31	2.2
	500	200	24160 CAME4	3 900 000	0.38	1.8

Since $F_a / F_r = 0.20 < e$, the dynamic equivalent load P is

$$P = F_r + Y_3 F_a$$

Judging from the fatigue life factor f_h in Table 4.1 and example applications (refer to Page A034), a value of f_h , between 3 and 5 is appropriate.

$$f_h = f_n \frac{C_r}{P} = \frac{0.444 C_r}{F_r + Y_3 F_a} = 3 \text{ to } 5$$

Assuming that $Y_3 = 2.1$, then the necessary basic load rating C_r can be obtained:

$$\begin{aligned} C_r &= \frac{(F_r + Y_3 F_a) \cdot (3 \text{ to } 5)}{0.444} \\ &= \frac{(245\,000 + 2.1 \cdot 49\,000) \cdot (3 \text{ to } 5)}{0.444} \\ &= 2\,350\,000 \text{ to } 3\,900\,000 \text{ N} \end{aligned}$$

Bearings that satisfy this range are **23060CAME4**, **24060CAME4**, **23160CAME4**, and **24160CAME4**.

SELECTION OF BEARING SIZE

4.7 Bearing Type and Allowable Axial Load

4.7.1 Change in Contact Angle of Radial Ball Bearings and Allowable Axial Load

(1) Change in Contact Angle Due to Axial Load

When an axial load acts on a radial ball bearing, the rolling element and raceway develop elastic deformation, resulting in an increase in contact angle and width. When heat generation or seizure occurs, the bearing should be disassembled and checked for a running trace to discover whether there has been a change in contact angle during operation. In this way, it is possible to see whether an abnormal axial load has been sustained.

The relation below reflects axial load on a bearing F_a , the load on rolling element Q , and the contact angle α when a load is applied. (see Equations (9.8), (9.9), and (9.10) in Section 9.6.2)

$$F_a = Z Q \sin \alpha$$

$$= K Z D_w^2 \{ \sqrt{(\sin \alpha_0 + h)^2 + \cos^2 \alpha_0} - 1 \}^{3/2} \cdot \sin \alpha \quad (4.51)$$

$$\alpha = \sin^{-1} \frac{\sin \alpha_0 + h}{\sqrt{(\sin \alpha_0 + h)^2 + \cos^2 \alpha_0}} \quad (4.52)$$

$$h = \frac{\delta_a}{m_0} = \frac{\delta_a}{r_c + r_i - D_w}$$

Namely, δ_a refers to the change in Equation (4.52) to determine a contact angle α corresponding to the contact angle known from observation of the raceway. Thus, δ_a and α are introduced into Equation (4.51) to estimate the axial load F_a acting on the bearing. As specifications of the bearing are necessary for calculation, the contact angle α in this case was approximated from the axial load. The basic static load rating C_{0r} is expressed by Equation (4.53) for single-row radial ball bearings.

$$C_{0r} = f_0 Z D_w^2 \cos \alpha_0 \quad (4.53)$$

where f_0 : Factor determined from the shape of bearing components and applicable stress level

Equation (4.54) is determined from Equations (4.51) and (4.53):

$$\frac{f_0}{C_{0r}} F_a = A F_a$$

$$= K \{ \sqrt{(\sin \alpha_0 + h)^2 + \cos^2 \alpha_0} - 1 \}^{3/2} \cdot \frac{\sin \alpha}{\cos \alpha_0} \quad (4.54)$$

where K : Constant determined from material and design of bearing

In other words, h is assumed and contact angle α is determined from Equation (4.52). Then h and α are introduced into Equation (4.54) to determine $A F_a$. This relation is used to show the value of A for each bore number of angular contact ball bearings in Table 4.14. The relationship between $A F_a$ and α is shown in Fig. 4.22.

Example 1

Calculate the change in the contact angle when pure axial load $F_a = 35.0$ kN (50% of basic static load rating) is applied to angular contact ball bearing 7215C.

$A = 0.212$ as determined from Table 4.10 and $A F_a = 0.212 \times 35.0 = 7.42$ and $\alpha = 26^\circ$ according to Fig. 4.22. The initial contact angle of 15° has changed to 26° under axial load.

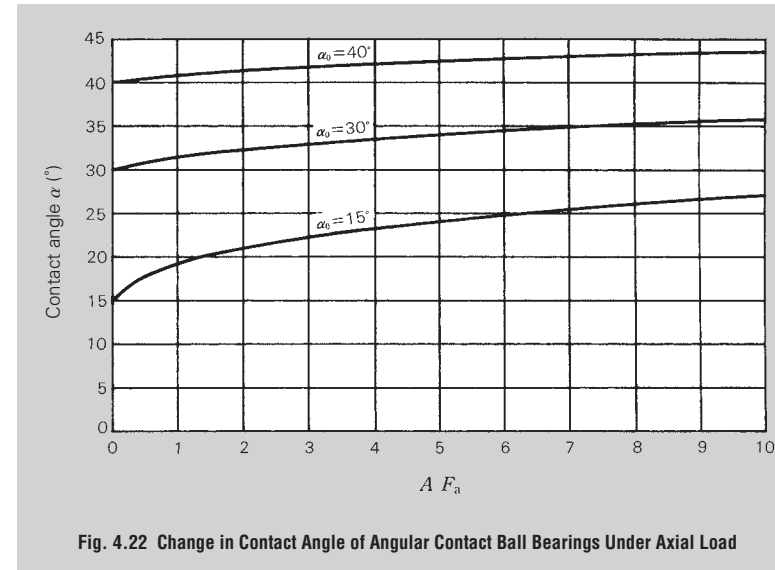

Fig. 4.22 Change in Contact Angle of Angular Contact Ball Bearings Under Axial Load

Table 4.10 Constant A Value of Angular Contact Ball Bearings

Units: kN^{-1}

Bearing Bore No.	Series 70 Bearings			Series 72 Bearings			Series 73 Bearings		
	15°	30°	40°	15°	30°	40°	15°	30°	40°
05	1.97	2.05	2.31	1.26	1.41	1.59	0.838	0.850	0.961
06	1.45	1.51	1.83	0.878	0.979	1.11	0.642	0.651	0.736
07	1.10	1.15	1.38	0.699	0.719	0.813	0.517	0.528	0.597
08	0.966	1.02	1.22	0.562	0.582	0.658	0.414	0.423	0.478
09	0.799	0.842	1.01	0.494	0.511	0.578	0.309	0.316	0.357
10	0.715	0.757	0.901	0.458	0.477	0.540	0.259	0.265	0.300
11	0.540	0.571	0.681	0.362	0.377	0.426	0.221	0.226	0.255
12	0.512	0.542	0.645	0.293	0.305	0.345	0.191	0.195	0.220
13	0.463	0.493	0.584	0.248	0.260	0.294	0.166	0.170	0.192
14	0.365	0.388	0.460	0.226	0.237	0.268	0.146	0.149	0.169
15	0.348	0.370	—	0.212	0.237	0.268	0.129	0.132	0.149
16	0.284	0.302	0.358	0.190	0.199	0.225	0.115	0.118	0.133
17	0.271	0.288	0.341	0.162	0.169	0.192	0.103	0.106	0.120
18	0.228	0.242	0.287	0.140	0.146	0.165	0.0934	0.0955	0.108
19	0.217	0.242	0.273	0.130	0.136	0.153	0.0847	0.0866	0.0979
20	0.207	0.231	0.261	0.115	0.119	0.134	0.0647	0.0722	0.0816

Values for deep groove ball bearings are similarly shown in Table 4.11 and Fig. 4.23.

Example 2

Calculate the change in the contact angle when a pure axial load $F_a = 24.75$ kN (50% of the basic static load rating) is applied to the deep groove ball bearing 6215. Note here that the radial internal clearance is calculated as the median (0.020 mm) of the normal clearance.

The initial contact angle of 10° is obtained from Fig. 3 on Page C015. $A = 0.303$ as determined from Table 4.11 and $A F_a = 0.303 \times 24.75 \approx 7.5$, thus $\alpha \approx 24^\circ$ based on Fig. 4.23.

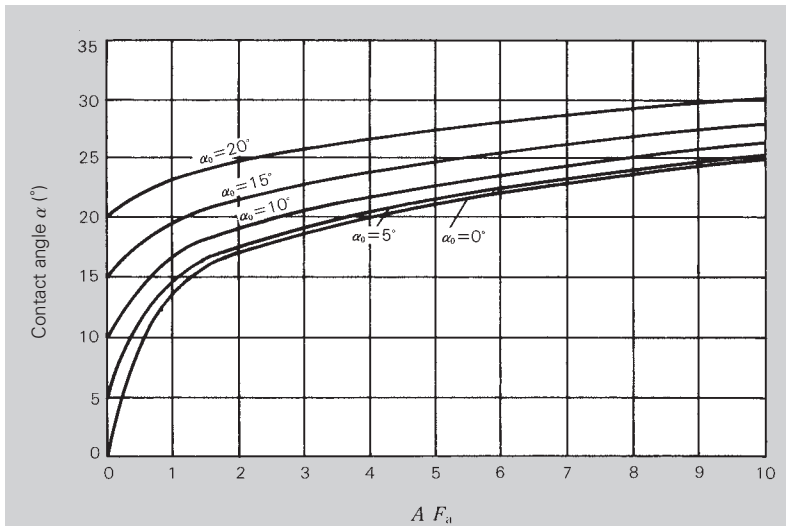

Fig. 4.23 Change in Contact Angle of Deep Groove Ball Bearings Under Axial Load

Table 4.11 Constant A Value of Deep Groove Ball Bearing

Units: kN^{-1}

Bearing Bore No.	Series 62 Bearings				
	0°	5°	10°	15°	20°
05	1.76	1.77	1.79	1.83	1.88
06	1.22	1.23	1.24	1.27	1.30
07	0.900	0.903	0.914	0.932	0.958
08	0.784	0.787	0.796	0.811	0.834
09	0.705	0.708	0.716	0.730	0.751
10	0.620	0.622	0.630	0.642	0.660
11	0.490	0.492	0.497	0.507	0.521
12	0.397	0.398	0.403	0.411	0.422
13	0.360	0.361	0.365	0.373	0.383
14	0.328	0.329	0.333	0.340	0.349
15	0.298	0.299	0.303	0.309	0.317
16	0.276	0.277	0.280	0.285	0.293
17	0.235	0.236	0.238	0.243	0.250
18	0.202	0.203	0.206	0.210	0.215
19	0.176	0.177	0.179	0.183	0.188
20	0.155	0.156	0.157	0.160	0.165

(2) Allowable Axial Load for a Deep Groove Ball Bearing

The allowable axial load here refers to the limit load at which a contact ellipse is generated between the ball and raceway due to a change in the contact angle when a radial bearing, which is under an axial load, rides over the shoulder of the raceway groove. This is different from the limit value of a static equivalent load P_0 which is determined from the basic static load rating C_{0r} using the static axial load factor Y_0 . Also note that the contact ellipse may ride over the shoulder even when the axial load on the bearing is below the limit value of P_0 .

The allowable axial load $F_{a \max}$ of a radial ball bearing can be determined through equations. The contact angle α for F_a is determined from the right terms of Equations (4.51) and Equation (4.52), while Q is calculated as follows:

$$Q = \frac{F_a}{Z \sin \alpha}$$

θ of Fig. 4.24 is determined as follows:

$$2a = A_2 \mu \left(\frac{Q}{\Sigma \rho} \right)^{1/3}$$

$$\therefore \theta \doteq \frac{a}{r}$$

Accordingly, the allowable axial load may be determined as the maximum axial load at which the following relation is established.

$$\gamma \geq \alpha + \theta$$

As the allowable axial load cannot be determined unless the internal specifications of a bearing are known, Fig. 4.25 shows the calculated results of allowable axial load for various deep groove radial ball bearings.

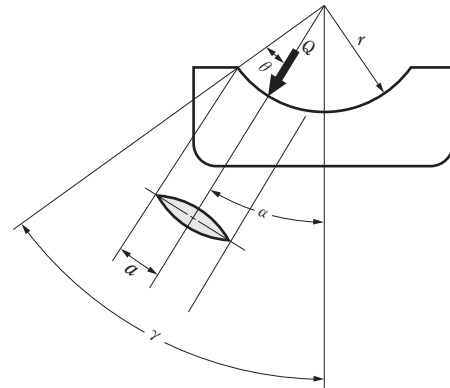

Fig. 4.24 Contact Ellipse

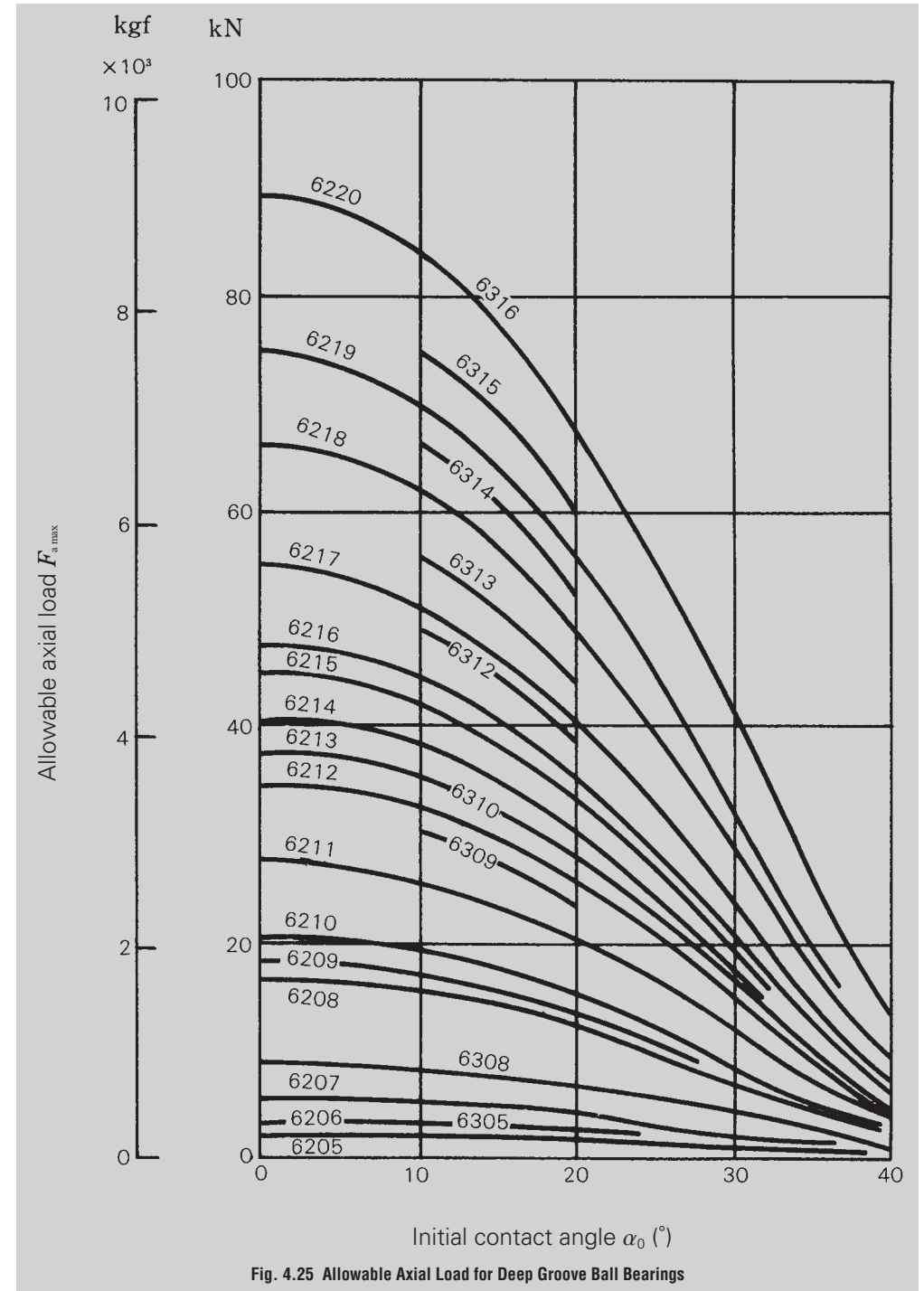

Fig. 4.25 Allowable Axial Load for Deep Groove Ball Bearings

4.7.2 Allowable Axial Load (Rib Breakdown Strength) for Cylindrical Roller Bearings

Both the inner and outer rings may be exposed to an axial load during rotation in a cylindrical roller bearing with ribs. The axial load capacity is limited by heat generation, seizure, etc. at the slip surface between the roller end surface and rib and rib strength.

Fig 4.26 shows the allowable axial load (the load considering heat generation between the end faces of the rollers and rib face) applied continuously on Diameter Series 3 cylindrical roller bearings with grease or oil lubrication.

Grease lubrication (Empirical equation)

$$C_A = 9.8f \left\{ \frac{900 (k \cdot d)^2}{n+1 500} - 0.023 \times (k \cdot d)^{2.5} \right\} \text{ (N)}$$

$$= f \left\{ \frac{900 (k \cdot d)^2}{n+1 500} - 0.023 \times (k \cdot d)^{2.5} \right\} \text{ {kgf}}$$

..... (4.55)

Oil lubrication (Empirical equation)

$$C_A = 9.8f \left\{ \frac{490 (k \cdot d)^2}{n+1 000} - 0.000135 \times (k \cdot d)^{3.4} \right\} \text{ (N)}$$

$$= f \left\{ \frac{490 (k \cdot d)^2}{n+1 000} - 0.000135 \times (k \cdot d)^{3.4} \right\} \text{ {kgf}}$$

..... (4.56)

where C_A : Allowable axial load (N), {kgf}
 d : Bearing bore diameter (mm)
 n : Bearing speed (min^{-1})
 f : Load factor
 k : Dimensional factor

In Equations (4.55) and (4.56), the examination of rib strength is excluded. Please consult with NSK concerning rib strength.

To enable the cylindrical roller bearing to stably sustain the axial load capacity, be sure to take the following points, concerning the bearing and its surroundings into account.

- Radial load must be applied and the magnitude of radial load should be larger than that of axial load by 2.5 times or more.
- There should be sufficient lubricant between the roller end face and rib.
- Use a lubricant with an additive for extreme pressures.
- Running-in time should be sufficient.
- Bearing mounting accuracy should be good.
- Don't use a bearing with an unnecessarily large internal clearance.

Moreover, if the bearing speed is very slow or exceeds 50 % of the allowable speed in the bearing tables or if the bearing bore diameter exceeds 200 mm, each bearing must be precisely checked for lubrication, cooling method, etc. Please contact NSK in such cases.

f : Load Factor

	f value
Continuous Loading	1
Intermittent Loading	2
Short-Term Loading	3

k : Dimensional Factor

	k value
Series 2 Bearing Diameter	0.75
Series 3 Bearing Diameter	1
Series 4 Bearing Diameter	1.2

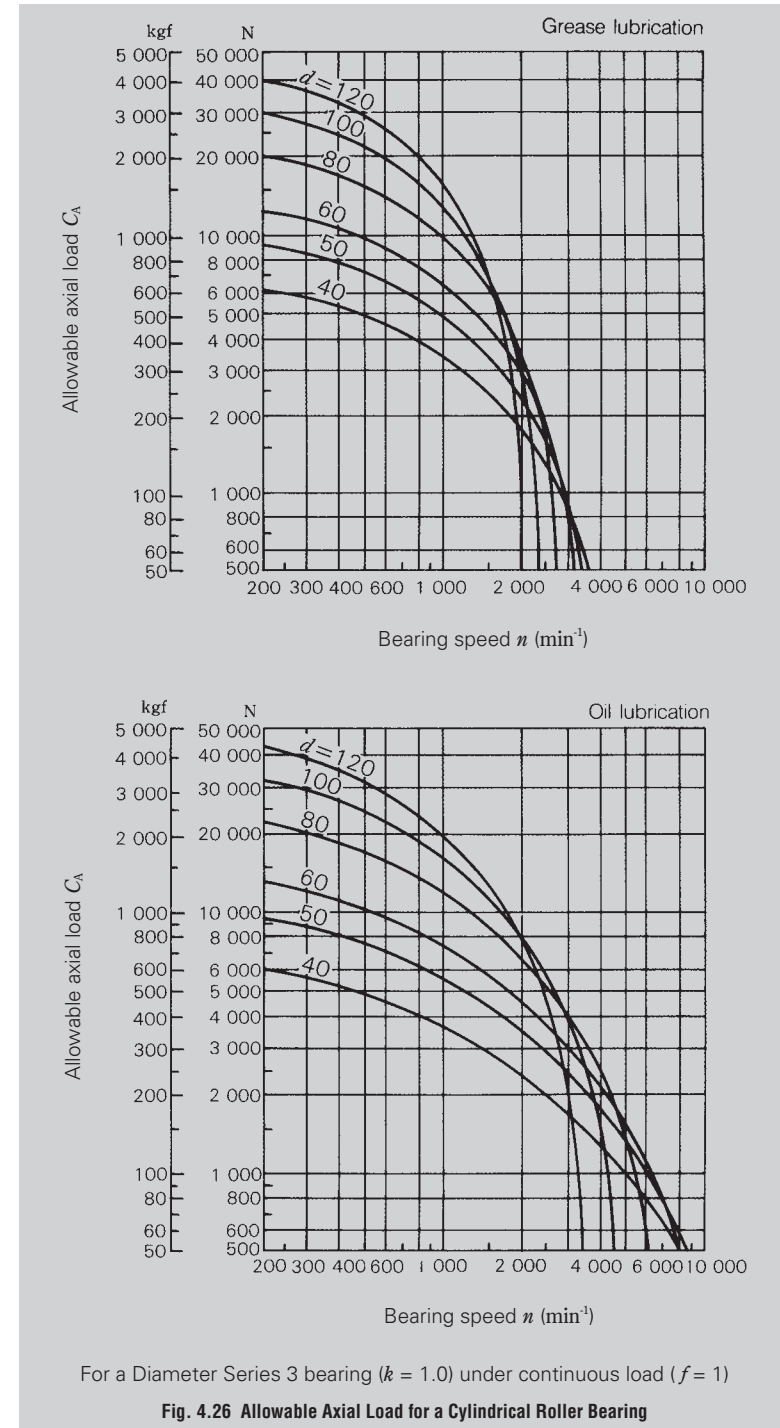

For a Diameter Series 3 bearing ($k = 1.0$) under continuous load ($f = 1$)

Fig. 4.26 Allowable Axial Load for a Cylindrical Roller Bearing

4.8 Technical Data

4.8.1 Fatigue Life and Reliability

Where any part failure may result in damage to the entire machine and repair of damage is impossible, as in aircraft, satellite, or rocket applications, greatly increased reliability is demanded of each component. Recently, such high reliability requirements have been applied more generally to durable consumer goods and may also be utilized to achieve effective preventive maintenance of machines and equipment.

The rating fatigue life of a rolling bearing is the gross number of revolutions or the gross rotating period (when the rotating speed is constant) that 90 % of a group of similar bearings running individually under similar conditions can rotate without suffering material damage due to rolling fatigue. In other words, fatigue life is normally defined at 90 % reliability. There are other ways to describe the expected life. For example, an average value is frequently employed to describe the lifespan of human beings. However, if an average were used for bearings, then too many bearings would fail before the average life value was reached. On the other hand, if a low or minimum value was used as a criterion, then too many bearings would have a life much longer than the set value. With these considerations in mind, a 90 % value was chosen for common practice. A value of 95 % could have been taken as the statistical reliability, but the slightly looser reliability of 90 % was taken from a practical and economical viewpoint. A 90 % reliability however is not acceptable for aircraft parts, computers, or communication systems, and a 99 % or even 99.9 % reliability may be required in some of these cases.

The fatigue life distribution when a group of similar bearings are operated individually under similar conditions is shown in Fig. 4.27. The Weibull equation can be used to describe the fatigue life distribution

within a damage ratio of 10 to 60 % (residual probability of 90 to 40 %). At a damage ratio of 10 % or less (residual probability of 90 % or more) however, the rolling fatigue life becomes longer than the theoretical curve of the Weibull distribution, as shown in Fig. 4.28. This is a conclusion drawn from the life test of numerous, widely-varying bearings and an analysis of collected data.

When bearing life with a failure ratio of 10 % or less (for example, the 95 % life or 98 % life) is to be considered on the basis of the above concept, the reliability factor α_1 , shown in Table 4.12 is used to check the life. Assume here that the 98 % life L_2 is to be calculated for a bearing whose rating fatigue life L_{10} was calculated at 10 000 hours. The life can be calculated as $L_2 = 0.37 \times L_{10} = 3\,700$ hours. In this manner, the reliability of the bearing life can be matched to the equipment and difficulty of inspection and disassembly.

Table 4.12 Reliability Factor

Reliability, %	90	95	96	97	98	99
Life, L	L_{10} rating life	L_5	L_4	L_3	L_2	L_1
Reliability Factor, α_1	1	0.64	0.55	0.47	0.37	0.25

Apart from rolling fatigue, factors such as lubrication, wear, sound, and accuracy govern the durability of a bearing. These factors must be taken into account, but the endurance limit of these factors varies depending on application and conditions.

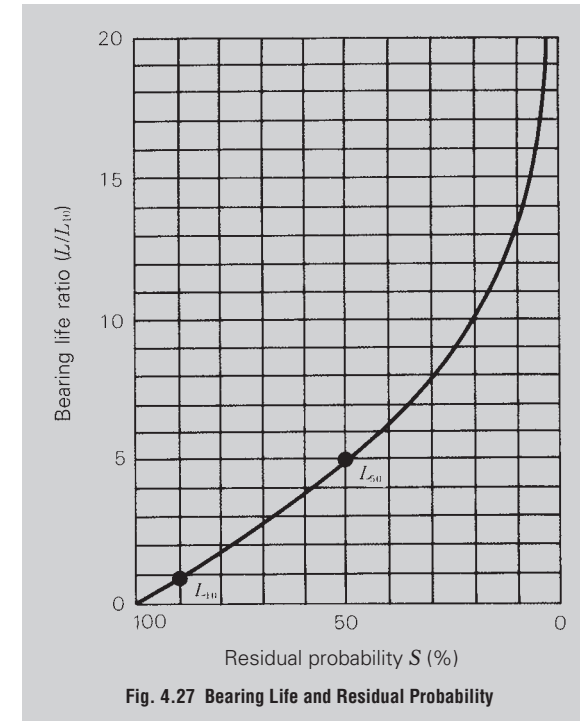

Fig. 4.27 Bearing Life and Residual Probability

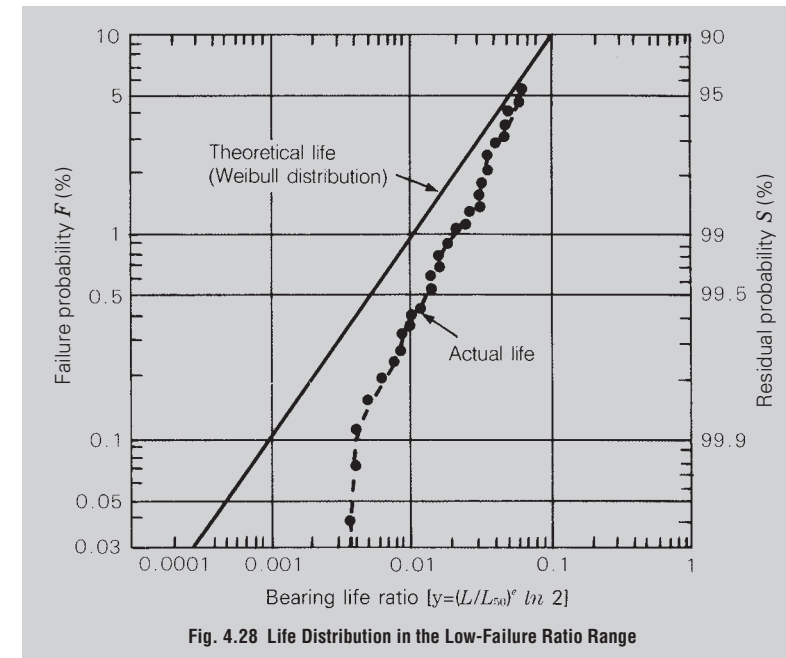

Fig. 4.28 Life Distribution in the Low-Failure Ratio Range

SELECTION OF BEARING SIZE

4.8.2 Radial Clearance and Fatigue Life

As shown in the catalog and elsewhere, the fatigue life calculation equation of rolling bearings is as follows:

$$L = \left(\frac{C}{P}\right)^p \dots\dots\dots (4.57)$$

where L : Rating fatigue life (10⁶rev)
 C : Basic dynamic load rating (N), {kgf}
 P : Dynamic equivalent load (N), {kgf}
 p : Index Ball bearing p=3,

$$\text{Roller bearing } p = \frac{10}{3}$$

The rating fatigue life L for a radial bearing in this case requires the load distribution in the bearing corresponds to the state with the load factor $\epsilon = 0.5$ (Fig. 4.29).

The load distribution with $\epsilon=0.5$ is obtained when the bearing radial internal clearance is zero. In this sense, the normal fatigue life calculation is intended to obtain a value when the clearance is zero. When the effect of the radial clearance is taken into account, the bearing fatigue life can be calculated. Equations (4.58) and (4.59) can be established between the bearing radial clearance Δ_r and a function $f(\epsilon)$ of load factor ϵ :

For deep groove ball bearings:

$$f(\epsilon) = \frac{\Delta_r \cdot D_w^{1/3}}{0.00044 \left(\frac{F_r}{Z}\right)^{2/3}} \dots\dots\dots (N) \dots\dots\dots (4.58)$$

$$f(\epsilon) = \frac{\Delta_r \cdot D_w^{1/3}}{0.002 \left(\frac{F_r}{Z}\right)^{2/3}} \dots\dots\dots \{kgf\}$$

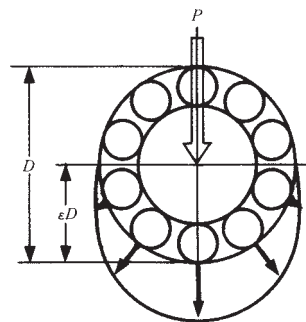

Fig. 4.29 Load Distribution With $\epsilon = 0.5$

For cylindrical roller bearings:

$$f(\epsilon) = \frac{\Delta_r \cdot L_{we}^{0.8}}{0.000077 \left(\frac{F_r}{Z \cdot i}\right)^{0.9}} \dots\dots\dots (N) \dots\dots\dots (4.59)$$

$$f(\epsilon) = \frac{\Delta_r \cdot L_{we}^{0.8}}{0.0006 \left(\frac{F_r}{Z \cdot i}\right)^{0.9}} \dots\dots\dots \{kgf\}$$

where Δ_r : Radial clearance (mm)
 F_r : Radial load (N), {kgf}
 Z : Number of rolling elements
 i : No. of rows of rolling elements
 D_w : Ball diameter (mm)
 L_{we} : Effective roller length (mm)
 L_ϵ : Life with clearance of Δ_r
 L : Life with zero clearance, obtained from Equation (4.57)

The relationship between load factor ϵ and $f(\epsilon)$ and the life ratio L_ϵ/L , when radial internal clearance Δ_r exists is shown in Table 4.13.

Fig. 4.30 shows the relationship between the radial clearance and bearing fatigue life in example 6208 and NU208 bearings.

Table 4.13 ϵ and $f(\epsilon)$, L_ϵ/L

ϵ	Deep Groove Ball Bearing		Cylindrical Roller Bearing	
	$f(\epsilon)$	$\frac{L_\epsilon}{L}$	$f(\epsilon)$	$\frac{L_\epsilon}{L}$
0.1	33.713	0.294	51.315	0.220
0.2	10.221	0.546	14.500	0.469
0.3	4.045	0.737	5.539	0.691
0.4	1.408	0.889	1.887	0.870
0.5	0	1.0	0	1.0
0.6	- 0.859	1.069	- 1.133	1.075
0.7	- 1.438	1.098	- 1.897	1.096
0.8	- 1.862	1.094	- 2.455	1.065
0.9	- 2.195	1.041	- 2.929	0.968
1.0	- 2.489	0.948	- 3.453	0.805
1.25	- 3.207	0.605	- 4.934	0.378
1.5	- 3.877	0.371	- 6.387	0.196
1.67	- 4.283	0.276	- 7.335	0.133
1.8	- 4.596	0.221	- 8.082	0.100
2.0	- 5.052	0.159	- 9.187	0.067
2.5	- 6.114	0.078	-11.904	0.029
3	- 7.092	0.043	-14.570	0.015
4	- 8.874	0.017	-19.721	0.005
5	-10.489	0.008	-24.903	0.002
10	-17.148	0.001	-48.395	0.0002

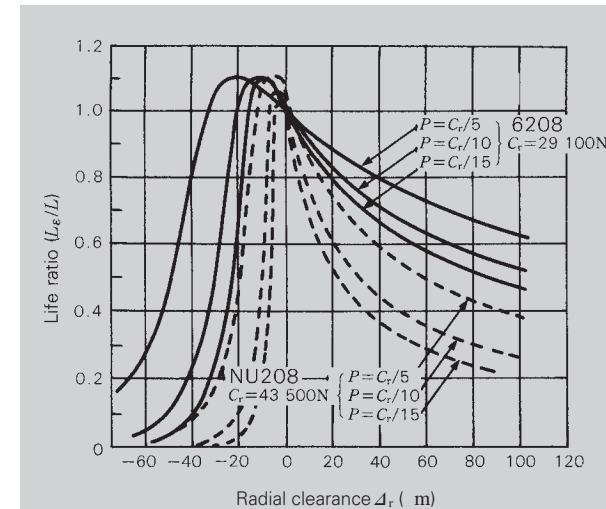

Fig. 4.30 Radial Clearance and Bearing Life Ratio

4.8.3 Misalignment of Inner/Outer Rings and Fatigue Life of Deep Groove Ball Bearings

A rolling bearing is manufactured with high accuracy, and careful attention to machining and assembly accuracies of the surrounding shafts and housing is critical for this accuracy is to be maintained. In practice however, the machining accuracy of parts around the bearing is limited, and bearings are subject to misalignment of inner/outer rings caused by the shaft deflection under external load.

The allowable misalignment is generally 0.0006 – 0.003 rad (2' to 10') but this varies depending on the size of the deep groove ball bearing, internal clearance during operation, and load.

This section introduces the relationship between the misalignment of inner/outer rings and fatigue life. Four Series 62 and 63 deep groove ball bearings of different sizes were selected as examples.

Assume the fatigue life without misalignment as $L_{\theta=0}$ and the fatigue life with misalignment as L_{θ} . The effect of the misalignment on the fatigue life may be found by calculating $L_{\theta}/L_{\theta=0}$. Results are shown in Figs. 4.31 to 4.34.

To represent ordinary running conditions in calculations, radial load F_r (N) {kgf} and axial load F_a (N) {kgf} were assumed to be approximately 10 %

(normal load) and 1 % (light preload) of the dynamic load rating C_r (N) {kgf} respectively. Normal radial clearance was used and the shaft fit was set to around j5. Decrease of the internal clearance due to expansion of the inner ring was also taken into account.

Moreover, assuming that the temperature difference between the inner and outer rings was 5 °C during operation, inner/outer ring misalignment, $L_{\theta}/L_{\theta=0}$ was calculated for the maximum, minimum, and mean effective clearances.

As shown in Figs. 4.31 to 4.34, degradation of the fatigue life is limited to 5 to 10 % or less when the misalignment ranges from 0.0006 to 0.003 rad (2' to 10'), thus not presenting much of a problem.

When misalignment exceeds a certain limit however, the fatigue life degrades rapidly as shown in the figures; therefore, pay careful attention to this matter.

When the clearance is small, not much effect is observed as long as misalignment is also small, as shown in the figures; however, life decreases substantially when misalignment increases. As previously mentioned, aim to minimize mounting error as much as possible.

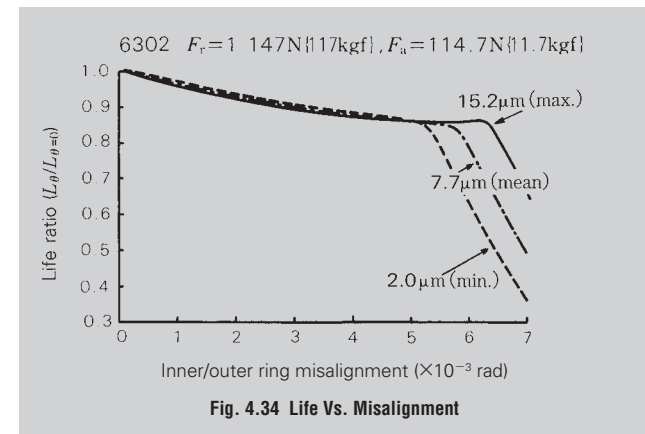
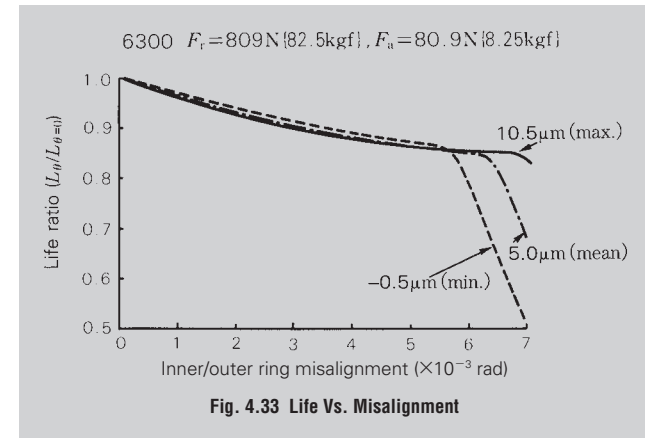
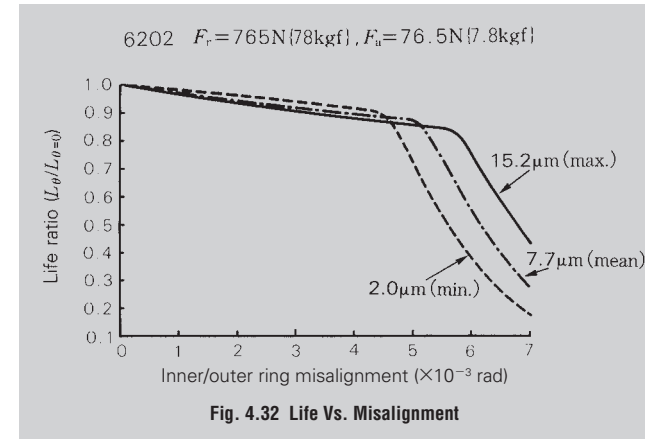
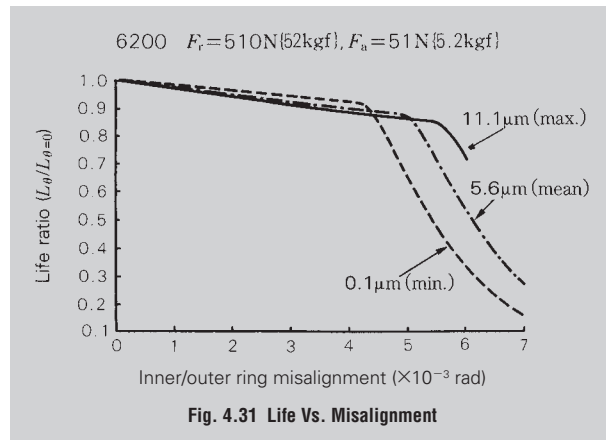

4.8.4 Misalignment of Inner/Outer Rings and Fatigue Life of Cylindrical Roller Bearings

When a shaft supported by rolling bearings is deflected or there is some inaccuracy in a shoulder, misalignment arises between the inner and outer rings of the bearings, thereby lowering their fatigue life. The degree of degradation depends on bearing type, interior design, radial internal clearance, and magnitude of load during operation.

The relationship between the misalignment of inner/outer rings and fatigue life was determined with standard NU215 and NU315 cylindrical roller bearings, as shown in Figs. 4.35 to 4.38.

In these figures, the horizontal axis shows the misalignment of inner/outer rings (rad) while the vertical axis shows the fatigue life ratio $L_{\theta}/L_{\theta=0}$. The fatigue life without misalignment is $L_{\theta=0}$ and the fatigue life with misalignment is L_{θ} .

Figs. 4.35 and 4.36 show the life ratio for bearings under constant load (10 % of basic dynamic load rating C_r of a bearing) when the internal clearance is normal, C3, or C4. Figs. 4.37 and 4.38 show the life ratio for bearings with constant clearance (normal clearance) when the load is 5 %, 10 %, and 20 % of the basic dynamic load rating C_r .

Note that the median effective clearance in these examples was determined using m5/H7 fits and a temperature difference of 5°C between the inner and outer rings.

The fatigue life ratio for the clearance and load shows the same trend as in the case of other cylindrical roller bearings; however, the life ratio itself differs among bearing series and dimensions, with life degradation rapid in Series 22 and 23 bearings (wide type). Use of a specially designed bearing is advised when considerable misalignment is expected during application.

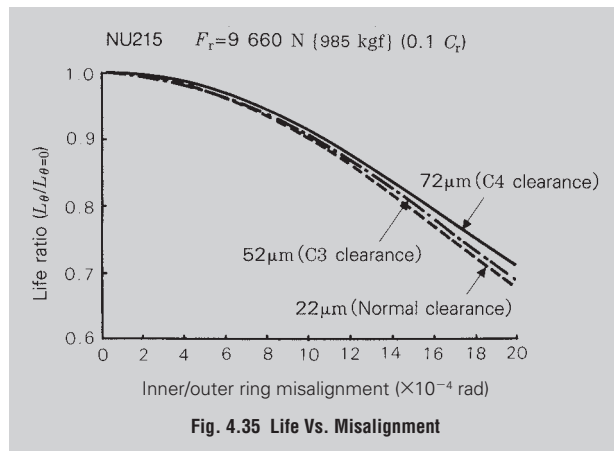

Fig. 4.35 Life Vs. Misalignment

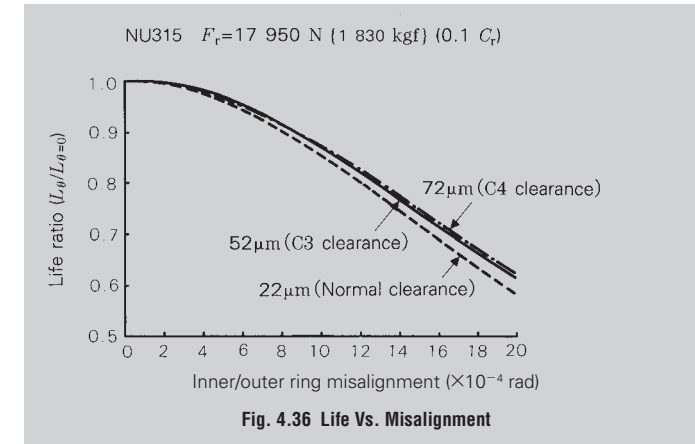

Fig. 4.36 Life Vs. Misalignment

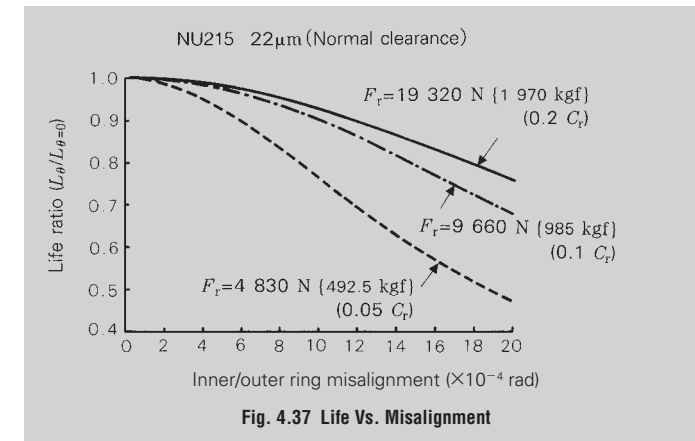

Fig. 4.37 Life Vs. Misalignment

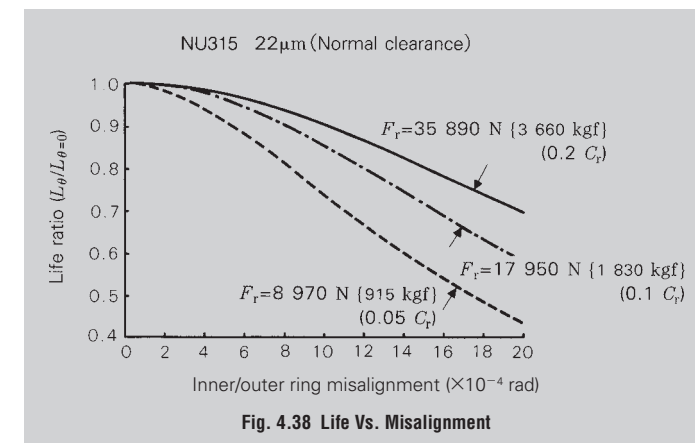

Fig. 4.38 Life Vs. Misalignment

4.8.5 Oil Film Parameters and Rolling Fatigue Life

As evidenced by numerous experiments and experiences, the rolling fatigue life of rolling bearings is closely related to lubrication.

The rolling fatigue life is expressed by the maximum number of rotations that a bearing can endure until the raceway or rolling surface of a bearing develops fatigue in the material resulting in flaking of the surface due to cyclic stress. Such flaking begins with either microscopic non-uniform portions (such as nonmetallic inclusions or cavities) in the material or with microscopic defects in the material surface (such as extremely small cracks, surface damage, or dents caused by contact between extremely small projections in the raceway or rolling surface). The former flaking is called subsurface-originating flaking while the latter is surface-originating flaking.

The oil film parameter λ , which is the ratio between the resultant oil film thickness and surface roughness, expresses whether or not the lubrication at the rolling contact surface is satisfactory. The effect of the oil film grows with increasing λ . Namely, when λ is large (around 3 in general), surface-originating flaking due to contact between extremely small projections in the surface is less likely to occur. If the surface is free from defects (flaws, dents, etc.), the life is determined mainly by subsurface-originating flaking. On the other hand, a decrease in λ tends to cause surface-originating flaking, resulting in degradation of the bearing's life. This state is shown in Fig. 4.39.

NSK has performed life experiments with about 370 bearings within the range of $\lambda = 0.3-3$ and with different lubricants and bearing materials (● and ▲ in Fig. 4.40). Fig. 4.40 shows a summary of the principal experiments reported until now. As is evident in the figures, life decreases rapidly at around $\lambda \cong 1$ when compared with life values at around $\lambda = 3-4$ where life changes at a slower rate. Life becomes about 1/10 or less at $\lambda \leq 0.5$ due to severe surface-originating flaking.

Accordingly, to extend the fatigue life of rolling bearings, increase the oil film parameter (ideally to a value above 3) by improving lubrication conditions.

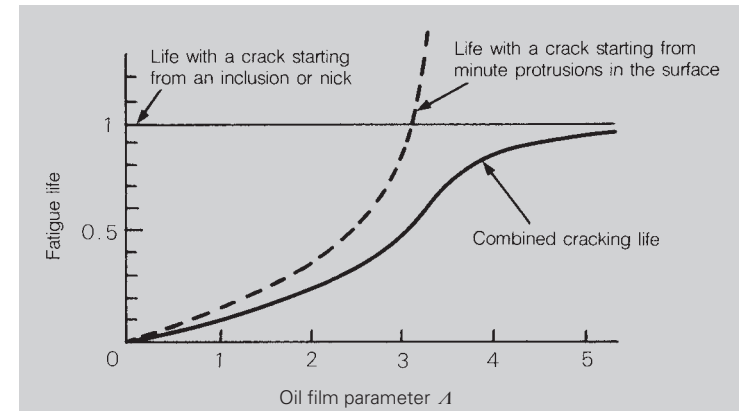

Fig. 4.39 Life According to Oil Film Parameter λ (Tallian, et al.)

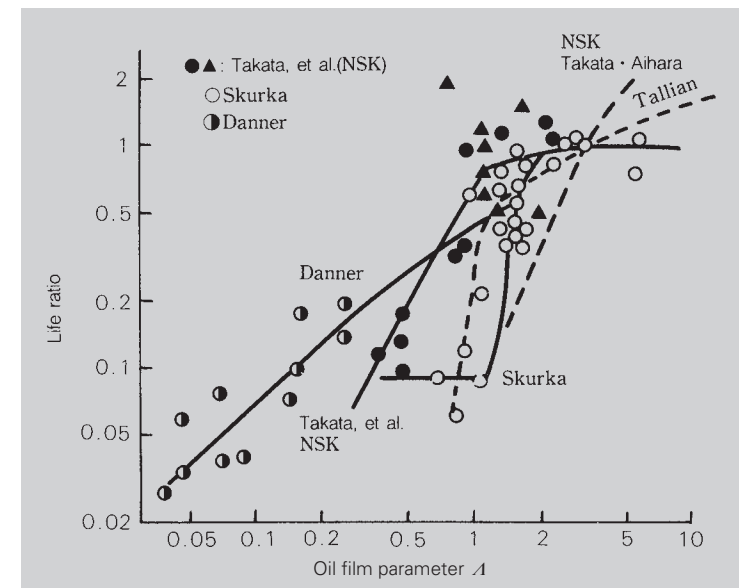

Fig. 4.40 Typical Experiment With Oil Film Parameter λ and Rolling Fatigue Life (Expressed with reference to the life at $\lambda = 3$)

SELECTION OF BEARING SIZE

4.8.6 EHL Oil Film Parameter Calculation Diagram

Lubrication of rolling bearings can be expressed by the theory of elastohydrodynamic lubrication (EHL). Introduced below is a method to determine the oil film parameter (oil film to surface roughness ratio), the most critical component in EHL.

(1) Oil Film Parameter

The raceway surfaces and rolling surfaces of a bearing are extremely smooth, but have fine irregularities when viewed through a microscope. As the EHL oil film thickness is in the same order as the surface roughness, lubrication conditions cannot be discussed without considering this surface roughness. For example, given a particular mean oil film thickness, there are two conditions that may occur depending on the surface roughness. One consists of complete separation of the two surfaces by means of the oil film (Fig. 4.41 (a)). The other consists of metal contact between surface projections (Fig. 4.41 (b)). The degradation of lubrication and surface damage is attributed to case (b). The symbol lambda (λ) represents the ratio between the oil film thickness and roughness. It is widely employed as the oil film parameter in the study and application of EHL.

$$\lambda = h/\sigma \quad (4.60)$$

where h : EHL oil film thickness
 σ : Combined roughness ($\sqrt{\sigma_1^2 + \sigma_2^2}$)

σ_1, σ_2 : Root mean square (rms) roughness of each contact surface

The oil film parameter may be correlated to the formation of the oil film, and the degree of lubrication can be divided into three zones as shown in Fig. 4.42.

(2) Oil Film Parameter Calculation Diagram

The **Dowson-Higginson** minimum oil film thickness equation shown below is used for figures:

$$H_{min} = 2.65 \frac{G^{0.54} U^{0.7}}{W^{0.13}} \quad (4.61)$$

Use the oil film thickness that reflects the inner ring under maximum rolling element load (where thickness is minimum).

Equation (4.61) can be expressed by grouping variables as follows: (R) for speed, (A) for viscosity, (F) for load, and (J) for bearing technical specifications, with t as a constant:

$$\lambda = t \cdot R \cdot A \cdot F \cdot J \quad (4.62)$$

R and A may be quantities not dependent on the bearing. When the load P is assumed to be between 98 N {10 kgf} and 98 kN {10 tf}, F changes by 2.54 times as $F \propto P^{-0.13}$. Since the actual load is usually determined from bearing size however, such change may be limited to 20 to 30 %. As a result, F is handled together with term J [$F = F(J)$]. Traditional Equation (4.62) can therefore be grouped as shown below:

$$\lambda = T \cdot R \cdot A \cdot D \quad (4.63)$$

where T : Factor determined by the bearing Type
 R : Factor related to Rotation speed
 A : Factor related to viscosity (viscosity grade α : Alpha)
 D : Factor related to bearing Dimensions

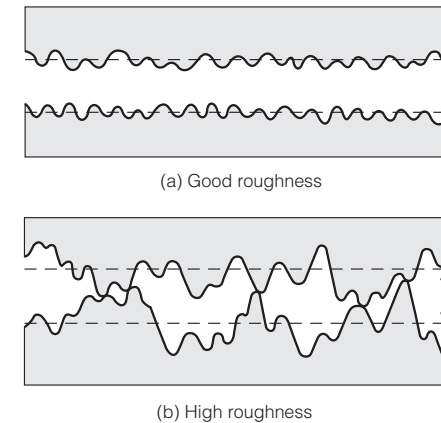

Fig. 4.41 Oil Film and Surface Roughness

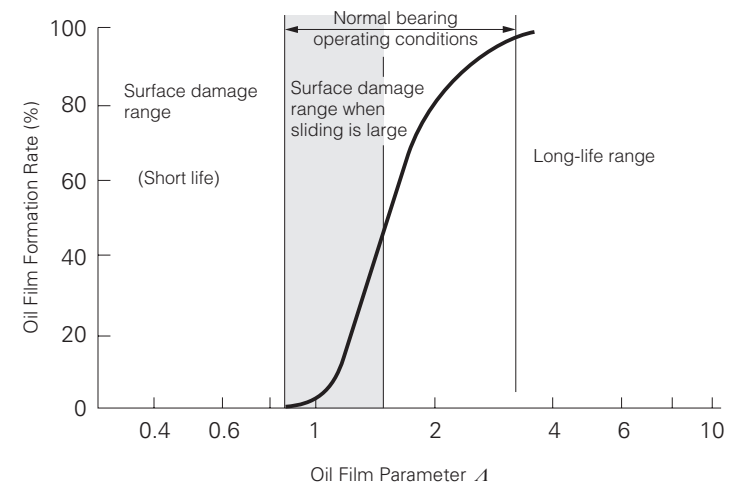

Fig. 4.42 Effect of Oil Film on Bearing Performance

SELECTION OF BEARING SIZE

The vitally important oil film parameter A is expressed by a simplified equation shown below. The fatigue life of rolling bearings becomes shorter when A is smaller. In the equation $A = T \cdot R \cdot A \cdot D$ variables include A for oil viscosity η_0 (mPa·s, {cp}), R for speed n (min⁻¹), and D for bearing bore diameter d (mm). The calculation procedure is described below.

(i) Determine the value of T from the bearing type (Table 4.14).

(ii) Determine the R value for n (min⁻¹) from Fig. 4.43.

(iii) Determine A from the absolute viscosity (mPa·s, {cp}) and kind of oil in Fig. 4.44.

Generally, the kinematic viscosity ν_0 (mm²/s, {cSt}) is used and conversion is made as follows:

$$\eta_0 = \rho \cdot \nu_0 \quad (4.64)$$

ρ refers to oil density (g/cm³) and uses the approximate values shown below:

- Mineral oil $\rho = 0.85$
- Silicon oil $\rho = 1.0$
- Diester oil $\rho = 0.9$

When the mineral oil could be naphthene or paraffin, use the paraffin curve shown in Fig. 4.44.

(iv) Determine the value of D from the Diameter Series and bore diameter d (mm) in Fig. 4.45.

(v) The product of the above values is used as the oil film parameter.

Table 4.14 T Value

Bearing Type	T Value
Ball bearing	1.5
Cylindrical roller bearing	1.0
Tapered roller bearing	1.1
Spherical roller bearing	0.8

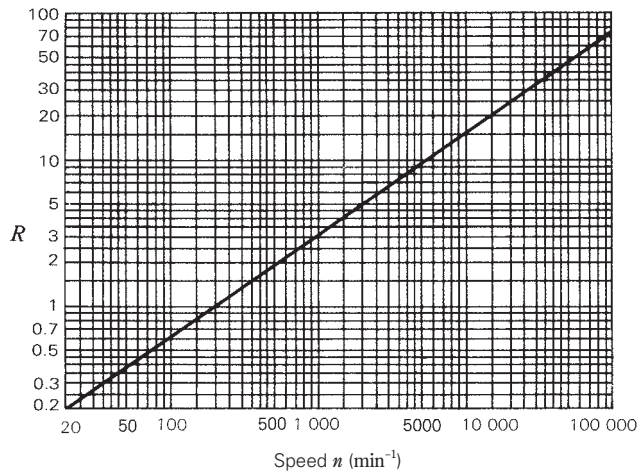

Fig. 4.43 Speed R

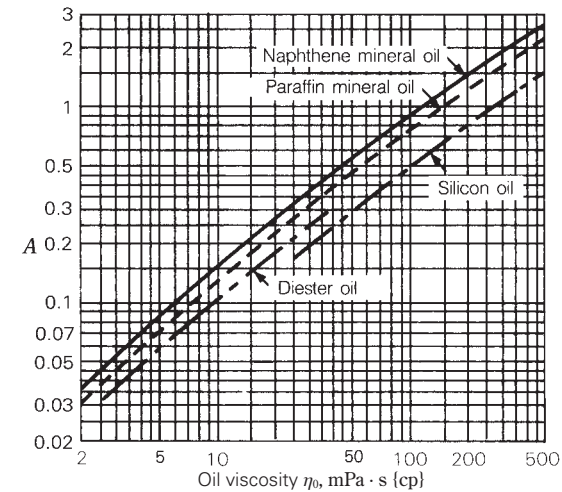

Fig. 4.44 Lubricant Viscosity A

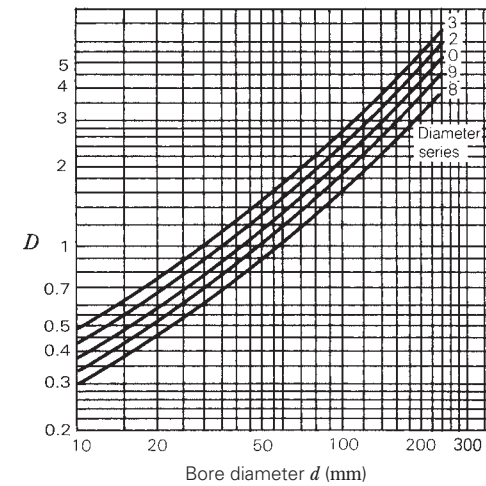

Fig. 4.45 Bearing Specifications D

SELECTION OF BEARING SIZE

Example EHL oil film parameter calculations are described below:

Example 1

Determine the oil film parameter when deep groove ball bearing 6312 is operated with paraffin mineral oil ($\eta_0 = 30 \text{ mPa}\cdot\text{s}$, {cp}) at a speed of $n = 1\,000 \text{ min}^{-1}$.

Solution

$d = 60 \text{ mm}$ and $D = 130 \text{ mm}$ from the bearing catalog.
 $T = 1.5$ from Table 4.18
 $R = 3.0$ from Fig. 4.43
 $A = 0.31$ from Fig. 4.44
 $D = 1.76$ from Fig. 4.45
 Accordingly, $\lambda = 2.5$

Example 2

Determine the oil film parameter when cylindrical roller bearing NU240 is operated with paraffin mineral oil ($\eta_0 = 10 \text{ mPa}\cdot\text{s}$, {cp}) at a speed of $n = 2\,500 \text{ min}^{-1}$.

Solution

$d = 200 \text{ mm}$ and $D = 360 \text{ mm}$ from the bearing catalog.
 $T = 1.0$ from Table 4.18
 $R = 5.7$ from Fig. 4.43
 $A = 0.13$ from Fig. 4.44
 $D = 4.8$ from Fig. 4.45
 Accordingly, $\lambda = 3.6$

(3) Effects of Oil Shortage and Shearing Heat Generation

The oil film parameter obtained above is applicable when the contact inlet is fully flooded with oil and the temperature at the inlet is constant (isothermal). However, these conditions may not be satisfied depending on lubrication and operating conditions. One such condition is called starvation, and in this case, the actual oil film parameter may become smaller than that determined by Equation (4.64). Starvation may occur if lubrication becomes limited. In this condition, the guideline for adjusting the oil film parameter is 50 to 70 % of the value obtained from Equation (4.64).

Another effect is the localized rise of oil temperature in the contact inlet due to heavy shearing during high-speed operation, resulting in a decrease of oil viscosity. In this case, the oil film parameter becomes smaller than the theoretical isothermal value. The effect of shearing heat generation was analyzed by Murch and Wilson, who established a decrease factor for the oil film parameter. An approximation using the viscosity and speed (pitch diameter of rolling element set $D_{pw} \times$ rotating speed per minute n) is shown in Fig. 4.46. By multiplying the oil film parameter determined in the previous section by this decrease factor Hi , an oil film parameter considering the shearing heat generation is obtained:

$$\lambda = Hi \cdot T \cdot R \cdot A \cdot D \dots\dots\dots (4.65)$$

Note that the average of the bore and outside diameters of the bearings may be used as the pitch diameter D_{pw} (d_m) of the set of rolling elements.

Conditions for the calculation of Example 1 include $d_m n = 9.5 \times 10^4$ and $\eta_0 = 30 \text{ mPa}\cdot\text{s}$, {cp} and Hi nearly equivalent to 1, as evident from Fig. 4.46. Shearing heat generation therefore has almost no effect. Conditions for Example 2 are $d_m n = 7 \times 10^5$ and $\eta_0 = 10 \text{ mPa}\cdot\text{s}$, {cp} and $Hi = 0.76$, meaning that the oil film parameter is smaller by about 25%. Accordingly, λ is actually 2.7, not 3.6.

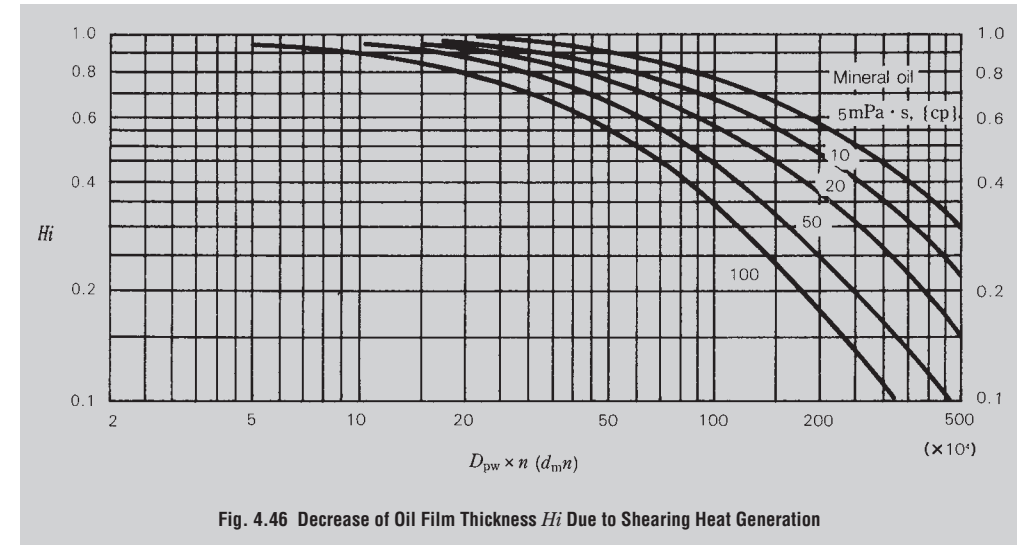

Fig. 4.46 Decrease of Oil Film Thickness Hi Due to Shearing Heat Generation

SELECTION OF BEARING SIZE

4.8.7 Load Calculation for Gears

(1) Calculation of Loads on Spur, Helical, and Double-Helical Gears

Since they are both mechanical elements, there is an extremely close relationship between gears and rolling bearings. Gear units, which are widely used in machines, are almost always used with bearings. Rating life calculation and selection of bearings to be used in gear units are based on the load at the gear meshing point.

The load at the gear meshing point is calculated as follows:

Spur Gear:

$$P_1 = P_2 = \frac{9\,550\,000H}{n_1 \left(\frac{d_{p1}}{2}\right)} = \frac{9\,550\,000H}{n_2 \left(\frac{d_{p2}}{2}\right)} \dots\dots\dots \text{(N)}$$

$$= \frac{974\,000H}{n_1 \left(\frac{d_{p1}}{2}\right)} = \frac{974\,000H}{n_2 \left(\frac{d_{p2}}{2}\right)} \dots\dots \text{{kgf}}$$

$$S_1 = S_2 = P_1 \tan \alpha$$

The magnitudes of forces P_2 and S_2 applied to the driven gear are the same as P_1 and S_1 respectively, but the direction is opposite.

Helical Gear:

$$P_1 = P_2 = \frac{9\,550\,000H}{n_1 \left(\frac{d_{p1}}{2}\right)} = \frac{9\,550\,000H}{n_2 \left(\frac{d_{p2}}{2}\right)} \dots\dots\dots \text{(N)}$$

$$= \frac{974\,000H}{n_1 \left(\frac{d_{p1}}{2}\right)} = \frac{974\,000H}{n_2 \left(\frac{d_{p2}}{2}\right)} \dots\dots \text{{kgf}}$$

$$S_1 = S_2 = \frac{P_1 \tan \alpha_n}{\cos \beta}$$

$$T_1 = T_2 = P_1 \tan \beta$$

The magnitudes of the forces P_2 , S_2 , and T_2 applied to the driven gear are the same as P_1 , S_1 , and T_1 respectively, but the direction is opposite.

Double-Helical Gear:

$$P_1 = P_2 = \frac{9\,550\,000H}{n_1 \left(\frac{d_{p1}}{2}\right)} = \frac{9\,550\,000H}{n_2 \left(\frac{d_{p2}}{2}\right)} \dots\dots\dots \text{(N)}$$

$$= \frac{974\,000H}{n_1 \left(\frac{d_{p1}}{2}\right)} = \frac{974\,000H}{n_2 \left(\frac{d_{p2}}{2}\right)} \dots\dots \text{{kgf}}$$

$$S_1 = S_2 = \frac{P_1 \tan \alpha_n}{\cos \beta}$$

where P : Tangential force (N), {kgf}
 S : Separating force (N), {kgf}
 T : Thrust (N), {kgf}
 H : Transmitted power (kW)
 n : Speed (min^{-1})
 d_p : Pitch diameter (mm)
 α : Gear pressure angle
 α_n : Gear normal pressure angle
 β : Twist angle

Subscript 1: Driving gear
 Subscript 2: Driven gear

In the case of double-helical gears, thrust of the helical gears offsets each other and thus only tangential and separating forces act. For the directions of tangential, separating, and thrust forces, please refer to Figs. 4.47 and 4.48.

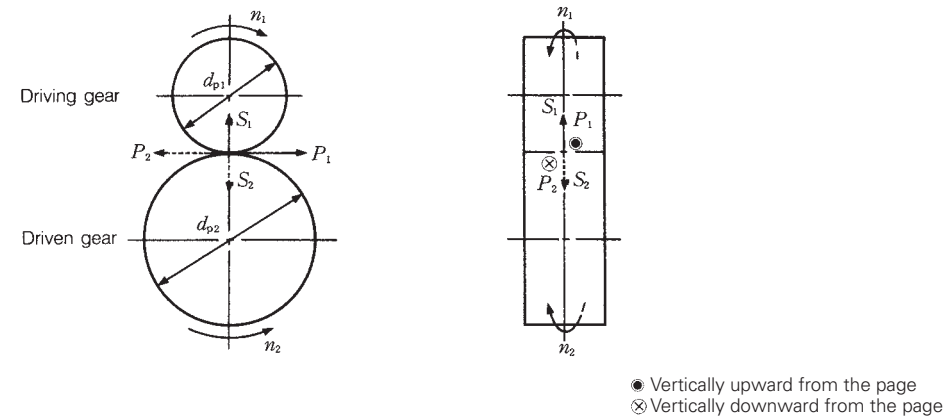

Fig. 4.47 Spur Gear

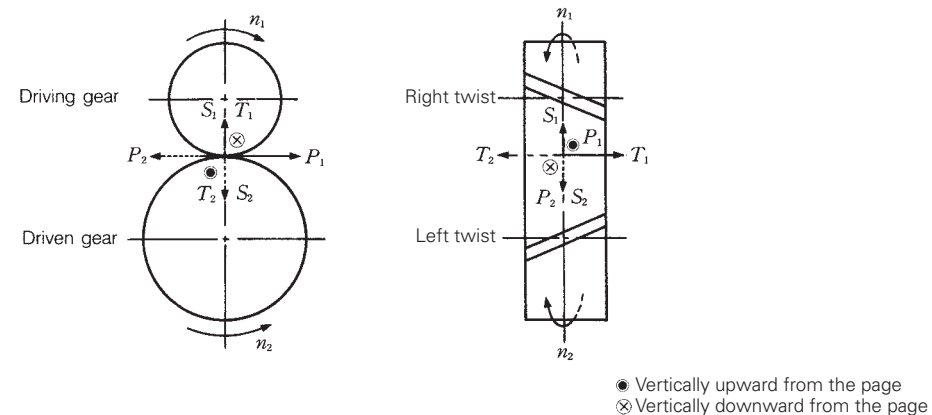

Fig. 4.48 Helical Gear

The thrust direction of the helical gear varies depending on the gear running direction, gear twist direction, and whether the gear is driving or driven. The directions are as follows:

The force on the bearing is determined as follows:

Tangential force:

$$P_1 = P_2 = \frac{9\,550\,000H}{n_1 \left(\frac{d_{p1}}{2}\right)} = \frac{9\,550\,000H}{n_2 \left(\frac{d_{p2}}{2}\right)} \dots\dots\dots \text{(N)}$$

$$= \frac{974\,000H}{n_1 \left(\frac{d_{p1}}{2}\right)} = \frac{974\,000H}{n_2 \left(\frac{d_{p2}}{2}\right)} \dots\dots \text{{kgf}}$$

Separating force: $S_1 = S_2 = P_1 \frac{\tan\alpha_n}{\cos\beta}$

Thrust: $T_1 = T_2 = P_1 \cdot \tan\beta$

The same method can be applied to bearings C and D.

Table 4.15

Load Classification	Bearing A	Bearing B
From P_1	$P_A = \frac{b}{a+b} P_1$ ⊗	$P_B = \frac{a}{a+b} P_1$ ⊗
From S_1	$S_A = \frac{b}{a+b} S_1$ ↑	$S_B = \frac{a}{a+b} S_1$ ↑
From T_1	$U_A = \frac{d_{p1}/2}{a+b} T_1$ ↑	$U_B = \frac{d_{p1}/2}{a+b} T_1$ ↓
Combined Radial Load	$F_{RA} = \sqrt{P_A^2 + (S_A + U_A)^2}$	$F_{RB} = \sqrt{P_B^2 + (S_B - U_B)^2}$
Axial Load	$F_a = T_1$ ←	

Load directions shown reference the left side of Fig. 4.49.

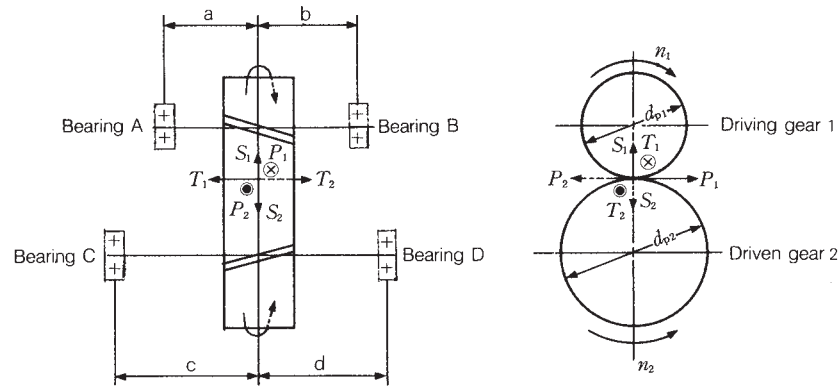

Fig. 4.49

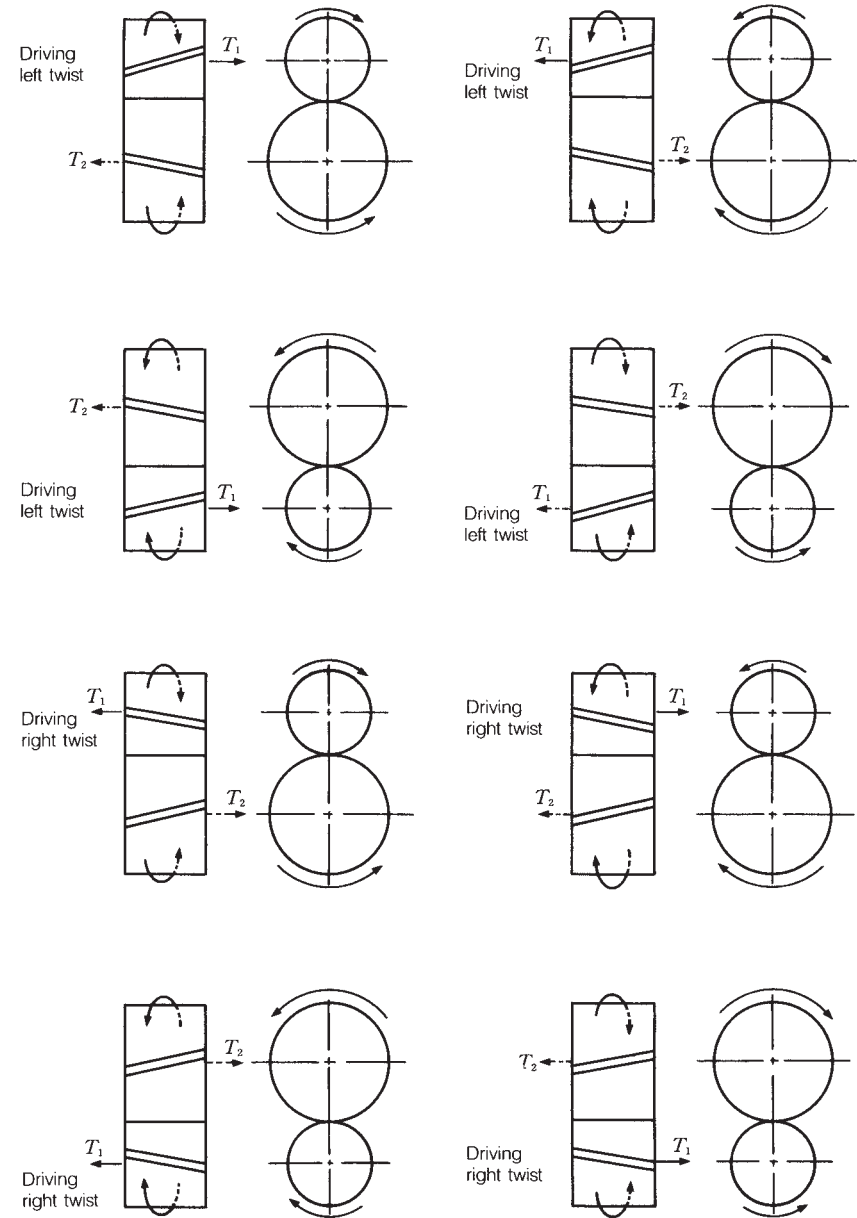

Fig. 4.50 Thrust Direction

SELECTION OF BEARING SIZE

(2) Calculation of Load on Straight Bevel Gears

The load at the meshing point of straight bevel gears is calculated as follows:

$$P_1 = P_2 = \frac{9\,550\,000H}{n_1 \left(\frac{D_{m1}}{2}\right)} = \frac{9\,550\,000H}{n_2 \left(\frac{D_{m2}}{2}\right)} \dots\dots\dots (N)$$

$$= \frac{974\,000H}{n_1 \left(\frac{D_{m1}}{2}\right)} = \frac{974\,000H}{n_2 \left(\frac{D_{m2}}{2}\right)} \dots\dots\dots \{kgf\}$$

$D_{m1} = d_{p1} - w \sin \delta_1$
 $D_{m2} = d_{p2} - w \sin \delta_2$

$S_1 = P_1 \tan \alpha_n \cos \delta_1$
 $S_2 = P_2 \tan \alpha_n \cos \delta_2$

$T_1 = P_1 \tan \alpha_n \sin \delta_1$
 $T_2 = P_2 \tan \alpha_n \sin \delta_2$

where D_m : Average pitch diameter (mm)
 d_p : Pitch diameter (mm)
 w : Gear width (pitch line length) (mm)
 α_n : Gear normal pressure angle
 δ : Pitch cone angle

Generally, $\delta_1 + \delta_2 = 90^\circ$. In this case, S_1 and T_2 (or S_2 and T_1) are the same in magnitude but opposite in direction. S/P and T/P for δ are shown in Fig. 4.53. The load on the bearing can be calculated as shown below.

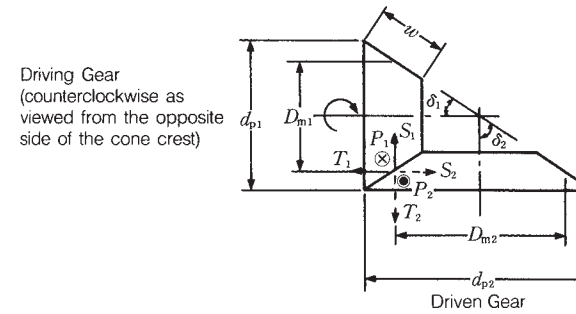

Fig. 4.51

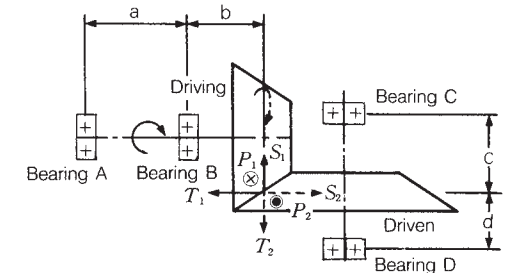

Fig. 4.52

Table 4.16

● Vertically upward from the page
 ⊗ Vertically downward from the page

Load Classification	Bearing A	Bearing B	Bearing C	Bearing D
Radial Load	From P $P_A = \frac{b}{a} P_1$ ●	$P_B = \frac{a+b}{a} P_1$ ⊗	$P_C = \frac{d}{c+d} P_2$ ●	$P_D = \frac{c}{c+d} P_2$ ●
	From S $S_A = \frac{b}{a} S_1$ ↓	$S_B = \frac{a+b}{a} S_1$ ↑	$S_C = \frac{d}{c+d} S_2$ →	$S_D = \frac{c}{c+d} S_2$ →
	From T $U_A = \frac{D_{m1}}{2 \cdot a} T_1$ ↑	$U_B = \frac{D_{m1}}{2 \cdot a} T_1$ ↓	$U_C = \frac{D_{m2}}{2(c+d)} T_2$ ←	$U_D = \frac{D_{m2}}{2(c+d)} T_2$ →
Combined Radial Load	$F_{rA} = \sqrt{P_A^2 + (S_A - U_A)^2}$	$F_{rB} = \sqrt{P_B^2 + (S_B - U_B)^2}$	$F_{rC} = \sqrt{P_C^2 + (S_C - U_C)^2}$	$F_{rD} = \sqrt{P_D^2 + (S_D + U_D)^2}$
Axial Load	$F_a = T_1$ ←		$F_a = T_2$ ↓	

Load directions shown reference Fig. 4.52.

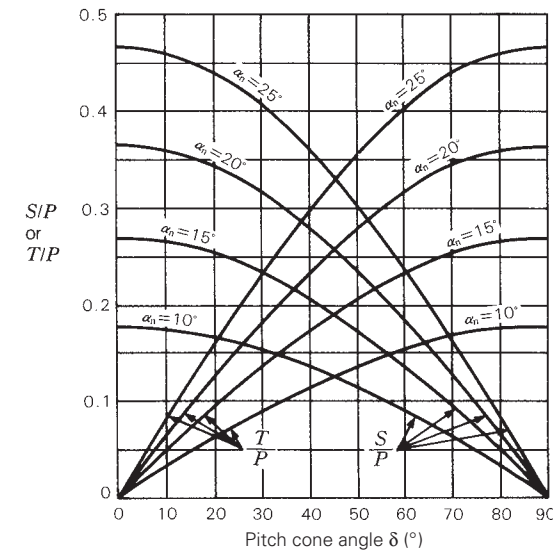

Fig. 4.53

SELECTION OF BEARING SIZE

(3) Calculation of Load on Spiral Bevel Gears

In the case of spiral bevel gears, the magnitude and direction of loads at the meshing point vary depending on the running direction and gear twist direction. The running direction is either clockwise or counterclockwise as viewed from the side opposite of the gears (Fig. 4.54). The gear twist direction is classified as shown in Fig. 4.55. The force at the meshing point is calculated as follows:

$$P_1 = P_2 = \frac{9\,550\,000H}{n_1 \left(\frac{D_{m1}}{2}\right)} = \frac{9\,550\,000H}{n_2 \left(\frac{D_{m2}}{2}\right)}$$

..... (N)

$$= \frac{974\,000H}{n_1 \left(\frac{D_{m1}}{2}\right)} = \frac{974\,000H}{n_2 \left(\frac{D_{m2}}{2}\right)} \text{ \{kgf\}}$$

where α_n : Gear normal pressure angle
 β : Twisting angle
 δ : Pitch cone angle
 w : Gear width (mm)
 D_m : Average pitch diameter (mm)
 d_p : Pitch diameter (mm)

Note that the following applies:

$$D_{m1} = d_{p1} - w \sin \delta_1$$

$$D_{m2} = d_{p2} - w \sin \delta_2$$

The separating force S and thrust T depend on running direction and gear twist direction as follows:

(i) Clockwise with right twisting or counterclockwise with left twisting

Driving Gear

Separating Force

$$S_1 = \frac{P}{\cos \beta} (\tan \alpha_n \cos \delta_1 + \sin \beta \sin \delta_1)$$

Thrust

$$T_1 = \frac{P}{\cos \beta} (\tan \alpha_n \sin \delta_1 - \sin \beta \cos \delta_1)$$

Driven Gear

Separating Force

$$S_2 = \frac{P}{\cos \beta} (\tan \alpha_n \cos \delta_2 - \sin \beta \sin \delta_2)$$

Thrust

$$T_2 = \frac{P}{\cos \beta} (\tan \alpha_n \sin \delta_2 + \sin \beta \cos \delta_2)$$

(ii) Counterclockwise with right twist or clockwise with left twist

Driving Gear

Separating Force

$$S_1 = \frac{P}{\cos \beta} (\tan \alpha_n \cos \delta_1 - \sin \beta \sin \delta_1)$$

Thrust

$$T_1 = \frac{P}{\cos \beta} (\tan \alpha_n \sin \delta_1 + \sin \beta \cos \delta_1)$$

Driven Gear

Separating Force

$$S_2 = \frac{P}{\cos \beta} (\tan \alpha_n \cos \delta_2 + \sin \beta \sin \delta_2)$$

Thrust

$$T_2 = \frac{P}{\cos \beta} (\tan \alpha_n \sin \delta_2 - \sin \beta \cos \delta_2)$$

A positive (plus) calculation result indicates that the load is acting in a direction that separates the gears while a negative (minus) result indicates that the load is acting in a direction that brings the gears together. Generally, $\delta_1 + \delta_2 = 90^\circ$. In this case, T_1 and S_2 (S_1 and T_2) are the same in magnitude but opposite in direction. The load on the bearing can be calculated by the same method as described in Section 4.8.7 "(2) Calculation of Load on Straight Bevel Gears."

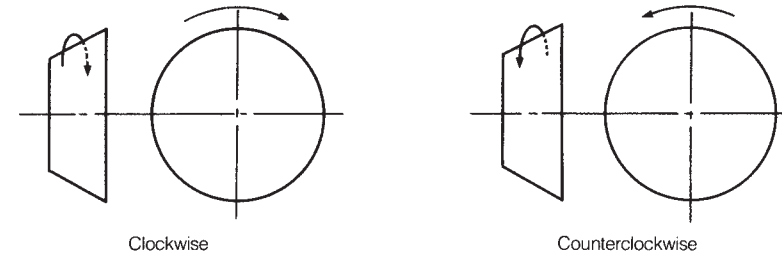

Fig. 4.54 Gear Running Direction

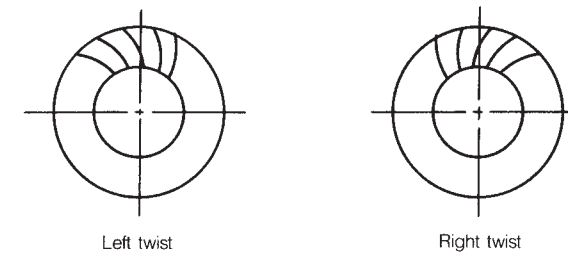

Fig. 4.55 Gear Twist Direction

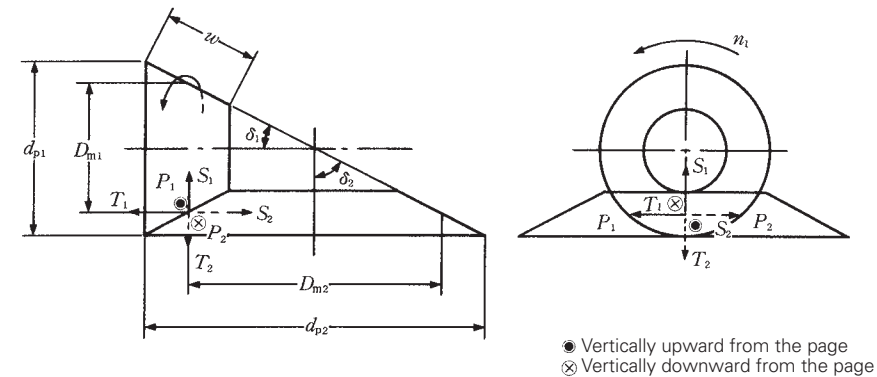

Fig. 4.56

SELECTION OF BEARING SIZE

(4) Calculation of Load on Hypoid Gears

The force acting at the meshing point of hypoid gears is calculated as follows:

$$P_1 = \frac{9\,550\,000H}{n_1 \left(\frac{D_{m1}}{2} \right)} = \frac{\cos\beta_1}{\cos\beta_2} P_2 \dots\dots\dots \text{(N)}$$

$$= \frac{974\,000H}{n_1 \left(\frac{D_{m1}}{2} \right)} = \frac{\cos\beta_1}{\cos\beta_2} P_2 \dots\dots\dots \text{{kgf}}$$

$$P_2 = \frac{9\,550\,000H}{n_2 \left(\frac{D_{m2}}{2} \right)} \dots\dots\dots \text{(N)}$$

$$= \frac{974\,000H}{n_2 \left(\frac{D_{m2}}{2} \right)} \dots\dots\dots \text{{kgf}}$$

$$D_{m1} = D_{m2} \frac{z_1}{z_2} \cdot \frac{\cos\beta_1}{\cos\beta_2}$$

$$D_{m2} = d_{p2} - w_2 \sin\delta_2$$

- where α_n : Gear normal pressure angle
 β : Twisting angle
 δ : Pitch cone angle
 w : Gear width (mm)
 D_m : Average pitch diameter (mm)
 d_p : Pitch diameter (mm)
 z : Number of teeth

The separating force S and thrust T depend on running direction and gear twist direction as follows:

(i) Clockwise with right twisting or counterclockwise with left twisting

Driving Gear
Separating Force

$$S_1 = \frac{P_1}{\cos\beta_1} (\tan\alpha_n \cos\delta_1 + \sin\beta_1 \sin\delta_1)$$

Thrust
 $T_1 = \frac{P_1}{\cos\beta_1} (\tan\alpha_n \sin\delta_1 - \sin\beta_1 \cos\delta_1)$

Driven Gear
Separating Force

$$S_2 = \frac{P_2}{\cos\beta_2} (\tan\alpha_n \cos\delta_2 - \sin\beta_2 \sin\delta_2)$$

Thrust
 $T_2 = \frac{P_2}{\cos\beta_2} (\tan\alpha_n \sin\delta_2 + \sin\beta_2 \cos\delta_2)$

(ii) Counterclockwise with right twist or clockwise with left twist

Driving Gear
Separating Force

$$S_1 = \frac{P_1}{\cos\beta_1} (\tan\alpha_n \cos\delta_1 - \sin\beta_1 \sin\delta_1)$$

Thrust
 $T_1 = \frac{P_1}{\cos\beta_1} (\tan\alpha_n \sin\delta_1 + \sin\beta_1 \cos\delta_1)$

Driven Gear
Separating Force

$$S_2 = \frac{P_2}{\cos\beta_2} (\tan\alpha_n \cos\delta_2 + \sin\beta_2 \sin\delta_2)$$

Thrust
 $T_2 = \frac{P_2}{\cos\beta_2} (\tan\alpha_n \sin\delta_2 - \sin\beta_2 \cos\delta_2)$

The positive (plus) calculation result indicates that the load is acting in a direction that separates the gears while a negative (minus) result indicates that the load is acting in a direction that brings the gears together.

For more information on running direction and gear twist direction, refer to Section 4.8.7 "(3) Calculation of Load on Spiral Bevel Gears." The load on the bearing can be calculated by the same method as described in Section 4.8.7 "(2) Calculation of Load Acting on Straight Bevel Gears."

The following calculation diagrams are used to determine the approximate value and direction of separating force S and thrust T .

How To Use

1. Mark the gear normal pressure angle α_n on the vertical scale on the side of the appropriate diagram for S or T .

2. Determine the intersection between the pitch cone angle δ and twist angle β . Match your gear configuration to the text on either side of the $\beta = 0^\circ$ line, and use that side when determining the point of intersection.
3. Draw a line through the two points and the opposite vertical scale. The point where the line intersects the opposite vertical axis gives the ratio S/P or T/P (%) of the separating force S or thrust T to the tangential force P .

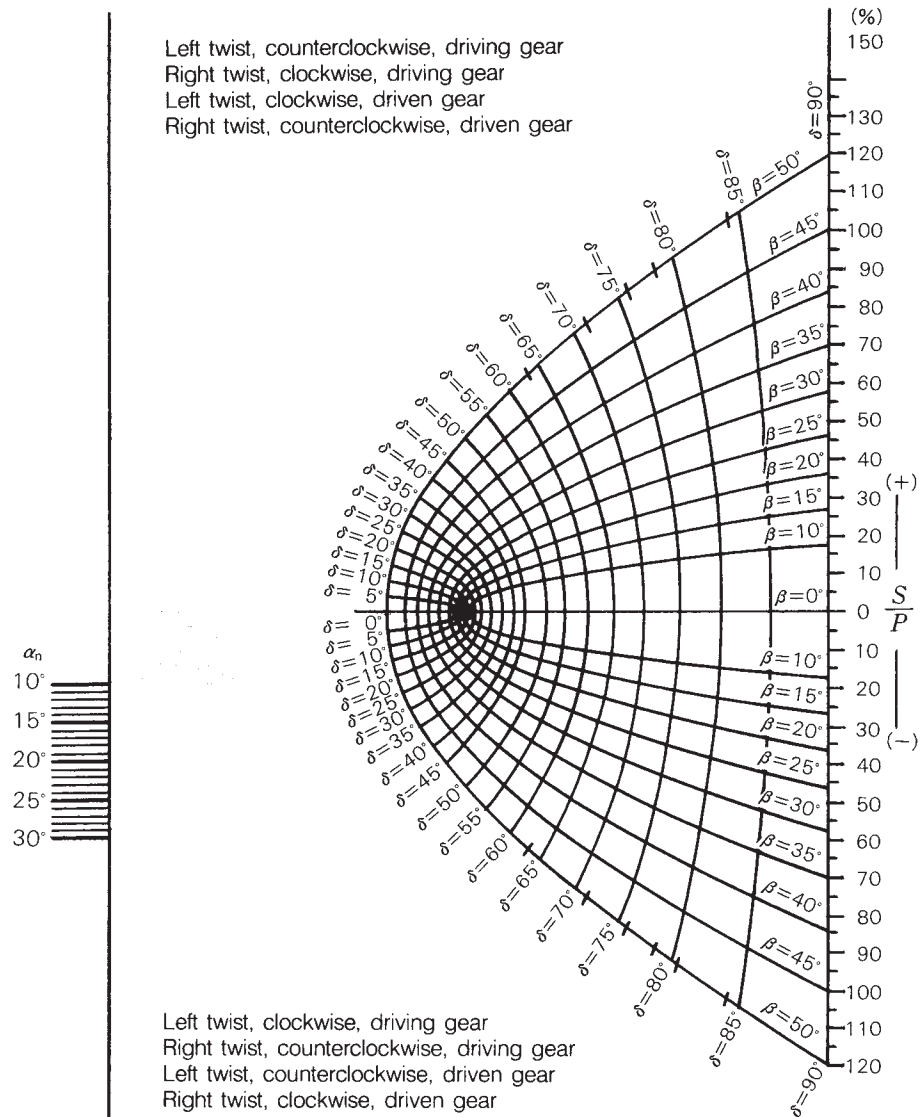

Calculation Diagram for Separating Force S

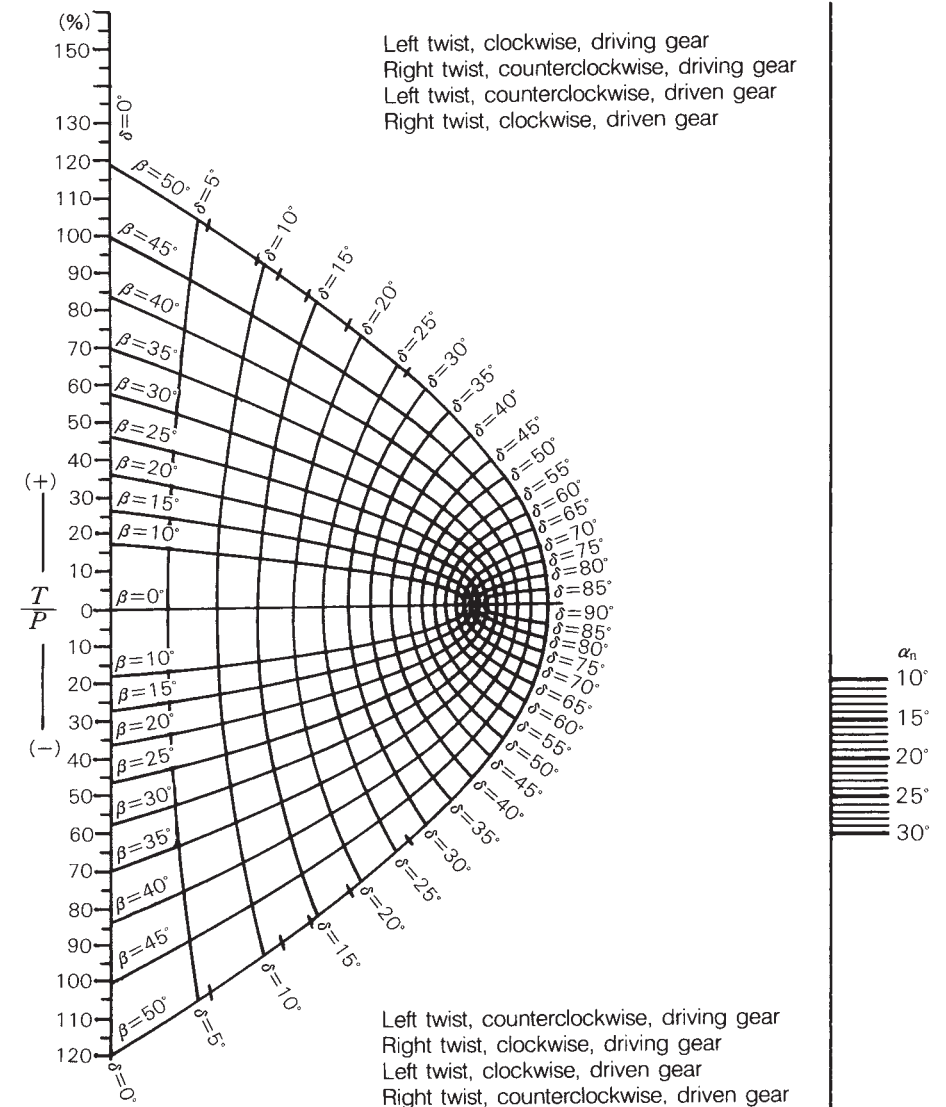

Calculation Diagram for Thrust T

(5) Calculation of Load on Worm Gears

A worm gear is a kind of spigot gear, which can produce a high reduction ratio with small volume. The load at the meshing point of worm gears is calculated as shown in Table 4.17. Variables used in Table 4.17 are as follows:

i : Gear ratio $\left(i = \frac{Z_2}{Z_w} \right)$

η : Worm gear efficiency $\left[\eta = \frac{\tan \gamma}{\tan(\gamma + \psi)} \right]$

γ : Advance angle $\left(\gamma = \tan^{-1} \frac{d_{p2}}{id_{p1}} \right)$

ψ : Frictional angle obtained from the following (as shown in Fig. 4.57):

$V_R = \frac{\pi d_{p1} n_1}{60} \times 10^{-3}$

When V_R is 0.2 m/s or less, $\psi = 8^\circ$.
When V_R exceeds 6 m/s, $\psi = 1^\circ 4'$.

- α_n : Gear normal pressure angle
- α_a : Shaft plane pressure angle
- Z_w : No. of threads (No. of worm gear teeth)
- Z_2 : No. of worm wheel teeth
- Subscript 1: For driving worm gear
- Subscript 2: For driven worm gear

In a worm gear, there are four combinations of interaction at the meshing point as shown below depending on the twist directions and rotating directions of the worm gear, as shown below.

The load on the bearing is obtained from the magnitude and direction of each component at the meshing point according to the method shown in Table 4.17.

Table 4.17 Gear Loads

Force	Worm	Worm Wheel
Tangential P	$\frac{9\,550\,000H}{n_1 \left(\frac{d_{p1}}{2}\right)} \dots\dots\dots(N)$	$\frac{9\,550\,000H\eta}{n_1 \left(\frac{d_{p2}}{2}\right)} = \frac{P_1 \eta}{\tan \gamma} = \frac{P_1}{\tan(\gamma + \psi)} \dots\dots\dots(N)$
	$\frac{974\,000H}{n_1 \left(\frac{d_{p1}}{2}\right)} \dots\dots\dots\{kgf\}$	$\frac{974\,000H\eta}{n_1 \left(\frac{d_{p2}}{2}\right)} = \frac{P_1 \eta}{\tan \gamma} = \frac{P_1}{\tan(\gamma + \psi)} \dots\dots\dots\{kgf\}$
Thrust T	$\frac{9\,550\,000H\eta}{n_1 \left(\frac{d_{p2}}{2}\right)} = \frac{P_1 \eta}{\tan \gamma} = \frac{P_1}{\tan(\gamma + \psi)} \dots\dots\dots(N)$	$\frac{9\,550\,000H}{n_1 \left(\frac{d_{p1}}{2}\right)} \dots\dots\dots(N)$
	$\frac{974\,000H\eta}{n_1 \left(\frac{d_{p2}}{2}\right)} = \frac{P_1 \eta}{\tan \gamma} = \frac{P_1}{\tan(\gamma + \psi)} \dots\dots\dots\{kgf\}$	$\frac{974\,000H}{n_1 \left(\frac{d_{p1}}{2}\right)} \dots\dots\dots\{kgf\}$
Separating S	$\frac{P_1 \tan \alpha_n}{\sin(\gamma + \psi)} = \frac{P_1 \tan \alpha_a}{\tan(\gamma + \psi)} \dots\dots\dots(N), \{kgf\}$	$\frac{P_1 \tan \alpha_n}{\sin(\gamma + \psi)} = \frac{P_1 \tan \alpha_a}{\tan(\gamma + \psi)} \dots\dots\dots(N), \{kgf\}$

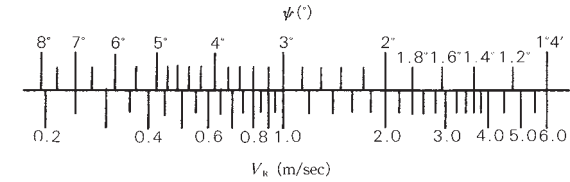

Fig. 4.57

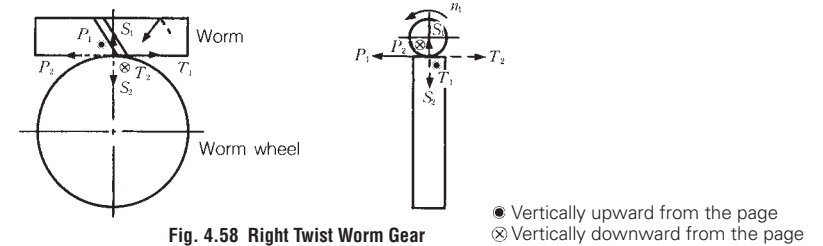

Fig. 4.58 Right Twist Worm Gear

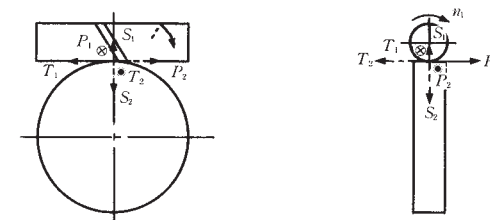

Fig. 4.59 Right Twist Worm Gear (Worm Rotation is Opposite Fig. 4.58)

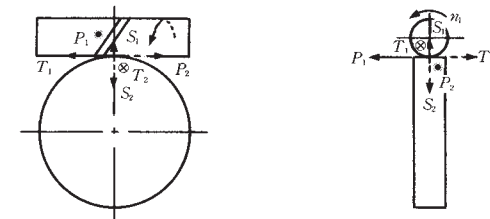

Fig. 4.60 Left Twist Worm Gear

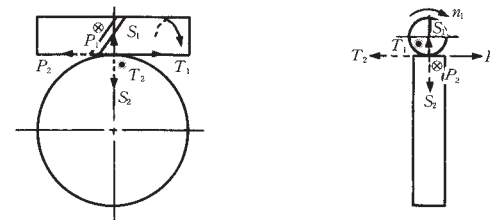
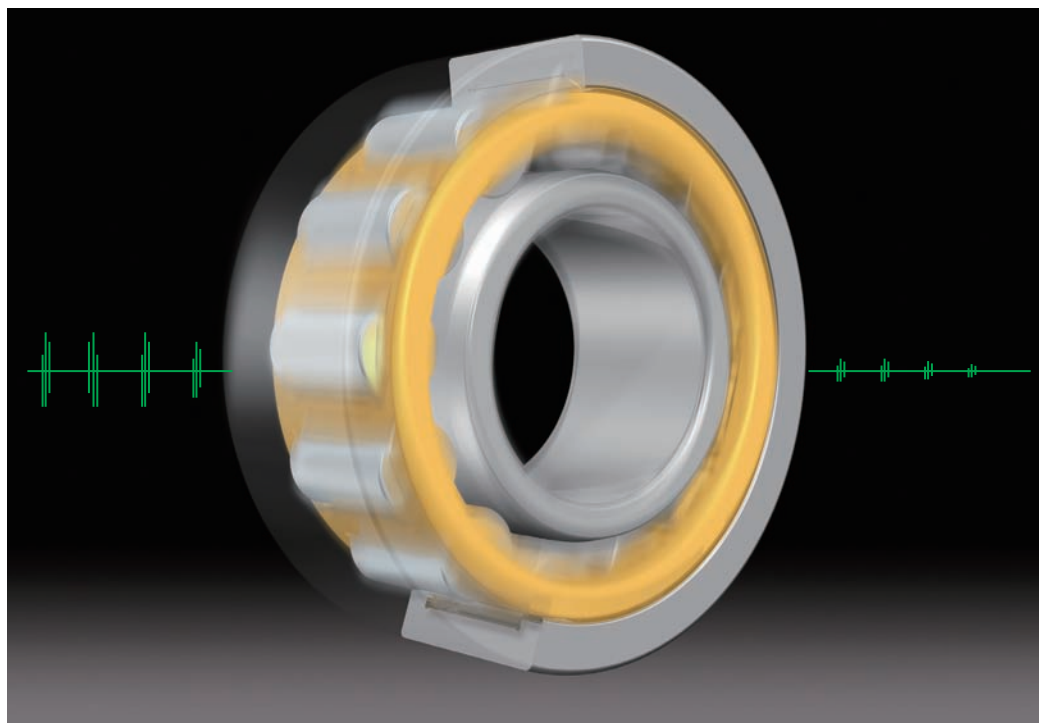

Fig. 4.61 Left Twist Worm Gear (Worm Rotation is Opposite Fig. 4.60)

5. SPEEDS

5.1 Limiting Speed (Grease/Oil)	A 098
5.1.1 Correction of Limiting Speed (Grease/Oil)	A 098
5.1.2 Limiting Speed (Grease/Oil) for Rubber Contact Seals in Ball Bearings	A 099
5.2 Thermal Reference Speed	A 099
5.3 Limiting Speed (Mechanical)	A 099
5.4 Technical Data	A 100
5.4.1 Rotation and Revolution Speed of Rolling Elements	A 100



5. SPEEDS

NSK uses four definitions of speed, as shown in Table 5.1.

Table 5.1 Overview of Speeds

Speed	Overview	Applicable Lubrication Methods
Limiting Speed (Grease)	Empirically obtained and comprehensive bearing limiting speed when using grease lubrication.	Grease lubrication
Limiting Speed (Oil)	Empirically obtained and comprehensive bearing limiting speed when using oil-bath lubrication.	Oil-bath lubrication
Thermal Reference Speed ⁽¹⁾	Rotational speed at which equilibrium is reached between the heat generated by the bearing and the heat flow emitted through the shaft and housing under reference conditions defined by ISO 15312. This is one among various criteria that shows suitability for high-speed operation.	Oil-bath lubrication subject to conditions outlined in ISO 15312
Limiting Speed (Mechanical) ⁽¹⁾	Mechanical and kinematic limiting speed achievable under ideal conditions for lubrication, heat dissipation, and temperature.	e.g. Properly designed and controlled forced-circulation oil lubrication

Note ⁽¹⁾ Thermal reference speeds and limiting speed (mechanical) are only listed in the tables for single-row cylindrical roller bearings and spherical roller bearings.

5.1 Limiting Speed (Grease/Oil)

When bearings are in operation, the higher the speed, the higher the bearing temperature due to friction. The limiting speed is the empirically obtained value for the maximum speed at which bearings can be continuously operated without generating excessive heat or failing due to seizure. Consequently, the limiting speed of bearings varies depending on such factors as bearing type and size, cage shape and material, load, lubricating method, and heat dissipation of the bearing's surroundings.

The limiting speed (grease) and limiting speed (oil) in the bearing tables are applicable to bearings of standard design subjected to normal loads, i.e. $C/P \geq 12$ and $F_a/F_r \leq$ approximately 0.2. The limiting speed (oil) listed in the bearing tables is for conventional oil-bath lubrication. Some types of lubricants are not suitable for high speed, even though they may be markedly superior in other respects. When speeds are more than 70 percent of the listed limiting speeds, be sure to select a grease or oil with good high speed characteristics.

Reference

- Table 11.2 Grease Properties (Pages A236 and 237)
- Table 11.5 Example Selection of Lubricant for Bearing Operating Conditions (Page A239)
- Table 11.6 Brands and Properties of Lubricating Grease (Pages A240 and A241)

5.1.1 Correction of Limiting Speed (Grease/Oil)

When bearing load P exceeds 8 % of the basic load rating C , or when the axial load F_a exceeds 20 % of the radial load F_r , the limiting speed (grease) and limiting speed (oil) must be corrected by multiplying the value found in the bearing tables by the correction factor shown in Figs. 5.1 and 5.2.

When the required speed exceeds the limiting speed (oil) of the desired bearing, then the accuracy grade, internal clearance, cage type and material, lubrication, etc. must be carefully studied in order to select a

bearing capable of the required speed. In such a case, forced-circulation oil lubrication, jet lubrication, oil-mist lubrication, or oil-air lubrication must be used. If all these conditions are considered, a corrected maximum permissible speed may be obtained by multiplying the limiting speed (oil) found in the bearing tables by the correction factor shown in table 5.2. Please consult with NSK regarding high-speed applications.

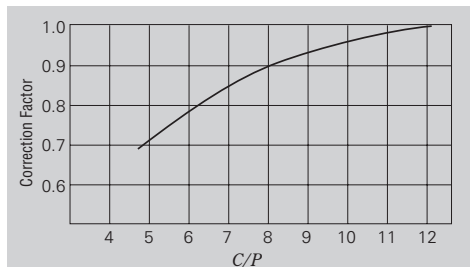

Fig. 5.1 Limiting Speed Correction Factor Variation With Load Ratio

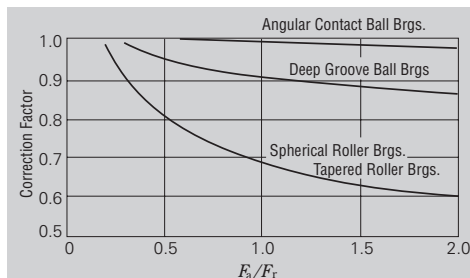

Fig. 5.2 Limiting Speed Correction Factor for Combined Radial and Axial Loads

Table 5.2 Limiting Speed Correction Factor for High-Speed Applications

Bearing Types	Correction Factor
Needle Roller Brgs.(except broad width)	2
Tapered Roller Brgs.	2
Deep Groove Ball Brgs.	2.5
Angular Contact Ball Brgs.(except matched bearings)	1.5

5.1.2 Limiting Speed (Grease/Oil) for Rubber Contact Seals in Ball Bearings

The maximum permissible speed for rubber contact sealed bearings (DDU type) is determined mainly by the sliding surface speed of the inner circumference of the seal. Values for the limiting speed are listed in the bearing tables.

5.2 Thermal Reference Speed

The thermal reference speed is the rotational speed at which equilibrium is reached between the heat generated by the bearing and the heat flow emitted through the shaft and housing under reference conditions defined by ISO 15312. This is one among various criteria that shows suitability for operation at high speed.

The reference conditions below are defined by ISO 15312:

- Outer ring: fixed, inner ring: rotating
- Mean ambient temperature: 20 °C
- Mean bearing temperature on outer ring: 70 °C
- Load on radial bearings: 0.05 C_{or}
- Lubrication: oil bath
- Lubricant: ISO VG32 (radial bearings)
- Normal bearing internal clearance

The amount of heat dissipated through the housing and shaft can be obtained from Fig.5.3. In the figure, A_r (mm^2) refers to the reference heat emission surface area. ISO defines A_r as the total area of the bearing's inner ring bore surface and outer ring outside surface (for radial bearings) and q_r (W/mm^2) as the heat flow density. Heat dissipation is calculated by multiplying this surface area (A_r) by the heat flow density (q_r).

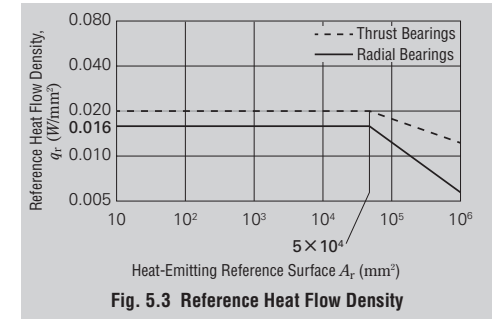

Fig. 5.3 Reference Heat Flow Density

5.3 Limiting Speed (Mechanical)

Limiting speed (mechanical) refers to the mechanical and kinematic limiting speed of bearings achievable under ideal lubrication, heat dissipation and temperature conditions, such as with properly designed and controlled forced-circulation oil lubrication for high-speed conditions.

The limiting speed (mechanical) considers the sliding speed and contact forces between the various bearing elements, the centrifugal and gyratory forces, etc. The values in the tables are applicable to standard bearings subjected to normal loads ($C/P =$ approximately 12).

In the bearing tables for single-row cylindrical roller bearings and spherical roller bearings, the thermal reference speeds, limiting speeds (mechanical) and limiting speeds (grease) are listed. In the bearing tables for other bearing types, limiting speeds (grease) and limiting speeds (oil) are listed.

5.4 Technical Data

5.4.1 Rotation and Revolution Speed of Rolling Elements

When the rolling element rotates without slippage between the bearing rings, the distance the rolling element rolls on the inner ring raceway is equal to that on the outer ring raceway. This allows for a relationship between inner and outer ring speeds n_i and n_e and rolling element rotations n_a .

The revolution speed of the rolling element can be determined as the arithmetic mean of the circumferential speed on the inner ring raceway and that on the outer ring raceway (generally with either a stationary inner or outer ring). The rotations and revolutions of the rolling elements can be related as expressed by Equations (5.1) through (5.4).

No. of rotations

$$n_a = \left(\frac{D_{pw}}{D_w} - \frac{D_w \cos^2 \alpha}{D_{pw}} \right) \frac{n_e - n_i}{2} \quad (\text{min}^{-1}) \dots\dots\dots (5.1)$$

Rotational circumferential speed

$$v_a = \frac{\pi D_w}{60 \times 10^3} \left(\frac{D_{pw}}{D_w} - \frac{D_w \cos^2 \alpha}{D_{pw}} \right) \frac{n_e - n_i}{2} \quad (\text{m/s}) \dots\dots\dots (5.2)$$

No. of revolutions (No. of cage rotations)

$$n_c = \left(1 - \frac{D_w \cos \alpha}{D_{pw}} \right) \frac{n_i}{2} + \left(1 + \frac{D_w \cos \alpha}{D_{pw}} \right) \frac{n_e}{2} \quad (\text{min}^{-1}) \dots\dots\dots (5.3)$$

Revolutions circumferential speed (cage speed at rolling element pitch diameter)

$$v_c = \frac{\pi D_{pw}}{60 \times 10^3} \left[\left(1 - \frac{D_w \cos \alpha}{D_{pw}} \right) \frac{n_i}{2} + \left(1 + \frac{D_w \cos \alpha}{D_{pw}} \right) \frac{n_e}{2} \right] (\text{m/s}) \dots\dots\dots (5.4)$$

where D_{pw} : Pitch diameter of rolling elements (mm)
 D_w : Diameter of rolling element (mm)
 α : Contact angle ($^\circ$)
 n_e : Outer ring speed (min^{-1})
 n_i : Inner ring speed (min^{-1})

Rotations and revolutions of the rolling elements are shown in Table 5.3 for inner ring rotating ($n_e = 0$) and outer ring rotating ($n_i = 0$) respectively at $0^\circ \leq \alpha < 90^\circ$ and at $\alpha = 90^\circ$.

Table 5.4 shows the rotation speed n_a and revolution speed n_c of the rolling elements during inner ring rotation of ball bearings 6210 and 6310.

Table 5.4 Rolling Element Rotation Speed n_a and Revolution Speed n_c for Ball Bearings 6210 and 6310

Ball Bearing	γ	n_a	n_c
6210	0.181	$-2.67n_i$	$0.41n_i$
6310	0.232	$-2.04n_i$	$0.38n_i$

Remarks $\gamma = \frac{D_w \cos \alpha}{D_{pw}}$

Table 5.3 Rolling Element Rotation Speed n_a , Rotational Circumferential Speed v_a , Revolution Speed n_c , and Revolutions Circumferential Speed v_c

Contact Angle	Rotation/Revolution Speed	Inner Ring Rotation ($n_e = 0$)	Outer Ring Rotation ($n_i = 0$)
$0^\circ \leq \alpha < 90^\circ$	n_a (min^{-1})	$-\left(\frac{1}{\gamma} - \gamma\right) \frac{n_i}{2} \cdot \cos \alpha$	$\left(\frac{1}{\gamma} - \gamma\right) \frac{n_e}{2} \cdot \cos \alpha$
	v_a (m/s)	$\frac{\pi D_w}{60 \times 10^3} n_a$	
	n_c (min^{-1})	$(1 - \gamma) \frac{n_i}{2}$	$(1 + \gamma) \frac{n_e}{2}$
	v_c (m/s)	$\frac{\pi D_{pw}}{60 \times 10^3} n_c$	
$\alpha = 90^\circ$	n_a (min^{-1})	$-\frac{1}{\gamma} \cdot \frac{n_i}{2}$	$\frac{1}{\gamma} \cdot \frac{n_e}{2}$
	v_a (m/s)	$\frac{\pi D_w}{60 \times 10^3} n_a$	
	n_c (min^{-1})	$\frac{n_i}{2}$	$\frac{n_e}{2}$
	v_c (m/s)	$\frac{\pi D_{pw}}{60 \times 10^3} n_c$	

Reference 1. \pm : "+" indicates clockwise rotation while "-" indicates counterclockwise rotation.

2. $\gamma = \frac{D_w \cos \alpha}{D_{pw}}$ ($0^\circ \leq \alpha < 90^\circ$), $\gamma = -\frac{D_w}{D_{pw}}$ ($\alpha = 90^\circ$)

6. BOUNDARY DIMENSIONS AND BEARING DESIGNATIONS

6.1	Boundary Dimensions and Dimensions of Snap Ring Grooves	A 104
6.1.1	Boundary Dimensions	A 104
6.1.2	Dimensions of Snap Ring Grooves and Locating Snap Rings	A 104
6.2	Formulation of Bearing Designations	A 120



6. BOUNDARY DIMENSIONS AND BEARING DESIGNATIONS

6.1 Boundary Dimensions and Dimensions of Snap Ring Grooves

6.1.1 Boundary Dimensions

The boundary dimensions of rolling bearings, which are shown in Figs.6.1 through 6.5, refer to the dimensions that define their external geometry. They include bore diameter d , outside diameter D , width B , assembled bearing width(or height) T , chamfer dimension r , etc. All of these dimensions are important when mounting a bearing on a shaft and in a housing. These boundary dimensions have been internationally standardized (ISO15) and adopted by JIS B 1512 (*Boundary Dimensions of Rolling Bearings*).

The boundary dimensions and Dimension Series of radial bearings, tapered roller bearings, and thrust bearings are listed in Tables 6.1 to 6.3 (Pages A106 to A115).

These tables list boundary dimensions for each Diameter and Dimension Series by bore number. A very large number of series are possible; however, not all are currently commercially available. Representative bearing types and series designations are shown across the top of the bearing tables (refer to Table 6.5, Bearing Series Designations on Page A121 for more information).

The relative cross-sectional dimensions of radial bearings (excluding tapered roller bearings) and thrust bearings for various series are shown in Figs. 6.6 and 6.7 respectively.

6.1.2 Dimensions of Snap Ring Grooves and Locating Snap Rings

The dimensions of snap ring grooves in the outer surfaces of bearings and the dimensions and accuracy of the locating snap rings themselves are specified by ISO 464. The dimensions of snap ring grooves and locating snap ring for bearings of Diameter Series 8, 9, 0, 2, 3, and 4 are shown in Table 6.4 (Pages A116 to A119).

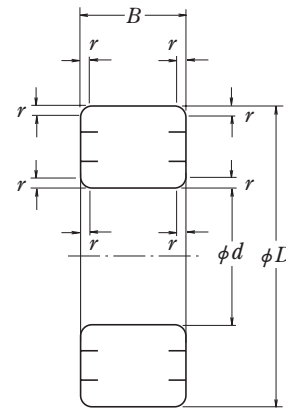

Fig. 6.1 Boundary Dimensions of Radial Ball and Roller Bearings

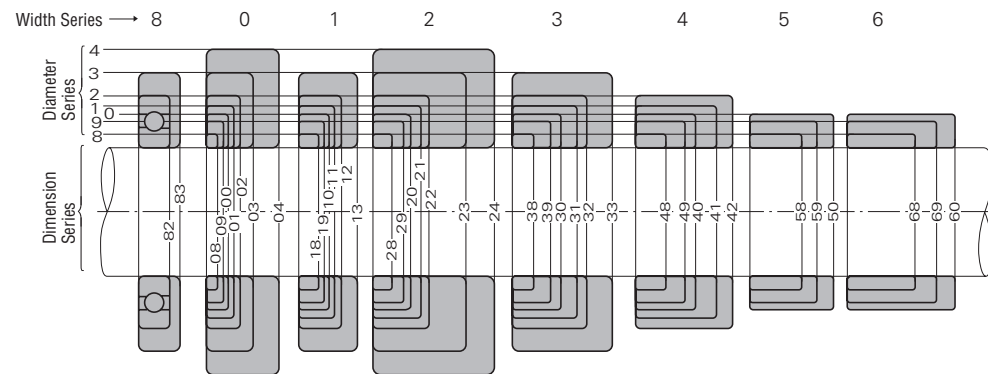

Fig. 6.6 Comparison of Cross Sections of Radial Bearings (Excluding Tapered Roller Bearings) for Various Dimensional Series

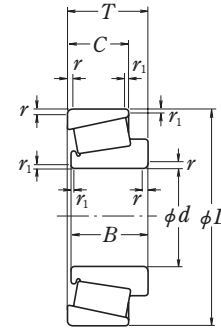

Fig. 6.2 Tapered Roller Bearings

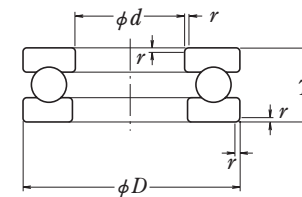

Fig. 6.3 Single-Direction Thrust Ball Bearings

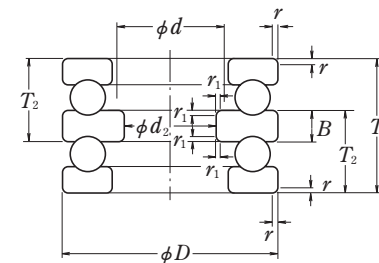

Fig. 6.4 Double-Direction Thrust Ball Bearings

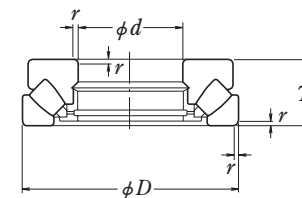

Fig. 6.5 Spherical Thrust Roller Bearings

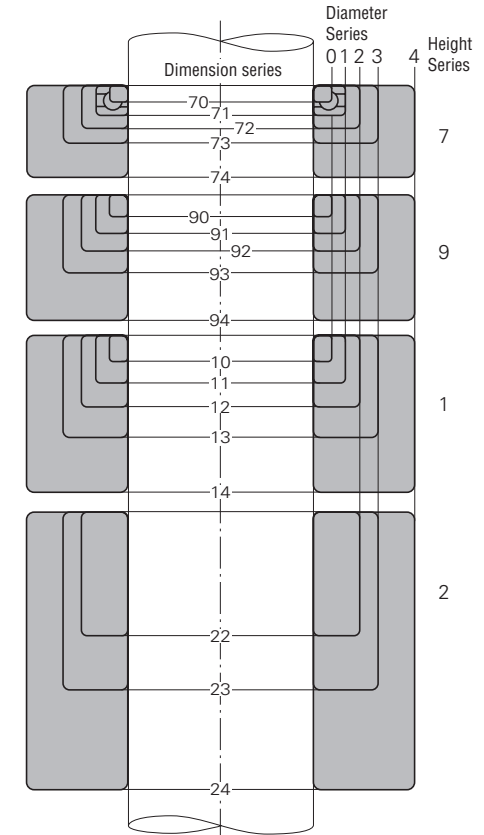

Fig. 6.7 Comparison of Cross Sections of Thrust Bearings (Excluding Diameter Series 5) for Various Dimension Series

Table 6. 1 Boundary Dimensions of Radial Bearings (Excluding Tapered Roller Bearings) — (2)

Bore Number	d	Diameter Series 1												Diameter Series 2												Diameter Series 3												Diameter Series 4			
		Dimension Series				Dimension Series				Dimension Series				Dimension Series				Dimension Series				Dimension Series				Dimension Series															
		B				B				B				B				B				B				B															
		01	11	21	31	41	01	11	21	31	41	01	11	21	31	41	01	11	21	31	41	01	11	21	31	41	01	11	21	31	41	04	24	r (min.)	r (min.)						
1	105	175	22	33	42	56	69	80	1.1	2	2	2	2	2	190	27	36	40	42	85	1.5	2.1	2.1	2.1	2.1	225	37	49	53	77	87.3	2.1	4								
2	110	180	22	33	42	56	69	80	1.5	2	2	2	2	200	28	38	42	44	90	1.5	2.1	2.1	2.1	2.1	240	42	50	57	80	92.1	3	4									
3	120	200	25	38	48	62	80	100	2	2	2	2	2	230	40	46	50	52	100	3	3	3	3	3	300	48	55	62	86	106	3	5									
4	130	210	25	38	48	62	80	100	2	2	2	2	2	270	45	54	58	60	118	3	3	3	3	3	320	50	58	66	92	112	4	5									
5	140	225	27	40	50	66	85	110	2.1	2.1	2.1	2.1	2.1	290	48	58	62	64	128	3	3	3	3	3	360	55	64	72	100	128	4	5									
6	150	250	31	46	56	74	95	125	2.1	2.1	2.1	2.1	2.1	310	52	62	66	68	140	4	4	4	4	4	400	60	70	78	108	140	4	5									
7	160	270	34	51	62	82	104	138	2.1	2.1	2.1	2.1	2.1	340	55	65	70	72	150	4	4	4	4	4	440	66	76	84	114	150	5	6									
8	170	280	34	51	62	82	104	138	2.1	2.1	2.1	2.1	2.1	360	58	68	73	75	160	4	4	4	4	4	480	70	80	88	120	160	5	6									
9	180	300	37	54	66	86	110	144	2.1	2.1	2.1	2.1	2.1	400	65	75	80	82	180	4	4	4	4	4	540	78	88	96	132	180	5	6									
10	190	320	42	60	72	92	118	150	3	3	3	3	3	440	72	82	87	89	200	4	4	4	4	4	600	84	94	102	144	200	6	7									
11	200	340	44	63	76	96	122	156	3	3	3	3	3	480	78	88	93	95	220	4	4	4	4	4	660	90	100	108	156	220	6	7									
12	210	360	48	66	80	100	130	162	3	3	3	3	3	500	82	92	97	99	240	4	4	4	4	4	700	96	106	114	162	240	6	7									
13	220	370	48	66	80	100	130	162	3	3	3	3	3	540	88	98	103	105	260	4	4	4	4	4	780	102	112	120	174	260	6	7									
14	230	380	48	66	80	100	130	162	3	3	3	3	3	580	92	102	107	109	280	4	4	4	4	4	840	108	118	126	180	280	6	7									
15	240	400	50	69	84	104	134	168	3	3	3	3	3	620	95	105	110	112	300	4	4	4	4	4	900	114	124	132	192	300	6	7									
16	250	420	52	72	88	108	140	174	3	3	3	3	3	660	99	109	114	116	320	4	4	4	4	4	960	120	130	138	204	320	6	7									
17	260	440	54	75	92	112	144	180	3	3	3	3	3	700	102	112	117	119	340	4	4	4	4	4	1000	126	136	144	210	340	6	7									
18	270	460	56	78	96	116	148	186	3	3	3	3	3	740	105	115	120	122	360	4	4	4	4	4	1060	132	142	150	216	360	6	7									
19	280	480	58	81	98	118	152	192	3	3	3	3	3	780	108	118	123	125	380	4	4	4	4	4	1120	138	148	156	222	380	6	7									
20	290	500	60	84	102	122	156	198	3	3	3	3	3	820	111	121	126	128	400	4	4	4	4	4	1180	144	154	162	228	400	6	7									
21	300	520	62	87	106	126	160	204	3	3	3	3	3	860	114	124	129	131	420	4	4	4	4	4	1240	150	160	168	234	420	6	7									
22	310	540	64	90	110	130	164	210	3	3	3	3	3	900	117	127	132	134	440	4	4	4	4	4	1300	156	166	174	240	440	6	7									
23	320	560	66	93	114	134	168	216	3	3	3	3	3	940	120	130	135	137	460	4	4	4	4	4	1360	162	172	180	246	460	6	7									
24	330	580	68	96	118	138	172	222	3	3	3	3	3	980	123	133	138	140	480	4	4	4	4	4	1420	168	178	186	252	480	6	7									
25	340	600	70	99	122	142	176	228	3	3	3	3	3	1020	126	136	141	143	500	4	4	4	4	4	1480	174	184	192	258	500	6	7									
26	350	620	72	102	126	146	180	234	3	3	3	3	3	1060	129	139	144	146	520	4	4	4	4	4	1540	180	190	198	264	520	6	7									
27	360	640	74	105	130	150	184	240	3	3	3	3	3	1100	132	142	147	149	540	4	4	4	4	4	1600	186	196	204	270	540	6	7									
28	370	660	76	108	134	154	188	246	3	3	3	3	3	1140	135	145	150	152	560	4	4	4	4	4	1660	192	202	210	276	560	6	7									
29	380	680	78	111	138	158	192	252	3	3	3	3	3	1180	138	148	153	155	580	4	4	4	4	4	1720	198	208	216	282	580	6	7									
30	390	700	80	114	142	162	196	258	3	3	3	3	3	1220	141	151	156	158	600	4	4	4	4	4	1780	204	214	222	288	600	6	7									
31	400	720	82	117	146	166	200	264	3	3	3	3	3	1260	144	154	159	161	620	4	4	4	4	4	1840	210	220	228	294	620	6	7									
32	410	740	84	120	150	170	204	270	3	3	3	3	3	1300	147	157	162	164	640	4	4	4	4	4	1900	216	226	234	300	640	6	7									
33	420	760	86	123	154	174	208	276	3	3	3	3	3	1340	150	160	165	167	660	4	4	4	4	4	1960	222	232	240	306	660	6	7									
34	430	780	88	126	158	178	212	282	3	3	3	3	3	1380	153	163	168	170	680	4	4	4	4	4	2020	228	238	246	312	680	6	7									
35	440	800	90	129	162	182	216	288	3	3	3	3	3	1420	156	166	171	173	700	4	4	4	4	4	2080	234	244	252	318	700	6	7									
36	450	820	92	132	166	186	220	294	3	3	3	3	3	1460	159	169	174	176	720	4	4	4	4	4	2140	240	250	258	324	720	6	7									
37	460	840	94	135	170	190	224	300	3	3	3	3	3	1500	162	172	177	179	740	4	4	4	4	4	2200	246	256	264	330	740	6	7									
38	470	860	96	138	174	194	228	306	3	3	3	3	3	1540	165	175	180	182	760	4	4	4	4	4	2260	252	262	270	336	760	6	7									
39	480	880	98	141	178	198	232	312	3	3	3	3	3	1580	168	178	183	185	780	4	4	4	4	4	2320	258	268	276	342	780	6	7									
40	490	900	100	144	182	202	236	318	3	3	3	3	3	1620	171	181	186	188	800	4	4	4	4	4	2380	264	274	282	348	800	6	7									
41	500	920	102	147	186	206	240	324	3	3	3	3	3	1660	174	184	189	191	820	4	4	4	4	4	2440	270	280	288	354	820	6	7									
42	510	940	104	150	190	210	244	330	3	3	3	3	3	1700	177	187	192	194	840	4	4	4	4	4	2500	276	286	294	360	840	6	7									
43	520	960	106	153	194	214	248	336	3	3	3	3	3	1740	180	190	195	197	860	4	4	4	4	4	2560	282	292	300	366	860	6	7									
44	530	980	108	156	198	218	252	342	3	3	3	3	3	1780	183	193	198	200	880	4	4	4	4	4	2620	288	298	306	372	880	6	7									
45	540	1000	110	159	202	222	256	348	3	3	3	3	3	1820	186	196	201	203	900	4	4	4	4	4	2680	294	304	312	378	900	6	7									
46	550	1020	112	162	206	226	260	354	3	3	3	3	3	1860	189	199	204	206	920	4	4	4	4	4	2740	300	310	318	384	920	6	7									
47	560	1040	114	165	210	230	264	360	3	3	3	3	3	1900	192	202	207	209	940	4	4	4	4	4	2800	306	316	324	390	940	6	7									
48	570	1060	116	168	214	234	268	366	3	3	3	3	3	1940	195	205	210	212	960	4	4	4	4	4	2860	312	3														

Table 6. 2 Boundary Dimensions of

Tapered Roller Bearings	329										320 X			330			331								
	Bore Number	Diameter Series 9										Diameter Series 0						Diameter Series 1							
		d	Dimension Series 29						Chamfer Dimension		Dimension Series 20			Dimension Series 30			Chamfer Dimension		Dimension Series 31		Chamfer Dimension				
			D	B	C	T	B	C	T	r (min.)	O.R.	B	C	T	B	C	T	r (min.)	O.R.	B	C	T	r (min.)	O.R.	
00	10	—	—	—	—	—	—	—	—	—	—	—	—	—	—	—	—	—	—	—	—	—	—		
01	12	—	—	—	—	—	—	—	—	—	—	—	—	—	—	—	—	—	—	—	—	—	—		
02	15	—	—	—	—	—	—	—	—	—	—	—	—	—	—	—	—	—	—	—	—	—	—		
03	17	—	—	—	—	—	—	—	—	—	—	—	—	—	—	—	—	—	—	—	—	—	—		
04	20	37	11	—	11.6	12	9	12	0.3	0.3	42	15	12	15	17	—	17	0.6	0.6	—	—	—	—		
22	22	40	—	—	12	9	12	0.3	0.3	44	15	11.5	15	—	—	—	—	0.6	0.6	—	—	—	—		
05	25	42	11	—	11.6	12	9	12	0.3	0.3	47	15	11.5	15	17	14	17	0.6	0.6	—	—	—	—		
28	28	45	—	—	12	9	12	0.3	0.3	52	16	12	16	—	—	—	—	1	1	—	—	—	—		
06	30	47	11	—	11.6	12	9	12	0.3	0.3	55	17	13	17	20	16	20	1	1	—	—	—	—		
32	32	52	—	—	15	10	14	0.6	0.6	58	17	13	17	—	—	—	—	1	1	—	—	—	—		
35	35	55	13	—	14	14	11.5	14	0.6	0.6	62	18	14	18	21	17	21	1	1	—	—	—	—		
07	40	62	14	—	15	12	15	0.6	0.6	68	19	14.5	19	22	18	22	1	1	75	26	20.5	26	1.5	1.5	
09	45	68	14	—	15	12	15	0.6	0.6	75	20	15.5	20	24	19	24	1	1	80	26	20.5	26	1.5	1.5	
10	50	72	14	—	15	12	15	0.6	0.6	80	20	15.5	20	24	19	24	1	1	85	26	20	26	1.5	1.5	
11	55	80	16	—	17	17	14	1	1	90	23	17.5	23	27	21	27	1.5	1.5	95	30	23	30	1.5	1.5	
12	60	85	16	—	17	17	14	1	1	95	23	17.5	23	27	21	27	1.5	1.5	100	30	23	30	1.5	1.5	
13	65	90	16	—	17	17	14	1	1	100	23	17.5	23	27	21	27	1.5	1.5	110	34	26.5	34	1.5	1.5	
14	70	100	19	—	20	20	16	20	1	1	110	25	19	25	31	25.5	31	1.5	1.5	120	37	29	37	2	1.5
15	75	105	19	—	20	20	16	20	1	1	115	25	19	25	31	25.5	31	1.5	1.5	125	37	29	37	2	1.5
16	80	110	19	—	20	20	16	20	1	1	125	29	22	29	36	29.5	36	1.5	1.5	130	37	29	37	2	1.5
17	85	120	22	—	23	23	18	23	1.5	1.5	130	29	22	29	36	29.5	36	1.5	1.5	140	41	32	41	2.5	2
18	90	125	22	—	23	23	18	23	1.5	1.5	140	32	24	32	39	32.5	39	2	1.5	150	45	35	45	2.5	2
19	95	130	22	—	23	23	18	23	1.5	1.5	145	32	24	32	39	32.5	39	2	1.5	160	49	38	49	2.5	2
20	100	140	24	—	25	25	20	25	1.5	1.5	150	32	24	32	39	32.5	39	2	1.5	165	52	40	52	2.5	2
21	105	145	24	—	25	25	20	25	1.5	1.5	160	35	26	35	43	34	43	2.5	2	175	56	44	56	2.5	2
22	110	150	24	—	25	25	20	25	1.5	1.5	170	38	29	38	47	37	47	2.5	2	180	56	43	56	2.5	2
24	120	165	27	—	29	29	23	29	1.5	1.5	180	38	29	38	48	38	48	2.5	2	200	62	48	62	2.5	2
26	130	180	30	—	32	32	25	32	2	1.5	200	45	34	45	55	43	55	2.5	2	—	—	—	—	—	—
28	140	190	30	—	32	32	25	32	2	1.5	210	45	34	45	56	44	56	2.5	2	—	—	—	—	—	—
30	150	210	36	—	38	38	30	38	2.5	2	225	48	36	48	59	46	59	3	2.5	—	—	—	—	—	—
32	160	220	36	—	38	38	30	38	2.5	2	240	51	38	51	—	—	—	3	2.5	—	—	—	—	—	—
34	170	230	36	—	38	38	30	38	2.5	2	260	57	43	57	—	—	—	3	2.5	—	—	—	—	—	—
36	180	250	42	—	45	45	34	45	2.5	2	280	64	48	64	—	—	—	3	2.5	—	—	—	—	—	—
38	190	260	42	—	45	45	34	45	2.5	2	290	64	48	64	—	—	—	3	2.5	—	—	—	—	—	—
40	200	280	48	—	51	51	39	51	3	2.5	310	70	53	70	—	—	—	3	2.5	—	—	—	—	—	—
44	220	300	48	—	51	51	39	51	3	2.5	340	76	57	76	—	—	—	4	3	—	—	—	—	—	—
48	240	320	48	—	51	51	39	51	3	2.5	360	76	57	76	—	—	—	4	3	—	—	—	—	—	—
52	260	360	—	—	63.5	63.5	48	63.5	3	2.5	400	87	65	87	—	—	—	5	4	—	—	—	—	—	—
56	280	380	—	—	63.5	63.5	48	63.5	3	2.5	420	87	65	87	—	—	—	5	4	—	—	—	—	—	—
60	300	420	—	—	76	76	57	76	4	3	460	100	74	100	—	—	—	5	4	—	—	—	—	—	—
64	320	440	—	—	76	76	57	76	4	3	480	100	74	100	—	—	—	5	4	—	—	—	—	—	—
68	340	460	—	—	76	76	57	76	4	3	—	—	—	—	—	—	—	—	—	—	—	—	—	—	—
72	360	480	—	—	76	76	57	76	4	3	—	—	—	—	—	—	—	—	—	—	—	—	—	—	—

Remarks 1. Other Series not conforming to this table are also specified by ISO.
 2. In Diameter Series 9, Classification I refers to specifications of the old standard, while Classification II refers to those specified by ISO. Dimension Series without classifications conform to dimensions (D, B, C, T) specified by ISO.
 3. The chamfer dimensions listed are the minimum permissible dimensions specified by ISO. They do not apply to chamfers on the front face.

Tapered Roller Bearings

Units: mm

Tapered Roller Bearings	302										322			332				303 or 303D				313			323				Bore Number
	Diameter Series 2										Diameter Series 3																		
	D	Series 02			Series 22			Series 32			Chamfer Dimension		Dimension Series 03				Series 13			Series 23			Chamfer Dimension						
		B	C	T	B	C	T	B	C	T	r (min.)	O.R.	B	C	C ⁽¹⁾	T	B	C	T	B	C	T	r (min.)	O.R.					
30		9	—	9.7	14	—	14.7	—	—	—	0.6	0.6	35	11	—	—	11.9	—	—	—	—	17.9	0.6	0.6	10	00			
32	10	9	10.75	14	—	14.75	—	—	—	0.6	0.6	37	12	—	—	12.9	—	—	—	—	17.9	1	1	12	01				
01	12	—	—	—	—	—	—	—	—	—	—	42	13	11	—	14.25	—	—	—	—	17	14	18.25	1	1				
02	15	—	—	—	—	—	—	—	—	—	—	42	13	11	—	14.25	—	—	—	—	17	14	18.25	1	1				
03	17	—	—	—	—	—	—	—	—	—	—	47	14	12	—	15.25	—	—	—	—	19	16	20.25	1	1				
04	20	37	11	—	11.6	12	9	12	0.3	0.3	42	15	12	15	17	—	—	—	—	21	18	22.25	1.5	1.5					
22	22	40	—	—	12	9	12	0.3	0.3	44	15	11.5	15	—	—	—	—	—	—	21	18	22.25	1.5	1.5					
05	25	42	11	—	11.6	12	9	12	0.3	0.3	47	15	11.5	15	17	14	17	0.6	0.6	—	—	—	—	—	—				
28	28	45	—	—	12	9	12	0.3	0.3	52	16	12	16	—	—	—	—	—	—	24	20	25.25	1.5	1.5					
06	30	47	11	—	11.6	12	9	12	0.3	0.3	55	17	13	17	20	16	20	1	1	—	—	—	—	—	—				
32	32	52	—	—	15	10	14	0.6	0.6	58	17	13	17	—	—	—	—	—	—	28	24	29.75	1.5	1.5					
35	35	55	13	—	14	14	11.5	14	0.6	0.6	62	18	14	18	21	17	21	1	1	—	—	—	—	—	—				
07	40	62	14	—	15	12	15	0.6	0.6	68	19	14.5	19	22	18	22	1	1	75	26	20.5	26	1.5	1.5					
09	45	68	14	—	15	12	15	0.6	0.6	75	20	15.5	20	24	19	24	1	1	80	26	20.5	26	1.5	1.5					
10	50	72	14	—	15	12	15	0.6	0.6	80	20	15.5	20	24	19	24	1	1	85	26	20	26	1.5	1.5					
11	55	80	16	—	17	17	14	1	1	90	23	17.5	23	27	21	27	1.5	1.5	95	30	23	30	1.5	1.5					
12	60	85	16	—	17	17	14	1	1	95	23	17.5	23	27	21	27	1.5	1.5	100	30	23	30	1.5	1.5					
13	65	90	16	—	17	17	14	1	1	100	23	17.5	23	27	21	27	1.5	1.5	110	34	26.5	34	1.5	1.5					
14	70	100	19	—	20	20	16	20	1	1	110	25	19	25	3														

Table 6.3 Boundary Dimensions of

Thrust Ball Brgs. Spherical Thrust Roller Brgs.	511										512			522						
											292									
	Bore Number	d	Diameter Series 0					Diameter Series 1					Diameter Series 2							
			Dimension Series			r ₁ (min.)	D	Dimension Series			r ₁ (min.)	D	Dimension Series				r ₁ (min.)	r ₁ (min.)		
70			90	10	71			91	11	72			92	12	22	22				
T			T			T				Central Washer										
										d ₂	B									
68	340	380	18	24	30	1	420	36	48	64	2	460	54	73	96	—	—	—	3	—
72	360	400	18	24	30	1	440	36	48	65	2	500	63	85	110	—	—	—	4	—
76	380	420	18	24	30	1	460	36	48	65	2	520	63	85	112	—	—	—	4	—
80	400	440	18	24	30	1	480	36	48	65	2	540	63	85	112	—	—	—	4	—
84	420	460	18	24	30	1	500	36	48	65	2	580	73	95	130	—	—	—	5	—
88	440	480	18	24	30	1	540	45	60	80	2.1	600	73	95	130	—	—	—	5	—
92	460	500	18	24	30	1	560	45	60	80	2.1	620	73	95	130	—	—	—	5	—
96	480	520	18	24	30	1	580	45	60	80	2.1	650	78	103	135	—	—	—	5	—
/500	500	540	18	24	30	1	600	45	60	80	2.1	670	78	103	135	—	—	—	5	—
/530	530	580	23	30	38	1.1	640	50	67	85	3	710	82	109	140	—	—	—	5	—
/560	560	610	23	30	38	1.1	670	50	67	85	3	750	85	115	150	—	—	—	5	—
/600	600	650	23	30	38	1.1	710	50	67	85	3	800	90	122	160	—	—	—	5	—
/630	630	680	23	30	38	1.1	750	54	73	95	3	850	100	132	175	—	—	—	6	—
/670	670	730	27	36	45	1.5	800	58	78	105	4	900	103	140	180	—	—	—	6	—
/710	710	780	32	42	53	1.5	850	63	85	112	4	950	109	145	190	—	—	—	6	—
/750	750	820	32	42	53	1.5	900	67	90	120	4	1000	112	150	195	—	—	—	6	—
/800	800	870	32	42	53	1.5	950	67	90	120	4	1060	118	155	205	—	—	—	7.5	—
/850	850	920	32	42	53	1.5	1000	67	90	120	4	1120	122	160	212	—	—	—	7.5	—
/900	900	980	36	48	63	2	1060	73	95	130	5	1180	125	170	220	—	—	—	7.5	—
/950	950	1030	36	48	63	2	1120	78	103	135	5	1250	136	180	236	—	—	—	7.5	—
/1000	1000	1090	41	54	70	2.1	1180	82	109	140	5	1320	145	190	250	—	—	—	9.5	—
/1060	1060	1150	41	54	70	2.1	1250	85	115	150	5	1400	155	206	265	—	—	—	9.5	—
/1120	1120	1220	45	60	80	2.1	1320	90	122	160	5	1460	—	206	—	—	—	—	9.5	—
/1180	1180	1280	45	60	80	2.1	1400	100	132	175	6	1520	—	206	—	—	—	—	9.5	—
/1250	1250	1360	50	67	85	3	1460	—	—	175	6	1610	—	216	—	—	—	—	9.5	—
/1320	1320	1440	—	—	95	3	1540	—	—	175	6	1700	—	228	—	—	—	—	9.5	—
/1400	1400	1520	—	—	95	3	1630	—	—	180	6	1790	—	234	—	—	—	—	12	—
/1500	1500	1630	—	—	105	4	1750	—	—	195	6	1920	—	252	—	—	—	—	12	—
/1600	1600	1730	—	—	105	4	1850	—	—	195	6	2040	—	264	—	—	—	—	15	—
/1700	1700	1840	—	—	112	4	1970	—	—	212	7.5	2160	—	276	—	—	—	—	15	—
/1800	1800	1950	—	—	120	4	2080	—	—	220	7.5	2280	—	288	—	—	—	—	15	—
/1900	1900	2060	—	—	130	5	2180	—	—	220	7.5	—	—	—	—	—	—	—	—	—
/2000	2000	2160	—	—	130	5	2300	—	—	236	7.5	—	—	—	—	—	—	—	—	—
/2120	2120	2300	—	—	140	5	2430	—	—	243	7.5	—	—	—	—	—	—	—	—	—
/2240	2240	2430	—	—	150	5	2570	—	—	258	9.5	—	—	—	—	—	—	—	—	—
/2360	2360	2550	—	—	150	5	2700	—	—	265	9.5	—	—	—	—	—	—	—	—	—
/2500	2500	2700	—	—	160	5	2850	—	—	272	9.5	—	—	—	—	—	—	—	—	—

Remarks 1. Dimension Series 22, 23, and 24 are double-direction bearings.
2. The maximum permissible outside diameter of shaft and central washers and minimum permissible bore diameter of housing washers are omitted here (refer to the bearings tables for thrust bearings).

Thrust Bearings (Flat Seats) — (2)

																		514						524			513			523			514			524			513			523		
																								294						293														
Bore Number	d	Diameter Series 3															Diameter Series 4						Diameter Series 5			Bore Number																		
		Dimension Series					r ₁ (min.)	r ₁ (min.)	Dimension Series					r ₁ (min.)	r ₁ (min.)	D	Dimension Series	r ₁ (min.)																										
		73	93	13	23	23			74	94	14	24	24						95																									
		T					Central Washer		T					Central Washer		T																												
					d ₂	B						d ₂	B																															
540	90	122	160	—	—	—	5	—	620	125	170	220	—	—	—	7.5	—	750	243	12	340	68																						
560	90	122	160	—	—	—	5	—	640	125	170	220	—	—	—	7.5	—	780	250	12	360	72																						
600	100	132	175	—	—	—	6	—	670	132	175	224	—	—	—	7.5	—	820	265	12	380	76																						
620	100	132	175	—	—	—	6	—	710	140	185	243	—	—	—	7.5	—	850	272	12	400	80																						
650	103	140	180	—	—	—	6	—	730	140	185	243	—	—	—	7.5	—	900	290	15	420	84																						
680	109	145	190	—	—	—	6	—	780	155	206	265	—	—	—	9.5	—	950	308	15	440	88																						
710	112	150	195	—	—	—	6	—	800	155	206	265	—	—	—	9.5	—	980	315	15	460	92																						
730	112	150	195	—	—	—	6	—	850	165	224	290	—	—	—	9.5	—	1000	315	15	480	96																						
750	112	150	195	—	—	—	6	—	870	165	224	290	—	—	—	9.5	—	1060	335	15	500	/500																						
800	122	160	212	—	—	—	7.5	—	920	175	236	308	—	—	—	9.5	—	1090	335	15	530	/530																						
850	132	175	224	—	—	—	7.5	—	980	190	250	335	—	—	—	12	—	1150	355	15	560	/560																						
900	136	180	236	—	—	—	7.5	—	1030	195	258	335	—	—	—	12	—	1220	375	15	600	/600																						
950	145	190	250	—	—	—	9.5	—	1090	206	280	365	—	—	—	12	—	1280	388	15	630	/630																						
1000	150	200	258	—	—	—	9.5	—	1150	218	290	375	—	—	—	15	—	1320	388	15	670	/670																						
1060	160	212	272	—	—	—	9.5	—	1220	230	308	400	—	—	—	15	—	1400	412	15	710	/710																						
1120	165	224	290	—	—	—	9.5	—	1280	236	315	412	—	—	—	15	—	—	—	—	750	/750																						
1180	170	230	300	—	—	—	9.5	—	1360	250	335	438	—	—	—	15	—	—	—	—	800	/800																						
1250	180	243	315	—	—	—	12	—	1440	—	354	—	—	—	—	15	—	—	—	—	850	/850																						
1320	190	250	335	—	—	—	12	—	1520	—	372	—	—	—	—	15	—	—	—	—	900	/900																						
1400	200	272	355	—	—	—	12	—	1600	—	390	—	—	—	—	15	—	—	—	—	950	/950																						
1460	—	276	—	—	—	—	12	—	1670	—	402	—	—	—	—	15	—	—	—	—	1000	/1000																						
1540	—	288	—	—	—	—	15	—	1770	—	426	—	—	—	—	15	—	—	—	—	1060	/1060																						
1630	—	306	—	—																																								

Table 6. 4 Dimensions of Snap Ring Grooves and Locating Snap Rings — (1)
Bearings of Dimension Series 18 and 19

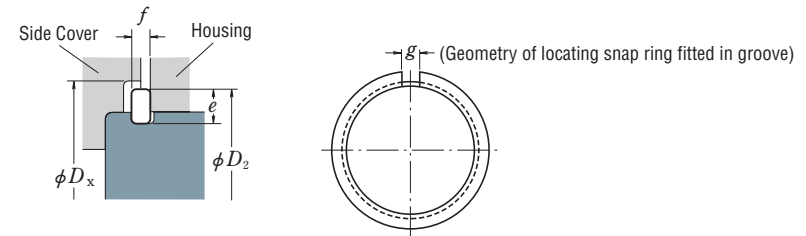
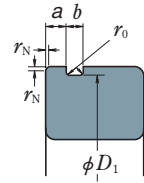

Applicable Bearings		Snap Ring Groove									
Dimension Series	<i>d</i>	<i>D</i>	Snap Ring Groove Diameter <i>D</i> ₁		Snap Ring Groove Position <i>a</i>				Snap Ring Groove Width <i>b</i>		Radius of Bottom Corners <i>r</i> ₀
					Bearing Dimension Series						
			18	19	max.	min.	max.	min.	max.	min.	
—	10	22	20.8	20.5	—	—	1.05	0.9	1.05	0.8	0.2
—	12	24	22.8	22.5	—	—	1.05	0.9	1.05	0.8	0.2
—	15	28	26.7	26.4	—	—	1.3	1.15	1.2	0.95	0.25
—	17	30	28.7	28.4	—	—	1.3	1.15	1.2	0.95	0.25
20	—	32	30.7	30.4	1.3	1.15	—	—	1.2	0.95	0.25
22	—	34	32.7	32.4	1.3	1.15	—	—	1.2	0.95	0.25
25	20	37	35.7	35.4	1.3	1.15	1.7	1.55	1.2	0.95	0.25
—	22	39	37.7	37.4	—	—	1.7	1.55	1.2	0.95	0.25
28	—	40	38.7	38.4	1.3	1.15	—	—	1.2	0.95	0.25
30	25	42	40.7	40.4	1.3	1.15	1.7	1.55	1.2	0.95	0.25
32	—	44	42.7	42.4	1.3	1.15	—	—	1.2	0.95	0.25
—	28	45	43.7	43.4	—	—	1.7	1.55	1.2	0.95	0.25
35	30	47	45.7	45.4	1.3	1.15	1.7	1.55	1.2	0.95	0.25
40	32	52	50.7	50.4	1.3	1.15	1.7	1.55	1.2	0.95	0.25
—	35	55	53.7	53.4	—	—	1.7	1.55	1.2	0.95	0.25
45	—	58	56.7	56.4	1.3	1.15	—	—	1.2	0.95	0.25
—	40	62	60.7	60.3	—	—	1.7	1.55	1.2	0.95	0.25
50	—	65	63.7	63.3	1.3	1.15	—	—	1.2	0.95	0.25
—	45	68	66.7	66.3	—	—	1.7	1.55	1.2	0.95	0.25
55	50	72	70.7	70.3	1.7	1.55	1.7	1.55	1.2	0.95	0.25
60	—	78	76.2	75.8	1.7	1.55	—	—	1.6	1.3	0.4
—	55	80	77.9	77.5	—	—	2.1	1.9	1.6	1.3	0.4
65	60	85	82.9	82.5	1.7	1.55	2.1	1.9	1.6	1.3	0.4
70	65	90	87.9	87.5	1.7	1.55	2.1	1.9	1.6	1.3	0.4
75	—	95	92.9	92.5	1.7	1.55	—	—	1.6	1.3	0.4
80	70	100	97.9	97.5	1.7	1.55	2.5	2.3	1.6	1.3	0.4
—	75	105	102.6	102.1	—	—	2.5	2.3	1.6	1.3	0.4
85	80	110	107.6	107.1	2.1	1.9	2.5	2.3	1.6	1.3	0.4
90	—	115	112.6	112.1	2.1	1.9	—	—	1.6	1.3	0.4
95	85	120	117.6	117.1	2.1	1.9	3.3	3.1	1.6	1.3	0.4
100	90	125	122.6	122.1	2.1	1.9	3.3	3.1	1.6	1.3	0.4
105	95	130	127.6	127.1	2.1	1.9	3.3	3.1	1.6	1.3	0.4
110	100	140	137.6	137.1	2.5	2.3	3.3	3.1	2.2	1.9	0.6
—	105	145	142.6	142.1	—	—	3.3	3.1	2.2	1.9	0.6
120	110	150	147.6	147.1	2.5	2.3	3.3	3.1	2.2	1.9	0.6
130	120	165	161.8	161.3	3.3	3.1	3.7	3.5	2.2	1.9	0.6
140	—	175	171.8	171.3	3.3	3.1	—	—	2.2	1.9	0.6
—	130	180	176.8	176.3	—	—	3.7	3.5	2.2	1.9	0.6
150	140	190	186.8	186.3	3.3	3.1	3.7	3.5	2.2	1.9	0.6
160	—	200	196.8	196.3	3.3	3.1	—	—	2.2	1.9	0.6

Remarks The minimum permissible chamfer dimensions *r*₀ on the snap-ring-groove side of the outer rings are as follows:
 Dimension series 18 : For outside diameters of 78 mm or less, use a 0.3 mm chamfer.
 For all others exceeding 78 mm, use 0.5 mm chamfer.
 Dimension series 19 : For outside diameters of 24 mm or less, use a 0.2 mm chamfer.
 For 47mm or less, use a 0.3 mm chamfer.
 For those exceeding 47 mm, use a 0.5 mm chamfer (However, for an outside diameter of 68 mm, use a 0.3 mm chamfer, though note this is not compliant with ISO 15).

Locating Snap Ring						Side Cover	
Locating Snap Ring Number	Cross Sectional Height <i>e</i>		Thickness <i>f</i>		Geometry of Snap Ring Fitted in Groove (Reference)		Stepped Bore Diameter (Reference) <i>D</i> _x
	max.	min.	max.	min.	Slit Width <i>g</i>	Snap Ring Outside Diameter <i>D</i> ₂	
	approx.		max.		approx.	max.	
NR 1022	2.0	1.85	0.7	0.6	2	24.8	25.5
NR 1024	2.0	1.85	0.7	0.6	2	26.8	27.5
NR 1028	2.05	1.9	0.85	0.75	3	30.8	31.5
NR 1030	2.05	1.9	0.85	0.75	3	32.8	33.5
NR 1032	2.05	1.9	0.85	0.75	3	34.8	35.5
NR 1034	2.05	1.9	0.85	0.75	3	36.8	37.5
NR 1037	2.05	1.9	0.85	0.75	3	39.8	40.5
NR 1039	2.05	1.9	0.85	0.75	3	41.8	42.5
NR 1040	2.05	1.9	0.85	0.75	3	42.8	43.5
NR 1042	2.05	1.9	0.85	0.75	3	44.8	45.5
NR 1044	2.05	1.9	0.85	0.75	4	46.8	47.5
NR 1045	2.05	1.9	0.85	0.75	4	47.8	48.5
NR 1047	2.05	1.9	0.85	0.75	4	49.8	50.5
NR 1052	2.05	1.9	0.85	0.75	4	54.8	55.5
NR 1055	2.05	1.9	0.85	0.75	4	57.8	58.5
NR 1058	2.05	1.9	0.85	0.75	4	60.8	61.5
NR 1062	2.05	1.9	0.85	0.75	4	64.8	65.5
NR 1065	2.05	1.9	0.85	0.75	4	67.8	68.5
NR 1068	2.05	1.9	0.85	0.75	5	70.8	72
NR 1072	2.05	1.9	0.85	0.75	5	74.8	76
NR 1078	3.25	3.1	1.12	1.02	5	82.7	84
NR 1080	3.25	3.1	1.12	1.02	5	84.4	86
NR 1085	3.25	3.1	1.12	1.02	5	89.4	91
NR 1090	3.25	3.1	1.12	1.02	5	94.4	96
NR 1095	3.25	3.1	1.12	1.02	5	99.4	101
NR 1100	3.25	3.1	1.12	1.02	5	104.4	106
NR 1105	4.04	3.89	1.12	1.02	5	110.7	112
NR 1110	4.04	3.89	1.12	1.02	5	115.7	117
NR 1115	4.04	3.89	1.12	1.02	5	120.7	122
NR 1120	4.04	3.89	1.12	1.02	7	125.7	127
NR 1125	4.04	3.89	1.12	1.02	7	130.7	132
NR 1130	4.04	3.89	1.12	1.02	7	135.7	137
NR 1140	4.04	3.89	1.7	1.6	7	145.7	147
NR 1145	4.04	3.89	1.7	1.6	7	150.7	152
NR 1150	4.04	3.89	1.7	1.6	7	155.7	157
NR 1165	4.85	4.7	1.7	1.6	7	171.5	173
NR 1175	4.85	4.7	1.7	1.6	10	181.5	183
NR 1180	4.85	4.7	1.7	1.6	10	186.5	188
NR 1190	4.85	4.7	1.7	1.6	10	196.5	198
NR 1200	4.85	4.7	1.7	1.6	10	206.5	208

Units: mm

BOUNDARY DIMENSIONS AND BEARING DESIGNATIONS

**Table 6. 4 Dimensions of Snap Ring Grooves and Locating Snap Rings — (2)
Bearings of Diameter Series 0, 2, 3, and 4**

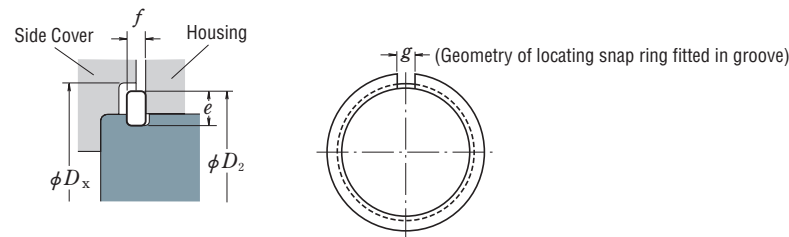
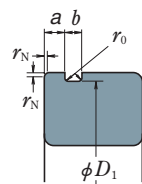

Units: mm

Applicable Bearings					Snap Ring Groove								
<i>d</i>				<i>D</i>	Snap Ring Groove Diameter <i>D</i> ₁		Snap Ring Groove Position <i>a</i>				Snap Ring Groove Width <i>b</i>		Radius of Bottom Corners <i>r</i> ₀
							Bearing Diameter Series						
Diameter Series				max.	min.	0		2, 3, 4		max.	min.	max.	
0	2	3	4			max.	min.	max.	min.				
10	—	—	—	26	24.5	24.25	1.35	1.19	—	—	1.17	0.87	0.2
12	—	—	—	28	26.5	26.25	1.35	1.19	—	—	1.17	0.87	0.2
—	10	9	8	30	28.17	27.91	—	—	2.06	1.9	1.65	1.35	0.4
15	12	—	9	32	30.15	29.9	2.06	1.9	2.06	1.9	1.65	1.35	0.4
17	15	10	—	35	33.17	32.92	2.06	1.9	2.06	1.9	1.65	1.35	0.4
—	—	12	10	37	34.77	34.52	—	—	2.06	1.9	1.65	1.35	0.4
—	—	17	—	40	38.1	37.85	—	—	2.06	1.9	1.65	1.35	0.4
20	—	15	12	42	39.75	39.5	2.06	1.9	2.06	1.9	1.65	1.35	0.4
22	—	—	—	44	41.75	41.5	2.06	1.9	—	—	1.65	1.35	0.4
25	20	17	—	47	44.6	44.35	2.06	1.9	2.46	2.31	1.65	1.35	0.4
—	—	22	—	50	47.6	47.35	—	—	2.46	2.31	1.65	1.35	0.4
28	25	20	15	52	49.73	49.48	2.06	1.9	2.46	2.31	1.65	1.35	0.4
30	—	—	—	55	52.6	52.35	2.08	1.88	—	—	1.65	1.35	0.4
—	—	22	—	56	53.6	53.35	—	—	2.46	2.31	1.65	1.35	0.4
32	28	—	—	58	55.6	55.35	2.08	1.88	2.46	2.31	1.65	1.35	0.4
35	30	25	17	62	59.61	59.11	2.08	1.88	3.28	3.07	2.2	1.9	0.6
—	—	32	—	65	62.6	62.1	—	—	3.28	3.07	2.2	1.9	0.6
40	—	28	—	68	64.82	64.31	2.49	2.29	3.28	3.07	2.2	1.9	0.6
—	—	35	30	72	68.81	68.3	—	—	3.28	3.07	2.2	1.9	0.6
45	—	32	—	75	71.83	71.32	2.49	2.29	3.28	3.07	2.2	1.9	0.6
50	40	35	25	80	76.81	76.3	2.49	2.29	3.28	3.07	2.2	1.9	0.6
—	—	45	—	85	81.81	81.31	—	—	3.28	3.07	2.2	1.9	0.6
55	50	40	30	90	86.79	86.28	2.87	2.67	3.28	3.07	3	2.7	0.6
60	—	—	—	95	91.82	91.31	2.87	2.67	—	—	3	2.7	0.6
65	55	45	35	100	96.8	96.29	2.87	2.67	3.28	3.07	3	2.7	0.6
70	60	50	40	110	106.81	106.3	2.87	2.67	3.28	3.07	3	2.7	0.6
75	—	—	—	115	111.81	111.3	2.87	2.67	—	—	3	2.7	0.6
—	—	55	45	120	115.21	114.71	—	—	4.06	3.86	3.4	3.1	0.6
80	70	—	—	125	120.22	119.71	2.87	2.67	4.06	3.86	3.4	3.1	0.6
85	75	60	50	130	125.22	124.71	2.87	2.67	4.06	3.86	3.4	3.1	0.6
90	80	65	55	140	135.23	134.72	3.71	3.45	4.9	4.65	3.4	3.1	0.6
95	—	—	—	145	140.23	139.73	3.71	3.45	—	—	3.4	3.1	0.6
100	85	70	60	150	145.24	144.73	3.71	3.45	4.9	4.65	3.4	3.1	0.6
105	90	75	65	160	155.22	154.71	3.71	3.45	4.9	4.65	3.4	3.1	0.6
110	95	80	—	170	163.65	163.14	3.71	3.45	5.69	5.44	3.8	3.5	0.6
120	100	85	70	180	173.66	173.15	3.71	3.45	5.69	5.44	3.8	3.5	0.6
—	—	105	90	190	183.64	183.13	—	—	5.69	5.44	3.8	3.5	0.6
130	110	95	80	200	193.65	193.14	5.69	5.44	5.69	5.44	3.8	3.5	0.6

Locating Snap Ring Number	Cross Sectional Height				Thickness		Geometry of Snap Ring Fitted in Groove (Reference)		Side Cover
	max.		min.		max.		max.		Stepped Bore Diameter (Reference) <i>D</i> _X
NR 26 (1)	2.06	1.91	0.84	0.74	3	28.7	29.4		
NR 28 (1)	2.06	1.91	0.84	0.74	3	30.7	31.4		
NR 30	3.25	3.1	1.12	1.02	3	34.7	35.5		
NR 32	3.25	3.1	1.12	1.02	3	36.7	37.5		
NR 35	3.25	3.1	1.12	1.02	3	39.7	40.5		
NR 37	3.25	3.1	1.12	1.02	3	41.3	42		
NR 40	3.25	3.1	1.12	1.02	3	44.6	45.5		
NR 42	3.25	3.1	1.12	1.02	3	46.3	47		
NR 44	3.25	3.1	1.12	1.02	3	48.3	49		
NR 47	4.04	3.89	1.12	1.02	4	52.7	53.5		
NR 50	4.04	3.89	1.12	1.02	4	55.7	56.5		
NR 52	4.04	3.89	1.12	1.02	4	57.9	58.5		
NR 55	4.04	3.89	1.12	1.02	4	60.7	61.5		
NR 56	4.04	3.89	1.12	1.02	4	61.7	62.5		
NR 58	4.04	3.89	1.12	1.02	4	63.7	64.5		
NR 62	4.04	3.89	1.7	1.6	4	67.7	68.5		
NR 65	4.04	3.89	1.7	1.6	4	70.7	71.5		
NR 68	4.85	4.7	1.7	1.6	5	74.6	76		
NR 72	4.85	4.7	1.7	1.6	5	78.6	80		
NR 75	4.85	4.7	1.7	1.6	5	81.6	83		
NR 80	4.85	4.7	1.7	1.6	5	86.6	88		
NR 85	4.85	4.7	1.7	1.6	5	91.6	93		
NR 90	4.85	4.7	2.46	2.36	5	96.5	98		
NR 95	4.85	4.7	2.46	2.36	5	101.6	103		
NR 100	4.85	4.7	2.46	2.36	5	106.5	108		
NR 110	4.85	4.7	2.46	2.36	5	116.6	118		
NR 115	4.85	4.7	2.46	2.36	5	121.6	123		
NR 120	7.21	7.06	2.82	2.72	7	129.7	131.5		
NR 125	7.21	7.06	2.82	2.72	7	134.7	136.5		
NR 130	7.21	7.06	2.82	2.72	7	139.7	141.5		
NR 140	7.21	7.06	2.82	2.72	7	149.7	152		
NR 145	7.21	7.06	2.82	2.72	7	154.7	157		
NR 150	7.21	7.06	2.82	2.72	7	159.7	162		
NR 160	7.21	7.06	2.82	2.72	7	169.7	172		
NR 170	9.6	9.45	3.1	3	10	182.9	185		
NR 180	9.6	9.45	3.1	3	10	192.9	195		
NR 190	9.6	9.45	3.1	3	10	202.9	205		
NR 200	9.6	9.45	3.1	3	10	212.9	215		

Note (1) The locating snap rings and snap ring grooves of these bearings are not specified by ISO.
Remarks 1. The dimensions of these snap ring grooves are not applicable to bearings of Dimension Series 00, 82, and 83.
 2. The minimum permissible chamfer dimension *r*_N on the snap-ring side of outer rings is 0.5 mm. However, for Diameter Series 0 bearings with outside diameters of 35 mm or below, it is 0.3 mm.

BOUNDARY DIMENSIONS AND BEARING DESIGNATIONS

6.2 Formulation of Bearing Designations

Bearing designations (or "bearing numbers") are alphanumeric combinations that indicate the bearing type, boundary dimensions, dimensional and running accuracies, internal clearance, and other related specifications. The boundary dimensions of commonly used bearings mostly conform to the organizational concept of ISO, and the bearing numbers of these standard bearings are specified by JIS B 1513 (*Rolling bearings- Designation*). Due to a need for more detailed classification, NSK uses auxiliary designations other than those specified by JIS.

Bearing designations consist of a basic designation and supplementary designations. The basic designation indicates the bearing series (type) and the width and diameter series as shown in Table 6.5. Basic designations, supplementary designations, and the meanings of common numbers and designations are listed in Table 6.6 (Pages A122 and A123). Contact angle and other supplementary designations are shown in successive columns from left to right in Table 6.6. For reference, some example designations are shown here:

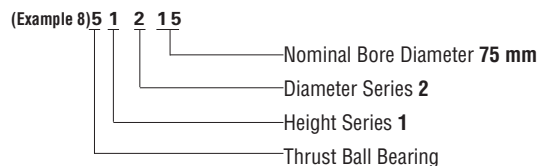
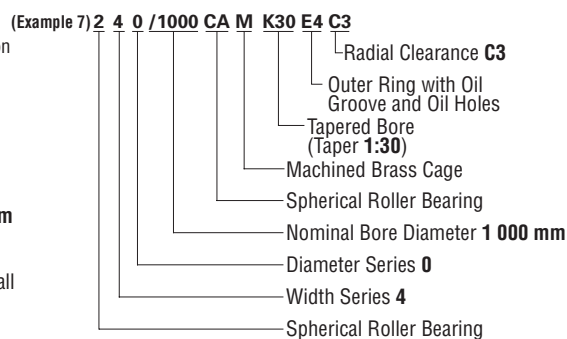
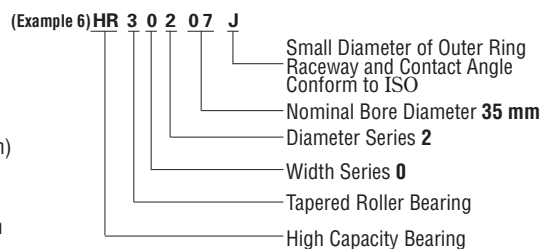
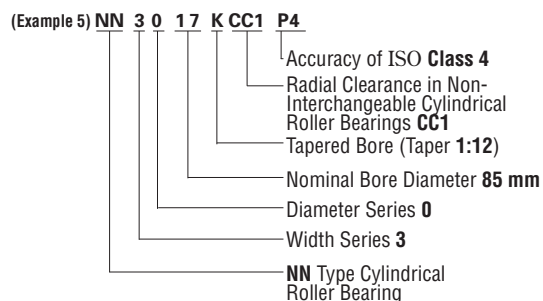
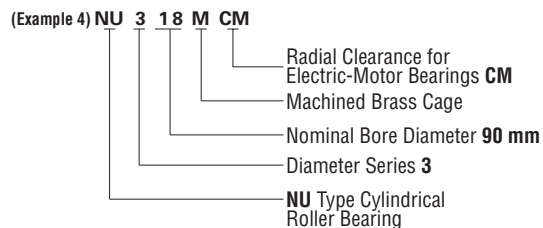
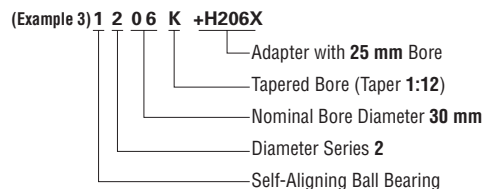
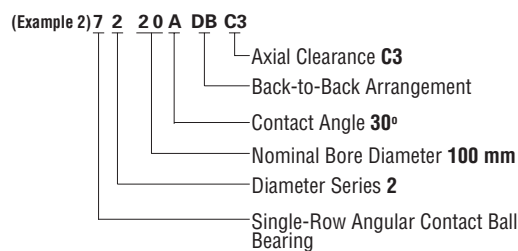
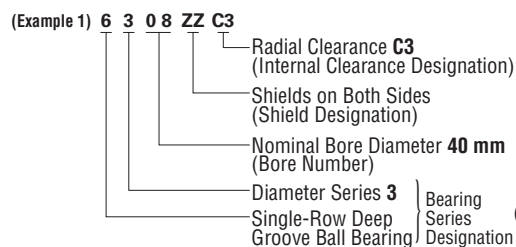

Table 6.5 Bearing Series Designations

Bearing Type	Bearing Series	Type	Dimensions	
			Width	Diameter
Single-Row Deep Groove Ball Bearings	68	6	(1)	8
	69	6	(1)	9
	60	6	(1)	0
	62	6	(0)	2
Single-Row Angular Contact Ball Bearings	63	6	(0)	3
	79	7	(1)	9
	70	7	(1)	0
Self-Aligning Ball Bearings	72	7	(0)	2
	73	7	(0)	3
	12	1	(0)	2
	13	1	(0)	3
Tapered Roller Bearings	22	(1)	2	2
	23	(1)	2	3
	NU10	NU	1	0
	NU2	NU	(0)	2
Single-Row Cylindrical Roller Bearings	NU22	NU	2	2
	NU3	NU	(0)	3
	NU23	NU	2	3
	NU4	NU	(0)	4
	NJ2	NJ	(0)	2
	NJ22	NJ	2	2
	NJ3	NJ	(0)	3
	NJ23	NJ	2	3
Thrust Ball Bearings with Flat Seats	NJ4	NJ	(0)	4
	NUP2	NUP	(0)	2
	NUP22	NUP	2	2
	NUP3	NUP	(0)	3
Spherical Thrust Roller Bearings	NUP23	NUP	2	3
	NUP4	NUP	(0)	4
	N10	N	1	0
	N2	N	(0)	2
Spherical Roller Bearings	N3	N	(0)	3
	N4	N	(0)	4
	NF2	NF	(0)	2
	NF3	NF	(0)	3
Thrust Ball Bearings with Flat Seats	NF4	NF	(0)	4
	230	2	3	0
	231	2	3	1
Spherical Roller Bearings	222	2	2	2
	232	2	3	2
	213⁽¹⁾	2	0	3
	223	2	2	3
	511	5	1	1
Spherical Thrust Roller Bearings	512	5	1	2
	513	5	1	3
	514	5	1	4
	522	5	2	2
Spherical Thrust Roller Bearings	523	5	2	3
	524	5	2	4
	292	2	9	2
Spherical Thrust Roller Bearings	293	2	9	3
	294	2	9	4

Note ⁽¹⁾ Bearing Series 213 should logically be 203, but customarily it is numbered 213.
Remark Numbers in parentheses () in the width column are usually omitted from the bearing number.

Table 6.6 Formulation of

Basic Designations						External Features							
Bearing Series (1)		Bore Number		Contact Angle		Internal Design		Material		Cage		Seals, Shields	
Code	Meaning	Code	Meaning	Code	Meaning	Code	Meaning	Code	Meaning	Code	Meaning	Code	Meaning
68	Single-Row Deep Groove Ball Bearings	1	Bore Diam. 1 mm	A	Angular Contact Ball Bearings	A	Internal Design Differs From Standard	g	Case-Hardened Steel Used in Rings, Rolling Elements	M	Machined-Brass Cage	Z	} Shield on One Side Only
69	Single-Row Deep Groove Ball Bearings	2	2	A	Standard Contact Angle of 30°	J	Smaller Diameter of Outer Ring Raceway, Contact Angle, and Outer Ring Width of Tapered Roller Bearings (Conforms to ISO 355)	h	Stainless Steel Used in Rings, Rolling Elements	W	Pressed-Steel Cage	ZS	
70	Single-Row Angular Contact Ball Bearings	3	3	A5	Standard Contact Angle of 25°							ZZ	} Shields on Both Sides
72	Single-Row Angular Contact Ball Bearings	9	9									ZZS	
73	Self-Aligning Ball Bearings	00	10	B	Standard Contact Angle of 40°							DU	Rubber Contact Seal on One Side Only
12	Self-Aligning Ball Bearings	01	12										
13	Self-Aligning Ball Bearings	02	15										
22	Self-Aligning Ball Bearings	03	17										
NU10	Cylindrical Roller Bearings	/22	22	C	Standard Contact Angle of 15°		(For High Capacity Bearings)					T	Synthetic Resin Cage
NJ 2	Cylindrical Roller Bearings	/28	28										
N 3	Cylindrical Roller Bearings	/32	32										
NN 30	Cylindrical Roller Bearings	/32	32										
NA48	Needle Roller Bearings	04(4)	20	CA	Tapered Roller Bearings	CA	} Spherical Roller Bearings						
NA49	Needle Roller Bearings	05	25	CD	Omitted Contact Angle Less Than 17°	CD							
NA69	Needle Roller Bearings	06	30	EA	Approx. 20° Contact Angle	EA							
320	Tapered Roller Bearings (2)	88	440			E	Cylindrical Roller Bearings					V	Rubber Non-Contact Seal on One Side Only
322	Tapered Roller Bearings (2)	92	460										
323	Tapered Roller Bearings (2)	96	480										
230	Spherical Roller Bearings	/500	500									VV	Rubber Non-Contact Seals on Both Sides
222	Spherical Roller Bearings	/530	530										
223	Spherical Roller Bearings	/560	560										
511	Thrust Ball Bearing With Flat Seats	/530	530	D	Approx. 28° Contact Angle	E	Spherical Thrust Roller Bearings						
512	Thrust Ball Bearing With Flat Seats	/560	560										
513	Thrust Ball Bearing With Flat Seats												
292	Thrust Spherical Roller Bearings	/2 360	2 360										
293	Thrust Spherical Roller Bearings	/2 500	2 500										
294	Thrust Spherical Roller Bearings												
HR(4)	High Capacity Tapered Roller Bearings and Others												
Designations and Numbers Conform to JIS(5)						NSK Designations						NSK Designations	
Marked on Bearings										Not Marked on Bearings			

Notes (1) Bearing Series designations conform to Table 6.5.
 (2) For basic designations of tapered roller bearings in ISO's new series, refer to Page C182.
 (3) The bore size (mm) is five times the bore number for Bore Numbers 04 through 96 (except double-direction thrust ball bearings).
 (4) HR is an NSK Bearing Series designation.

Bearing Designations

Auxiliary Designations													
External Features		Arrangement		Internal Clearance / Preload		Tolerance Class		Special Specification		Spacer / Sleeve		Grease	
Design of Rings		Code Meaning		Code Meaning (radial clearance)		Code Meaning		Code Meaning		Code Meaning		Code Meaning	
K	Tapered Bore of Inner Ring (Taper 1:12)	DB	Back-to-Back Arrangement	C1	Clearance Less Than C2	Omitted	ISO Normal			+K	Bearings With Outer Ring Spacers	AS2	SHELL ALVANIA GREASE S2
K30	Tapered Bore of Inner Ring (Taper 1:30)	DF	Face-to-Face Arrangement	C2	Clearance Less Than CN	Omitted	ISO Class 6	X26	Working Temperature Lower Than 150 °C	+L	Bearings With Inner Ring Spacers	NS7	NS HI-LUBE
				C3	Clearance Greater Than CN								
				C4	Clearance Greater Than C3								
				C5	Clearance Greater Than C4								
E	Notch or Lubricating Groove in Ring	DT	Tandem Arrangement	CC1	Clearance Less Than CC2	P5	ISO Class 5	X28	Working Temperature Lower Than 200 °C	+KL	Bearings With Both Inner and Outer Ring Spacers	PS2	MULTEMP PS No. 2
				CC2	Clearance Less Than CC								
E4	Lubricating Groove in Outside Surface and Holes in Outer Ring			CC	Normal Clearance	P4	ISO Class 4	X29	Working Temperature Lower Than 250 °C	H	Adapter	AH	Withdrawal Sleeve
				CC3	Clearance Greater Than CC								
NR	Snap Ring Groove With Snap Ring in Outer Ring			CC4	Clearance Greater Than CC3	ABMA(7) Tapered Roller Bearing	Class 4	S11	Dimensional Stabilizing Treatment Working Temperature Lower Than 200 °C	HJ	Thrust Collar		
				CC5	Clearance Greater Than CC4								
N	Snap Ring Groove in Outer Ring			MC1	Clearance Less Than MC2	Omitted	Class 4						
				MC2	Clearance Less Than MC3								
NR	Snap Ring Groove With Snap Ring in Outer Ring			MC3	Normal Clearance	PN2	Class 2						
				MC4	Clearance Greater Than MC3								
NR	Snap Ring Groove With Snap Ring in Outer Ring			MC5	Clearance Greater Than MC4	PN3	Class 3						
				MC6	Clearance Greater Than MC5								
NR	Snap Ring Groove With Snap Ring in Outer Ring			CM	Clearance in Deep Groove Ball Bearings for Electric Motors	PN0	Class 0						
				CT	Clearance in Cylindrical Roller Bearings for Electric Motors								
NR	Snap Ring Groove With Snap Ring in Outer Ring			CM	Clearance in Cylindrical Roller Bearings for Electric Motors	PN00	Class 00						
				EL	Extra Light Preload								
NR	Snap Ring Groove With Snap Ring in Outer Ring			L	Light Preload								
				M	Medium Preload								
NR	Snap Ring Groove With Snap Ring in Outer Ring			H	Heavy Preload								
					(Preload of Angular Contact Ball Bearing)								
Partially Match JIS(5)	Match JIS(5)	NSK Designations	Partially Match JIS(5)/BAS(6)	Match JIS(5)	NSK Designations, Partially Match JIS(5)								
In General, Marked on Bearings										Not Marked on Bearings			

Notes (5) JIS : Japanese Industrial Standards.
 (6) BAS : The Japan Bearing Industrial Association Standard.
 (7) ABMA : The American Bearing Manufacturers Association.

7. BEARING TOLERANCES

7.1 Bearing Tolerance Standards A 126

7.2 Selection of Tolerance Classes A 151

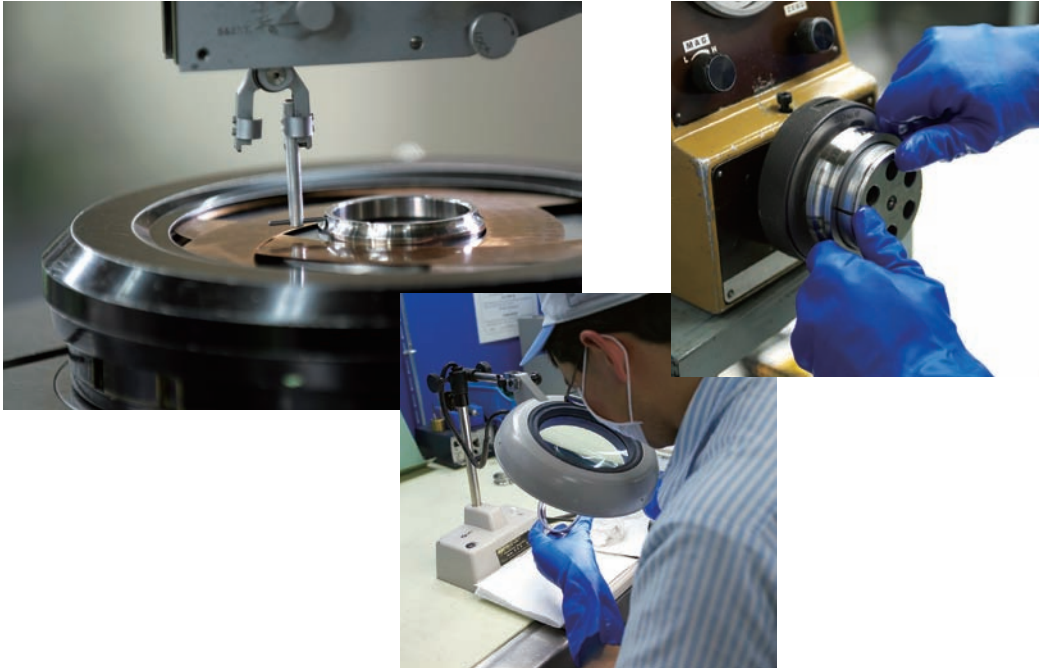

7. BEARING TOLERANCES

7.1 Bearing Tolerance Standards

The tolerances for the boundary dimensions and running accuracy of rolling bearings are specified by ISO 492, 199, and 582. Tolerances are specified for the following items:

Class 2 is the highest bearing tolerance class in ISO but additional classes exist, including Class 6X (for tapered roller bearings), Class 6, Class 5, and Class 4. The applicable tolerance classes for each bearing type and the correspondence of these classes are shown in Table 7.1.

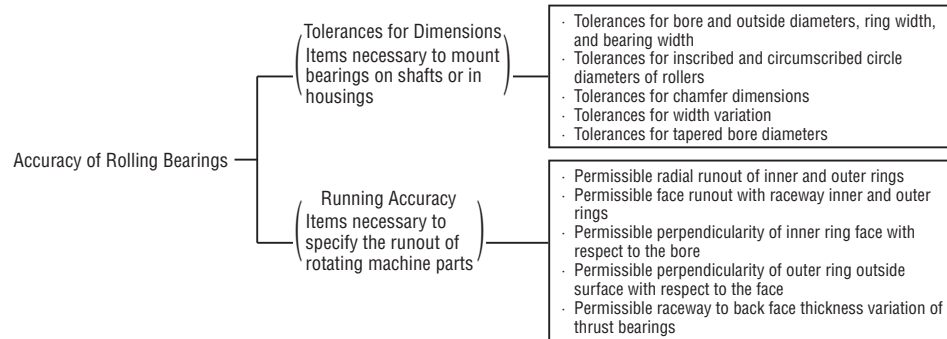

Table 7.1 Bearing Types and Tolerance Classes

Bearing Type		Standard	Normal	Class 6X	Class 6	Class 5	Class 4	Class 2		
Deep Groove Ball Bearing	ISO 492		Normal	—	Class 6	Class 5	Class 4	Class 2		
Angular Contact Ball Bearings			Normal	—	Class 6	Class 5	Class 4	Class 2		
Self-Aligning Ball Bearings			Normal	—	Class 6 Equivalent	Class 5 Equivalent	—	—		
Cylindrical Roller Bearings			Normal	—	Class 6	Class 5	Class 4	Class 2		
Needle Roller Bearings			Normal	—	Class 6	Class 5	Class 4	—		
Spherical Roller Bearings			Normal	—	Class 6	Class 5	—	—		
Tapered Roller Bearings	Metric Design	ISO 492	Normal	Class 6X	Class 6	Class 5	Class 4	—		
	Inch Design	ANSI/AFBMA Std.19.2	Class 4	—	Class 2	Class 3	Class 0	Class 00		
	J Series	ANSI/AFBMA Std.19.1	Class K	Class N	—	Class C	Class B	—		
Magneto Ball Bearings	BAS1061	Normal	—	Class 6	Class 5	—	—			
Thrust Ball Bearings	ISO 199	Normal	—	Class 6	Class 5	Class 4	—			
Thrust Roller Bearings		Normal	—	—	—	—	—			
Thrust Spherical Roller Bearings		Normal	—	—	—	—	—			
Equivalent Standards (Reference)	JIS			JIS B 1514, 1536	Class 0	—	Class 6	Class 5	Class 4	Class 2
		Tapered Roller Bearings	Metric Design	JIS B 1514	Class 0	Class 6X (Class 6)	Class 5	Class 4	—	
	DIN			DIN620	P0	—	P6	P5	P4	P2
		Ball Bearings	Roller Bearings	ANSI/AFBMA Std.20	ABEC1	—	ABEC3	ABEC5	ABEC7	ABEC9
	ANSI/AFBMA			ANSI/AFBMA Std.12.2	—	—	—	Class 5P	Class 7P	Class 9P
		Tapered Roller Bearings	Metric Design	ANSI/AFBMA Std.19.1	Class K	Class N	—	Class C	Class B	Class A
	BAS	Tapered Roller Bearings	Metric Design	Multi/Four-Row	BAS1002	Class 0	—	—	—	—

(Reference) Rough definitions of items related to running accuracy and their measuring methods are shown in Fig. 7.1. These are further described in detail in ISO 5593 (*Rolling Bearings-Vocabulary*), JIS B 1515, (*Rolling Bearings-Tolerances*) and elsewhere.

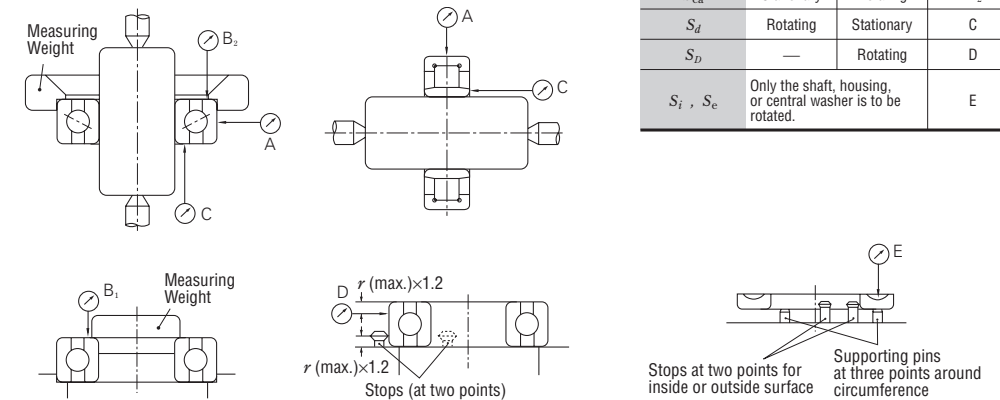

Fig. 7.1 Measuring Methods for Running Accuracy (Summarized)

Supplementary Table

Running Accuracy	Inner Ring	Outer Ring	Dial Gauge
K_{ia}	Rotating	Stationary	A
K_{ea}	Stationary	Rotating	A
S_{ia}	Rotating	Stationary	B_1
S_{ea}	Stationary	Rotating	B_2
S_d	Rotating	Stationary	C
S_D	—	Rotating	D
S_i, S_e	Only the shaft, housing, or central washer is to be rotated.		E

Symbols for Boundary Dimensions and Running Accuracy

d	Nominal bore diameter	D	Nominal outside diameter
Δ_{ds}	Deviation of a single bore diameter	Δ_{Ds}	Deviation of a single outside diameter
Δ_{dmp}	Single plane mean bore diameter deviation	Δ_{Dmp}	Single plane mean outside diameter deviation
V_{dp}	Bore diameter variation in a single radial plane	V_{Dp}	Outside diameter variation in a single radial plane
V_{dmp}	Mean bore diameter variation	V_{Dmp}	Mean outside diameter variation
V_{dsp}	Variation of bore diameter in a single plane	V_{Dsp}	Variation of outside diameter in a single plane
B	Inner ring width, nominal	C	Nominal outer ring width
Δ_{Bs}	Deviation of a single inner ring width	Δ_{Cs}	Deviation of a single outer ring width
V_{Bs}	Inner ring width variation	V_{Cs}	Outer ring width variation
K_{ia}	Radial runout of assembled brg. inner ring	K_{ea}	Radial runout of assembled brg. outer ring
S_d	Perpendicularity of inner ring face with respect to the bore	S_D	Perpendicularity of outer ring outside surface with respect to the face
S_{ia}	Axial runout of inner ring of assembled bearing	S_{ea}	Axial runout of outer ring of assembled bearing
S_i, S_e	Parallelism of inner ring raceway with respect to the face		
T	Nominal (assembled) bearing width		
Δ_{Ts}	Deviation of the actual brg. width		
Δ_{TIs}	Deviation of the actual effective width of inner subunit		
Δ_{T2s}	Deviation of the actual effective width of outer ring		

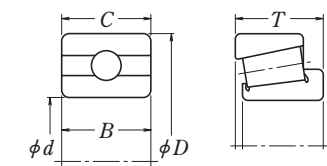

Table 7. 2 Tolerances for Radial Bearings
Table 7. 2. 2 Tolerances

Nominal Outside Diameter <i>D</i> (mm)		Δ_{Dmp}										Δ_{Ds}			
		Normal Class		Class 6		Class 5		Class 4		Class 2		Class 4		Class 2	
												high	low	high	low
		Diameter Series													
0, 1, 2, 3, 4															
over	incl.	high	low	high	low	high	low	high	low	high	low	high	low	high	low
2.5 ⁽¹⁾	6	0	-8	0	-7	0	-5	0	-4	0	-2.5	0	-4	0	-2.5
6	18	0	-8	0	-7	0	-5	0	-4	0	-2.5	0	-4	0	-2.5
18	30	0	-9	0	-8	0	-6	0	-5	0	-4	0	-5	0	-4
30	50	0	-11	0	-9	0	-7	0	-6	0	-4	0	-6	0	-4
50	80	0	-13	0	-11	0	-9	0	-7	0	-4	0	-7	0	-4
80	120	0	-15	0	-13	0	-10	0	-8	0	-5	0	-8	0	-5
120	150	0	-18	0	-15	0	-11	0	-9	0	-5	0	-9	0	-5
150	180	0	-25	0	-18	0	-13	0	-10	0	-7	0	-10	0	-7
180	250	0	-30	0	-20	0	-13	0	-11	0	-8	0	-11	0	-8
250	315	0	-35	0	-25	0	-18	0	-13	0	-8	0	-13	0	-8
315	400	0	-40	0	-28	0	-20	0	-15	0	-10	0	-15	0	-10
400	500	0	-45	0	-33	0	-23	—	—	—	—	—	—	—	—
500	630	0	-50	0	-38	0	-28	—	—	—	—	—	—	—	—
630	800	0	-75	0	-45	0	-35	—	—	—	—	—	—	—	—
800	1 000	0	-100	0	-60	—	—	—	—	—	—	—	—	—	—
1 000	1 250	0	-125	—	—	—	—	—	—	—	—	—	—	—	—
1 250	1 600	0	-160	—	—	—	—	—	—	—	—	—	—	—	—
1 600	2 000	0	-200	—	—	—	—	—	—	—	—	—	—	—	—
2 000	2 500	0	-250	—	—	—	—	—	—	—	—	—	—	—	—

- Notes** (1) 2.5 mm is included in this group.
 (2) Applicable only when a locating snap ring is not used.
 (3) Applicable to ball bearings, such as deep groove ball bearings and angular contact ball bearings.
 (4) Not applicable to bearings with flanges.
 (5) The tolerances for outer ring width variation in Normal Class and Class 6 bearings are shown in Table 7.2.1.
- Remarks** 1. The outside diameter "no-go side" tolerances (low) specified in this table do not necessarily apply within a distance from the ring face to 1.2 times the chamfer dimension *r* (max).
 2. AISI/ABMA Std 20-1996: ABEC1-RBEC1, ABEC3-RBEC3, ABEC5-RBEC5, ABEC7-RBEC7, and ABEC9-RBEC9 are equivalent to Classes Normal, 6, 5, 4, and 2 respectively.

(Excluding Tapered Roller Bearings)
for Outer Rings

V_{Dsp} (°)														V_{Dmp} (°)				
Normal Class				Class 6				Class 5		Class 4		Class 2		Normal Class	Class 6	Class 5	Class 4	Class 2
Open Bearings		Sealed/ Shielded Bearings		Open Bearings		Sealed/ Shielded Bearings		Open Bearings	Open Bearings	Open Bearings								
Diameter Series				Diameter Series				Diameter Series	Diameter Series	Diameter Series								
9	0, 1	2, 3, 4	2, 3, 4	9	0, 1	2, 3, 4	0, 1, 2, 3, 4	9	1, 2, 3, 4	9	1, 2, 3, 4	0, 1, 2, 3, 4						
Max.				Max.				Max.	Max.	Max.		Max.	Max.	Max.	Max.	Max.		
10	8	6	10	9	7	5	9	5	4	4	3	2.5	6	5	3	2	1.5	
10	8	6	10	9	7	5	9	5	4	4	3	2.5	6	5	3	2	1.5	
12	9	7	12	10	8	6	10	6	5	5	4	4	7	6	3	2.5	2	
14	11	8	16	11	9	7	13	7	5	6	5	4	8	7	4	3	2	
16	13	10	20	14	11	8	16	9	7	7	5	4	10	8	5	3.5	2	
19	19	11	26	16	16	10	20	10	8	8	6	5	11	10	5	4	2.5	
23	23	14	30	19	19	11	25	11	8	9	7	5	14	11	6	5	2.5	
31	31	19	38	23	23	14	30	13	10	10	8	7	19	14	7	5	3.5	
38	38	23	—	25	25	15	—	15	11	11	8	8	23	15	8	6	4	
44	44	26	—	31	31	19	—	18	14	13	10	8	26	19	9	7	4	
50	50	30	—	35	35	21	—	20	15	15	11	10	30	21	10	8	5	
56	56	34	—	41	41	25	—	23	17	—	—	—	34	25	12	—	—	
63	63	38	—	48	48	29	—	28	21	—	—	—	38	29	14	—	—	
94	94	55	—	56	56	34	—	35	26	—	—	—	55	34	18	—	—	
125	125	75	—	75	75	45	—	—	—	—	—	—	75	45	—	—	—	
—	—	—	—	—	—	—	—	—	—	—	—	—	—	—	—	—	—	
—	—	—	—	—	—	—	—	—	—	—	—	—	—	—	—	—	—	
—	—	—	—	—	—	—	—	—	—	—	—	—	—	—	—	—	—	

Units : m

K_{α}					S_D (°)			S_{α} (°)(°)			V_{α} (°)			Nominal Outside Diameter <i>D</i> (mm)		
Normal Class	Class 6	Class 5	Class 4	Class 2	Class 5	Class 4	Class 2	Class 5	Class 4	Class 2	Class 5	Class 4	Class 2			
Max.	Max.	Max.	Max.	Max.	Max.	Max.	Max.	Max.	Max.	Max.	Max.	Max.	Max.			
15	8	5	3	1.5	8	4	1.5	8	5	1.5	5	2.5	1.5	2.5	6	18
15	8	5	3	1.5	8	4	1.5	8	5	1.5	5	2.5	1.5	2.5	6	18
15	9	6	4	2.5	8	4	1.5	8	5	2.5	5	2.5	1.5	2.5	18	30
20	10	7	5	2.5	8	4	1.5	8	5	2.5	5	2.5	1.5	2.5	30	50
25	13	8	5	4	8	4	1.5	10	5	4	6	3	1.5	1.5	50	80
35	18	10	6	5	9	5	2.5	11	6	5	8	4	2.5	2.5	80	120
40	20	11	7	5	10	5	2.5	13	7	5	8	5	2.5	2.5	120	150
45	23	13	8	5	10	5	2.5	14	8	5	8	5	2.5	2.5	150	180
50	25	15	10	7	11	7	4	15	10	7	10	7	4	4	180	250
60	30	18	11	7	13	8	5	18	10	7	11	7	5	5	250	315
70	35	20	13	8	13	10	7	20	13	8	13	8	7	7	315	400
80	40	23	—	—	15	—	—	23	—	—	15	—	—	—	400	500
100	50	25	—	—	18	—	—	25	—	—	18	—	—	—	500	630
120	60	30	—	—	20	—	—	30	—	—	20	—	—	—	630	800
140	75	—	—	—	—	—	—	—	—	—	—	—	—	—	800	1 000
160	—	—	—	—	—	—	—	—	—	—	—	—	—	—	1 000	1 250
190	—	—	—	—	—	—	—	—	—	—	—	—	—	—	1 250	1 600
220	—	—	—	—	—	—	—	—	—	—	—	—	—	—	1 600	2 000
250	—	—	—	—	—	—	—	—	—	—	—	—	—	—	2 000	2 500

Table 7.3 Tolerances for Metric Series Tapered Roller Bearings
Table 7.3.1 Tolerances for Inner Ring Bore Diameter and Running Accuracy

Nominal Bore Diameter <i>d</i> (mm)	Δ_{dmp}								Δ_{ds}				V_{dsp}				V_{dmp}										
	Normal Class Class 6X		(Class 6)		Class 5		Class 4		Class 4		Normal Class Class 6X		(Class 6)		Class 5		Class 4		Normal Class Class 6X		(Class 6)		Class 5		Class 4		
	over	incl.	high	low	high	low	high	low	high	low	high	low	Max.	Max.	Max.	Max.	Max.	Max.	Max.	Max.	Max.	Max.	Max.	Max.	Max.	Max.	
10 ⁽¹⁾	18	0	-12	0	-7	0	-7	0	-5	0	-5	12	7	5	4	9	5	5	4	15	8	5	4	15	8	5	4
18	30	0	-12	0	-8	0	-8	0	-6	0	-6	12	8	6	5	9	6	5	4	20	15	11	8	20	15	11	8
30	50	0	-12	0	-10	0	-10	0	-8	0	-8	12	10	8	6	9	8	5	5	25	18	14	10	25	18	14	10
50	80	0	-15	0	-12	0	-12	0	-9	0	-9	15	12	9	7	11	9	6	5	30	22	17	11	30	22	17	11
80	120	0	-20	0	-15	0	-15	0	-10	0	-10	20	15	11	8	15	11	8	5	40	30	23	15	40	30	23	15
120	180	0	-25	0	-18	0	-18	0	-13	0	-13	25	18	14	10	19	14	9	7	40	30	23	15	40	30	23	15
180	250	0	-30	0	-22	0	-22	0	-15	0	-15	30	22	17	11	23	16	11	8	45	35	27	18	45	35	27	18
250	315	0	-35	0	-25	0	-25	0	-18	0	-18	35	27	20	14	26	20	13	9	45	35	27	18	45	35	27	18
315	400	0	-40	0	-30	0	-30	0	-20	0	-20	40	30	23	15	30	23	15	10	45	35	27	18	45	35	27	18
400	500	0	-45	0	-35	0	-35	0	-25	0	-25	45	35	27	20	34	25	17	10	45	35	27	18	45	35	27	18
500	630	0	-60	0	-45	0	-45	0	-30	0	-30	60	45	35	25	40	30	20	12	60	45	35	25	60	45	35	25
630	800	0	-75	0	-55	0	-55	0	-40	0	-40	75	55	40	28	45	35	25	15	75	55	40	28	75	55	40	28
800	1000	0	-100	0	-75	0	-75	0	-50	0	-50	100	75	55	40	55	40	30	15	100	75	55	40	100	75	55	40
1000	1250	0	-125	0	-90	0	-90	0	-60	0	-60	125	90	65	45	65	50	37	15	125	90	65	45	125	90	65	45
1250	1600	0	-160	0	-120	0	-120	0	-80	0	-80	160	120	90	65	80	65	45	15	160	120	90	65	160	120	90	65
1600	2000	0	-200	0	-150	0	-150	0	-100	0	-100	200	150	110	75	100	80	50	15	200	150	110	75	200	150	110	75

Notes ⁽¹⁾ 10 mm is included in this group.

- Remarks 1. The bore diameter "no-go side" tolerances (high) specified in this table do not necessarily apply within a distance from the ring face to 1.2 times the chamfer dimension *r* (max.).
 2. Some of these tolerances conform to NSK standards.

Table 7.3.2 Tolerances for Outer Ring Outside Diameter and Running Accuracy

Nominal Outside Diameter <i>D</i> (mm)	Δ_{Dmp}								Δ_{Ds}				V_{Dsp}				V_{Dmp}										
	Normal Class Class 6X		(Class 6)		Class 5		Class 4		Class 4		Normal Class Class 6X		(Class 6)		Class 5		Class 4		Normal Class Class 6X		(Class 6)		Class 5		Class 4		
	over	incl.	high	low	high	low	high	low	high	low	high	low	Max.	Max.	Max.	Max.	Max.	Max.	Max.	Max.	Max.	Max.	Max.	Max.	Max.	Max.	
18 ⁽¹⁾	30	0	-12	0	-8	0	-8	0	-6	0	-6	12	8	6	5	9	6	5	4	16	11	8	7	16	11	8	7
30	50	0	-14	0	-9	0	-9	0	-7	0	-7	14	9	7	5	11	7	5	5	16	11	8	7	16	11	8	7
50	80	0	-16	0	-11	0	-11	0	-9	0	-9	16	11	8	7	12	8	6	5	16	11	8	7	16	11	8	7
80	120	0	-18	0	-13	0	-13	0	-10	0	-10	18	13	10	8	14	10	7	5	20	15	11	8	20	15	11	8
120	150	0	-20	0	-15	0	-15	0	-11	0	-11	20	15	11	8	15	11	8	6	25	18	14	10	25	18	14	10
150	180	0	-25	0	-18	0	-18	0	-13	0	-13	25	18	14	10	19	14	9	7	25	18	14	10	25	18	14	10
180	250	0	-30	0	-20	0	-20	0	-15	0	-15	30	20	15	11	23	15	10	8	40	28	22	15	40	28	22	15
250	315	0	-35	0	-25	0	-25	0	-18	0	-18	35	25	19	14	26	19	13	9	40	28	22	15	40	28	22	15
315	400	0	-40	0	-28	0	-28	0	-20	0	-20	40	28	22	15	30	21	14	10	40	28	22	15	40	28	22	15
400	500	0	-45	0	-33	0	-33	0	-25	0	-25	45	33	26	19	34	25	17	10	45	33	26	19	45	33	26	19
500	630	0	-50	0	-38	0	-38	0	-30	0	-30	60	40	30	22	38	28	20	12	60	40	30	22	60	40	30	22
630	800	0	-75	0	-55	0	-55	0	-45	0	-45	80	55	40	28	55	40	25	15	80	55	40	28	80	55	40	28
800	1000	0	-100	0	-75	0	-75	0	-60	0	-60	100	75	55	40	75	55	30	15	100	75	55	40	100	75	55	40
1000	1250	0	-125	0	-90	0	-90	0	-70	0	-70	130	90	65	45	90	65	38	15	130	90	65	45	130	90	65	45
1250	1600	0	-160	0	-110	0	-110	0	-80	0	-80	170	110	80	55	100	80	50	15	170	110	80	55	170	110	80	55
1600	2000	0	-200	0	-140	0	-140	0	-100	0	-100	210	140	100	75	110	80	65	15	210	140	100	75	210	140	100	75
2000	2500	0	-250	0	-180	0	-180	0	-130	0	-130	265	180	130	90	120	90	70	15	265	180	130	90	265	180	130	90

Notes ⁽¹⁾ 18 mm is included in this group.

⁽²⁾ Not applicable to bearings with flanges.

- Remarks 1. The outside diameter "no-go side" tolerances (low) specified in this table do not necessarily apply within a distance from the ring face to 1.2 times the chamfer dimension *r* (max.).
 2. Some of these tolerances conform to NSK standards.

Units : m

Normal Class Class 6X	K_{ra}				S_d		S_{ra}
	(Class 6)	Class 5	Class 4	Class 5	Class 4	Class 4	
	Max.	Max.	Max.	Max.	Max.	Max.	
15	7	5	3	7	3	3	
18	8	5	3	8	4	4	
20	10	6	4	8	4	4	
25	10	7	4	8	5	4	
30	13	8	5	9	5	5	
35	18	11	6	10	6	7	
50	20	13	8	11	7	8	
60	—	13	9	13	8	9	
70	—	15	—	15	—	—	
80	—	20	—	17	—	—	
90	—	25	—	20	—	—	
100	—	30	—	25	—	—	
115	—	37	—	30	—	—	
130	—	45	—	40	—	—	
150	—	55	—	50	—	—	
170	—	—	—	—	—	—	

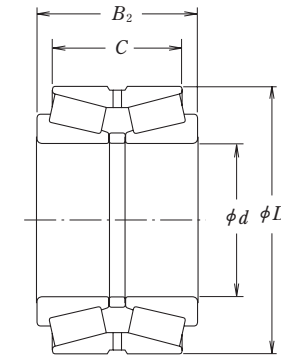
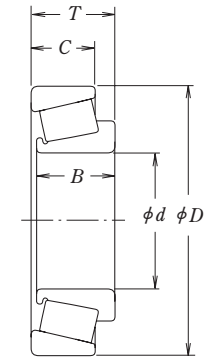

Units : m

Normal Class Class 6X	K_{ra}				$S_d^{(2)}$		$S_{ra}^{(2)}$
	(Class 6)	Class 5	Class 4	Class 5	Class 4	Class 4	
	Max.	Max.	Max.	Max.	Max.	Max.	
18	9	6	4	8	4	5	
20	10	7	5	8	4	5	
25	13	8	5	8	4	5	
35	18	10	6	9	5	6	
40	20	11	7	10	5	7	
45	23	13	8	10	5	8	
50	25	15	10	11	7	10	
60	30	18	11	13	8	10	
70	35	20	13	13	10	13	
80	—	24	—	17	—	—	
100	—	30	—	20	—	—	
120	—	36	—	25	—	—	
140	—	43	—	30	—	—	
160	—	52	—	38	—	—	
180	—	62	—	50	—	—	
200	—	73	—	65	—	—	
220	—	—	—	—	—	—	

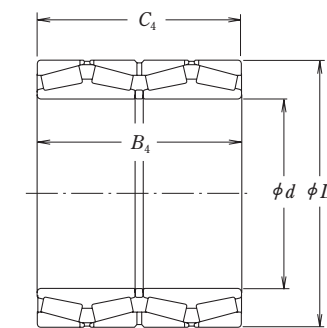

Table 7. 4 Tolerances for Inch Series Tapered Roller Bearings

(Refer to Page A126 Table 7.1 for more information on "CLASS **" ANSI/ABMA tolerances.)

Table 7. 4. 1 Tolerances for Inner Ring Bore Diameter

Units : m

Nominal Bore Diameter d				Δ_{ds}					
over		incl.		CLASS 4, 2		CLASS 3, 0		CLASS 00	
(mm)	1/25.4	(mm)	1/25.4	high	low	high	low	high	low
—	—	76.200	3.0000	+ 13	0	+13	0	+8	0
76.200	3.0000	266.700	10.5000	+ 25	0	+13	0	+8	0
	10.5000	304.800	12.0000	+ 25	0	+13	0	—	—
304.800	12.0000	609.600	24.0000	+ 51	0	+25	0	—	—
609.600	24.0000	914.400	36.0000	+ 76	0	+38	0	—	—
914.400	36.0000	1 219.200	48.0000	+102	0	+51	0	—	—
1 219.200	48.0000	—	—	+127	0	+76	0	—	—

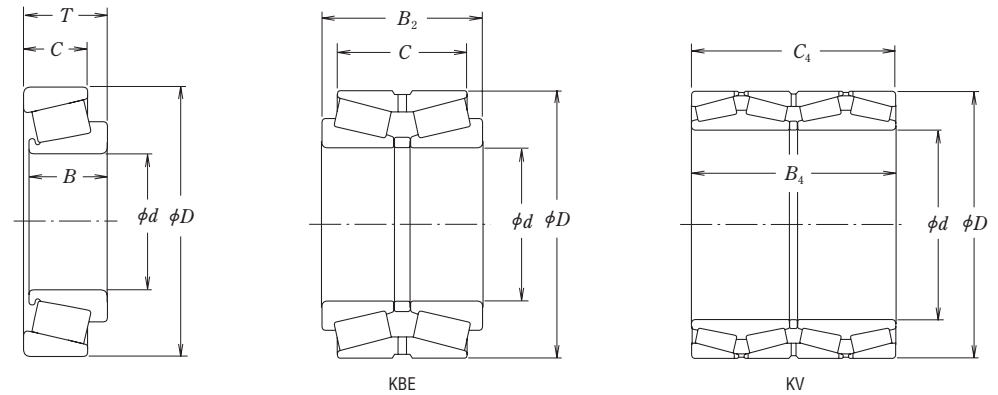

Table 7. 4. 2 Tolerances for Outer Ring Outside Diameter

Nominal Outside Diameter D				Δ_{Ds}					
over		incl.		CLASS 4, 2		CLASS 3, 0		CLASS 00	
(mm)	1/25.4	(mm)	1/25.4	high	low	high	low	high	low
—	—	266.700	10.5000	+ 25	0	+13	0	+8	0
266.700	10.5000	304.800	12.0000	+ 25	0	+13	0	+8	0
304.800	12.0000	609.600	24.0000	+ 51	0	+25	0	—	—
609.600	24.0000	914.400	36.0000	+ 76	0	+38	0	—	—
914.400	36.0000	1 219.200	48.0000	+102	0	+51	0	—	—
1 219.200	48.0000	—	—	+127	0	+76	0	—	—

and Radial Runout of Inner and Outer Rings

Units : m

K_{ia}, K_{ea}				
CLASS 4	CLASS 2	CLASS 3	CLASS 0	CLASS 00
max.	max.	max.	max.	max.
51	38	8	4	2
51	38	8	4	2
51	38	18	—	—
76	51	51	—	—
76	—	76	—	—
76	—	76	—	—

Table 7. 4. 3 Tolerances for

Nominal Bore Diameter d				Δ_{Ts}									
over		incl.		CLASS 4		CLASS 2		CLASS 3				CLASS 0, 00	
								$D \leq 508.000$ (mm)				$D > 508.000$ (mm)	
(mm)	1/25.4	(mm)	1/25.4	high	low	high	low	high	low	high	low	high	low
—	—	101.600	4.0000	+203	0	+203	0	+203	-203	+203	-203	+203	-203
101.600	4.0000	304.800	12.0000	+356	-254	+203	0	+203	-203	+203	-203	+203	-203
304.800	12.0000	609.600	24.0000	+381	-381	+381	-381	+203	-203	+381	-381	—	—
609.600	24.0000	—	—	+381	-381	—	—	+381	-381	+381	-381	—	—

Overall Width and Combined Width

Units : m

Double-Row Bearings (KBE Type)										Four-Row Bearings (KV Type)	
Δ_{B2s}										$\Delta_{B4s}, \Delta_{C4s}$	
CLASS 4		CLASS 2		CLASS 3				CLASS 0,00		CLASS 4, 3	
				$D \leq 508.000$ (mm)				$D > 508.000$ (mm)			
high	low	high	low	high	low	high	low	high	low	high	low
+406	0	+406	0	+406	-406	+406	-406	+406	-406	+1 524	-1 524
+711	-508	+406	-203	+406	-406	+406	-406	+406	-406	+1 524	-1 524
+762	-762	+762	-762	+406	-406	+762	-762	—	—	+1 524	-1 524
+762	-762	—	—	+762	-762	+762	-762	—	—	+1 524	-1 524

Table 7. 5 Tolerances
Table 7. 5. 1 Tolerances for Inner Rings

Nominal Bore Diameter <i>d</i> (mm)		Δ_{dmp}						V_{dp}			V_{dmp}			Δ_{Bs} (or Δ_{Cs}) ⁽¹⁾			
		Normal		Class 6		Class 5		Normal	Class 6	Class 5	Normal	Class 6	Class 5	Normal Class 6		Class 5	
over	incl.	high	low	high	low	high	low	max.	max.	max.	max.	max.	max.	high	low	high	low
2.5	10	0	-8	0	-7	0	-5	6	5	4	6	5	3	0	-120	0	-40
10	18	0	-8	0	-7	0	-5	6	5	4	6	5	3	0	-120	0	-80
18	30	0	-10	0	-8	0	-6	8	6	5	8	6	3	0	-120	0	-120

Note ⁽¹⁾ The actual width deviation and width variation of an outer ring is determined according to the inner ring of the same bearing.

Remark The bore diameter "no-go side" tolerances (high) specified in this table do not necessarily apply within a distance from the ring face to 1.2 times the chamfer dimension *r* (max.).

Table 7. 5. 2 Tolerances

Nominal Outside Diameter <i>D</i> (mm)		Δ_{Dmp}											V_{Dp}			
		Bearing Series E						Bearing Series EN					Normal	Class 6	Class 5	
		Normal		Class 6		Class 5		Normal		Class 6		Class 5				
over	incl.	high	low	high	low	high	low	high	low	high	low	high	low	max.	max.	max.
6	18	+8	0	+7	0	+5	0	0	-8	0	-7	0	-5	6	5	4
18	30	+9	0	+8	0	+6	0	0	-9	0	-8	0	-6	7	6	5
30	50	+11	0	+9	0	+7	0	0	-11	0	-9	0	-7	8	7	5

Remark The outside diameter "no-go side" tolerances (low) do not necessarily apply within a distance from the ring face to 1.2 times the chamfer dimension *r* (max.).

for Magneto Bearings and Width of Outer Rings

Units : m

V_{Bs} (or V_{Cs}) ⁽¹⁾		Δ_{Ts}		K_{ia}			S_d	S_{ia}
		Normal Class 6	Class 5	Normal	Class 6	Class 5	Class 5	Class 5
max.	max.	high	low	max.	max.	max.	max.	max.
15	5	+120	-120	10	6	4	7	7
20	5	+120	-120	10	7	4	7	7
20	5	+120	-120	13	8	4	8	8

for Outer Rings

Units : m

V_{Dmp}			K_{ea}			S_{ea}	S_D
Normal	Class 6	Class 5	Normal	Class 6	Class 5	Class 5	Class 5
max.	max.	max.	max.	max.	max.	max.	max.
6	5	3	15	8	5	8	8
7	6	3	15	9	6	8	8
8	7	4	20	10	7	8	8

Table 7. 6 Tolerances for Thrust Ball Bearings

Table 7. 6. 1 Tolerances for Shaft Washer Bore Diameter and Running Accuracy

Units : m

Nominal Bore Diameter d or d_2 (mm)		Δd_{mp} or Δd_{2mp}				$V_{d_{sp}}$ or $V_{d_{2sp}}$		S_i or S_e (1)			
								Normal Class 6 Class 5	Class 4		Normal Class 6 Class 5
		over	incl.	high	low	high	low	max.	max.	max.	max.
—	18	0	- 8	0	- 7	6	5	10	5	3	2
18	30	0	- 10	0	- 8	8	6	10	5	3	2
30	50	0	- 12	0	-10	9	8	10	6	3	2
50	80	0	- 15	0	-12	11	9	10	7	4	3
80	120	0	- 20	0	-15	15	11	15	8	4	3
120	180	0	- 25	0	-18	19	14	15	9	5	4
180	250	0	- 30	0	-22	23	17	20	10	5	4
250	315	0	- 35	0	-25	26	19	25	13	7	5
315	400	0	- 40	0	-30	30	23	30	15	7	5
400	500	0	- 45	0	-35	34	26	30	18	9	6
500	630	0	- 50	0	-40	38	30	35	21	11	7
630	800	0	- 75	0	-50	—	—	40	25	13	8
800	1 000	0	-100	—	—	—	—	45	30	15	—
1 000	1 250	0	-125	—	—	—	—	50	35	18	—

Note (1) For double-direction bearings, the thickness variation does not depend on the bore diameter d_2 , but rather on d for single-direction bearings with the same D in the same Diameter Series.
The thickness variation of housing washers S_e applies only to flat-seat thrust bearings.

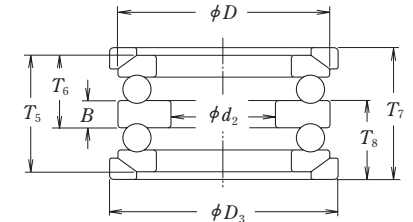
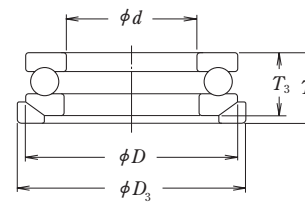
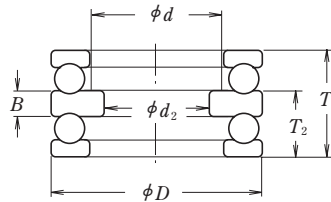
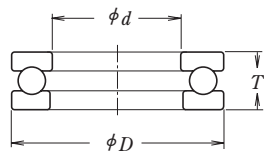

Table 7. 6. 2 Tolerances for Outside Diameter of Housing Washers and Aligning Seat Washers

Units : m

Nominal Outside Diameter of Bearing or Aligning Seat Washer D or D_3 (mm)		ΔD_{mp}						$V_{D_{sp}}$		Aligning Seat Washer Outside Diameter Deviation ΔD_{3s}	
		Flat Seat Type				Aligning Seat Washer Type					
		over	incl.	high	low	high	low	high	low	max.	max.
10	18	0	- 11	0	- 7	0	- 17	8	5	0	- 25
18	30	0	- 13	0	- 8	0	- 20	10	6	0	- 30
30	50	0	- 16	0	- 9	0	- 24	12	7	0	- 35
50	80	0	- 19	0	-11	0	- 29	14	8	0	- 45
80	120	0	- 22	0	-13	0	- 33	17	10	0	- 60
120	180	0	- 25	0	-15	0	- 38	19	11	0	- 75
180	250	0	- 30	0	-20	0	- 45	23	15	0	- 90
250	315	0	- 35	0	-25	0	- 53	26	19	0	-105
315	400	0	- 40	0	-28	0	- 60	30	21	0	-120
400	500	0	- 45	0	-33	0	- 68	34	25	0	-135
500	630	0	- 50	0	-38	0	- 75	38	29	0	-180
630	800	0	- 75	0	-45	0	-113	55	34	0	-225
800	1 000	0	-100	—	—	—	—	75	—	—	—
1 000	1 250	0	-125	—	—	—	—	—	—	—	—
1 250	1 600	0	-160	—	—	—	—	—	—	—	—

Table 7. 6. 3 Tolerances for Thrust Ball Bearing Height and Central Washer Height

Units : m

Nominal Bore Diameter d ⁽¹⁾ (mm)	Flat Seat Type				Aligning Seat Washer Type				With Aligning Seat Washer				Height Deviation of Central Washer Δ_{Bs}		
	$\Delta_{T_{2s}}$ or $\Delta_{T_{2s}}$		$\Delta_{T_{1s}}$		$\Delta_{T_{3s}}$ or $\Delta_{T_{3s}}$		$\Delta_{T_{3s}}$		$\Delta_{T_{4s}}$ or $\Delta_{T_{3s}}$		$\Delta_{T_{7s}}$		Normal, Class 6 Class 5, Class 4		
	over	incl.	high	low	high	low	high	low	high	low	high	low	high	low	
—	30	0	-75	+50	-150	0	-75	+50	-150	+50	-75	+150	-150	0	-50
30	50	0	-100	+75	-200	0	-100	+75	-200	+50	-100	+175	-200	0	-75
50	80	0	-125	+100	-250	0	-125	+100	-250	+75	-125	+250	-250	0	-100
80	120	0	-150	+125	-300	0	-150	+125	-300	+75	-150	+275	-300	0	-125
120	180	0	-175	+150	-350	0	-175	+150	-350	+100	-175	+350	-350	0	-150
180	250	0	-200	+175	-400	0	-200	+175	-400	+100	-200	+375	-400	0	-175
250	315	0	-225	+200	-450	0	-225	+200	-450	+125	-225	+450	-450	0	-200
315	400	0	-300	+250	-600	0	-300	+250	-600	+150	-275	+550	-550	0	-250

Note ⁽¹⁾ For double-direction bearings, classification depends on d for single-direction bearings with the same D in the same Diameter Series.

Remark Δ_{T_s} in the table is the deviation in the respective heights T in the figures below.

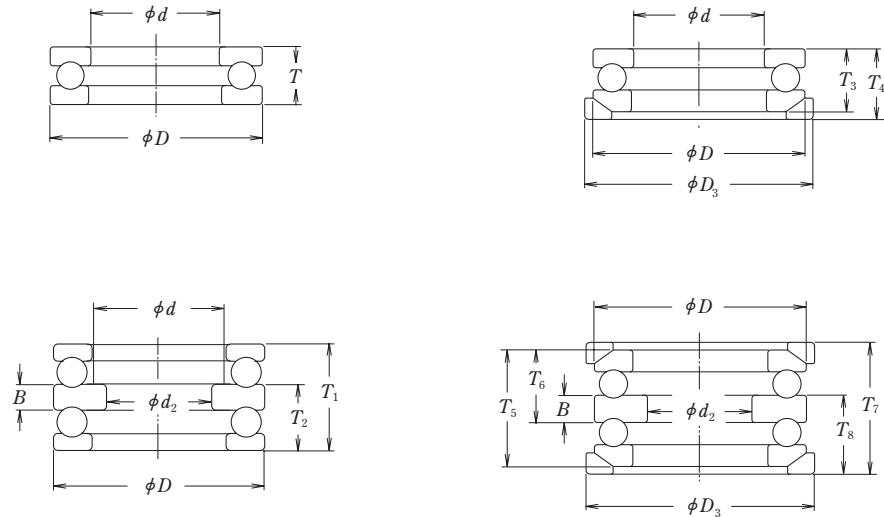

Table 7. 7 Tolerances for Tapered Roller Thrust Bearings

Table 7. 7. 1 Tolerances for Bore Diameters of Shaft Washers and Height (Metric, Normal Class) Units : m

Nominal Bore Diameter d (mm)		$\Delta_{d_{mp}}$		Δ_{T_s}	
over	incl.	high	low	high	low
80	120	0	-20	0	-150
120	180	0	-25	0	-175
180	250	0	-30	0	-200
250	315	0	-35	0	-225
315	400	0	-40	0	-300
400	500	0	-45	0	-350
500	630	0	-50	0	-450
630	800	0	-75	0	-550
800	1 000	0	-100	0	-700
1 000	1 250	0	-125	0	-900
1 250	1 600	0	-160	0	-1 200

Table 7. 7. 2 Tolerances for Housing Washer Outside Diameters (Metric, Normal Class) Units : m

Nominal Outside Diameter D (mm)		$\Delta_{D_{mp}}$	
over	incl.	high	low
180	250	0	-30
250	315	0	-35
315	400	0	-40
400	500	0	-45
500	630	0	-50
630	800	0	-75
800	1 000	0	-100
1 000	1 250	0	-125
1 250	1 600	0	-160
1 600	2 000	0	-200

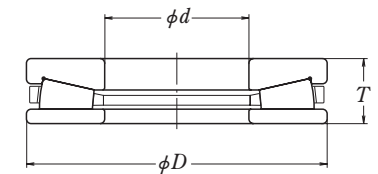
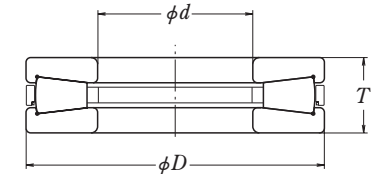

Table 7. 7 Tolerances for Tapered Roller Thrust Bearings

Table 7. 7. 3 Tolerances for Bore Diameters of Shaft Washers and Height (Inch, Class 4) Units : m

Nominal Bore Diameter d				Δd_{mp}		ΔT_s	
over		incl		high	low	high	low
(mm)	(inch)	(mm)	(inch)				
—	—	304.800	12.0000	+25	0	+381	-381
304.800	12.0000	609.600	24.0000	+51	0	+381	-381
609.600	24.0000	914.400	36.0000	+76	0	+381	-381
914.400	36.0000	1 219.200	48.0000	+102	0	+381	-381

Table 7. 7. 4 Tolerances for Housing Washer Outside Diameters (Inch, Class 4) Units : m

Nominal Outside Diameter D				ΔD_{mp}	
over		incl		high	low
(mm)	(inch)	(mm)	(inch)		
—	—	304.800	12.0000	+25	0
304.800	12.0000	609.600	24.0000	+51	0
609.600	24.0000	914.400	36.0000	+76	0
914.400	36.0000	1 219.200	48.0000	+102	0
1 219.200	48.0000	—	—	+127	0

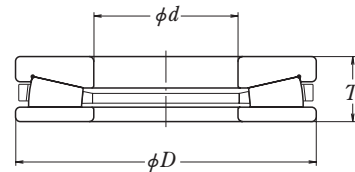
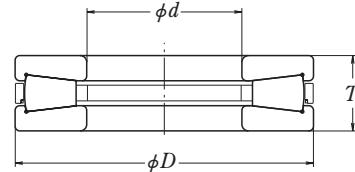

Table 7. 8 Tolerances for Thrust Spherical Roller Bearings

Table 7. 8. 1 Tolerances for Bore Diameters of Shaft Rings and Height (Normal Class) Units : m

Nominal Bore Diameter d (mm)		Δd_{mp}		V_{dsp}	Reference		
over	incl.	high	low	max.	S_d max.	ΔT_s	
						high	low
50	80	0	-15	11	25	+150	-150
80	120	0	-20	15	25	+200	-200
120	180	0	-25	19	30	+250	-250
180	250	0	-30	23	30	+300	-300
250	315	0	-35	26	35	+350	-350
315	400	0	-40	30	40	+400	-400
400	500	0	-45	34	45	+450	-450

Remark The bore diameter "no-go side" tolerances (high) specified in this table do not necessarily apply within a distance from the ring face to 1.2 times the chamfer dimension r (max.).

Table 7. 8. 2 Tolerances for Housing Ring Diameter (Normal Class) Units : m

Nominal Outside Diameter D (mm)		ΔD_{mp}	
over	incl.	high	low
120	180	0	- 25
180	250	0	- 30
250	315	0	- 35
315	400	0	- 40
400	500	0	- 45
500	630	0	- 50
630	800	0	- 75
800	1 000	0	-100

Remark The outside diameter "no-go side" tolerances (low) specified in this table do not necessarily apply within a distance from the ring face to 1.2 times the chamfer dimension r (max.).

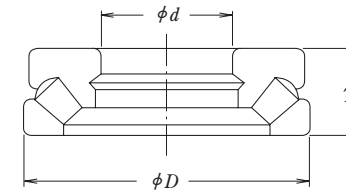

Table 7. 9 Tolerances of CLASS 5P, CLASS 7P, and CLASS 9P

(1) Tolerances for Inner Rings

Nominal Bore Diameter <i>d</i> (mm)		Δ_{dmp}				Δ_{ds}				V_{dp}		V_{dmp}		Δ_{Bs}	
		CLASS 5P CLASS 7P		CLASS 9P		CLASS 5P CLASS 7P		CLASS 9P		CLASS 5P CLASS 7P	CLASS 9P	CLASS 5P CLASS 7P	CLASS 9P	Single Brgs	
		high	low	high	low	high	low	high	low	max.	max.	max.	max.	high	low
over	incl.	0	-5.1	0	-2.5	0	-5.1	0	-2.5	2.5	1.3	2.5	1.3	0	-25.4
—	10	0	-5.1	0	-2.5	0	-5.1	0	-2.5	2.5	1.3	2.5	1.3	0	-25.4
10	18	0	-5.1	0	-2.5	0	-5.1	0	-2.5	2.5	1.3	2.5	1.3	0	-25.4
18	30	0	-5.1	0	-2.5	0	-5.1	0	-2.5	2.5	1.3	2.5	1.3	0	-25.4

Note (1) Applicable to bearings for which the axial clearance (preload) is to be adjusted by combining two selected bearings.
Remark Please consult with NSK regarding CLASS 3P and the tolerances of Metric Series instrument ball bearings.

(2) Tolerances for

Nominal Outside Diameter <i>D</i> (mm)		Δ_{Dmp}				Δ_{Ds}				V_{Dp}			V_{Dmp}				
		CLASS 5P CLASS 7P		CLASS 9P		CLASS 5P CLASS 7P		CLASS 9P		CLASS 5P CLASS 7P	CLASS 9P	CLASS 5P CLASS 7P	CLASS 9P	CLASS 5P CLASS 7P	CLASS 9P		
		high	low	high	low	high	low	high	low	Open	Shielded Sealed	Open	Open	Shielded Sealed	Open		
over	incl.	0	-5.1	0	-2.5	0	-5.1	+1	-6.1	0	-2.5	2.5	5.1	1.3	2.5	5.1	1.3
—	18	0	-5.1	0	-2.5	0	-5.1	+1	-6.1	0	-2.5	2.5	5.1	1.3	2.5	5.1	1.3
18	30	0	-5.1	0	-3.8	0	-5.1	+1	-6.1	0	-3.8	2.5	5.1	2	2.5	5.1	2
30	50	0	-5.1	0	-3.8	0	-5.1	+1	-6.1	0	-3.8	2.5	5.1	2	2.5	5.1	2

Notes (1) Applicable to flange width variation for flanged bearings.
 (2) Applicable to the flange back face.

Instrument Ball Bearings (Inch Series) (ANSI/ABMA Equivalent)

and Width of Outer Rings

Units : m

(or Δ_{Cs})		V_{Bs}			K_{ia}			S_{ia}			S_d		
Combined Brgs (1)		CLASS 5P	CLASS 7P	CLASS 9P	CLASS 5P	CLASS 7P	CLASS 9P	CLASS 5P	CLASS 7P	CLASS 9P	CLASS 5P	CLASS 7P	CLASS 9P
high	low	max.	max.	max.	max.	max.	max.	max.	max.	max.	max.	max.	max.
0	-400	5.1	2.5	1.3	3.8	2.5	1.3	7.6	2.5	1.3	7.6	2.5	1.3
0	-400	5.1	2.5	1.3	3.8	2.5	1.3	7.6	2.5	1.3	7.6	2.5	1.3
0	-400	5.1	2.5	1.3	3.8	3.8	2.5	7.6	3.8	1.3	7.6	3.8	1.3

Outer Rings

Units : m

V_{Cs} (1)			S_D			K_{ea}			S_{ea}			Deviation of Flange Outside Diameter $\Delta_{D_{is}}$		Deviation of Flange Width $\Delta_{C_{is}}$		Flange Backface Runout with Raceway (2) S_{ea1}
CLASS 5P	CLASS 7P	CLASS 9P	CLASS 5P	CLASS 7P	CLASS 9P	CLASS 5P	CLASS 7P	CLASS 9P	CLASS 5P	CLASS 7P	CLASS 9P	CLASS 5P CLASS 7P	CLASS 5P CLASS 7P	CLASS 5P CLASS 7P	CLASS 5P CLASS 7P	CLASS 5P CLASS 7P
max.	max.	max.	max.	max.	max.	max.	max.	max.	max.	max.	max.	high	low	high	low	max.
5.1	2.5	1.3	7.6	3.8	1.3	5.1	3.8	1.3	7.6	5.1	1.3	0	-25.4	0	-50.8	7.6
5.1	2.5	1.3	7.6	3.8	1.3	5.1	3.8	2.5	7.6	5.1	2.5	0	-25.4	0	-50.8	7.6
5.1	2.5	1.3	7.6	3.8	1.3	5.1	5.1	2.5	7.6	5.1	2.5	0	-25.4	0	-50.8	7.6

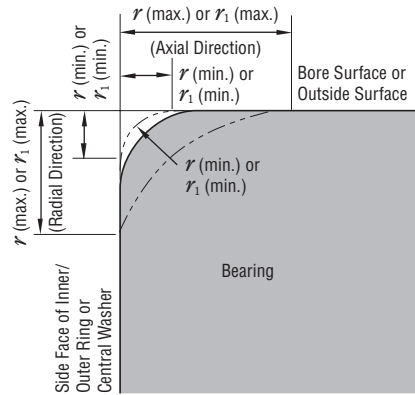

r : Chamfer dimension of inner/outer ring
 r_1 : Chamfer dimension of inner/outer ring (front side) or of central washer of thrust ball bearings

Remark The precise shape of chamfer surfaces has not been specified but its profile in the axial plane must not intersect an arc of radius r (min.) or r_1 (min.) that touches the side face of an inner ring or central washer and bore surface or the side face of an outer ring and outside surface.

Table 7. 10 Chamfer Dimension Limits (for Metric Series Bearings)

Table 7. 10. 1 Chamfer Dimension Limits for Radial Bearings (Excluding Tapered Roller Bearings)
Units : mm

Permissible Chamfer Dimension for Inner/Outer Rings r (min.) or r_1 (min.)	Nominal Bore Diameter d		Permissible Chamfer Dimension for Inner/Outer Rings r (max.) or r_1 (max.)		Reference
	over	incl.	Radial Direction	Axial Direction ⁽¹⁾	Corner Radius of Shaft or Housing r_a max.
0.05	—	—	0.1	0.2	0.05
0.08	—	—	0.16	0.3	0.08
0.1	—	—	0.2	0.4	0.1
0.15	—	—	0.3	0.6	0.15
0.2	—	—	0.5	0.8	0.2
0.3	—	40	0.6	1	0.3
	40	—	0.8	1	
0.6	—	40	1	2	0.6
	40	—	1.3	2	
1	—	50	1.5	3	1
	50	—	1.9	3	
1.1	—	120	2	3.5	1
	120	—	2.5	4	
1.5	—	120	2.3	4	1.5
	120	—	3	5	
2	—	80	3	4.5	2
	80	220	3.5	5	
	220	—	3.8	6	
2.1	—	280	4	6.5	2
	280	—	4.5	7	
2.5	—	100	3.8	6	2
	100	280	4.5	6	
	280	—	5	7	
3	—	280	5	8	2.5
	280	—	5.5	8	
4	—	—	6.5	9	3
5	—	—	8	10	4
6	—	—	10	13	5
7.5	—	—	12.5	17	6
9.5	—	—	15	19	8
12	—	—	18	24	10
15	—	—	21	30	12
19	—	—	25	38	15

Note ⁽¹⁾ For bearings with nominal widths less than 2 mm, the value of r (max.) in the axial direction is the same as that in the radial direction.

Table 7. 10. 2 Chamfer Dimension Limits for Tapered Roller Bearings
Units : mm

Permissible Chamfer Dimension for Inner/Outer Rings r (min.)	Nominal Bore or Nominal Outside Diameter ⁽¹⁾ d or D		Permissible Chamfer Dimension for Inner/Outer Rings r (max.)		Reference
	over	incl.	Radial Direction	Axial Direction	Corner Radius of Shaft or Housing r_a max.
0.15	—	—	0.3	0.6	0.15
0.3	—	40	0.7	1.4	0.3
	40	—	0.9	1.6	
0.6	—	40	1.1	1.7	0.6
	40	—	1.3	2	
1	—	50	1.6	2.5	1
	50	—	1.9	3	
1.5	—	120	2.3	3	1.5
	120	250	2.8	3.5	
	250	—	3.5	4	
2	—	120	2.8	4	2
	120	250	3.5	4.5	
	250	—	4	5	
2.5	—	120	3.5	5	2
	120	250	4	5.5	
	250	—	4.5	6	
3	—	120	4	5.5	2.5
	120	250	4.5	6.5	
	250	400	5	7	
	400	—	5.5	7.5	
4	—	120	5	7	3
	120	250	5.5	7.5	
	250	400	6	8	
	400	—	6.5	8.5	
5	—	180	6.5	8	4
	180	—	7.5	9	
6	—	180	7.5	10	5
	180	—	9	11	

Note ⁽¹⁾ Inner rings are classified by d and outer rings by D .

Table 7. 10. 3 Chamfer Dimension Limits for Thrust Bearings
Units : mm

Permissible Chamfer Dimension for Shaft (or Central)/Housing Washers r (min.) or r_1 (min.)	Permissible Chamfer Dimension for Shaft (or Central)/Housing Washers r (max.) or r_1 (max.)		Reference
	Radial and Axial Direction		Corner Radius of Shaft or Housing r_a max.
0.05	0.1	0.05	
0.08	0.16	0.08	
0.1	0.2	0.1	
0.15	0.3	0.15	
0.2	0.5	0.2	
0.3	0.8	0.3	
0.6	1.5	0.6	
1	2.2	1	
1.1	2.7	1	
1.5	3.5	1.5	
2	4	2	
2.1	4.5	2	
3	5.5	2.5	
4	6.5	3	
5	8	4	
6	10	5	
7.5	12.5	6	
9.5	15	8	
12	18	10	
15	21	12	
19	25	15	

Table 7.11 Tolerances for Tapered Bores (Normal Class)

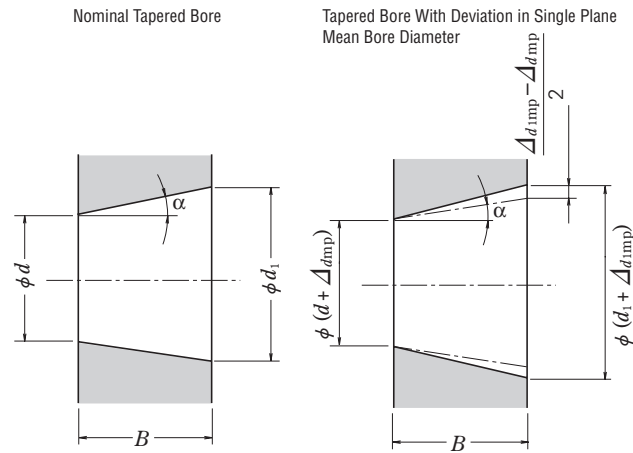

d : Nominal bore diameter
 d_1 : Theoretical diameter of larger end of tapered bore
 Taper 1:12 $d_1 = d + 1/12 B$ Taper 1:30 $d_1 = d + /30 B$
 Δ_{dmp} : Single plane mean bore diameter deviation in theoretical diameter of smaller end of bore
 Δ_{d1mp} : Single plane mean bore diameter deviation in theoretical diameter of larger end of bore
 V_{dp} : Bore diameter variation in a single radial plane
 B : Nominal inner ring width
 α : Half of taper angle of tapered bore

Taper 1:12 Taper 1:30
 $\alpha = 2^\circ 23' 9.4''$ $\alpha = 57' 17.4''$
 $= 2.38594^\circ$ $= 0.95484^\circ$
 $= 0.041643 \text{ rad}$ $= 0.016665 \text{ rad}$

Taper 1 : 12

Units : μm

Nominal Bore Diameter d (mm)		Δ_{dmp}		$\Delta_{d1mp} - \Delta_{dmp}$		V_{dp} ⁽¹⁾ ⁽²⁾
over	incl.	high	low	high	low	max.
18	30	+33	0	+21	0	13
30	50	+39	0	+25	0	16
50	80	+46	0	+30	0	19
80	120	+54	0	+35	0	22
120	180	+63	0	+40	0	40
180	250	+72	0	+46	0	46
250	315	+81	0	+52	0	52
315	400	+89	0	+57	0	57
400	500	+97	0	+63	0	63
500	630	+110	0	+70	0	70
630	800	+125	0	+80	0	—
800	1 000	+140	0	+90	0	—
1 000	1 250	+165	0	+105	0	—
1 250	1 600	+195	0	+125	0	—

Notes ⁽¹⁾ Applicable to all radial planes of tapered bores.
⁽²⁾ Not applicable to Diameter Series 7 and 8.

Taper 1 : 30

Units : m

Nominal Bore Diameter d (mm)		Δ_{dmp}		$\Delta_{d1mp} - \Delta_{dmp}$		V_{dp} ⁽¹⁾ ⁽²⁾
over	incl.	high	low	high	low	max.
80	120	+20	0	+35	0	22
120	180	+25	0	+40	0	40
180	250	+30	0	+46	0	46
250	315	+35	0	+52	0	52
315	400	+40	0	+57	0	57
400	500	+45	0	+63	0	63
500	630	+50	0	+70	0	70

Notes ⁽¹⁾ Applicable to all radial planes of tapered bores.

⁽²⁾ Not applicable to diameter series 7 and 8.

Remark For a value exceeding 630 mm, please contact NSK.

7.2 Selection of Tolerance Classes

For general applications, Normal Class tolerances are adequate in nearly all cases for satisfactory performance. However, bearings with Class 5, 4, or higher tolerances are more suitable for the following applications in Table 7.12.

Example reference applications and appropriate tolerance classes are listed for various bearing requirements and operating conditions.

Table 7.12 Typical Tolerance Classes for Specific Applications (Reference)

Bearing Requirements, Operating Conditions	Example Applications	Tolerance Classes
High Running Accuracy	VTR Drum Spindles	P5
	Magnetic Disk Spindles for Computers	P5, P4, P2
	Machine-Tool Main Spindles	P5, P4, P2
	Rotary Printing Presses	P5
	Rotary Tables of Vertical Presses, etc.	P5, P4
	Roll Necks of Cold Rolling Mill Backup Rolls	Higher than P4
Extra High Speed	Slewing Bearings for Parabolic Antennas	Higher than P4
	Dental Drills	CLASS 7P, CLASS 5P
	Gyroscopes	CLASS 7P, P4
	High Frequency Spindles	CLASS 7P, P4
	Superchargers	P5, P4
	Centrifugal Separators	P5, P4
Low Torque and Low Torque Variation	Main Shafts of Jet Engines	Higher than P4
	Gyroscope Gimbals	CLASS 7P, P4
	Servomechanisms	CLASS 7P, CLASS 5P
Potentiometric Controllers	CLASS 7P	

8. FITS AND INTERNAL CLEARANCES

8.1 Fits	A 154
8.1.1 Importance of Proper Fits	A 154
8.1.2 Selection of Fit	A 154
(1) Load Conditions and Fit	A 154
(2) Magnitude of Load and Interference	A 154
(3) Interference Variation Caused by Temperature Differences Between Bearing and Shaft or Housing	A 156
(4) Effective Interference and Finish of Shaft and Housing	A 156
(5) Fitting Stress and Ring Expansion and Contraction	A 156
(6) Surface Pressure and Maximum Stress on Fitting Surface	A 158
(7) Mounting and Withdrawal Loads	A 160
8.1.3 Recommended Fits	A 162
8.2 Bearing Internal Clearances	A 168
8.2.1 Internal Clearances and Their Standards	A 168
8.2.2 Selection of Bearing Internal Clearances	A 174
(1) Decrease in Radial Clearance Caused by Fitting and Residual Clearance	A 174
(2) Decrease in Radial Internal Clearance Caused by Temperature Differences Between Inner and Outer Rings and Effective Clearance	A 175
8.3 Technical Data	A 176
8.3.1 Temperature Rise and Dimensional Change	A 176
8.3.2 Interference Deviation Due to Temperature Rise (Aluminum Housing, Plastic Housing)	A 178
8.3.3 Calculating Residual Internal Clearance After Mounting	A 180
8.3.4 Effect of Interference Fits on Bearing Raceways (Fit of Inner Ring)	A 182
8.3.5 Effect of Interference Fits on Bearing Raceways (Fit of Outer Ring)	A 184
8.3.6 Measuring the Internal Clearance of Combined Tapered Roller Bearings (Offset Measuring Method)	A 186
8.3.7 Internal Clearance Adjustment Method When Mounting a Tapered Roller Bearing	A 188

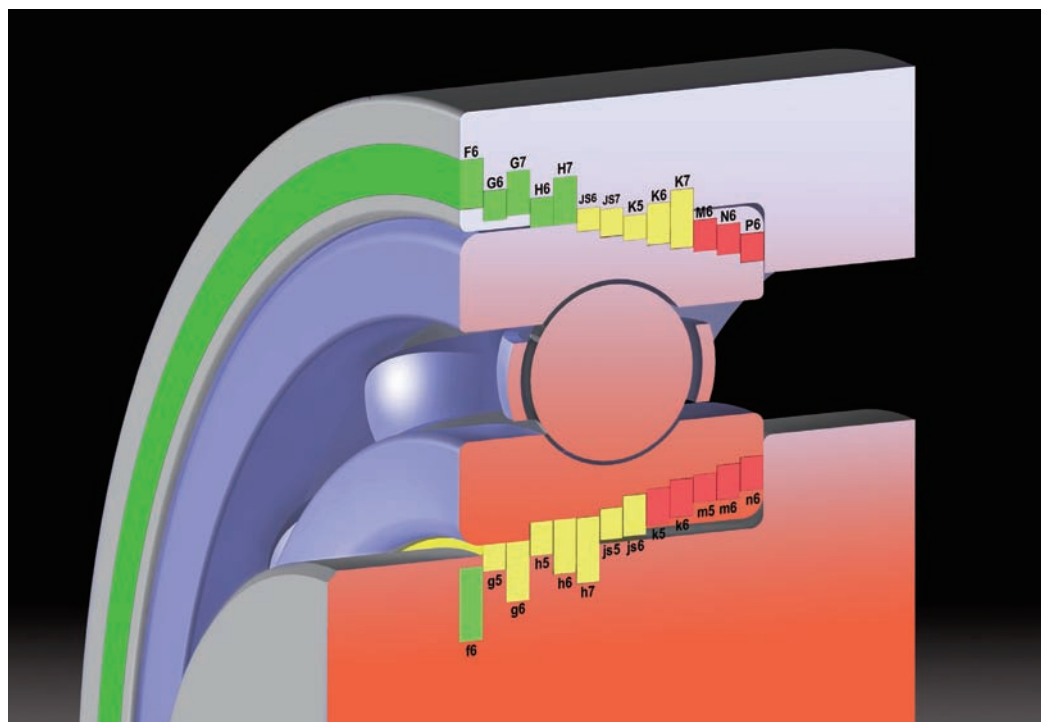

8. FITS AND INTERNAL CLEARANCES

8.1 Fits

8.1.1 Importance of Proper Fits

In cases where a rolling bearing has its inner ring fitted to the shaft with only slight interference, harmful circumferential slippage may occur between the inner ring and shaft. This slipping of the inner ring, which is called "creep", results in a circumferential displacement of the ring relative to the shaft if the interference fit is not sufficiently tight. When creep occurs, the fitted surfaces become abraded, causing wear and considerable damage to the shaft. Abnormal heating and vibration may also occur due to abrasive metallic particles entering the interior of the bearing. It is important to prevent creep by having sufficient interference to firmly secure the ring that rotates to either the shaft or housing. Creep cannot always be eliminated using only axial tightening through the bearing ring faces. Generally, it is not necessary, to provide interference for rings subjected only to stationary loads. Fits are sometimes made without any interference for either the inner or outer ring to accommodate certain operating conditions, or to facilitate mounting and dismounting. In these cases, lubrication of other applicable methods should be considered to prevent damage to the fitting surfaces due to creep.

8.1.2 Selection of Fit

(1) Load Conditions and Fit

The proper fit can be selected from Table 8.1 based on the load and operating conditions.

(2) Magnitude of Load and Interference

The interference of the inner ring is slightly reduced by bearing load; therefore, the loss of interference should be estimated using the following equations:

$$\left. \begin{aligned} \Delta d_F &= 0.08 \sqrt{\frac{d}{B}} F_r \times 10^{-3} \dots\dots (N) \\ \Delta d_F &= 0.25 \sqrt{\frac{d}{B}} F_r \times 10^{-3} \dots\dots \{kgf\} \end{aligned} \right\} \dots (8.1)$$

where Δd_F : Interference decrease of inner ring (mm)
 d : Bearing bore diameter (mm)
 B : Nominal inner ring width (mm)
 F_r : Radial load applied on bearing (N), {kgf}

Therefore, the effective interference Δd should be larger than the interference given by Equation (8.1). However, interference often becomes insufficient with heavy loads where the radial load exceeds 20% of the basic static load rating C_{or} , under normal operating conditions. In these cases, interference should be estimated using Equation (8.2):

$$\left. \begin{aligned} \Delta d &\geq 0.02 \frac{F_r}{B} \times 10^{-3} \dots\dots (N) \\ \Delta d &\geq 0.2 \frac{F_r}{B} \times 10^{-3} \dots\dots \{kgf\} \end{aligned} \right\} \dots\dots (8.2)$$

where Δd : Effective interference (mm)
 F_r : Radial load applied on bearing (N), {kgf}
 B : Nominal inner ring width (mm)

Creep experiments conducted by NSK with NU219 bearings showed a linear relation between radial load (load at creep occurrence limit) and required effective

interference. It was confirmed that this line agrees well with the straight line of Equation (8.2). When subjected to loads heavier than 0.25 C_{or} , the interference given by Equation (8.1) for NU219 bearings becomes insufficient and creep occurs. Generally speaking, the necessary interference for loads heavier than 0.25 C_{or} should be calculated using Equation (8.2). When doing this, verify that the fit does not cause excessive circumferential stress.

Calculation example

For NU219, $B = 32$ (mm) and assume
 $F_r = 98\,100$ N {10 000 kgf}
 $C_{or} = 183\,000$ N {18 600 kgf}

$$\frac{F_r}{C_{or}} = \frac{98\,100}{183\,000} = 0.536 > 0.2$$

Therefore, the required effective interference is calculated using Equation (8.2).

$$\Delta d = 0.02 \times \frac{98\,100}{32} \times 10^{-3} = 0.061 \text{ (mm)}$$

This result agrees well with Fig. 8.1.

Table 8.1 Loading Conditions and Fits

Load Application	Bearing Operation		Load Conditions	Fitting	
	Inner Ring	Outer Ring		Inner Ring	Outer Ring
	Rotating	Stationary	Rotating Inner Ring Load	Tight Fit	Loose Fit
	Stationary	Rotating	Stationary Outer Ring Load	Tight Fit	Loose Fit
	Stationary	Rotating	Rotating Outer Ring Load	Loose Fit	Tight Fit
	Rotating	Stationary	Stationary Inner Ring Load	Loose Fit	Tight Fit
Indeterminate load direction due to variation of direction or unbalanced load	Rotating or Stationary	Rotating or Stationary	Direction of Load Indeterminate	Tight Fit	Tight Fit

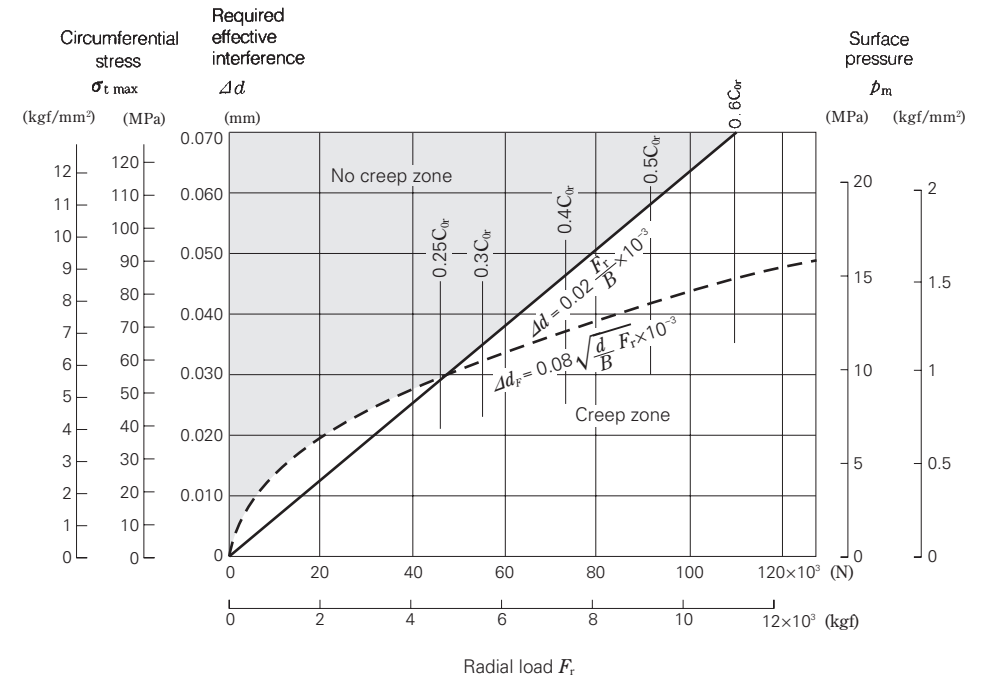

Fig. 8.1 Load and Required Effective Interference for Fit

(3) Interference Variation Caused by Temperature Differences Between Bearing and Shaft or Housing

The effective interference decreases due to the increasing bearing temperature during operation. If the temperature difference between the bearing and housing is ΔT (°C), then the temperature difference between the fitted surfaces of the shaft and inner ring is estimated to be about $(0.1-0.15) \Delta T$ when the shaft is cooled. The decrease in the interference of the inner ring due to this temperature difference Δd_T may be calculated using Equation (8.3):

$$\Delta d_T = (0.10 \text{ to } 0.15) \times \Delta T \cdot \alpha \cdot d \approx 0.0015 \Delta T \cdot d \times 10^{-3} \dots\dots\dots (8.3)$$

- where Δd_T : Decrease in interference of inner ring due to temperature difference (mm)
- ΔT : Temperature difference between bearing interior and surrounding parts (°C)
- α : Coefficient of linear expansion of bearing steel $\approx 12.5 \times 10^{-6}$ (1/°C)
- d : Bearing nominal bore diameter (mm)

In addition, depending on the temperature difference between the outer ring and housing, or difference in their coefficients of linear expansion, interference may increase.

(4) Effective Interference and Finish of Shaft and Housing

Since the roughness of fitted surfaces is reduced during fitting, the effective interference becomes less than the apparent interference. The amount of this interference decrease varies depending on the roughness of the surfaces and may be estimated using the following equations:

For ground shafts $\Delta d = \frac{d}{d+2} \Delta d_a \dots\dots\dots (8.4)$

For machined shafts $\Delta d = \frac{d}{d+3} \Delta d_a \dots\dots\dots (8.5)$

- where Δd : Effective interference (mm)
- Δd_a : Apparent interference (mm)
- d : Bearing nominal bore diameter (mm)

According to Equations (8.4) and (8.5), the effective interference of bearings with a bore diameter of 30 to 150 mm is about 95% of the apparent interference.

(5) Fitting Stress and Ring Expansion and Contraction

When bearings are mounted with interference on a shaft or in a housing, the rings either expand or contract and stress is produced. Excessive interference may damage the bearings; therefore, as a general rule, the maximum interference should be kept under approximately 7/10 000 the shaft diameter. The pressure between fitted surfaces, expansion or contraction of the rings, and circumferential stress may be calculated using the equations in Table 8.2.

Table 8.2 Fit Conditions

	Inner Ring and Shaft	Outer Ring and Housing
Surface Pressure p_m (MPa) {kgf/mm ² }	Hollow shaft $p_m = \frac{\Delta d}{d} \frac{1}{\left[\frac{m_s - 1}{m_s E_s} - \frac{m_i - 1}{m_i E_i} \right] + 2 \left[\frac{k_0^2}{E_s (1 - k_0^2)} + \frac{1}{E_i (1 - k^2)} \right]}$ Solid shaft $p_m = \frac{\Delta d}{d} \frac{1}{\left[\frac{m_s - 1}{m_s E_s} - \frac{m_i - 1}{m_i E_i} \right] + \frac{2}{E_i (1 - k^2)}}$	Housing outside diameter $p_m = \frac{\Delta D}{D} \frac{1}{\left[\frac{m_e - 1}{m_e E_e} - \frac{m_h - 1}{m_h E_h} \right] + 2 \left[\frac{k^2}{E_e (1 - k^2)} + \frac{1}{E_h (1 - h_0^2)} \right]}$
Expansion of Inner Ring Raceway ΔD_i (mm) Contraction of Outer Ring Raceway ΔD_e (mm)	$\Delta D_i = 2d \frac{p_m}{E_i} \frac{k}{1 - k^2}$ $= \Delta d \cdot k \frac{1 - k_0^2}{1 - k^2 k_0^2} \text{ (hollow shaft)}$ $= \Delta d \cdot k \text{ (solid shaft)}$	$\Delta D_e = 2D \frac{p_m}{E_e} \frac{h}{1 - h^2}$ $= \Delta D \cdot h \frac{1 - h_0^2}{1 - h^2 h_0^2}$
Maximum Stress $\sigma_{t \max}$ (MPa) {kgf/mm ² }	Maximum circumferential stress at inner ring bore fitting surface. $\sigma_{t \max} = p_m \frac{1 + k^2}{1 - k^2}$	Maximum circumferential stress at outer ring outer surface. $\sigma_{t \max} = p_m \frac{2}{1 - h^2}$
Symbols	d : Shaft diameter, inner ring bore d_0 : Hollow shaft bore D_i : Inner ring raceway diameter $k = d/D_i$, $k_0 = d_0/d$ E_i : Inner ring Young's modulus, 208 000 MPa {21 200 kgf/mm ² } E_s : Shaft Young's modulus m_i : Inner ring Poisson's number, 3.33 m_s : Shaft Poisson's number	D : Housing bore diameter, outer ring outside diameter D_0 : Housing outside diameter D_e : Outer ring raceway diameter $h = D_e/D$, $h_0 = D_0/D_0$ E_e : Outer ring Young's modulus, 208 000 MPa {21 200 kgf/mm ² } E_h : Housing Young's modulus m_e : Outer ring Poisson's number, 3.33 m_h : Housing Poisson's number

(6) Surface Pressure and Maximum Stress on Fitting Surfaces

In order for rolling bearings to achieve their full life expectancy, their fitting must be appropriate. Usually an interference fit is chosen for a rotating inner ring, and a loose fit is used for a fixed outer ring. To select the fit, the magnitude of the load, the temperature differences among the bearing and shaft and housing, material characteristics of the shaft and housing, level of finish, material thickness, and bearing mounting/dismounting method must all be considered.

If the interference is insufficient for the operating conditions, ring loosening, creep, fretting, heat generation, or other problems may occur. If the interference is excessive, the ring may crack due to circumferential stress. The magnitude of the interference is usually satisfactory if it follows recommendations for the size of the shaft or housing listed in the bearing catalog. To determine surface pressure and stress on the fitting surfaces, calculations can be made assuming a thick-walled cylinder with uniform internal and external pressures; necessary equations for this are summarized in Table 8.2. For convenience in fitting bearing inner rings on solid steel shafts, which are the most common type of shaft, the surface pressure and maximum stress are shown in Figs. 8.3 and 8.4.

Fig. 8.3 shows the surface pressure p_m and maximum stress $\sigma_{t\ max}$ for given combinations of bearing bores for mean interference at various tolerance grades. Fig. 8.4 shows the maximum surface pressure p_m and maximum stress $\sigma_{t\ max}$ when maximum interference occurs.

Fig. 8.4 is convenient for checking if $\sigma_{t\ max}$ exceeds acceptable limits. The tensile strength of hardened bearing steel is about 1 570 to 1 960 MPa {160 to 200 kgf/mm²}. However, for safety, plan for a maximum fitting stress of 127 MPa {13 kgf/mm²}. For reference, the distributions of circumferential stress σ_t and radial stress σ_r in an inner ring are shown in Fig. 8.2.

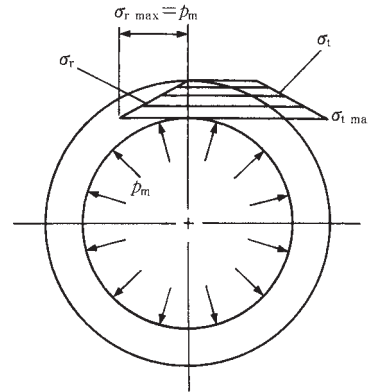

Fig. 8.2 Distribution of Circumferential Stress σ_t and Radial Stress σ_r

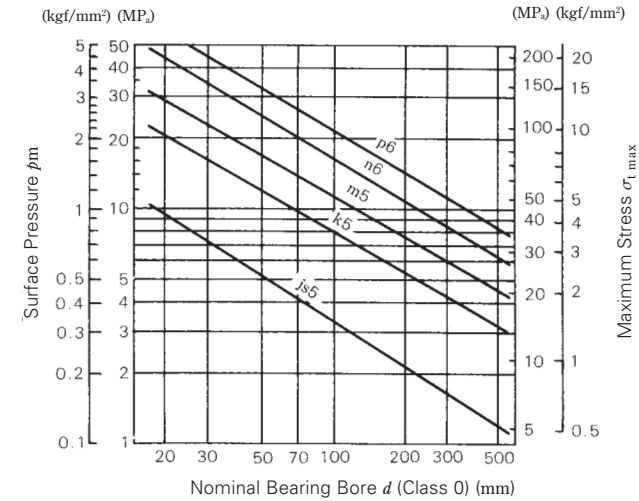

Fig. 8.3 Surface Pressure p_m and Maximum Stress $\sigma_{t\ max}$ for Mean Interference in Various Tolerance Grades

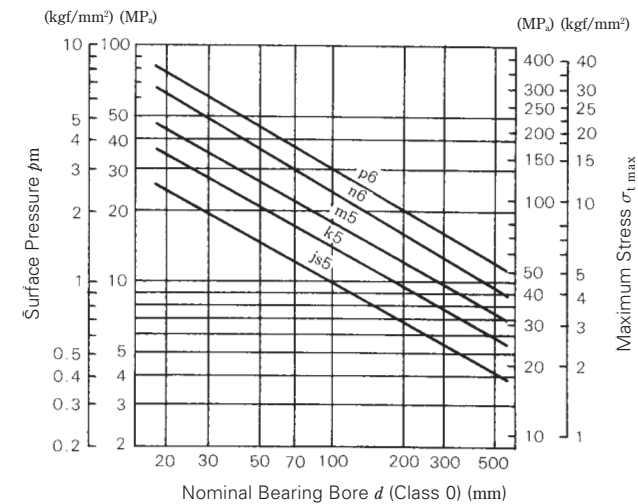

Fig. 8.4 Surface Pressure p_m and Maximum Stress $\sigma_{t\ max}$ for Maximum Interference in Various Tolerance Grades

(7) Press-Fit Force and Withdrawal Force

The force needed to mount bearings on shafts or in a housing hole with interference can be obtained using the thick-walled cylinder theory.

The press-fit force (or withdrawal force) depends upon the contact area, surface pressure, and coefficient of friction between the fitting surfaces.

The press-fit force (or withdrawal force) K needed to mount inner rings on shafts is given by Equation (8.6).

$$K = \mu p_m \pi d B \text{ (N), [kgf]} \dots\dots\dots (8.6)$$

where μ : Coefficient of friction between fitting surfaces

$\mu=0.12$ (for press-fitting)

$\mu=0.18$ (for withdrawal)

p_m : Surface pressure (MPa), [kgf/mm²]

For example, inner ring surface pressure can be obtained using Table 8.2.

$$p_m = \frac{E}{2} \frac{\Delta d}{d} \frac{(1-k^2)(1-k_0^2)}{1-k^2 k_0^2}$$

d : Shaft diameter (mm)

B : Bearing width (mm)

Δd : Effective interference (mm)

E : Young's modulus of steel (MPa), [kgf/mm²]
 $E=208\,000$ MPa {21 200 kgf/mm²}

k : Inner ring thickness ratio

$$k = d/D_i$$

D_i : Inner ring raceway diameter (mm)

k_0 : Hollow shaft thickness ratio

$$k_0 = d_0/d$$

d_0 : Bore diameter of hollow shaft (mm)

For solid shafts, $d_0=0$, consequently $k_0=0$. The value of k varies depending on bearing type and size, but it usually ranges between $k=0.7$ and 0.9 . Assuming that $k=0.8$ and the shaft is solid, Equation (8.6) becomes the following:

$$\left. \begin{aligned} K &= 118\,000\mu \Delta d B \text{ (N)} \\ &= 12\,000\mu \Delta d B \text{ [kgf]} \end{aligned} \right\} \dots\dots\dots (8.7)$$

Equation (8.7) is shown graphically in Fig. 8.5. The press-fit and withdrawal forces for outer rings and housings have also been calculated and the results are shown in Fig. 8.6.

The actual press-fit and withdrawal forces can become much higher than the calculated values if the bearing ring and shaft (or housing) are slightly misaligned or load is applied unevenly to the circumference of the bearing ring. Consequently, the values obtained from Figs. 8.5 and 8.6 should be considered only as guides when designing withdrawal tools. Tool strength should be five to six times higher than that indicated by the figures.

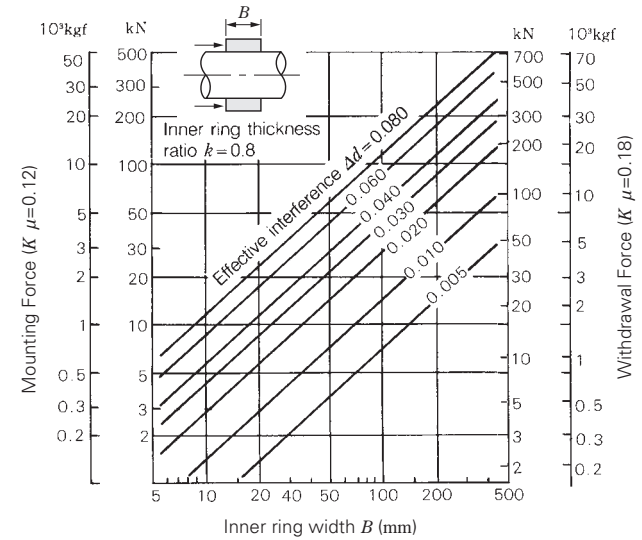

Fig. 8.5 Press-Fit and Withdrawal Forces for Inner Rings

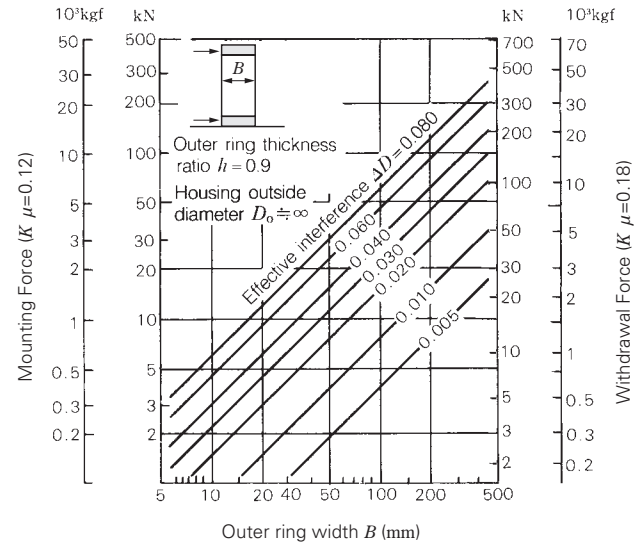

Fig. 8.6 Press-Fit and Withdrawal Forces for Outer Rings

8.1.3 Recommended Fits

As described previously, many factors, such as the characteristics and magnitude of bearing load, temperature differences, and means of bearing mounting and dismounting, must be considered when selecting the proper fit.

If the housing is thin or the bearing is mounted on a hollow shaft, a tighter than usual fit is necessary. A split housing often deforms the bearing into an oval shape; therefore, a split housing should be avoided when a tight fit with the outer ring is required.

The fits of both the inner and outer rings should be tight in applications where the shaft is subjected to considerable vibration.

The recommended fits for some common applications are shown in Tables 8.3 to 8.8. Please consult NSK regarding unusual operating conditions. For the tolerances and surface finish of shafts and housings, please refer to Section 13.1 (Page A270).

Table 8.3 Fits of Radial Bearings (Normal Class, Class 6X, and Class 6) With Shafts

Load Conditions	Examples	Shaft Diameter (mm)			Tolerance of Shaft	Remarks	
		Ball Brgs	Cylindrical Roller Brgs, Tapered Roller Brgs	Spherical Roller Brgs			
Radial Bearings With Cylindrical Bores							
Rotating Outer Ring Load	Easy axial displacement of inner ring on shaft is necessary.	Wheels on Stationary Axles	All Shaft Diameters			g6	Use g5 and h5 where accuracy is required. f6 can be used in large bearings to allow easy axial movement.
	Easy axial displacement of inner ring on shaft is unnecessary	Tension Pulleys Rope Sheaves				h6	
Rotating Inner Ring Load or Indeterminate Direction of Load	Light Loads or Variable Loads (<0.06C _r (¹))	Electrical Home Appliances Pumps, Blowers, Transport Vehicles, Precision Machinery, Machine Tools	<18	—	—	js5	Use Class 5 and high-precision bearings where accuracy is required. Use h5 for high-precision ball bearings with bore diameters of 18 mm or less. k6 and m6 can be used for single-row tapered roller bearings and single-row angular contact ball bearings instead of k5 and m5. A bearing internal clearance greater than CN is necessary.
			18 to 100	<40	—	js6(j6)	
			100 to 200	40 to 140	—	k6	
	Normal Loads (0.06 to 0.13C _r (¹))	General Bearing Applications, Medium and Large Motors(³), Turbines, Pumps, Engine Main Bearings, Gears, Woodworking Machines	<18	—	—	js5 or js6 (j5 or j6)	
			18 to 100	<40	<40	k5 or k6	
			100 to 140	40 to 100	40 to 65	m5 or m6	
			140 to 200	100 to 140	65 to 100	m6	
			200 to 280	140 to 200	100 to 140	n6	
			—	200 to 400	140 to 280	p6	
			—	—	280 to 500	r6	
—	—	over 500	r7				
Heavy Loads or Shock Loads (>0.13C _r (¹))	Railway Axleboxes, Industrial Vehicles, Traction Motors, Construction Equipment, Crushers	—	50 to 140	50 to 100	n6		
		—	140 to 200	100 to 140	p6		
		—	over 200	140 to 200	r6		
Axial Loads Only	All Types of Bearing Applications	All Shaft Diameters			js6 (j6)	—	
		Radial Bearings With Tapered Bores and Sleeves					
All Types of Loading	General Bearing Applications, Railway Axleboxes Transmission Shafts, Woodworking Spindles	All Shaft Diameters			h9/IT5(²)	The deviation of the shaft from its true geometric form, e. g. roundness and cylindricity should be within the tolerances of IT5 and IT7.	
					h10/IT7(²)		

Notes (¹) C_r represents the basic load rating of the bearing.
 (²) Refer to Appendix Table 11 on Page E016 for the values of IT standard tolerance grades.
 (³) Refer to Tables 8.14.1 and 8.14.2 for the recommended fits of shafts used in electric motors for deep groove ball bearings with bore diameters ranging from 10 mm to 160 mm and for cylindrical roller bearings with bore diameters ranging from 24 mm to 200 mm.
Remark This table applies only to solid steel shafts.

Table 8.4 Fits of Thrust Bearings With Shafts

Load Conditions	Examples	Shaft Diameter (mm)	Tolerance of Shaft	Remarks	
Central Axial Load Only	Main Shafts of Lathes	All Shaft Diameters	h6 or js6 (j6)	—	
Combined Radial and Axial Loads (Spherical Thrust Roller Bearings)	Stationary Inner Ring Load	Cone Crushers	js6 (j6)		
	Rotating Inner Ring Load or Indeterminate Direction of Load	Paper Pulp Refiners, Plastic Extruders	<200		k6
		200 to 400	m6		
over 400	n6				

Table 8.5 Fits of Radial Bearings (Normal Class, Class 6X, and Class 6) With Housings

Load Conditions		Examples	Tolerances for Housing Bores	Axial Displacement of Outer Ring	Remarks
Solid Housings	Rotating Outer Ring Load	Heavy Loads on Bearing in Thin-Walled Housing or Heavy Shock Loads	P7	Impossible	—
		Normal or Heavy Loads	N7		
	Light or Variable Loads	M7			
Solid or Split Housings	Indeterminate Direction of Load	Heavy Shock Loads	K7	Generally Impossible	If axial displacement of the outer ring is not required.
		Normal or Heavy Loads			
	Rotating Inner Ring Load	Normal or Light Loads	JS7 (J7)	Possible	Axial displacement of outer ring is necessary.
		Any Kind of Load	H7	Easily possible	—
Normal or Light Loads	H8				
Solid Housing	Rotating Inner Ring Load	High Temperature Rise of Inner Ring Through Shaft	G7	Possible	—
		Accurate Running Required Under Normal or Light Loads	JS6 (J6)		
	Indeterminate Direction of Load	Grinding Spindle Rear Ball Bearings, High Speed Centrifugal Compressor Free Bearings	K6	Generally Impossible	For heavy loads, an interference fit tighter than K may be used. When high accuracy is required, very strict tolerances should be used for fitting.
		Grinding Spindle Front Ball Bearings, High Speed Centrifugal Compressor Fixed Bearings			
Rotating Inner Ring Load	Accurate Running and High Rigidity Required Under Variable Loads	M6 or N6	Impossible	Easily Possible	—
	Minimal noise is required.	H6			

Note (¹) Refer to Tables 8.14.1 and 8.14.2 for the recommended fits of housing bores of deep groove ball bearings and cylindrical roller bearings for electric motors.
Remarks
 1. This table is applicable to cast-iron and steel housings. For housings made of light alloys, the interference should be tighter than listed in this table.
 2. Refer to the introductory section of the bearing tables for special fits, such as those for drawn cup needle roller bearings.

Table 8.6 Fits of Thrust Bearings With Housings

Load Conditions	Bearing Types	Tolerances for Housing Bores	Remarks
Axial Loads Only	Thrust Ball Bearings	Clearance over 0.25mm H8	For General Applications When precision is required
	Spherical Thrust Roller Bearings, Steep Angle Tapered Roller Bearings	Outer ring has radial clearance.	When radial loads are sustained by other bearings
Combined Radial and Axial Loads	Stationary Outer Ring Loads	Spherical Thrust Roller Bearings	H7 or JS7 (J7)
			K7
	Rotating Outer Ring Loads or Indeterminate Direction of Load	M7	Relatively Heavy Radial Loads

Table 8.7 Fits of Inch Series Tapered Roller Bearings With Shafts

(1) Bearings of Precision Classes 4 and 2 Units : μm

Operating Conditions		Nominal Bore Diameters d				Bore Diameter Tolerances Δ_{ds}		Shaft Diameter Tolerances		Remarks
		over		incl.		high low		high low		
		(mm)	1/25.4	(mm)	1/25.4					
Rotating Inner Ring Loads	Normal Loads	—	—	76.200	3.0000	+13	0	+38	+25	For bearings with $d \leq 152.4$ mm, clearance is usually larger than CN. In general, bearings with a clearance larger than CN are used. ※ indicates that the average interference is about 0.0005 d .
		304.800	12.0000	304.800	12.0000	+25	0	+64	+38	
		609.600	24.0000	609.600	24.0000	+51	0	+127	+76	
	Heavy Loads Shock Loads High Speeds	—	—	76.200	3.0000	+13	0	+64	+38	
		304.800	12.0000	304.800	12.0000	+25	0	※	※	
		609.600	24.0000	609.600	24.0000	+51	0	※	※	
Rotating Outer Ring Loads	Normal Loads Without Shocks	—	—	76.200	3.0000	+13	0	+13	0	The inner ring cannot be displaced axially. When heavy or shock loads exist, the figures above (rotating inner ring loads, heavy or shock loads) apply.
		304.800	12.0000	304.800	12.0000	+25	0	+25	0	
		609.600	24.0000	609.600	24.0000	+51	0	+51	0	
	The inner ring can be displaced axially.	—	—	76.200	3.0000	+13	0	0	-13	
		304.800	12.0000	304.800	12.0000	+25	0	0	-25	
		609.600	24.0000	609.600	24.0000	+51	0	0	-51	
The inner ring can be displaced axially.	—	—	76.200	3.0000	+13	0	0	-76		
	304.800	12.0000	304.800	12.0000	+25	0	0	-25		
	609.600	24.0000	609.600	24.0000	+51	0	0	-76		

(2) Bearings of Precision Classes 3 and 0 (1) Units : μm

Operating Conditions		Nominal Bore Diameters d				Bore Diameter Tolerances Δ_{ds}		Shaft Diameter Tolerances		Remarks
		over		incl.		high low		high low		
		(mm)	1/25.4	(mm)	1/25.4					
Rotating Inner Ring Loads	Precision Machine-Tool Main Spindles	—	—	76.200	3.0000	+13	0	+30	+18	—
		304.800	12.0000	304.800	12.0000	+13	0	+30	+18	
		609.600	24.0000	609.600	24.0000	+25	0	+64	+38	
	Heavy Loads Shock Loads High Speeds	—	—	76.200	3.0000	+13	0	—	—	
		304.800	12.0000	304.800	12.0000	+13	0	—	—	
		609.600	24.0000	609.600	24.0000	+25	0	—	—	
Rotating Outer Ring Loads	Precision Machine-Tool Main Spindles	—	—	76.200	3.0000	+13	0	+30	+18	—
		304.800	12.0000	304.800	12.0000	+13	0	+30	+18	
		609.600	24.0000	609.600	24.0000	+25	0	+64	+38	
	The outer ring can be displaced axially.	—	—	76.200	3.0000	+13	0	+30	+18	
		304.800	12.0000	304.800	12.0000	+13	0	+30	+18	
		609.600	24.0000	609.600	24.0000	+25	0	+64	+38	

Note (1) For bearings with d greater than 304.8 mm, Class 0 does not exist.

Table 8.8 Fits of Inch Series Tapered Roller Bearings With Housings

(1) Bearings of Precision Classes 4 and 2 Units : μm

Operating Conditions		Nominal Outside Diameters D				Outside Diameter Tolerances Δ_{Ds}		Housing Bore Diameter Tolerances		Remarks
		over		incl.		high low		high low		
		(mm)	1/25.4	(mm)	1/25.4					
Rotating Inner Ring Loads	Used either on free-end or fixed-end	—	—	76.200	3.0000	+25	0	+76	+51	The outer ring can be easily displaced axially.
		304.800	12.0000	304.800	12.0000	+25	0	+76	+51	
		609.600	24.0000	609.600	24.0000	+51	0	+152	+102	
	The outer ring position can be adjusted axially.	—	—	76.200	3.0000	+25	0	+25	0	
		304.800	12.0000	304.800	12.0000	+25	0	+25	0	
		609.600	24.0000	609.600	24.0000	+51	0	+76	+25	
Rotating Outer Ring Loads	Normal Loads The outer ring position cannot be adjusted axially.	—	—	76.200	3.0000	+25	0	-13	-38	Generally, the outer ring is fixed axially.
		304.800	12.0000	304.800	12.0000	+25	0	-25	-51	
		609.600	24.0000	609.600	24.0000	+51	0	-25	-76	
	The outer ring position cannot be adjusted axially.	—	—	76.200	3.0000	+25	0	-13	-38	
		304.800	12.0000	304.800	12.0000	+25	0	-25	-51	
		609.600	24.0000	609.600	24.0000	+51	0	-25	-76	

(2) Bearings of Precision Classes 3 and 0 (1) Units : μm

Operating Conditions		Nominal Outside Diameters D				Outside Diameter Tolerances Δ_{Ds}		Housing Bore Diameter Tolerances		Remarks
		over		incl.		high low		high low		
		(mm)	1/25.4	(mm)	1/25.4					
Rotating Inner Ring Loads	Used on free-end	—	—	152.400	6.0000	+13	0	+38	+25	The outer ring can be easily displaced axially.
		304.800	12.0000	304.800	12.0000	+13	0	+38	+25	
		609.600	24.0000	609.600	24.0000	+25	0	+64	+38	
	Used on fixed-end	—	—	152.400	6.0000	+13	0	+25	+13	
		304.800	12.0000	304.800	12.0000	+13	0	+25	+13	
		609.600	24.0000	609.600	24.0000	+25	0	+51	+25	
Rotating Outer Ring Loads	The outer ring position can be adjusted axially.	—	—	152.400	6.0000	+13	0	+13	0	Generally, the outer ring is fixed axially.
		304.800	12.0000	304.800	12.0000	+13	0	+25	0	
		609.600	24.0000	609.600	24.0000	+25	0	+38	0	
	The outer ring position cannot be adjusted axially.	—	—	152.400	6.0000	+13	0	0	-13	
		304.800	12.0000	304.800	12.0000	+13	0	0	-25	
		609.600	24.0000	609.600	24.0000	+25	0	0	-25	
Rotating Outer Ring Loads	Normal Loads The outer ring position cannot be adjusted axially.	—	—	76.200	3.0000	+13	0	-13	-25	The outer ring is fixed axially.
		304.800	12.0000	304.800	12.0000	+13	0	-13	-38	
		609.600	24.0000	609.600	24.0000	+25	0	-13	-38	
	The outer ring position cannot be adjusted axially.	—	—	76.200	3.0000	+13	0	-13	-25	
		304.800	12.0000	304.800	12.0000	+13	0	-13	-38	
		609.600	24.0000	609.600	24.0000	+25	0	-13	-38	

Note (1) For bearings with D greater than 304.8 mm, Class 0 does not exist.

8.2 Bearing Internal Clearances

8.2.1 Internal Clearances and Their Standards

The internal clearance of rolling bearings in operation greatly influences bearing performance including fatigue life, vibration, noise, heat generation, etc. Consequently, the selection of proper internal clearance is one of the most important tasks when choosing a bearing after the type and size have been determined.

This bearing internal clearance refers to the combined clearances between the inner/outer rings and rolling elements. The radial and axial internal clearances are defined as the total amount that one ring can be displaced relative to the other in the radial and axial directions respectively (Fig. 8.7).

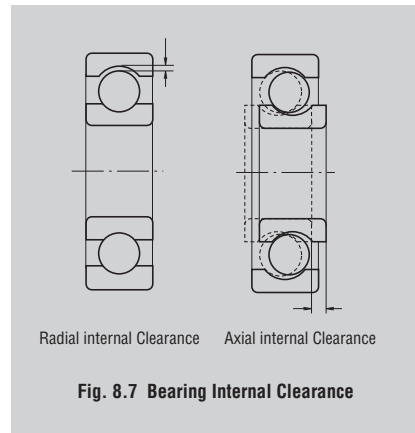

Fig. 8.7 Bearing Internal Clearance

To obtain accurate measurements, the clearance is generally measured by applying a specified measuring load on the bearing. This “measured clearance” is always slightly larger than the theoretical internal clearance (“geometrical clearance” for radial bearings) by the amount of elastic deformation caused by the measuring load.

Therefore, the theoretical internal clearance may be obtained by correcting the measured clearance by the amount of elastic deformation. However, in the case of roller bearings, this elastic deformation is negligibly small.

Usually the clearance before mounting is specified by the theoretical internal clearance.

In Table 8.9, reference table and page numbers are listed by bearing types.

Table 8.9 Index for Radial Internal Clearances by Bearing Type

Bearing Type		Table Number	Page Number
Deep Groove Ball Bearings		8.10	A169
Extra Small and Miniature Ball Bearings		8.11	A169
Magneto Bearings		8.12	A169
Self-Aligning Ball Bearings		8.13	A170
Deep Groove Ball Bearings	For Motors	8.14.1	A170
Cylindrical Roller Bearings		8.14.2	A170
Cylindrical Roller Bearings	With Cylindrical Bores	8.15	A171
	With Cylindrical Bores (Matched)		
	With Tapered Bores (Matched)		
Spherical Roller Bearings	With Cylindrical Bores	8.16	A172
	With Tapered Bores		
Double-Row and Combined Tapered Roller Bearings		8.17	A173
Combined Angular Contact Ball Bearings ⁽¹⁾		8.18	A174
Four-Point-Contact Ball Bearings ⁽¹⁾		8.19	A174

Note ⁽¹⁾ Values given are axial internal clearances.

Table 8.10 Radial Internal Clearances in Deep Groove Ball Bearings

Units : m

Nominal Bore Diameter <i>d</i> (mm)	Clearance										
	C2		CN		C3		C4		C5		
over	incl.	min.	max.	min.	max.	min.	max.	min.	max.	min.	max.
10 only		0	7	2	13	8	23	14	29	20	37
10	18	0	9	3	18	11	25	18	33	25	45
18	24	0	10	5	20	13	28	20	36	28	48
24	30	1	11	5	20	13	28	23	41	30	53
30	40	1	11	6	20	15	33	28	46	40	64
40	50	1	11	6	23	18	36	30	51	45	73
50	65	1	15	8	28	23	43	38	61	55	90
65	80	1	15	10	30	25	51	46	71	65	105
80	100	1	18	12	36	30	58	53	84	75	120
100	120	2	20	15	41	36	66	61	97	90	140
120	140	2	23	18	48	41	81	71	114	105	160
140	160	2	23	18	53	46	91	81	130	120	180
160	180	2	25	20	61	53	102	91	147	135	200
180	200	2	30	25	71	63	117	107	163	150	230
200	225	2	35	25	85	75	140	125	195	175	265
225	250	2	40	30	95	85	160	145	225	205	300
250	280	2	45	35	105	90	170	155	245	225	340
280	315	2	55	40	115	100	190	175	270	245	370
315	355	3	60	45	125	110	210	195	300	275	410
355	400	3	70	55	145	130	240	225	340	315	460
400	450	3	80	60	170	150	270	250	380	350	510
450	500	3	90	70	190	170	300	280	420	390	570
500	560	10	100	80	210	190	330	310	470	440	630
560	630	10	110	90	230	210	360	340	520	490	690
630	710	20	130	110	260	240	400	380	570	540	760
710	800	20	140	120	290	270	450	430	630	600	840

Remarks To obtain the measured values, use the clearance correction values in the table below. For the C2 clearance class, the smaller value should be used for bearings with minimum clearance and the larger value for bearings near the maximum clearance range.

Units : m

Nominal Bore Dia. <i>d</i> (mm)	Measuring Load (N) {kgf}	Radial Clearance Correction Amount						
		C2	CN	C3	C4	C5		
10 (incl)	18	24.5	{2.5}	3 to 4	4	4	4	4
18	50	49	{5}	4 to 5	5	6	6	6
50	280	147	{15}	6 to 8	8	9	9	9

Remark For values exceeding 280 mm, please contact NSK.

Table 8.11 Radial Internal Clearances in Extra Small and Miniature Ball Bearings

Units : m

Clearance Symbol	MC1	MC2	MC3	MC4	MC5	MC6
	min. max.	min. max.	min. max.	min. max.	min. max.	min. max.
Clearance	0 5	3 8	5 10	8 13	13 20	20 28

Remarks 1. The standard clearance is MC3.
2. To obtain the measured value, add correction amount from the table below.

Units : m

Clearance Symbol	MC1	MC2	MC3	MC4	MC5	MC6
Clearance Correction Value	1	1	1	1	2	2

The measuring loads are as follows:
For miniature ball bearings*
2.5N {0.25kgf}
For extra small ball bearings*
4.4N {0.45kgf}

*For classification details, refer to Table 1 on Page C054.

Table 8.12 Radial Internal Clearances in Magneto Bearings

Units : m

Nominal Bore Diameter <i>d</i> (mm)	Bearing Series	Clearance	
		min.	max.
2.5	30	EN	10 50
		E	30 60

Table 8.13 Radial Internal Clearances in Self-Aligning Ball Bearings

Units : μm

Nominal Bore Dia. <i>d</i> (mm)		Clearance in Bearings With Cylindrical Bores					Clearance in Bearings With Tapered Bores								
over	incl.	C2		CN		C3		C4		C5					
		min.	max.	min.	max.	min.	max.	min.	max.	min.	max.				
2.5	6	1	8	5	15	10	20	15	25	21	33	—	—	—	—
6	10	2	9	6	17	12	25	19	33	27	42	—	—	—	—
10	14	2	10	6	19	13	26	21	35	30	48	—	—	—	—
14	18	3	12	8	21	15	28	23	37	32	50	—	—	—	—
18	24	4	14	10	23	17	30	25	39	34	52	7	17	13	26
24	30	5	16	11	24	19	35	29	46	40	58	9	20	15	28
30	40	6	18	13	29	23	40	34	53	46	66	12	24	19	35
40	50	6	19	14	31	25	44	37	57	50	71	14	27	22	39
50	65	7	21	16	36	30	50	45	69	62	88	18	32	27	47
65	80	8	24	18	40	35	60	54	83	76	108	23	39	35	57
80	100	9	27	22	48	42	70	64	96	89	124	29	47	42	68
100	120	10	31	25	56	50	83	75	114	105	145	35	56	50	81
120	140	10	38	30	68	60	100	90	135	125	175	40	68	60	98
140	160	15	44	35	80	70	120	110	161	150	210	45	74	65	110

Table 8.14 Radial Internal Clearances in Bearings for Electric Motors

Table 8.14.1 Deep Groove Ball Bearings for Electric Motors

Units : μm

Nominal Bore Dia. <i>d</i> (mm)		Clearance		Remarks	
over	incl.	CM		Recommended fit	
		min.	max.	Shaft	Housing Bore
10 (incl)	18	4	11	js5 (j5)	H6, H7 ⁽¹⁾ or JS6, JS7 (J6, J7) ⁽²⁾
18	30	5	12	k5	
30	50	9	17		
50	80	12	22		
80	100	18	30		
100	120	18	30	m5	
120	160	24	38		

Notes ⁽¹⁾ Applicable to outer rings that require movement in the axial direction.

⁽²⁾ Applicable to outer rings that do not require movement in the axial direction.

Remark The radial internal clearance increase caused by the measuring load is equal to the correction amount for CN clearance listed in the remarks under Table 8.10.

Table 8.14.2 Cylindrical Roller Bearings for Electric Motors

Units : μm

Nominal Bore Dia. <i>d</i> (mm)		Clearance				Remarks	
over	incl.	Interchangeable CT		Non-Interchangeable CM		Recommended Fit	
		min.	max.	min.	max.	Shaft	Housing Bore
24	40	15	35	15	30	k5	JS6, JS7 (J6, J7) ⁽¹⁾ or K6, K7 ⁽²⁾
40	50	20	40	20	35	m5	
50	65	25	45	25	40		
65	80	30	50	30	45		
80	100	35	60	35	55		
100	120	35	65	35	60		
120	140	40	70	40	65	n6	
140	160	50	85	50	80		
160	180	60	95	60	90		
180	200	65	105	65	100		

Notes ⁽¹⁾ Applicable to outer rings that require movement in the axial direction.

⁽²⁾ Applicable to outer rings that do not require movement in the axial direction.

Table 8.15 Radial Internal Clearances in Cylindrical Roller Bearings and Solid Needle Roller Bearings

Units : μm

Nominal Bore Dia. <i>d</i> (mm)		Clearances in Bearings With Cylindrical Bores					Clearances in Noninterchangeable Bearings With Cylindrical Bores																
over	incl.	C2		CN		C3		C4		C5		CC1		CC2		CC ⁽¹⁾		CC3		CC4		CC5	
		min.	max.	min.	max.	min.	max.	min.	max.	min.	max.	min.	max.	min.	max.	min.	max.	min.	max.	min.	max.	min.	max.
10	24	0	25	20	45	35	60	50	75	65	90	5	15	10	20	20	30	35	45	45	55	65	75
24	30	0	25	20	45	35	60	50	75	70	95	5	15	10	25	25	35	40	50	50	60	70	80
30	40	5	30	25	50	45	70	60	85	80	105	5	15	12	25	25	40	45	55	55	70	80	95
40	50	5	35	30	60	50	80	70	100	95	125	5	18	15	30	30	45	50	65	65	80	95	110
50	65	10	40	40	70	60	90	80	110	110	140	5	20	15	35	35	50	55	75	75	90	110	130
65	80	10	45	40	75	65	100	90	125	130	165	10	25	20	40	40	60	70	90	90	110	130	150
80	100	15	50	50	85	75	110	105	140	155	190	10	30	25	45	45	70	80	105	105	125	155	180
100	120	15	55	50	90	85	125	125	165	180	220	10	30	25	50	50	80	95	120	120	145	180	205
120	140	15	60	60	105	100	145	145	190	200	245	10	35	30	60	60	90	105	135	135	160	200	230
140	160	20	70	70	120	115	165	165	215	225	275	10	35	35	65	65	100	115	150	150	180	225	260
160	180	25	75	75	125	120	170	170	220	250	300	10	40	35	75	75	110	125	165	165	200	250	285
180	200	35	90	90	145	140	195	195	250	275	330	15	45	40	80	80	120	140	180	180	220	275	315
200	225	45	105	105	165	160	220	220	280	305	365	15	50	45	90	90	135	155	200	200	240	305	350
225	250	45	110	110	175	170	235	235	300	330	395	15	50	50	100	100	150	170	215	215	265	330	380
250	280	55	125	125	195	190	260	260	330	370	440	20	55	55	110	110	165	185	240	240	295	370	420
280	315	55	130	130	205	200	275	275	350	410	485	20	60	60	120	120	180	205	265	265	325	410	470
315	355	65	145	145	225	225	305	305	385	455	535	20	65	65	135	135	200	225	295	295	360	455	520
355	400	100	190	190	280	280	370	370	460	510	600	25	75	75	150	150	225	255	330	330	405	510	585
400	450	110	210	210	310	310	410	410	510	565	665	25	85	85	170	170	255	285	370	370	455	565	650
450	500	110	220	220	330	330	440	440	550	625	735	25	95	95	190	190	285	315	410	410	505	625	720

Note ⁽¹⁾ CC denotes normal clearance for noninterchangeable cylindrical roller bearings and solid needle roller bearings.

Units : μm

Nominal Bore Dia. <i>d</i> (mm)		Clearances in Noninterchangeable Bearings with Tapered Bores															
over	incl.	CC9 ⁽¹⁾		CC0		CC1		CC2		CC ⁽²⁾		CC3		CC4		CC5	
		min.	max.	min.	max.	min.	max.	min.	max.	min.	max.	min.	max.	min.	max.	min.	max.
10	24	5	10	—	—	10	20	20	30	35	45	45	55	55	65	75	85
24	30	5	10	8	15	10	25	25	35	40	50	50	60	60	70	80	95
30	40	5	12	8	15	12	25	25	40	45	55	55	70	70	80	95	110
40	50	5	15	10	20	15	30	30	45	50	65	65	80	80	95	110	125
50	65	5	15	10	20	15	35	35	50	55	75	75	90	90	110	130	150
65	80	10	20	15	30	20	40	40	60	70	90	90	110	110	130	150	170
80	100	10	25	20	35	25	45	45	70	80	105	105	125	125	150	180	205
100	120	10	25	20	35	25	50	50	80	95	120	120	145	145	170	205	230
120	140	15	30	25	40	30	60	60	90	105	135	135	160	160	190	230	260
140	160	15	35	30	50	35	65	65	100	115	150	150	180	180	215	260	295
160	180	15	35	30	50	35	75	75	110	125	165	165	200	200	240	285	320
180	200	20	40	30	50	40	80	80	120	140	180	180	220	220	260	315	355
200	225	20	45	35	60	45	90	90	135	155	200	200	240	240	285	350	395
225	250	25	50	40	65	50	100	100	150	170	215	215	265	265	315	380	430
250	280	25	55	40	70	55	110	110	165	185	240	240	295	295	350	420	475
280	315	30	60	—	—	60	120	120	180	205	265	265	325	325	385	470	530
315	355	30	65	—	—	65	135	135	200	225	295	295	360	360	430	520	585
355	400	35	75	—	—	75	150	150	225	255	330	330	405	405	480	585	66

Table 8.16 Radial Internal Clearances in Spherical Roller Bearings

Units : μm

Nominal Bore Dia. <i>d</i> (mm)		Clearance in Bearings With Cylindrical Bores					Clearance in Bearings With Tapered Bores								
		C2		CN	C3		C4		C5						
over	incl.	min.	max.	min.	max.	min.	max.	min.	max.	min.	max.	min.	max.	min.	max.
24	30	15	25	25	40	40	55	55	75	75	95	20	30	30	40
30	40	15	30	30	45	45	60	60	80	80	100	25	35	35	50
40	50	20	35	35	55	55	75	75	100	100	125	30	45	45	60
50	65	20	40	40	65	65	90	90	120	120	150	40	55	55	75
65	80	30	50	50	80	80	110	110	145	145	180	50	70	70	95
80	100	35	60	60	100	100	135	135	180	180	225	55	80	80	110
100	120	40	75	75	120	120	160	160	210	210	260	65	100	100	135
120	140	50	95	95	145	145	190	190	240	240	300	80	120	120	160
140	160	60	110	110	170	170	220	220	280	280	350	90	130	130	180
160	180	65	120	120	180	180	240	240	310	310	390	100	140	140	200
180	200	70	130	130	200	200	260	260	340	340	430	110	160	160	220
200	225	80	140	140	220	220	290	290	380	380	470	120	180	180	250
225	250	90	150	150	240	240	320	320	420	420	520	140	200	200	270
250	280	100	170	170	260	260	350	350	460	460	570	150	220	220	300
280	315	110	190	190	280	280	370	370	500	500	630	170	240	240	330
315	355	120	200	200	310	310	410	410	550	550	690	190	270	270	360
355	400	130	220	220	340	340	450	450	600	600	750	210	300	300	400
400	450	140	240	240	370	370	500	500	660	660	820	230	330	330	440
450	500	140	260	260	410	410	550	550	720	720	900	260	370	370	490
500	560	150	280	280	440	440	600	600	780	780	1 000	290	410	410	540
560	630	170	310	310	480	480	650	650	850	850	1 100	320	460	460	600
630	710	190	350	350	530	530	700	700	920	920	1 190	350	510	510	670
710	800	210	390	390	580	580	770	770	1 010	1 010	1 300	390	570	570	750
800	900	230	430	430	650	650	860	860	1 120	1 120	1 440	440	640	640	840
900	1 000	260	480	480	710	710	930	930	1 220	1 220	1 570	490	710	710	930
1 000	1 120	290	530	530	780	780	1 020	1 020	1 330	—	—	530	770	770	1 030
1 120	1 250	320	580	580	860	860	1 120	1 120	1 460	—	—	570	830	830	1 120
1 250	1 400	350	640	640	950	950	1 240	1 240	1 620	—	—	620	910	910	1 230

Table 8.17 Radial Internal Clearances in Double-Row and Combined Tapered Roller Bearings

Units : μm

Nominal Bore Dia. <i>d</i> (mm)		Clearance													
		C1		C2		CN		C3		C4		C5			
over	incl.	min.	max.	min.	max.	min.	max.	min.	max.	min.	max.	min.	max.	min.	max.
—	18	0	10	10	20	20	30	35	45	50	60	65	75	—	—
18	24	0	10	10	20	20	30	35	45	50	60	65	75	—	—
24	30	0	10	10	20	20	30	40	50	50	60	70	80	—	—
30	40	0	12	12	25	25	40	45	60	60	75	80	95	—	—
40	50	0	15	15	30	30	45	50	65	65	80	95	110	—	—
50	65	0	15	15	35	35	55	60	80	80	100	110	130	—	—
65	80	0	20	20	40	40	60	70	90	90	110	130	150	—	—
80	100	0	25	25	50	50	75	80	105	105	130	155	180	—	—
100	120	5	30	30	55	55	80	90	115	120	145	180	210	—	—
120	140	5	35	35	65	65	95	100	130	135	165	200	230	—	—
140	160	10	40	40	70	70	100	110	140	150	180	220	260	—	—
160	180	10	45	45	80	80	115	125	160	165	200	250	290	—	—
180	200	10	50	50	90	90	130	140	180	180	220	280	320	—	—
200	225	20	60	60	100	100	140	150	190	200	240	300	340	—	—
225	250	20	65	65	110	110	155	165	210	220	270	330	380	—	—
250	280	20	70	70	120	120	170	180	230	240	290	370	420	—	—
280	315	30	80	80	130	130	180	190	240	260	310	410	460	—	—
315	355	30	80	80	130	140	190	210	260	290	350	450	510	—	—
355	400	40	90	90	140	150	200	220	280	330	390	510	570	—	—
400	450	45	95	95	145	170	220	250	310	370	430	560	620	—	—
450	500	50	100	100	150	190	240	280	340	410	470	620	680	—	—
500	560	60	110	110	160	210	260	310	380	450	520	700	770	—	—
560	630	70	120	120	170	230	290	350	420	500	570	780	850	—	—
630	710	80	130	130	180	260	310	390	470	560	640	870	950	—	—
710	800	90	140	150	200	290	340	430	510	630	710	980	1 060	—	—
800	900	100	150	160	210	320	370	480	570	700	790	1 100	1 200	—	—
900	1 000	120	170	180	230	360	410	540	630	780	870	1 200	1 300	—	—
1 000	1 120	130	190	200	260	400	460	600	700	—	—	—	—	—	—
1 120	1 250	150	210	220	280	450	510	670	770	—	—	—	—	—	—
1 250	1 400	170	240	250	320	500	570	750	870	—	—	—	—	—	—

Remark Axial internal clearance $\Delta_a = \Delta_r \cot \alpha \div \frac{1.5}{e} \Delta_r$
 where Δ_r : Radial internal clearance
 α : Contact angle
 e : Constant (listed in bearing tables)

Table 8.18 Axial Internal Clearances in Combined Angular Contact Ball Bearings (Measured Clearance)

Units : μm

Nominal Bore Diameter, d (mm)		Axial Internal Clearance											
		Contact Angle 30°						Contact Angle 40°					
		CN		C3		C4		CN		C3		C4	
over	incl.	min.	max.	min.	max.	min.	max.	min.	max.	min.	max.	min.	max.
—	10	9	29	29	49	49	69	6	26	26	46	46	66
10	18	10	30	30	50	50	70	7	27	27	47	47	67
18	24	19	39	39	59	59	79	13	33	33	53	53	73
24	30	20	40	40	60	60	80	14	34	34	54	54	74
30	40	26	46	46	66	66	86	19	39	39	59	59	79
40	50	29	49	49	69	69	89	21	41	41	61	61	81
50	65	35	60	60	85	85	110	25	50	50	75	75	100
65	80	38	63	63	88	88	115	27	52	52	77	77	100
80	100	49	74	74	99	99	125	35	60	60	85	85	110
100	120	72	97	97	120	120	145	52	77	77	100	100	125
120	140	85	115	115	145	145	175	63	93	93	125	125	155
140	160	90	120	120	150	150	180	66	96	96	125	125	155
160	180	95	125	125	155	155	185	68	98	98	130	130	160
180	200	110	140	140	170	170	200	80	110	110	140	140	170

Remark This table is applicable to bearings with Normal and Class 6 tolerances. Please consult NSK regarding the internal axial clearances of bearings with Class 5 tolerance or better and contact angles of 15° and 25°.

Table 8.19 Axial Internal Clearance in Four-Point-Contact Ball Bearings (Measured Clearances)

Units : μm

Nominal Bore Dia. d (mm)		Axial Internal Clearance					
		CN		C3		C4	
over	incl.	min.	max.	min.	max.	min.	max.
10	18	45	85	75	125	115	165
18	40	56	106	96	146	136	186
40	60	76	126	116	166	156	206
60	80	86	136	126	176	166	226
80	100	96	156	136	196	186	246
100	140	116	176	156	216	206	266
140	180	136	196	176	246	226	296
180	220	156	226	206	276	256	326
220	260	175	245	225	305	285	365
260	300	195	275	255	335	315	395
300	350	215	305	275	365	345	425
350	400	245	335	315	405	385	475
400	500	285	385	355	455	435	525

8.2.2 Selection of Bearing Internal Clearances

CN Clearance is adequate for standard operating conditions. Clearance becomes progressively smaller from C2 to C1 and larger from C3 to C5.

Standard operating conditions are defined as those where the inner ring speed is less than approximately 50 % of the limiting speed listed in the bearing tables, the load is less than normal ($P \leq 0.1C_r$), and the bearing has a tight fit on the shaft.

To reduce bearing noise, the radial internal clearance range is narrower than the normal class and the values are somewhat smaller for deep groove ball bearings and cylindrical roller bearings for electric motors (refer to Table 8.14.1 and 8.14.2).

Internal clearance varies with the fit and temperature differences in operation. The changes in radial internal clearance in a roller bearing are shown in Fig. 8.8.

(1) Decrease in Radial Clearance Caused by Fitting and Residual Clearance

When the inner ring or the outer ring has a tight fit on a shaft or in a housing, a decrease in the radial internal clearance is caused by the expansion or contraction of the bearing rings. The decrease varies according to the bearing type, bearing size, and design of the shaft and housing. The amount of this decrease is approximately 70 to 90% of the interference (refer to Section 8.1.2, Selection of Fit, (5) Fitting Stress and Ring Expansion and Contraction, Pages A156 and A157). The internal clearance after subtracting this decrease from the theoretical internal clearance Δ_0 is called the residual clearance Δ_f .

(2) Decrease in Radial Internal Clearance Caused by Temperature Differences Between Inner and Outer Rings and Effective Clearance

The frictional heat generated during operation is conducted away from the bearing through the shaft and housing. Since housings generally conduct heat better than shafts, the temperature of the inner ring and the rolling elements is usually higher than that of the outer ring by 5 to 10 °C. If the shaft is heated or the housing is cooled, the difference in temperature between the inner and outer rings increases. The radial clearance decreases due to the thermal expansion caused by the temperature difference between the inner and outer rings. The amount of this decrease can be calculated using the following equations:

$$\delta_t \doteq \alpha \Delta_t D_e \dots \dots \dots (8.8)$$

where δ_t : Decrease in radial clearance due to temperature difference between inner and outer rings (mm)

α : Coefficient of linear expansion of bearing steel $\doteq 12.5 \times 10^{-6}$ (1/°C)

Δ_t : Temperature difference between inner and outer rings (°C)

D_e : Outer ring raceway diameter (mm)

For ball bearings

$$D_e \doteq \frac{1}{5} (4D+d) \dots \dots \dots (8.9)$$

For roller bearings

$$D_e \doteq \frac{1}{4} (3D+d) \dots \dots \dots (8.10)$$

The clearance after subtracting δ_t from the residual clearance Δ_f is called the effective clearance Δ . Theoretically, the longest life of a bearing can be achieved when the effective clearance is slightly negative. However, it is difficult to achieve such an ideal condition, and an excessive negative clearance will greatly shorten the bearing life. Therefore, a clearance of zero or a slightly positive amount, instead of a negative one, should be selected. When single-row angular contact ball bearings or tapered roller bearings are used facing each other, there should be a small effective clearance, unless a preload is required. When two cylindrical roller bearings with a rib on one side are used facing each other, adequate axial clearance is necessary to allow for shaft elongation during operation.

The radial clearances used in some specific applications are given in Table 8.20. Please consult NSK regarding special operating conditions.

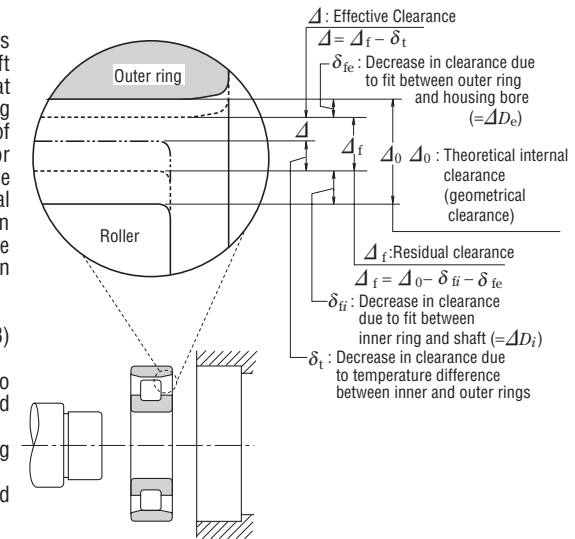

Fig. 8.8 Changes in Radial Internal Clearance of Bearings

Table 8.20 Example Clearances for Specific Applications

Operating Conditions	Examples	Internal Clearance
When shaft deflection is large	Semi-floating rear wheels of automobiles	C5 or equivalent
When steam passes through hollow shafts or roller shafts are heated	Dryers in paper making machines	C3, C4
	Table rollers for rolling mills	C3
When impact loads and vibration are severe or when both the inner and outer rings are tight-fitted	Traction motors for railways	C4
	Vibrating screens	C3, C4
	Fluid couplings	C4
When both the inner and outer rings are loose-fitted	Final reduction gears for tractors	C4
	Rolling mill roll necks	C2 or equivalent
When noise and vibration restrictions are severe	Small motors with special specifications	C1, C2, CM
When clearance is adjusted after mounting to prevent shaft deflection, etc.	Main shafts of lathes	CC9, CC1

8.3 Technical Data

8.3.1 Temperature Rise and Dimensional Change

Rolling bearings are extremely precise mechanical elements; any change in dimensional accuracy due to temperature cannot be ignored. Accordingly, as a rule, measurement of a bearing must be performed at 20 °C and the dimensions set forth in the standards must be expressed by values at 20 °C.

Dimensional changes due to temperature change not only affect dimensional accuracy, but also cause changes in the internal clearance of a bearing during operation. Dimensional change may cause interference between the inner ring and shaft or between the outer ring and housing bore. It is possible to achieve shrink fitting with large interference by utilizing dimensional changes induced by temperature differences. The dimensional change Δl due to temperature rise can be expressed as Equation (8.11) below:

$$\Delta l = \Delta T \alpha l \text{ (mm)} \dots\dots\dots (8.11)$$

- where, Δl : Dimensional change (mm)
- ΔT : Temperature rise (°C)
- α : Coefficient of linear expansion for bearing steel
 $\alpha = 12.5 \times 10^{-6} \text{ (1/°C)}$
- l : Original dimension (mm)

Equation (8.11) may be illustrated as shown in Fig. 8.9. In the following cases, Fig. 8.9 can be utilized to easily obtain an approximate numerical values for dimensional change when there is, need to:

- (1) Correct dimensional measurements according to the ambient air temperature
- (2) Find the change in bearing internal clearance due to a temperature difference between the inner and outer rings during operation
- (3) Find the relationship between interference and heating temperature during shrink fitting
- (4) Find the change in interference when a temperature difference exists on the fit surface

Example

If an inner ring with a 110 mm bore is to be shrink-fitted to an n6 tolerance shaft, how much should it be heated?

The maximum interference between an inner ring with a 110 mm bore and an n6 shaft is 0.065 mm. To enable insertion of the inner ring with ease on the shaft, there must be a clearance of 0.03 to 0.04 mm. Accordingly, the inner ring must expand by 0.095 to 0.105 mm.

By using Fig 8.9, the intersection of the vertical axis when $\Delta l = 0.105$ and the horizontal axis when $l = 110$ can be determined. ΔT is located in the temperature range between 70 °C and 80 °C ($\Delta T \approx 77^\circ\text{C}$). Therefore, it's sufficient to set the inner ring heating temperature to the room temperature +80 °C.

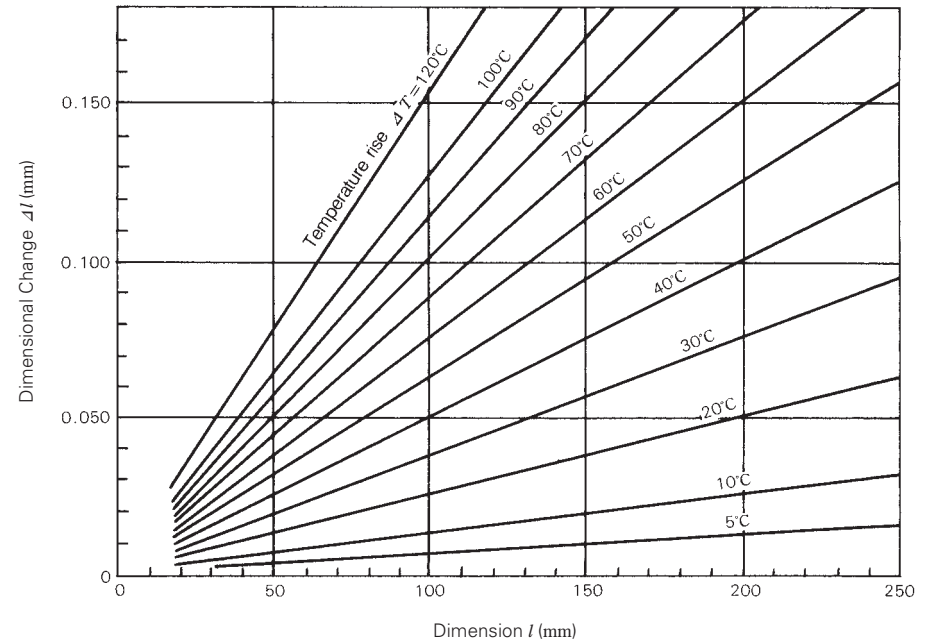

Fig. 8.9 Temperature Rise and Dimensional Change of Bearing Steel

8.3.2 Interference Deviation Due to Temperature Rise (Aluminum Housing, Plastic Housing)

Bearing housing materials such as aluminum, light alloys, or plastics (polyacetal resin, etc.) are often used to reduce weight and cost or improve the performance of equipment.

When non-ferrous materials are used in housings, any temperature rise occurring during operation affects the interference or clearance of the outer ring due to the difference in the coefficients of linear expansion. This change is significant for plastics which have high coefficients of linear expansion.

The deviation of clearance or interference of a fitting surface ΔD_T of a bearing's outer ring due to temperature rise is expressed by the following equation:

$$\Delta D_T = (\alpha_1 \cdot \Delta T_1 - \alpha_2 \cdot \Delta T_2) D \quad \text{.....(8.12)}$$

- where ΔD_T : Change of clearance or interference at fitting surface due to temperature rise
- α_1 : Coefficient of linear expansion of housing (1/°C)
- ΔT_1 : Housing temperature rise near fitting surface (°C)
- α_2 : Coefficient of linear expansion of bearing outer ring
Bearing steel $\alpha_2 = 12.5 \times 10^{-6}$ (1/°C)
- ΔT_2 : Outer ring temperature rise near fitting surface (°C)
- D : Nominal outside diameter (mm)

In general, housing temperature rise and outer ring temperature rise are somewhat different, but if we assume they are approximately equal near the fitting surfaces ($\Delta T_1 \doteq \Delta T_2 = \Delta T$), Equation (8.12) becomes Equation (8.13):

$$\Delta D_T = (\alpha_1 - \alpha_2) \Delta T \cdot D \quad \text{.....(8.13)}$$

where ΔT : Temperature rise of outer ring and housing near fitting surfaces (°C)

Equation (8.13) for aluminum housings ($\alpha_1 = 23.7 \times 10^{-6}$), can be shown graphically as Fig. 8.10. Polyacetal resin is the plastic most-often used for bearing housings. The coefficients of linear expansion of plastics may vary or show directional characteristics. For molded products made with polyacetal resin, the coefficient of linear expansion is approximately 9×10^{-5} . Equation (8.13) for polyacetal-resin housings can be expressed as Fig. 8.11.

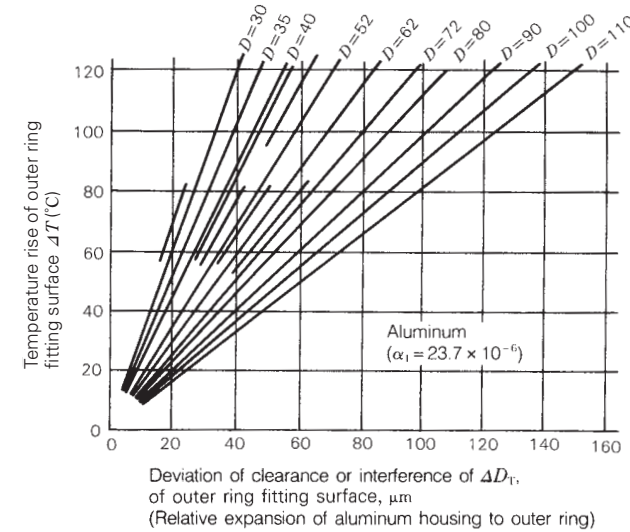

Fig. 8.10 Aluminum Housing

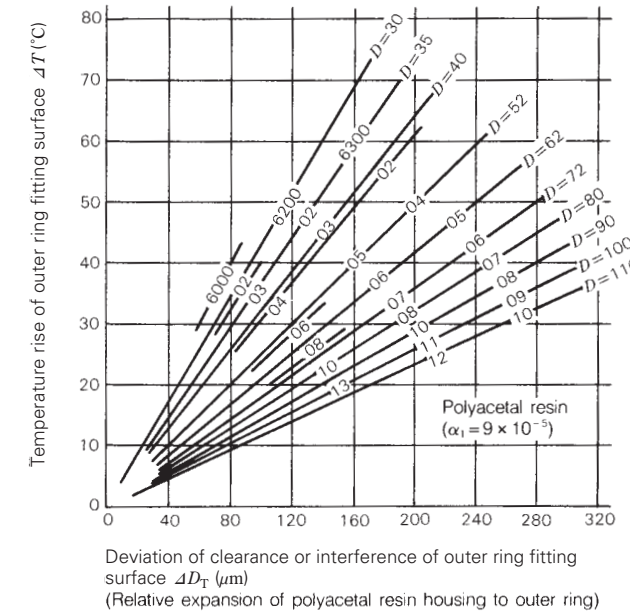

Fig. 8.11 Polyacetal-Resin Housing

8.3.3 Calculating Residual Internal Clearance After Mounting

The various types of internal bearing clearance were discussed in Section 8.2.2. This section will explain the step by step procedures for calculating residual internal clearance.

When the inner ring of a bearing is press-fit onto a shaft or when the outer ring is press fit into a housing, it stands to reason that radial internal clearance will decrease due to the resulting expansion or contraction of the bearing raceways. Generally, most bearing applications have a rotating shaft which requires a tight fit between the inner ring and shaft and a loose fit between the outer ring and housing; therefore, generally only the effect of the interference on the inner ring needs to be taken into account.

Below we have selected a 6310 single row deep groove ball bearing for our representative calculations. The shaft is set as k5 and the housing set as H7. An interference fit is applied only to the inner ring. Shaft diameter, bore size, and radial clearance are standard bearing measurements. Assuming that 99.7% of the parts are within tolerance, the mean value of residual clearance $m_{\Delta f}$ and standard deviation of the internal clearance after mounting (residual clearance) $\sigma_{\Delta f}$ can be calculated. Measurements are given in millimeters (mm).

$$\sigma_s = \frac{R_s/2}{3} = 0.0018$$

$$\sigma_i = \frac{R_i/2}{3} = 0.0020$$

$$\sigma_{\Delta 0} = \frac{R_{\Delta 0}/2}{3} = 0.0028$$

$$\sigma_f^2 = \sigma_s^2 + \sigma_i^2$$

$$m_{\Delta f} = m_{\Delta 0} - \lambda_i (m_s - m_i) = 0.0035$$

$$\sigma_{\Delta f} = \sqrt{\sigma_{\Delta 0}^2 + \lambda_i^2 \sigma_f^2} = 0.0035$$

- where, σ_s : Standard deviation of shaft diameter
- σ_i : Standard deviation of bore diameter
- σ_f : Standard deviation of interference
- $\sigma_{\Delta 0}$: Standard deviation of radial clearance (before mounting)
- $\sigma_{\Delta f}$: Standard deviation of residual clearance (after mounting)
- m_s : Mean value of shaft diameter ($\phi 50 + 0.008$)
- m_i : Mean value of bore diameter ($\phi 50 - 0.006$)
- $m_{\Delta 0}$: Mean value of radial clearance (before mounting) (0.014)
- $m_{\Delta f}$: Mean value of residual clearance (after mounting)
- R_s : Shaft tolerance (0.011)
- R_i : Bearing bore tolerance (0.012)
- $R_{\Delta 0}$: Range in radial clearance (before mounting) (0.017)
- λ_i : Rate of raceway expansion from apparent interference (0.75 from Fig. 8.12)

The average amount of raceway expansion and contraction from apparent interference is calculated from $\lambda_i (m_m - m_i)$.

To determine, within a 99.7% probability, the variation in internal clearance after mounting $R_{\Delta f}$, use the following equation:

$$R_{\Delta f} = m_{\Delta f} \pm 3\sigma_{\Delta f} = +0.014 \text{ to } -0.007$$

In other words, the mean value of residual clearance ($m_{\Delta f}$) is +0.0035, and the range is from -0.007 to +0.014 for bearing 6310.

Units : mm	
Shaft diameter	$\phi 50 \begin{matrix} +0.013 \\ +0.002 \end{matrix}$
Bearing bore diameter, (d)	$\phi 50 \begin{matrix} 0 \\ -0.012 \end{matrix}$
Radial internal clearance (Δ_0)	0.006 to 0.023 ⁽¹⁾

Note ⁽¹⁾ Standard internal clearance, unmounted

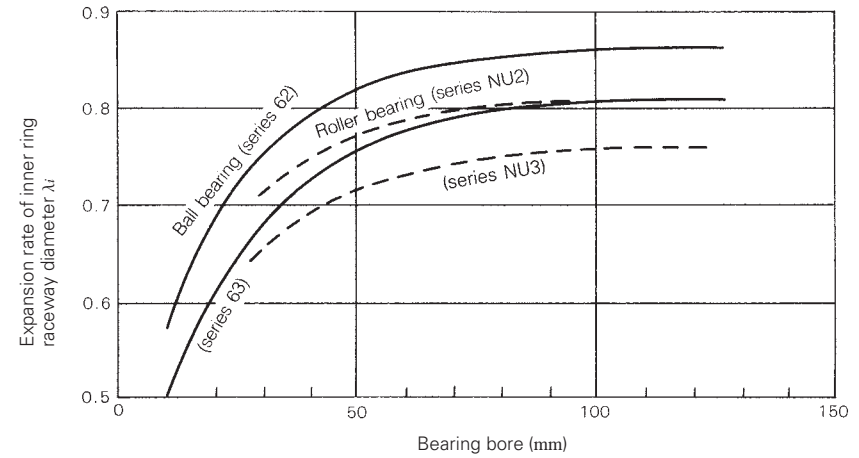

Fig. 8.12 λ_i : Rate of Inner Ring Raceway Expansion From Apparent Interference

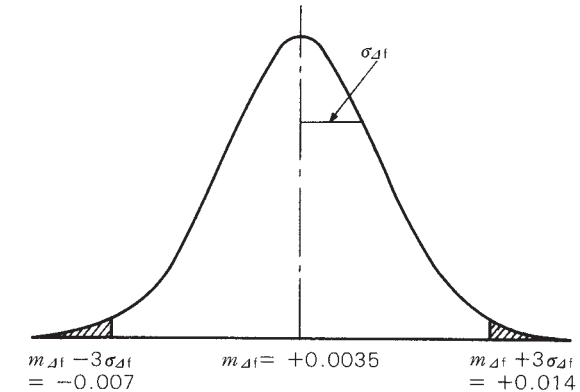

Fig. 8.13 Distribution of Residual Internal Clearance

8.3.4 Effect of Interference Fits on Bearing Raceways (Fit of Inner Ring)

One important factor related to radial clearance is the reduction in radial clearance resulting from the mounting fit. When an inner ring is mounted on a shaft with an interference fit and the outer ring is secured in a housing with an interference fit, the inner ring will expand and the outer ring will contract. The means of calculating the amount of ring expansion or contraction were previously noted in Section 8.1.2 (5); however, the equation for establishing the amount of inner raceway expansion ΔD_i is given in Equation (8.14) below:

$$\Delta D_i = \Delta d k \frac{1 - k_0^2}{1 - k^2 k_0^2} \dots \dots \dots (8.14)$$

- where, Δd : Effective interference (mm)
- k : Ratio of bore to inner raceway diameter;
 $k = d/D_i$
- k_0 : Ratio of inside to outside diameter of hollow shaft; $k_0 = d_0/D_i$
- d : Bore or shaft diameter (mm)
- D_i : Inner raceway diameter (mm)
- d_0 : Inside diameter of hollow shaft (mm)

Equation (8.14) is represented in a clearer graphical form in Fig. 8.14.

The vertical axis of Fig. 8.14 represents inner raceway diameter expansion in relation to the amount of interference. The horizontal axis represents k_0 ; the ratio of the inside diameter of a hollow shaft to the outside diameter.

Generally, the decrease in radial clearance is calculated to be approximately 80% of the interference for solid shaft mountings only. For hollow shaft mountings the decrease in radial clearance varies with the ratio of inside shaft diameter to outside shaft diameter. Since the general 80% rule is based on average bearing bore size to inner raceway diameter ratios, the change will vary with different bearing types, sizes, and series. Typical plots for single-row deep groove ball bearings and for cylindrical roller bearings are shown in Figs. 8.15 and 8.16. Values in Fig. 8.14 apply only for steel shafts.

As an example, let us determine the decrease in the radial clearance of a 6220 ball bearing mounted on a hollow shaft (diameter $d=100$ mm, inside diameter $d_0=65$ mm) with a fit class of m5.

The ratio between bore diameter and raceway diameter k is 0.87 as shown in Fig. 8.15. The ratio of the shaft inside diameter to the shaft outside diameter k_0 , is $k_0 = d_0/d = 0.65$. Thus, reading from Fig. 8.14, the rate of raceway expansion is 73%.

Given that an interference of m5 has a mean value of 30 μm , the amount of raceway expansion, or, the

amount of decrease in the radial clearance from the fit is $0.73 \times 30 = 22 \mu\text{m}$.

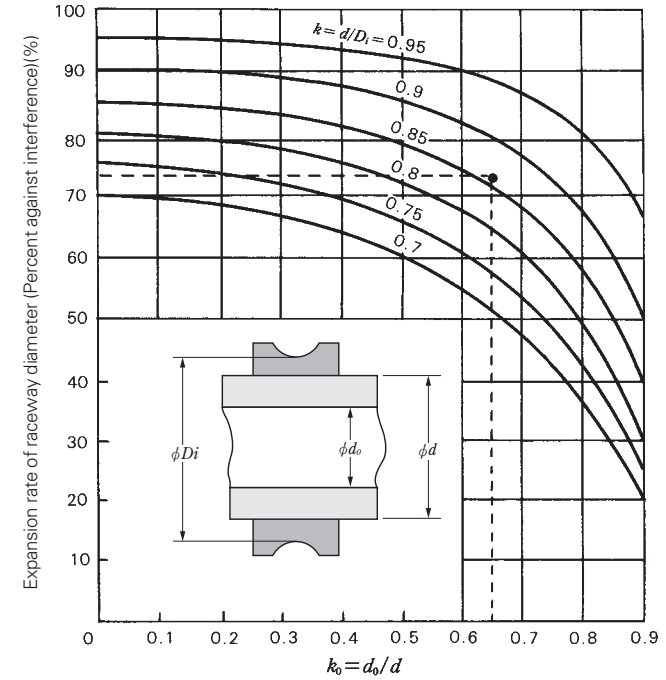

Fig. 8.14 Raceway Expansion in Relation to Bearing Fit (Inner Ring Fit on Steel Shaft)

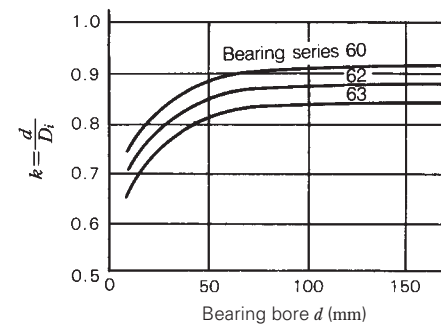

Fig. 8.15 Ratio of Bore Size to Raceway Diameter for Single-Row Deep Groove Ball Bearings

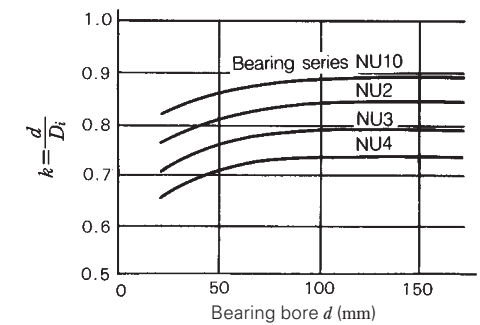

Fig. 8.16 Ratio of Bore Size to Raceway Diameter for Cylindrical Roller Bearings

8.3.5 Effect of Interference Fits on Bearing Raceways (Fit of Outer Ring)

When a bearing load is applied on a rotating inner ring (outer ring carrying a static load), an interference fit is adopted for the inner ring and the outer ring is mounted either with a transition fit or a clearance fit. However, when load is applied on a rotating outer ring (inner ring carrying a static load) or when there is an indeterminate load and the outer ring must be mounted with an interference fit, a decrease in radial internal clearance caused by the fit begins to contribute in the same way as when the inner ring is mounted with an interference fit. Because the amount of interference that can be applied to the outer ring is limited by stress, the constraints of most bearing applications make it difficult to apply a large amount of interference to the outer ring. In addition, instances where there is an indeterminate load are quite rare compared to those where a rotating inner ring carries the load; therefore, there are few occasions where it is necessary to be cautious about the decrease in radial clearance caused by outer ring interference. The decrease in outer raceway diameter ΔD_e is calculated using Equation (8.15) below:

$$\Delta D_e = \Delta D \cdot h \frac{1 - h_0^2}{1 - h^2 h_0^2} \dots \dots \dots (8.15)$$

- where ΔD : Effective interference (mm)
- h : Ratio between raceway dia. and outside dia. of outer ring, $h = D_e/D$
- h_0 : Housing thickness ratio, $h_0 = D/D_0$
- D : Bearing outside diameter (housing bore diameter) (mm)
- D_e : Raceway diameter of outer ring (mm)
- D_0 : Outside diameter of housing (mm)

Fig. 8.17 represents the above equation graphically. The vertical axis shows the outer ring raceway contraction as a percentage of interference, and the horizontal axis shows the housing thickness ratio h_0 . The data are plotted for constant values of outer ring thickness ratios from 0.7 through 1.0 in increments of 0.05. The value of thickness ratio h will differ with bearing type, size, and diameter series. Representative values for single-row deep groove ball bearings and cylindrical roller bearings are given in Figs. 8.18 and 8.19 respectively.

Loads applied on rotating outer rings occur in such applications as automotive front axles, tension pulleys, conveyor systems, and other pulley systems. As an example, let us estimate the decrease in radial clearance for a 6207 ball bearing mounted in a steel housing with an N7 fit. The outside diameter of the housing is assumed as $D_0 = 95$, and the bearing outside diameter $D = 72$. From Fig. 8.18, the outer ring thickness ratio, h , is 0.9. Because $h_0 = D/D_0 = 0.76$, the raceway contraction is 71 %, as indicated in Fig 8.17. Taking the mean value for N7 interference as 18 μm , the contraction of the outer raceway, or decrease in radial clearance is $0.71 \times 18 \approx 13 \mu\text{m}$.

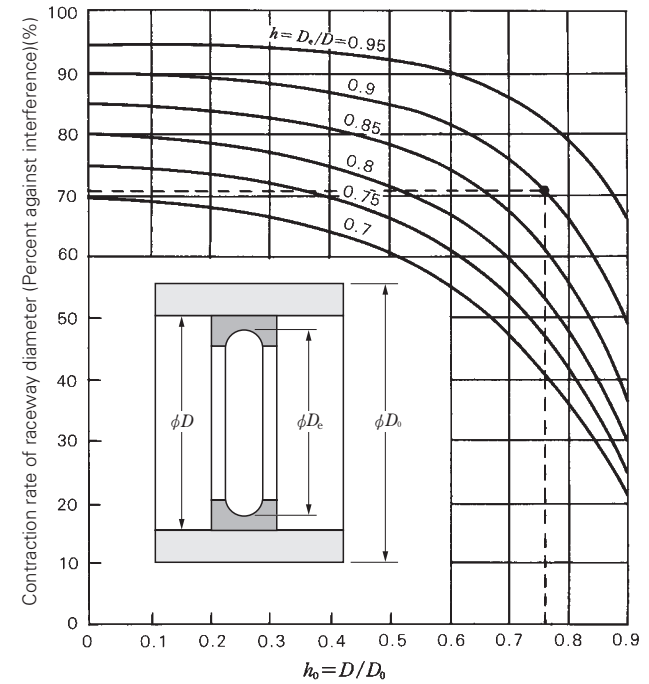

Fig. 8.17 Raceway Contraction in Relation to Bearing Fit (Outer Ring Fit in Steel Housing)

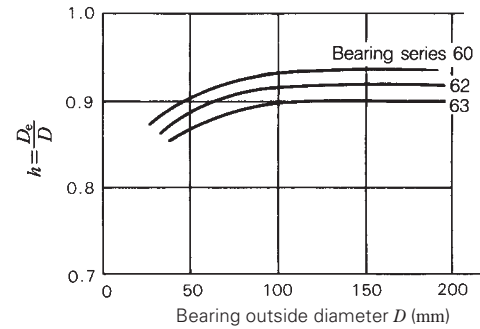

Fig. 8.18 Ratio of Outside Diameter to Raceway Diameter for Single-Row Deep Groove Ball Bearings

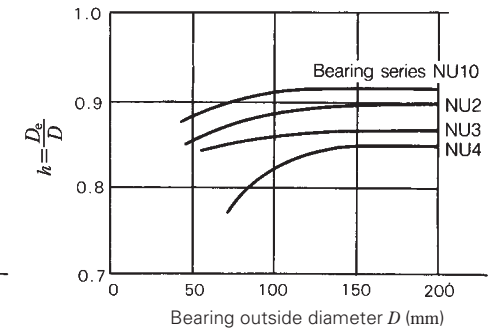

Fig. 8.19 Ratio of Outside Diameter to Raceway Diameter for Cylindrical Roller Bearings

FITS AND INTERNAL CLEARANCES

8.3.6 Measuring Internal Clearance of Combined Tapered Roller Bearings (Offset Measuring Method)

Combined tapered roller bearings are available in two types: a back-to-back arrangement (DB type) and a face-to-face arrangement (DF type) (see Figs. 8.20 and Fig. 8.21). These arrangements have certain advantages and can be assembled as a set or combined with other bearings as a fixed- or free-side bearing.

The cages of DB tapered roller bearing arrangements protrude from the back side of the outer ring; therefore, the outer ring spacer (K spacer in Fig. 8.20) is mounted to prevent mutual contact of cages. An inner ring spacer (L spacer in Fig. 8.20), with the appropriate width is provided for the inner ring to secure the clearance. For the DF type, a K spacer is used, as shown in Fig. 8.21.

In general, to use such a bearing arrangement requires an appropriate clearance that accounts for heat generated during operation or an applied preload that increases the rigidity of the bearings. The spacer width should be adjusted so as to provide an appropriate clearance or preload (minus clearance) after mounting. The clearance measurement method for a DB arrangement is as follows:

- (1) As shown in Fig. 8.22, put bearing A on the surface plate and after stabilizing the rollers by rotating the outer ring (over 10 turns), measure the offset $f_A = T_A - B_A$ (consult Figs. 8.22 through 8.24 for these symbols).
- (2) Next, as shown in Fig. 8.23, use the same procedure to measure bearing B for its offset $f_B = T_B - B_B$.
- (3) Last, measure the width of the K and L spacers as shown in Fig. 8.24.

From the results of the above measurements, the axial clearance Δ_a of the arrangement can be obtained by Equation (8.16):

$$\Delta_a = (L - K) - (f_A + f_B) \dots\dots\dots (8.16)$$

As an example, let's confirm the clearance of tapered roller bearing arrangement HR32232JDB + KLR10AC3 to specifications. First, refer to Table 8.17 and note that the C3 clearance range is $\Delta_r = 110$ to $140 \mu\text{m}$.

To compare this specification with the offset measurement results, convert it into axial clearance Δ_a by using Equation (8.17):

$$\Delta_a = \Delta_r \cot \alpha \approx \Delta_r \frac{1.5}{e} \dots\dots\dots (8.17)$$

where e : Constant determined for each bearing No. (listed in the bearing tables of this catalog)

By referring to Page C205, we find $e = 0.44$ and the following:

$$\begin{aligned} \Delta_a &= (110 \text{ to } 140) \times \frac{1.5}{e} \\ &\approx 380 \text{ to } 480 \mu\text{m} \end{aligned}$$

We can confirm that the bearing clearance is C3 by verifying that the axial clearance Δ_a of Equation (8.16) (obtained by the bearing offset measurement) is within the above-mentioned range.

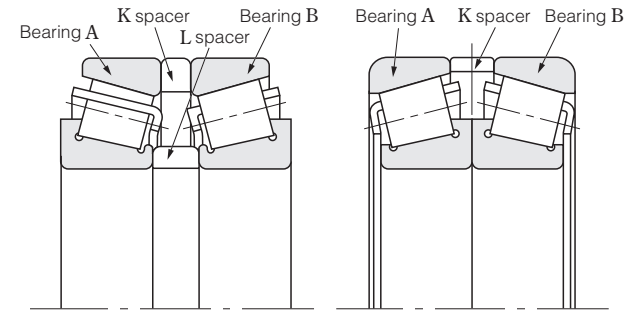

Fig. 8.20 DB Arrangement

Fig. 8.21 DF Arrangement

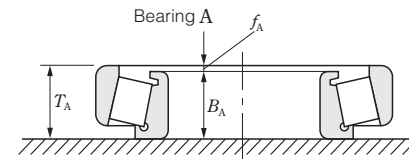

Fig. 8.22

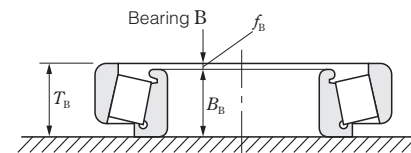

Fig. 8.23

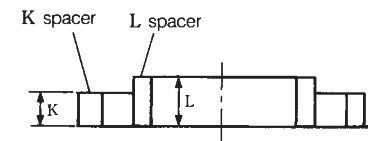

Fig. 8.24

8.3.7 Internal Clearance Adjustment When Mounting a Tapered Roller Bearing

Two single-row tapered roller bearings are usually arranged in a configuration opposite each other with clearance adjusted in the axial direction. There are two types of opposite placement methods: back-to-back (DB arrangement) and face-to-face (DF arrangement). Clearance adjustment for a back-to-back arrangement is performed by tightening the inner ring by a shaft nut or a shaft end bolt. In Fig. 8.25, an example using a shaft-end bolt is shown. In this case, the fit on the tightened side of the inner ring with the shaft must be loose to allow displacement of the inner ring in the axial direction.

For a face-to-face arrangement (Fig. 8.26), a shim is inserted between the cover, which retains the outer ring in the axial direction, and the housing in order to allow adjustment to the specified axial clearance. In this case, use a loose fit between the tightened side of the outer ring and the housing in order to allow appropriate displacement of the outer ring in the axial direction. This is not necessary when the surrounding structure is designed to install the outer ring into a retaining cover (Fig. 8.27), allowing for both easy mounting and dismounting.

Theoretically, fatigue life is longest when bearing clearance is slightly negative during operation; however if the negative clearance is excessive, fatigue life becomes very short and heat generation quickly increases. Thus, we generally recommend that the clearance be slightly positive (slightly above zero) during operation. The bearing clearance after mounting should be decided while considering the reduction in clearance caused by the temperature difference between inner and outer rings during operation and thermal expansion of the shaft and housing in the axial direction.

In practice, clearances C1 or C2 are frequently adopted, as detailed in Table 8.17 on Page A173. In addition, the relationship between radial clearance Δ_r and axial clearance Δ_a is as follows:

$$\Delta_a = \Delta_r \cot \alpha \approx \Delta_r \frac{1.5}{e}$$

where α : Contact angle
 e : Constant determined for each bearing No. (listed in the bearing tables of this catalog)

Tapered roller bearings, which are used for head spindles of machine tools, automotive final reduction gears, etc., are set to a negative clearance for the purpose of obtaining bearing rigidity. This method is called a preload. There are two different types of preloading: constant-pressure preload and the more commonly used position preload.

There are two methods of position preload: one uses an already adjusted arrangement of bearings, while the other achieves the specified preload by tightening an adjustment nut or using an adjustment shim.

Constant pressure preload applies the appropriate preload to the bearing by means of a spring, hydraulic pressure, etc.

Fig. 8.28 shows an automotive final reduction gear.

For pinion gears, preload is adjusted by use of an inner ring spacer and shim. For large gears on the other hand, preload is controlled by the tightening torque of the outer ring retaining screw.

Fig. 8.29 shows the rear wheel of a truck. In this application, preload is applied by tightening the inner ring in the axial direction with a shaft nut. The preload is controlled by measuring the starting friction moment of the bearing.

Fig. 8.30 shows an example lathe head spindle where preload is controlled by tightening the shaft nut.

Fig. 8.31 shows an example of constant-pressure preload by spring displacement. In this case, the relationship between the spring's preload and displacement is used to establish the constant-pressure preload.

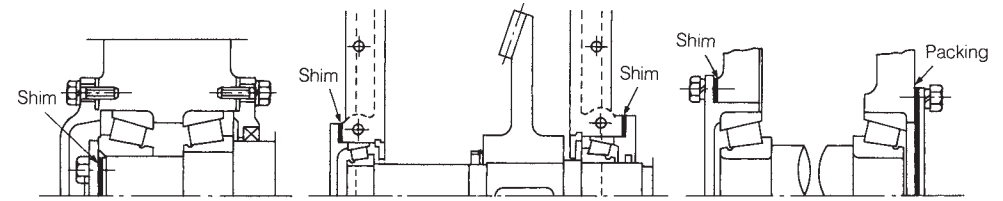

Fig. 8.25 DB Arrangement With Clearance Adjusted by Inner Rings.

Fig. 8.26 DF Arrangement With Clearance Adjusted by Outer Rings.

Fig. 8.27 Clearance Adjusted by Shim Thickness of Outer Ring Cover

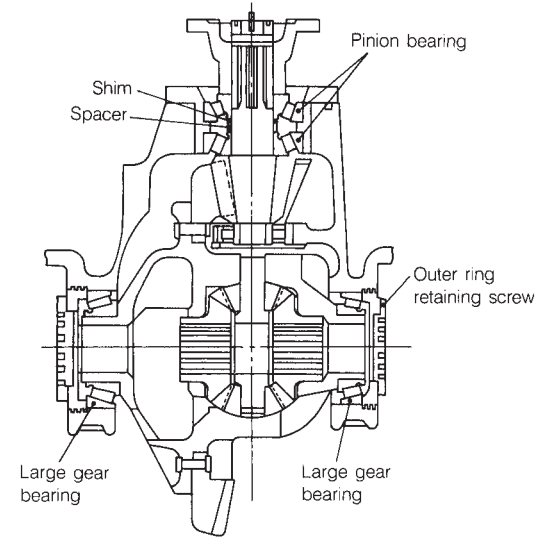

Fig. 8.28 Automotive Final Reduction Gear

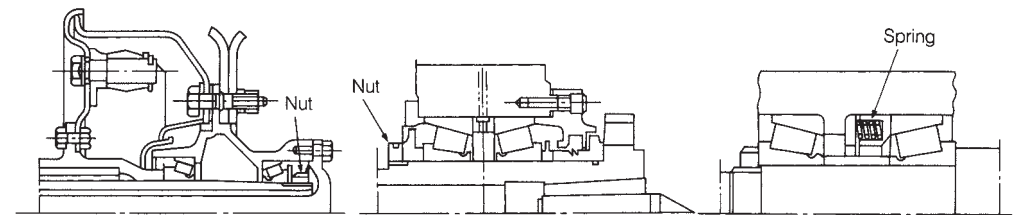

Fig. 8.29 Rear Wheel of Truck

Fig. 8.30 Head Spindle of Lathe

Fig. 8.31 Constant-Pressure Preload Applied by Spring

9. PRELOAD

9.1 Purpose of Preload	A 192
9.2 Preloading Methods	A 192
9.2.1 Position Preload	A 192
9.2.2 Constant-Pressure Preload	A 192
9.3 Preload and Rigidity	A 192
9.3.1 Position Preload and Rigidity	A 192
9.3.2 Constant-Pressure Preload and Rigidity	A 193
9.4 Selection of Preloading Method and Amount of Preload	A 193
9.4.1 Comparison of Preloading Methods	A 193
9.5 Amount of Preload	A 194
9.5.1 Average Preload for Paired Mounting Angular Contact Ball Bearings	A 194
9.5.2 Preload of Thrust Ball Bearings	A 198
9.5.3 Preload of Spherical Thrust Roller Bearings	A 198
9.6 Technical Data	A 200
9.6.1 Load and Displacement of Position-Preloaded Bearings	A 200
9.6.2 Axial Displacement of Deep Groove Ball Bearings ...	A 208
9.6.3 Axial Displacement of Tapered Roller Bearings	A 212

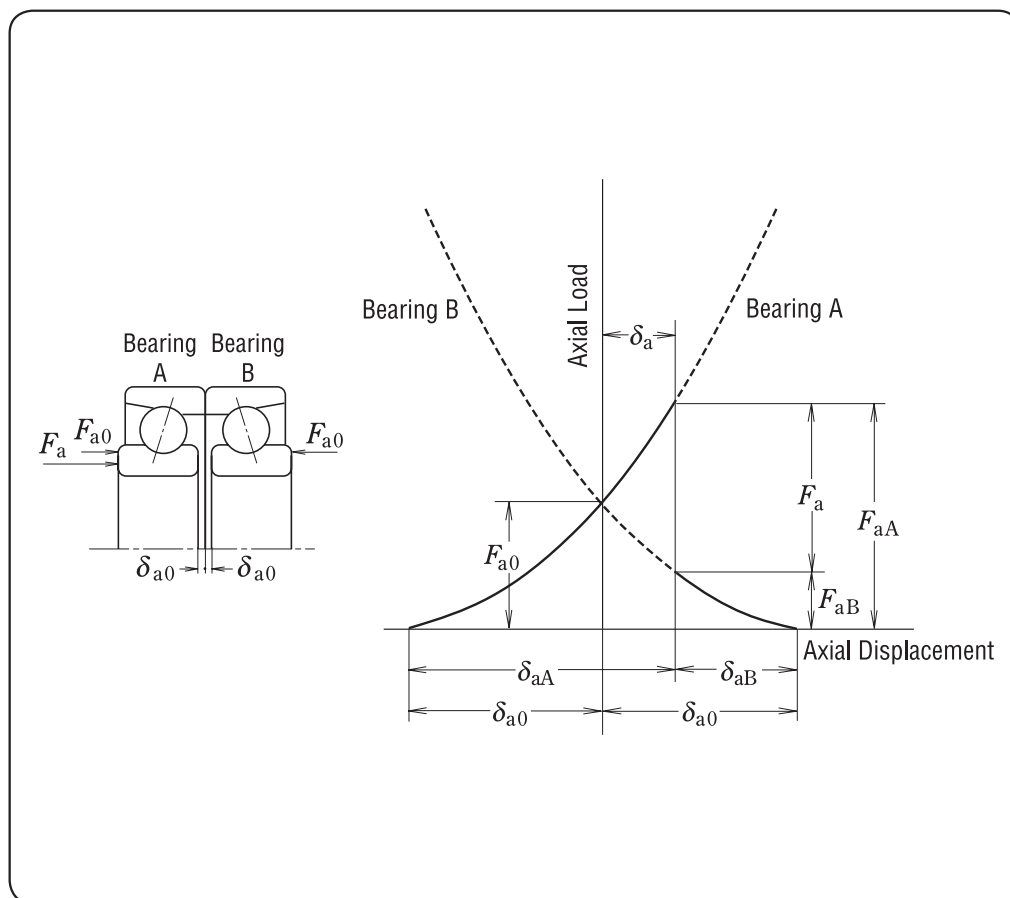

9. PRELOAD

Rolling bearings usually retain some internal clearance while in operation. In some cases however, a negative clearance is desirable to keep them internally stressed. This is called "preloading". A preload is usually applied to bearings whose clearance can be adjusted during mounting, such as angular contact ball bearings or tapered roller bearings. Usually, two bearings are mounted face-to-face or back-to-back to form a paired mounting with a preload.

9.1 Purpose of Preload

The main purposes and some typical applications of preloaded bearings are as follows:

- (1) To maintain the bearings in an exact position both radially and axially and to maintain the running accuracy of the shaft.
Applications: Main shafts of machine tools, precision instruments, etc.
- (2) To increase bearing rigidity
Applications: Main shafts of machine tools, pinion shafts of final drive gears of automobiles, etc.
- (3) To minimize noise due to axial vibration and resonance
Applications: Small electric motors, etc.
- (4) To prevent sliding between the rolling elements and raceways due to gyroscopic moments
Applications: High speed or high acceleration applications of angular contact ball bearings and thrust ball bearings
- (5) To maintain the rolling elements in their proper position with the bearing rings
Applications: Thrust ball bearings and spherical thrust roller bearings mounted on a horizontal shaft

9.2 Preloading Methods

9.2.1 Position Preload

A position preload is achieved by fixing two axially opposed bearings in such a way that a preload is imposed on them. Their position, once fixed, remains unchanged while in operation. In practice, the following three methods are generally used to obtain a position preload:

- (1) Installing a paired mounting with previously adjusted stand-out dimensions (see Page A007, Fig. 1.1) and axial clearance.
- (2) Using spacers or shims that have been specifically sized to obtain the required spacing and preload. (refer to Fig. 9.1)
- (3) Utilizing bolts or nuts to allow adjustment of the axial preload. In this case, the starting torque should be measured to verify the proper preload.

9.2.2 Constant-Pressure Preload

A constant-pressure preload is achieved by using a coil or leaf spring to impose a constant preload. Even if the relative position of the bearings changes during operation, the spring ensures that the magnitude of the preload remains relatively constant (refer to Fig. 9.2).

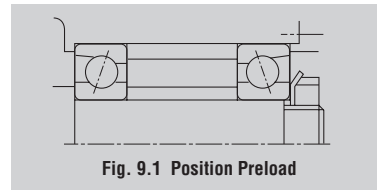

Fig. 9.1 Position Preload

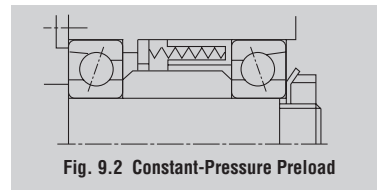

Fig. 9.2 Constant-Pressure Preload

9.3 Preload and Rigidity

9.3.1 Position Preload and Rigidity

The inner rings of Bearing A and B in the paired mounting shown in Fig. 9.3 are each displaced by δ_{a0} . When they are fixed axially, this total displacement $2\delta_{a0}$ is eliminated. Under this condition, preload F_{a0} is imposed on each bearing. A preload diagram showing bearing rigidity, or the relation between load and displacement with given axial load F_a imposed on a paired mounting, is shown in Fig. 9.4.

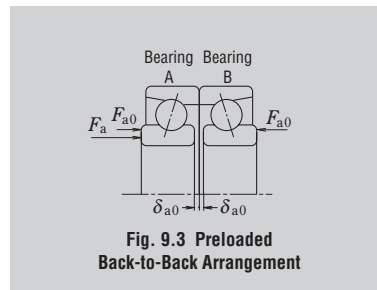

Fig. 9.3 Preloaded Back-to-Back Arrangement

9.3.2 Constant-Pressure Preload and Rigidity

A preload diagram for paired mountings under constant-pressure preload is shown in Fig. 9.5. The deflection curve of the spring is nearly parallel to the horizontal axis because the rigidity of the spring is lower than that of the bearing. As a result, rigidity under a constant-pressure preload is approximately equal to that of a single bearing with a preload F_{a0} applied to it. Fig. 9.6 presents a comparison of rigidity between a bearing with a position preload and one with a constant-pressure preload.

9.4 Selection of Preloading Method and Amount of Preload

9.4.1 Comparison of Preloading Methods

A comparison of the rigidity of both preloading methods is shown in Fig. 9.6. The position preload and constant-pressure preload may be compared as follows:

- (1) When both of the preloads are equal, the position preload provides greater bearing rigidity. In other words, bearings with a position preload experience less deflection due to external loads.
- (2) Under position preload, the amount of preload varies depending on such factors as differences in axial expansion due to temperature differences between the shaft and housing, differences in radial expansion due to temperature differences between the inner and outer rings, deflection due to load, etc.

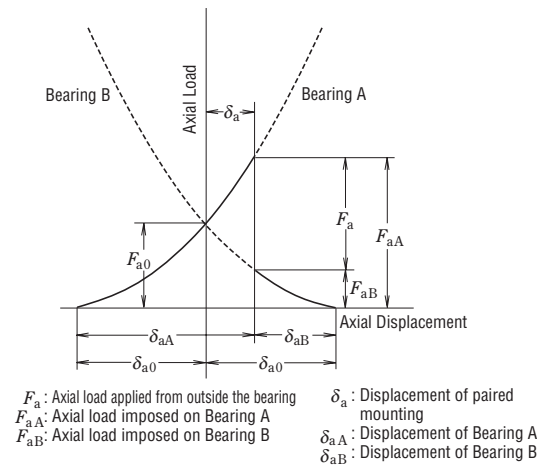

Fig. 9.4 Axial Displacement With Position Preload

Under constant-pressure preload, it is possible to minimize change in the amount of preload because the variation of the spring load with shaft expansion and contraction is negligible. Thus, position preloads are generally preferred for increasing rigidity and constant-pressure preloads are more suitable for high-speed applications, prevention of axial vibration, use with thrust bearings on horizontal shafts, etc.

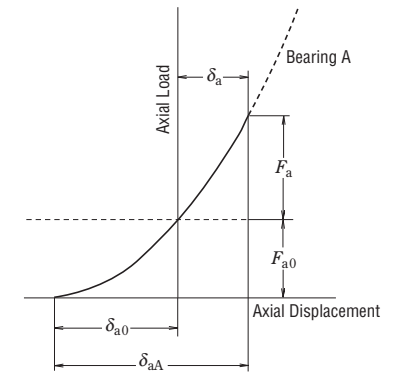

Fig. 9.5 Axial Displacement With Constant-Pressure Preload

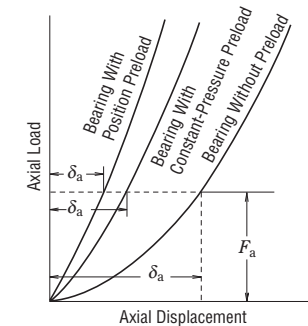

Fig. 9.6 Comparison of Rigidities and Preloading Methods

9.5 Amount of Preload

If the preload is larger than necessary, abnormal heat generation, increased frictional torque, reduced fatigue life, or other negative effects may occur. The amount of the preload should be carefully determined considering the operating conditions and the purpose of the preload.

9.5.1 Average Preload for Duplex Angular Contact Ball Bearings

Angular contact ball bearings are widely used in spindles for grinding, milling, high-speed turning, and similar applications. NSK divides preloads into four graduated classifications—Extra light, Light, Medium, and Heavy—to allow the customer to freely choose the appropriate preload for the specific application. These four preload classes are expressed by codes EL, L, M, and H respectively when applied to DB and DF bearing sets.

The average preload and measured axial clearance for paired mounting angular contact ball bearing sets with contact angles of 15° and 30° (widely used on machine tool spindles) are given in Tables 9.3 to 9.5. The measuring load when measuring axial clearance is shown in Table 9.1.

The recommended axial clearance to achieve proper preload was determined for machine-tool spindles and other applications requiring ISO Class 5 and above high-precision bearing sets. The standard values given in Table 9.2 are used for the shaft/inner ring and housing/outer ring fits. Housing fits should be selected from the lower part of the standard clearance range for bearings in fixed-end applications and the higher part of the standard clearance range in free-end applications.

As a general rule, grinding machine spindles or machining center spindles require extra light to light preloads, whereas lathe spindles, which need rigidity, require medium preloads.

If the bearing set is mounted with a tight fit, preloads are greater than those shown in Tables 9.3 to 9.5. Since excessive preload causes bearing temperature rise and increases the risk of seizure among other negative effects, pay careful attention to fitting. When speeds result in a value of $D_{pw} \cdot n$ ($d_m n$ value) higher than 500 000, the preload should be very carefully studied and selected. In such a case, please consult with NSK before bearing selection.

Table 9.1 Measuring Load for Axial Clearance

Nominal Outside Diameter <i>D</i> (mm)		Measuring Load (N)
over	incl	
10*	50	24.5
50	120	49
120	200	98
200	—	196

*10 mm is included in this range.

Table 9.2 Target Fitting

Units : μm

Bore or Outside Diameter <i>d</i> or <i>D</i> (mm)		Shaft and Inner Ring	Housing and Outer Ring
over	incl	Target Interference	Target Clearance
—	18	0 to 2	—
18	30	0 to 2.5	2 to 6
30	50	0 to 2.5	2 to 6
50	80	0 to 3	3 to 8
80	120	0 to 4	3 to 9
120	150	—	4 to 12
150	180	—	4 to 12
180	250	—	5 to 15

Table 9.3 Average Preload and Axial Clearance for Series 79C Bearings

Bearing Designation	Extra Light EL		Light L		Medium M		Heavy H	
	Preload	Axial Clearance	Preload	Axial Clearance	Preload	Axial Clearance	Preload	Axial Clearance
	(N)	(μm)	(N)	(μm)	(N)	(μm)	(N)	(μm)
7900C	7	5	16	2	29	-1	58	-6
7901C	8.6	4	16	2	41	-3	77	-8
7902C	12	3	25	0	47	-4	104	-11
7903C	11	3	25	0	56	-5	119	-12
7904C	20	1	42	-3	80	-8	152	-15
7905C	19	1	37	-2	99	-9	203	-17
7906C	25	0	46	-3	95	-8	204	-16
7907C	33	2	67	-2	149	-9	297	-18
7908C	41	1	78	-3	196	-12	384	-22
7909C	49	0	104	-5	192	-11	391	-21
7910C	49	0	95	-4	240	-13	499	-24
7911C	60	-1	111	-5	296	-15	593	-26
7912C	60	-1	113	-5	305	-15	581	-25
7913C	74	-2	151	-7	348	-16	690	-27
7914C	101	-4	205	-10	503	-22	1 004	-36
7915C	103	-4	190	-9	489	-21	997	-35
7916C	104	-4	195	-9	503	-21	986	-34
7917C	138	-6	307	-14	629	-25	1 281	-41
7918C	153	-3	289	-9	740	-23	1 488	-39
7919C	154	-3	294	-9	800	-24	1 588	-40
7920C	191	-5	387	-13	905	-28	1 790	-46

Remark The axial clearance column contains measured values.

Table 9.4 Average Preload and Axial Clearance for Series 70C Bearings

Bearing Designation	Extra Light EL		Light L		Medium M		Heavy H	
	Preload	Axial Clearance	Preload	Axial Clearance	Preload	Axial Clearance	Preload	Axial Clearance
	(N)	(μm)	(N)	(μm)	(N)	(μm)	(N)	(μm)
7000C	13	3	25	0	49	-5	96	-12
7001C	13	3	25	0	57	-6	120	-14
7002C	12	3	29	-1	66	-7	147	-16
7003C	15	2	30	-1	69	-7	156	-16
7004C	25	0	49	-4	119	-12	244	-22
7005C	30	-1	58	-5	148	-14	292	-24
7006C	41	1	75	-3	195	-13	386	-24
7007C	58	-1	121	-7	251	-16	493	-28
7008C	58	-1	114	-6	291	-17	594	-30
7009C	80	-3	144	-8	338	-19	695	-33
7010C	70	-2	152	-8	388	-20	791	-34
7011C	95	-4	200	-11	479	-24	971	-40
7012C	96	-4	189	-10	526	-25	1 092	-42
7013C	130	-6	260	-13	537	-24	1 062	-39
7014C	148	-7	285	-14	732	-30	1 460	-48
7015C	151	-7	294	-14	796	-31	1 573	-49
7016C	202	-6	382	-14	921	-31	1 880	-52
7017C	205	-6	393	-14	995	-32	1 956	-52
7018C	247	-8	502	-18	1 187	-37	2 373	-60
7019C	275	-9	549	-19	1 188	-36	2 348	-58
7020C	282	-9	534	-18	1 278	-37	2 572	-60

Remark The axial clearance column contains measured values.

Table 9.5 Average Preload and Axial Clearance for Series 72C Bearings

Bearing Designation	Extra Light EL		Light L		Medium M		Heavy H	
	Preload	Axial Clearance	Preload	Axial Clearance	Preload	Axial Clearance	Preload	Axial Clearance
	(N)	(μm)	(N)	(μm)	(N)	(μm)	(N)	(μm)
7200C	13	3	29	-1	68	-8	150	-18
7201C	20	1	39	-3	99	-12	197	-22
7202C	20	1	40	-3	97	-11	199	-21
7203C	25	0	46	-4	146	-16	296	-28
7204C	35	-2	68	-7	196	-20	384	-33
7205C	42	1	82	-4	193	-14	402	-27
7206C	57	-1	114	-7	292	-20	591	-35
7207C	75	-3	151	-10	385	-25	794	-43
7208C	98	-5	202	-13	501	-29	985	-47
7209C	123	-7	254	-16	534	-30	1 067	-49
7210C	127	-7	248	-15	590	-31	1 171	-50
7211C	142	-8	289	-17	788	-38	1 554	-60
7212C	190	-11	397	-22	928	-42	1 878	-67
7213C	219	-12	448	-23	1 069	-44	2 175	-70
7214C	243	-9	484	-20	1 164	-42	2 368	-69
7215C	270	-10	530	-21	1 224	-42	2 445	-68
7216C	305	-12	595	-24	1 367	-47	2 752	-76
7217C	355	-14	697	-27	1 658	-53	3 358	-85
7218C	384	-15	771	-29	1 865	-57	3 713	-90
7219C	448	-18	876	-33	2 081	-63	4 153	-99
7220C	503	-20	984	-36	2 337	-68	4 700	-107

Remark The axial clearance column contains measured values.

9.5.2 Preload of Thrust Ball Bearings

When the balls in thrust ball bearings rotate at relatively high speeds, sliding due to gyroscopic moments on the balls may occur. The larger of the two values obtained from Equations (9.1) and (9.2) below should be adopted as the minimum axial load in order to prevent such sliding:

$$F_{a \min} = \frac{C_{0a}}{100} \left(\frac{n}{N_{\max}} \right)^2 \dots\dots\dots (9.1)$$

$$F_{a \min} = \frac{C_{0a}}{1000} \dots\dots\dots (9.2)$$

where $F_{a \min}$: Minimum axial load (N), {kgf}
 C_{0a} : Basic static load rating (N), {kgf}
 n : Speed (min^{-1})
 N_{\max} : Limiting speed (oil lubrication) (min^{-1})

9.5.3 Preload of Spherical Thrust Roller Bearings

When spherical thrust roller bearings are used, damage such as scoring may occur due to sliding between the rollers and outer ring raceway. The minimum axial load $F_{a \min}$ necessary to prevent such sliding is obtained from the following equation:

$$F_{a \min} = \frac{C_{0a}}{1000} \dots\dots\dots (9.3)$$

9.6 Technical Data

9.6.1 Load and Displacement of Position-Preloaded Bearings

Bearing arrangements refer to multiple identical ball or tapered roller bearings mounted side by side as a set. When two bearings are used, they are often referred to as paired mountings or duplex bearings.

In bearing arrangements for machine tool spindles, single-row angular contact ball bearings are most often used for their high rigidity to reduce bearing displacement under load.

Paired mountings fall into three types: back-to-back, with load lines that diverge toward the bearing axis; face-to-face, with load lines that converge toward the bearing axis; and tandem, with parallel load lines. The designations for these arrangements are DB, DF, and DT respectively (Fig. 9.7).

Different arrangements are used depending on the application. DB and DF arrangements can take axial loads in either direction. Since the distances of the load centers of DB arrangements are longer than those of DF arrangements, they are widely used in applications where moment loads occur. DT arrangements can only take axial loads in one direction; however, because the two bearings share load equally between them, this type can be used when load in one direction is large.

By selecting DB or DF arrangements preset with proper preloads, radial and axial displacement of the bearing inner and outer rings can be reduced as much as possible (DT arrangements can not be preloaded in this way). The amount of preload can be adjusted by changing the clearance between bearings δ_{a0} , as shown in Figs. 9.9 to 9.11. Preloads are divided into four graduated classifications: Extra Light (EL), Light (L), Medium (M), and Heavy (H). DB and DF arrangements are often used for applications where shaft misalignments and displacements due to load must be minimized. Arrangements of three bearings (triplex) are designated DBD, DFD, and DTD, as shown in Fig. 9.8. Sets of four or five bearings can also be used depending on application requirements. Paired mountings are often used with a preload. Since preload affects various things, such as the rise in bearing temperature during operation, torque, bearing noise, and especially bearing life, it is extremely important to avoid applying excessive preload.

$$\delta_a = c F_a^{2/3} \dots\dots\dots (9.4)$$

where c : Constant depending on the bearing type and dimensions.

Fig. 9.9 shows the preload curves of a DB arrangement, and Figs. 9.10 and 9.11 show preload curves for a DBD arrangement. If the inner rings of a paired mounting as in Fig. 9.9 are pressed axially, A-side and B-side bearings are deformed by δ_{a0A} and δ_{a0B} respectively and the clearance (between the inner rings) δ_{a0} becomes zero. This condition means that preload F_{a0} is applied on the arrangement. If external axial load F_a is applied on the preloaded arrangement from the A-side, then the A-side bearing will be deformed by an additional δ_{a1} and the displacement of B-side bearing will be reduced to the same amount as the A-side bearing displacement δ_{a1} . Therefore, the displacements of A- and B-side bearings are $\delta_{aA} = \delta_{a0A} + \delta_{a1}$ and $\delta_{aB} = \delta_{a0B} + \delta_{a1}$ respectively. In other words, the load on the A-side bearing including preload is $F_{a0} + F_a - F_a'$ and that on the B-side is $F_{a0} - F_a'$.

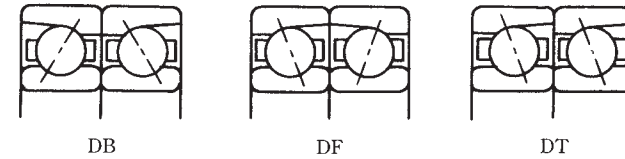

Fig. 9.7 Paired Mounting Bearing Arrangements

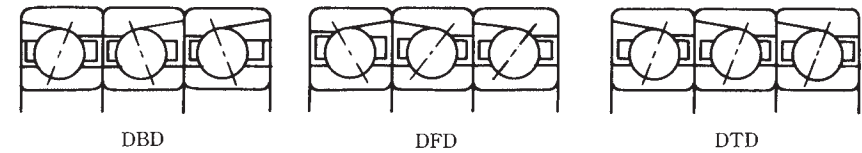

Fig. 9.8 Triplex Bearing Arrangements

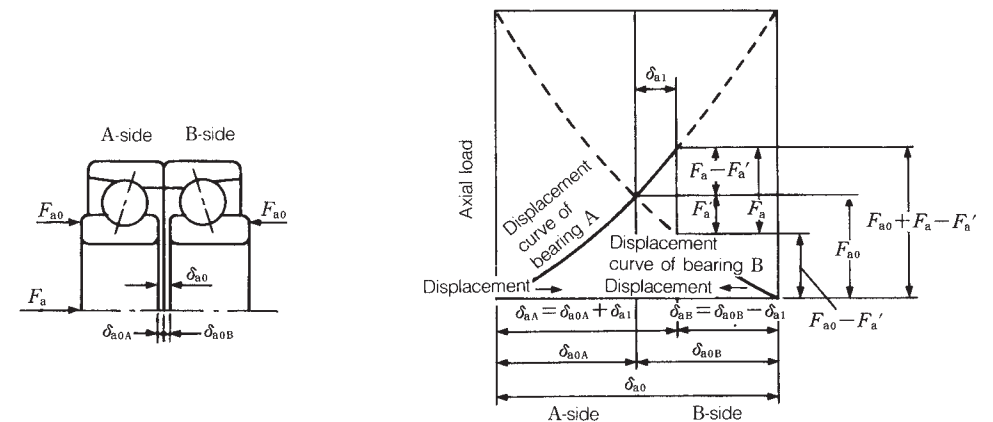

Fig. 9.9 Preload Graph of DB Back-to-Back Arrangement

If the bearing set has an applied preload, the A-side bearing should have sufficient life and load capacity for an axial load ($F_{a0} + F_a - F'_a$) under operating speed conditions. The axial clearance δ_{a0} is shown in Tables 9.3 to 9.5 of Section 9.5.1 (Pages A195 to A197).

Fig. 9.10 shows external axial load F_a applied on AA-side bearings. The axial loads and displacements of AA- and B-side bearings are summarized in Table 9.6.

Fig. 9.11 shows external axial load F_a applied on an A-side bearing. The axial loads and displacements of A- and BB-side bearings are summarized in Table 9.7.

Figs. 9.12 to 9.17 show the relationship of axial load to axial displacement for DB and DBD arrangements of 7018C and 7018A bearings under several preload ranges.

Table 9.6

Direction	Displacement	Axial load
AA-side	$\delta_{a0A} + \delta_{a1}$	$F_{a0} + F_a - F'_a$
B-side	$\delta_{a0B} - \delta_{a1}$	$F_{a0} - F'_a$

Table 9.7

Direction	Displacement	Axial load
A-side	$\delta_{a0A} + \delta_{a1}$	$F_{a0} + F_a - F'_a$
BB-side	$\delta_{a0B} - \delta_{a1}$	$F_{a0} - F'_a$

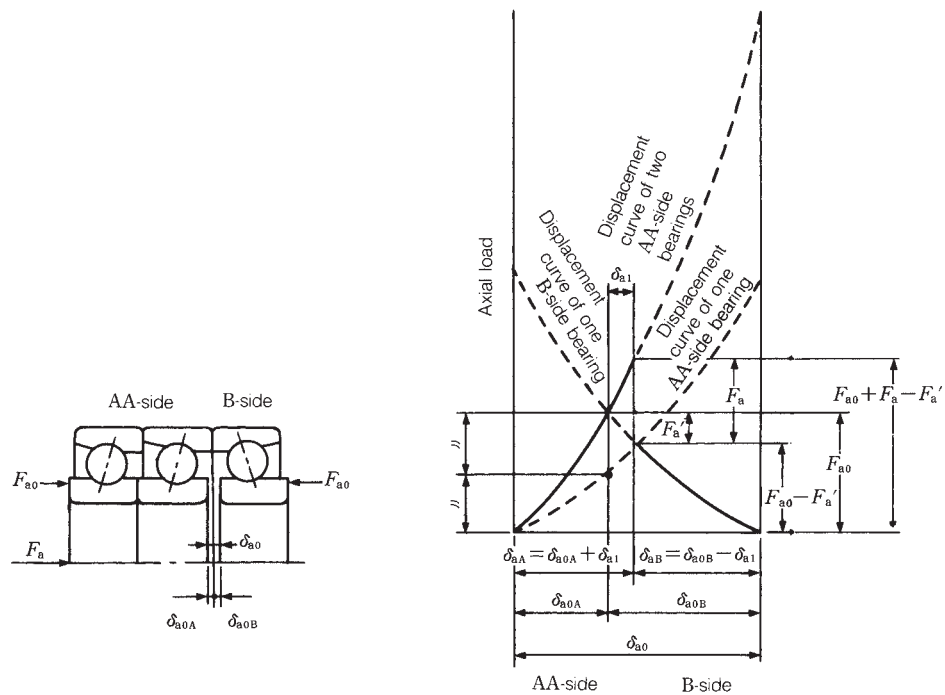

Fig. 9.10 Preload Graph for a DBD Arrangement (Axial Load Applied From the AA-Side)

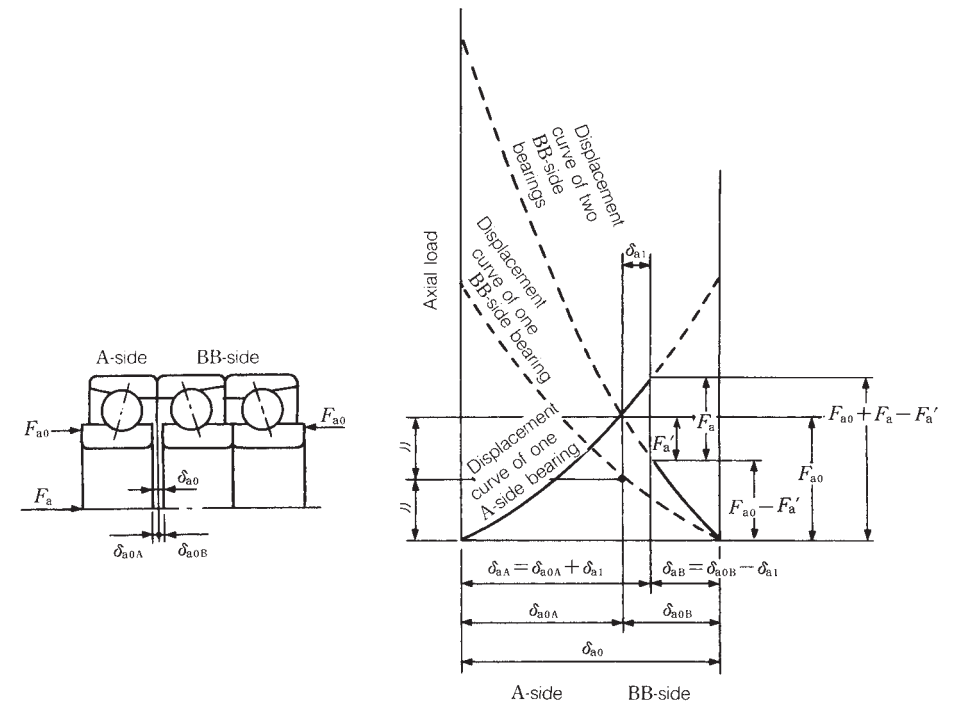

Fig. 9.11 Preload Graph for a DBD Arrangement (Axial Load Applied From A-Side)

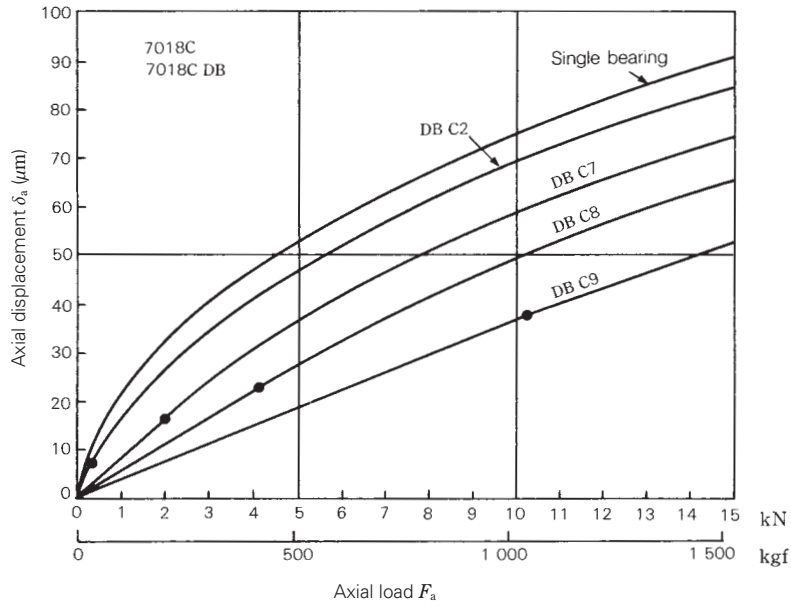

Fig. 9.12

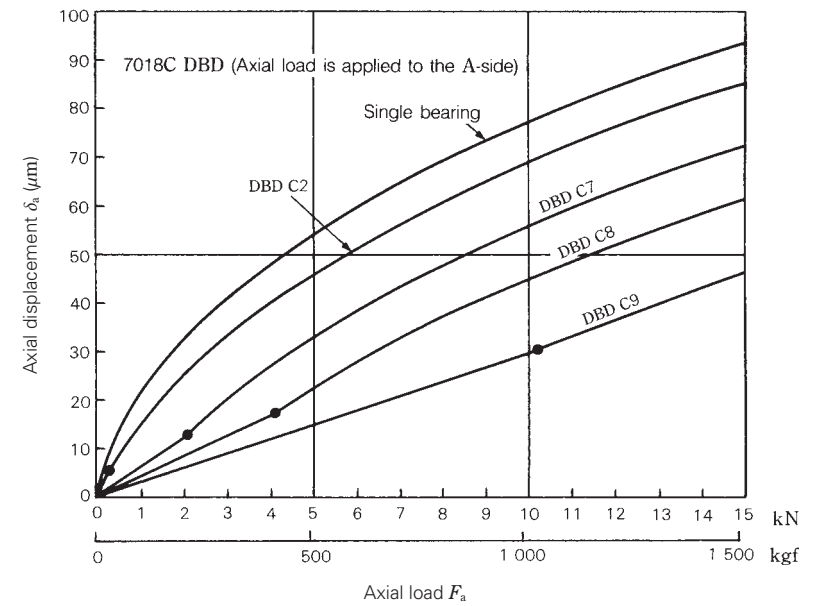

Fig. 9.14

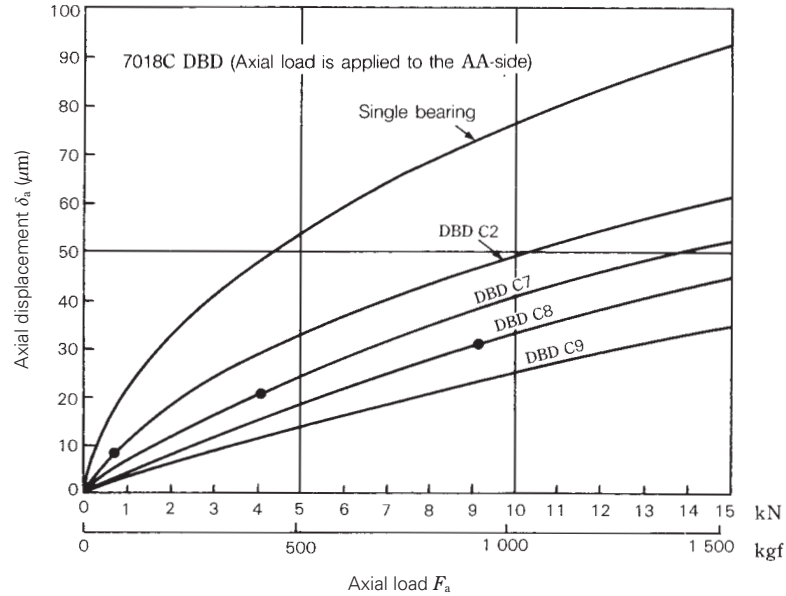

Fig. 9.13

Remark The (•) mark on the axial load or displacement curve indicates the point where the preload is zero. Therefore, if the axial load is larger than this, the opposed bearing does not impose a load.

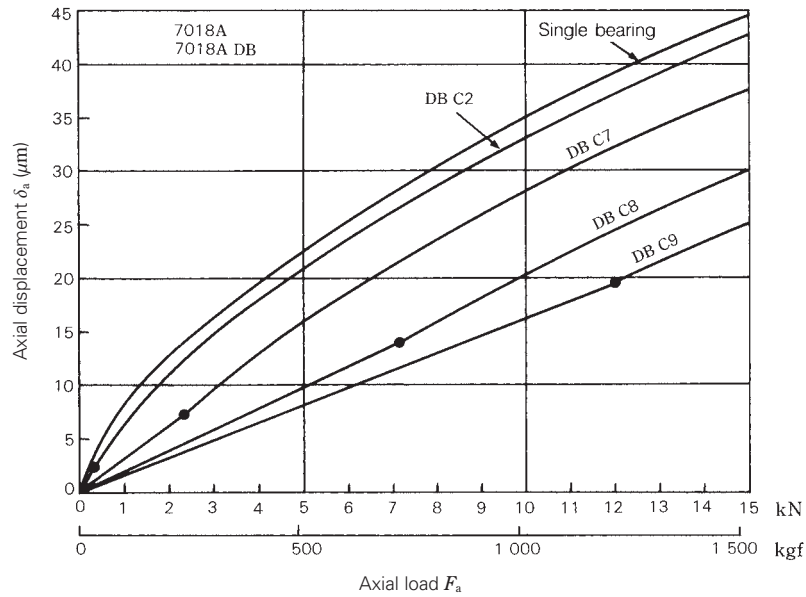

Fig. 9.15

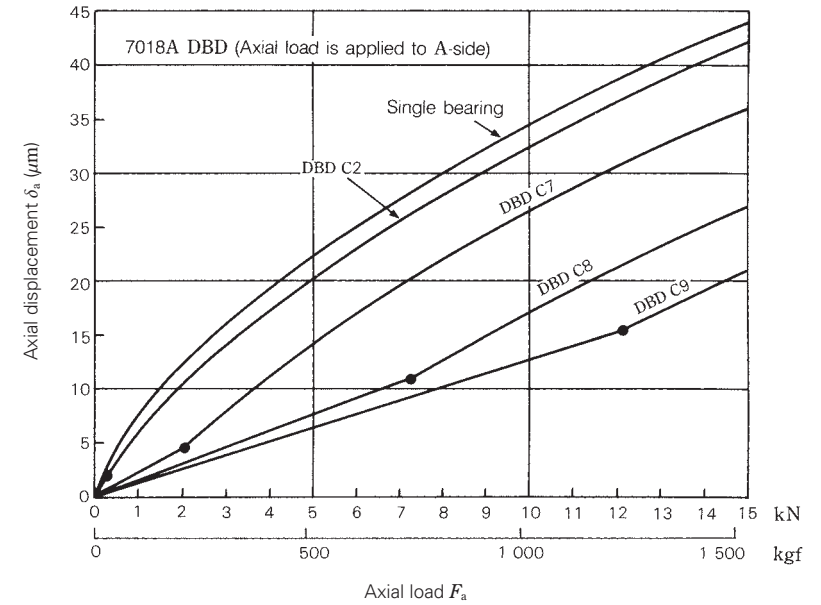

Fig. 9.17

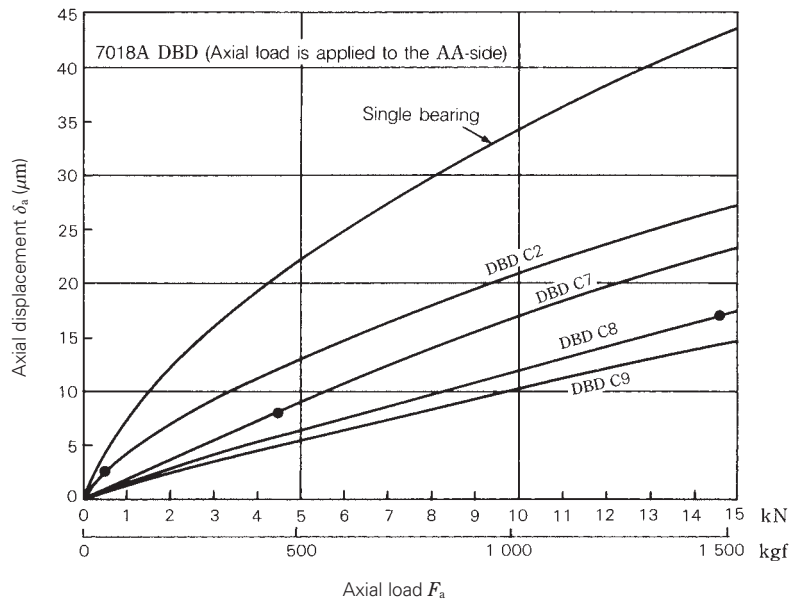

Fig. 9.16

Remark The (•) mark on the axial load or displacement curve indicates the point where the preload is zero. Therefore, if the axial load is larger than this, the opposed bearing does not impose a load.

9.6.2 Axial Displacement of Deep Groove Ball Bearings

When an axial load F_a is applied to a radial bearing with contact angle α_0 and the inner ring is displaced δ_a , the center of the inner ring raceway radius O_i is also moved to O_i' resulting in contact angle α as shown in Fig. 9.18. If δ_N represents the elastic deformation of the raceway and ball in the direction of the rolling element load Q , Equation (9.5) is derived from Fig. 9.18.

$$(m_0 + \delta_N)^2 = (m_0 \cdot \sin \alpha_0 + \delta_a)^2 + (m_0 \cdot \cos \alpha_0)^2$$

$$\therefore \delta_N = m_0 \left\{ \sqrt{(\sin \alpha_0 + \frac{\delta_a}{m_0})^2 + \cos^2 \alpha_0} - 1 \right\} \dots \dots \dots (9.5)$$

In addition, the following relationship exists between rolling element load Q and elastic deformation δ_N .

$$Q = K_N \cdot \delta_N^{3/2} \dots \dots \dots (9.6)$$

where K_N : Constant depending on bearing material, type, and dimensions
If we introduce the relation of

$$m_0 = \left(\frac{r_e}{D_w} + \frac{r_i}{D_w} - 1 \right) D_w = B \cdot D_w$$

Equations (9.5) and (9.6) are

$$Q = K_N (B \cdot D_w)^{3/2} \left\{ \sqrt{(\sin \alpha_0 + h)^2 + \cos^2 \alpha_0} - 1 \right\}^{3/2}$$

where $h = \frac{\delta_a}{m_0} = \frac{\delta_a}{B \cdot D_w}$

If we introduce the relation of $K_N = K \cdot \frac{\sqrt{D_w}}{B^{3/2}}$

$$Q = K \cdot D_w^2 \left\{ \sqrt{(\sin \alpha_0 + h)^2 + \cos^2 \alpha_0} - 1 \right\}^{3/2} \dots \dots \dots (9.7)$$

On the other hand, the relation between bearing axial load and rolling element load is shown in Equation (9.8) using Fig. 9.19:

$$F_a = Z \cdot Q \cdot \sin \alpha \dots \dots \dots (9.8)$$

Based on Fig. 9.18, we obtain,

$$(m_0 + \delta_N) \sin \alpha = m_0 \cdot \sin \alpha_0 + \delta_a$$

$$\therefore \sin \alpha = \frac{m_0 \cdot \sin \alpha_0 + \delta_a}{m_0 + \delta_N} = \frac{\sin \alpha_0 + h}{1 + \frac{\delta_N}{m_0}}$$

If we substitute Equation (9.5),

$$\sin \alpha = \frac{\sin \alpha_0 + h}{\sqrt{(\sin \alpha_0 + h)^2 + \cos^2 \alpha_0}} \dots \dots \dots (9.9)$$

In other words, the relation between the bearing axial load F_a and axial displacement δ_a can be obtained by substituting Equations (9.7) and (9.9) for Equation (9.8).

$$F_a = K \cdot Z \cdot D_w^2 \cdot \frac{\left\{ \sqrt{(\sin \alpha_0 + h)^2 + \cos^2 \alpha_0} - 1 \right\}^{3/2} \times (\sin \alpha_0 + h)}{\sqrt{(\sin \alpha_0 + h)^2 + \cos^2 \alpha_0}} \dots \dots \dots (9.10)$$

- where K : Constant depending on bearing material and design
 - D_w : Ball diameter
 - Z : Number of balls
 - α_0 : Initial contact angle
- The initial contact angle for single-row deep groove ball bearings can be obtained using Equation (5) on Page C012

Actual axial deformation varies depending on bearing mounting conditions and factors such as the material and thickness of the shaft and housing and bearing fitting. For more details, consult with NSK.

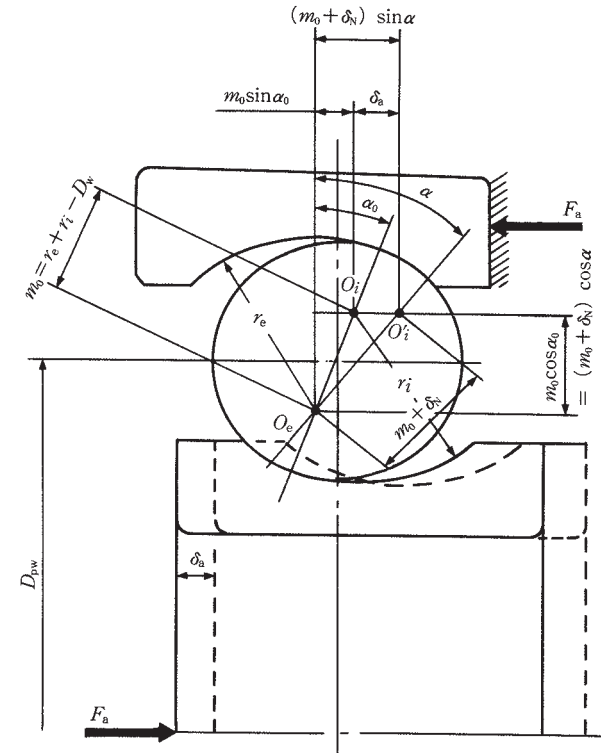

Fig. 9.18

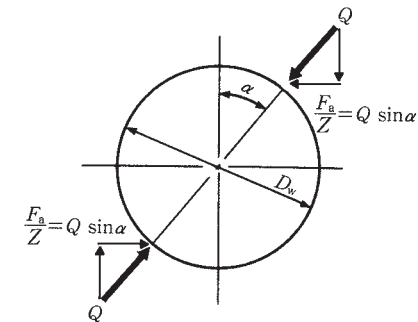

Fig. 9.19

Fig. 9.20 shows the relation between axial load and axial displacement for Series 6210 and 6310 single-row deep groove ball bearings with initial contact angles of 0°, 10°, and 15°. The larger the initial contact angle α_0 , the more rigid the bearing will be in the axial direction and the smaller the difference between the axial displacements of 6210 and 6310 under identical axial load. The initial contact angle α_0 depends on the groove radius and the radial clearance.

Fig. 9.21 shows the relation between axial load and axial displacement for Series 72 angular contact ball bearings with initial contact angles of 15° (C), 30° (A), and 40° (B). Series 70 and 73 bearings with identical contact angles and bore diameters can be considered to have almost the same values as Series 72 bearings. Angular contact ball bearings that sustain loads in the axial direction must maintain their running accuracy and reduce elastic deformation from applied loads when used as multiple bearing arrangements with a preload.

To determine the preload to keep the elastic deformation caused by applied loads within the required limits, it is important to know the characteristics of load vs. deformation. The relationship between load and displacement can be expressed by Equation (9.10) as $F_a \propto \delta_a^{3/2}$ or $\delta_a \propto F_a^{2/3}$. In other words, axial displacement δ_a is proportional to axial load F_a to the 2/3 power. When this axial load index is less than one, relative axial displacement will be small, with only a small increase in axial load (Fig. 9.21). The underlying reason for applying a preload is to reduce the amount of displacement.

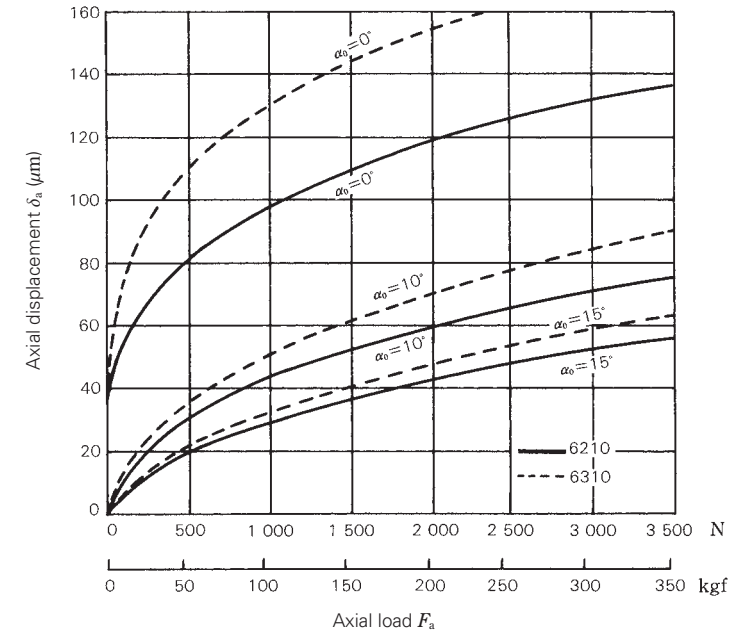

Fig. 9.20 Axial Load and Axial Displacement of Deep Groove Ball Bearings

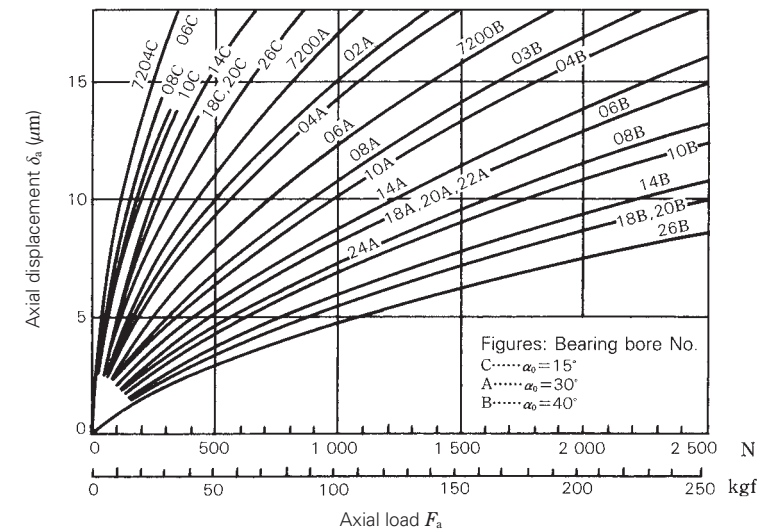

Fig. 9.21 Axial Load and Axial Displacement of Angular Contact Ball Bearings

9.6.3 Axial Displacement of Tapered Roller Bearings

Tapered roller bearings are widely used in pairs like angular contact ball bearings. Take care when selecting appropriate tapered roller bearings.

For example, the bearings of machine-tool head spindles and automobile differential pinions are preloaded to increase shaft rigidity.

When a bearing with an applied preload is to be used, it is essential to have some knowledge of the relationship between axial load and axial displacement. For tapered roller bearings, the axial displacement calculated using Palmgren's method in Equation (9.11) generally agrees well with actual measured values.

Actual axial deformation varies depending on the bearing mounting conditions, such as the material and thickness of the shaft and housing and the bearing fitting. For more details, consult with NSK.

$$\delta_a = \frac{0.000077}{\sin\alpha} \cdot \frac{Q^{0.9}}{L_{we}^{0.8}} \quad (N) \quad \dots (9.11)$$

$$= \frac{0.0006}{\sin\alpha} \cdot \frac{Q^{0.9}}{L_{we}^{0.8}} \quad \{kgf\}$$

where, δ_a : Axial displacement of inner, outer ring (mm)

α : Contact angle...1/2 the outer ring angle (°) (Refer to Fig. 9.22)

Q : Load on rolling elements (N), {kgf}

$$Q = \frac{F_a}{Z \sin\alpha}$$

L_{we} : Length of effective contact on roller (mm)

F_a : Axial load (N), {kgf}

Z : Number of rollers

Equation (9.11) can also be expressed as Equation (9.12).

$$\delta_a = K_a \cdot F_a^{0.9} \quad \dots (9.12)$$

where,

$$K_a = \frac{0.000077}{(\sin\alpha)^{1.9} Z^{0.9} L_{we}^{0.8}} \quad \dots (N)$$

$$= \frac{0.0006}{(\sin\alpha)^{1.9} Z^{0.9} L_{we}^{0.8}} \quad \{kgf\}$$

Here K_a refers to the coefficient determined by bearing internal design.

Axial loads and axial displacement for tapered roller bearings are plotted in Fig. 9.23.

The amount of axial displacement of tapered roller bearings is proportional to the axial load raised to the 0.9 power. The displacement of ball bearings is proportional to the axial load raised to the 0.67 power; thus, the preload required to control displacement is much greater for ball bearings than for tapered roller bearings.

Take caution not to make the preload indiscriminately large on tapered roller bearings, since too large of a preload can cause excessive heat, seizure, and reduced bearing life.

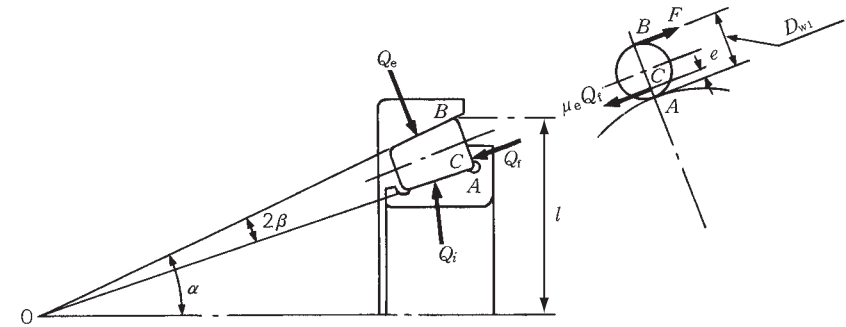

Fig. 9.22

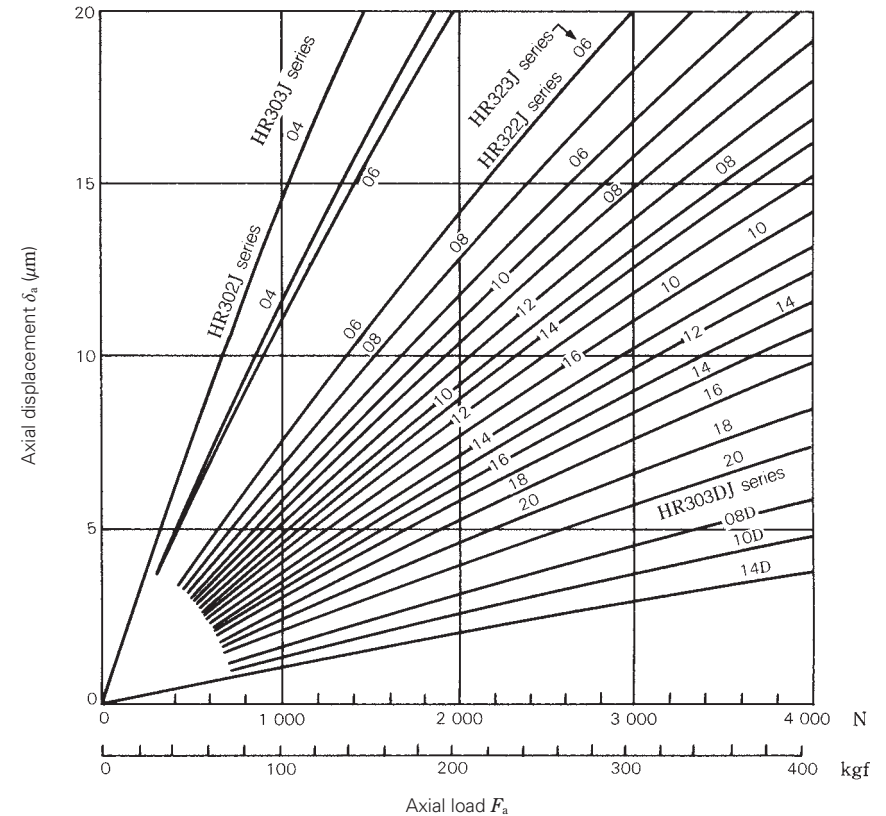
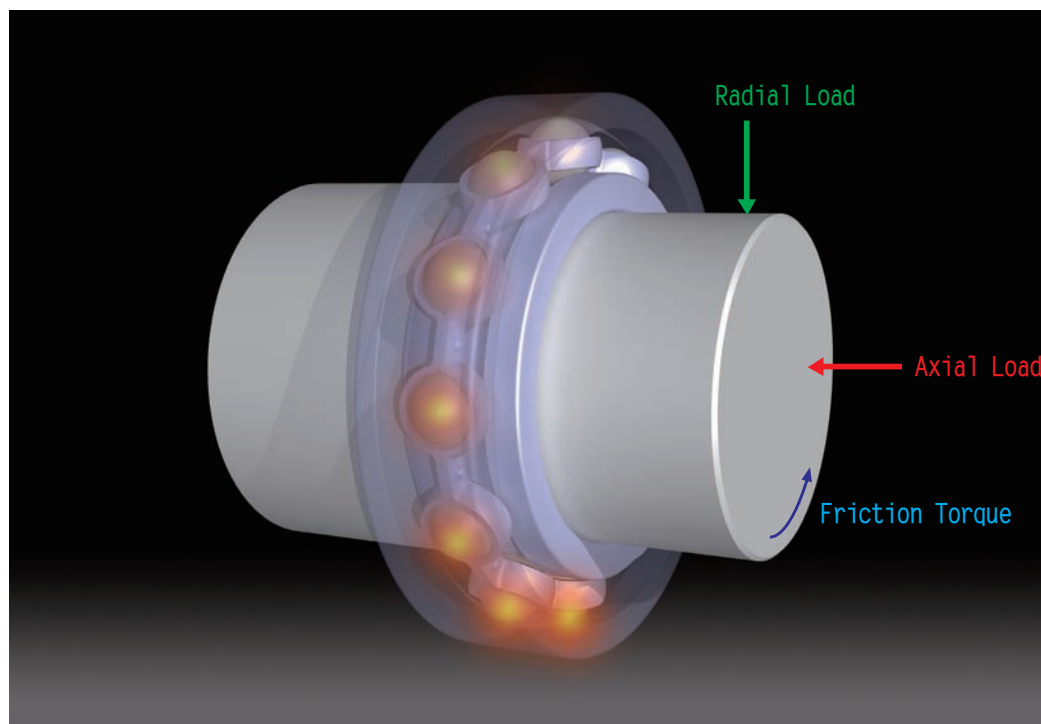

Fig. 9.23 Axial Load and Axial Displacement for Tapered Roller Bearings

10. FRICTION

10.1	Coefficients of Dynamic Friction	A 216
10.1.1	Bearing Types and Their Coefficients of Dynamic Friction	A 216
10.2	Empirical Equations for Running Torque	A 216
10.3	Technical Data	A 216
10.3.1	Preload and Starting Torque for Angular Contact Ball Bearings	A 216
10.3.2	Empirical Equations for Running Torque of High-Speed Ball Bearings	A 218
10.3.3	Preload and Starting Torque for Tapered Roller Bearings	A 220
10.3.4	Empirical Equations for Running Torque of Tapered Roller Bearings	A 222



10. FRICTION

10.1 Coefficients of Dynamic Friction

10.1.1 Bearing Types and Their Coefficients of Dynamic Friction μ

$$\mu = \frac{M}{P \cdot \frac{d}{2}} \quad (10.1)$$

M : Dynamic friction torque (N·mm), {kgf·mm}
 P : Load on a bearing (dynamic equivalent load) (N), {kgf}
 d : Shaft diameter, inner ring bore diameter (mm)

Table 10.1 Coefficients of Dynamic Friction

Bearing Types	Approximate Values of μ
Deep Groove Ball Bearings	0.0013
Angular Contact Ball Bearings	0.0015
Self-Aligning Ball Bearings	0.0010
Thrust Ball Bearings	0.0011
Cylindrical Roller Bearings	0.0010
Tapered Roller Bearings	0.0022
Spherical Roller Bearings	0.0028
Needle Roller Bearings With Cages	0.0015
Full Complement Needle Roller Bearings	0.0025
Spherical Thrust Roller Bearings	0.0028

10.2 Empirical Equations for Running Torque

Dynamic bearing torque (heat generation) $M = M_l + M_v$

Load term (determined by bearing type and load)
 $M_l = f_l F d_m$
 where f_l : Coefficient determined by bearing type and load
 F : Load
 d_m : Pitch circle diameter of rolling element

Speed term (determined by oil viscosity, amount, speed)
 $M_v = f_v (v_0 n)^{2/3} d_m^3$
 where f_v : Coefficient determined by bearing and lubricating method
 v_0 : Kinematic viscosity of oil
 n : Speed

10.3 Technical Data

10.3.1 Preload and Starting Torque for Angular Contact Ball Bearings

Angular contact ball bearings, like tapered roller bearings, are most often used in pairs rather than alone or in other multiple bearing sets. Back-to-back and face-to-face bearing sets can be preloaded to adjust bearing rigidity. Extra Light (EL), Light (L), Medium (M), and Heavy (H) are standard preloads. Friction torque of the bearing will increase in direct proportion to the preload.

The starting torque of angular contact ball bearings is mainly caused by angular slippage between the balls and contact surfaces on the inner and outer rings. Starting torque for the bearing M due to such spin is given by the following equation:

$$M = M_s Z \sin \alpha \quad (\text{mN}\cdot\text{m}), \{\text{kgf}\cdot\text{mm}\} \quad (10.2)$$

where M_s : Spin friction for contact angle α centered on the shaft,

$$M_s = \frac{3}{8} \mu_s \cdot Q \cdot a \cdot E(k) \quad (\text{mN}\cdot\text{m}), \{\text{kgf}\cdot\text{mm}\}$$

μ_s : Contact-surface slip friction coefficient
 Q : Load on rolling elements (N), {kgf}
 a : (1/2) of contact-ellipse major axis (mm)

$$E(k) : \text{With } k = \sqrt{1 - \left(\frac{b}{a}\right)^2}$$

as the population parameter, second class complete ellipsoidal integration

b : (1/2) of contact-ellipse minor axis (mm)
 Z : Number of balls
 α : Contact angle ($^\circ$)

Actual measurements with 15° angular contact ball bearings correlate well with calculated results using $\mu_s = 0.15$ in Equation (10.2). Fig. 10.1 shows the calculated friction torque for Series 70C and 72C bearings.

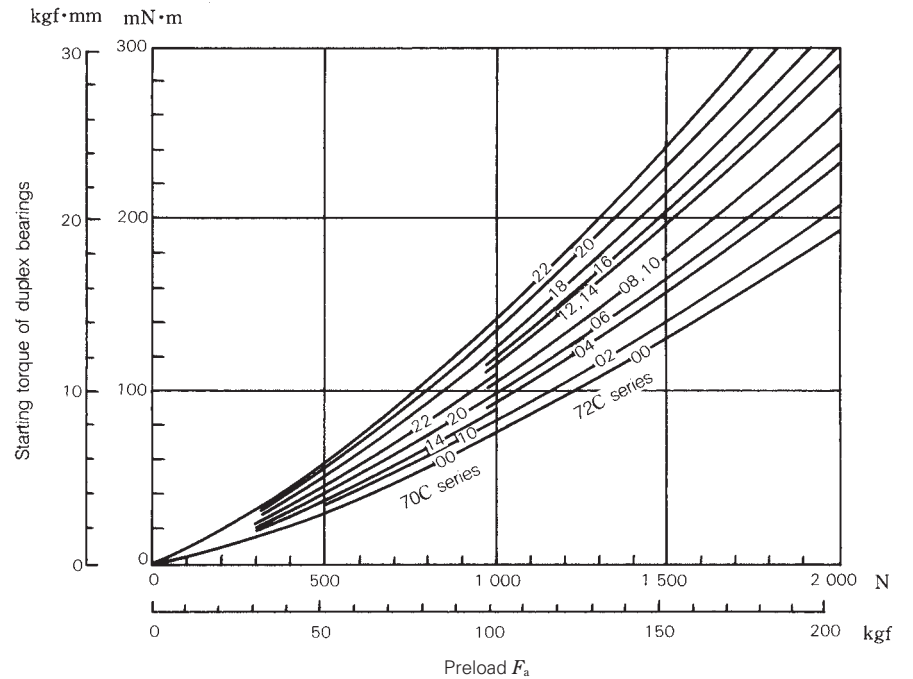

Fig. 10.1 Preload and Starting Torque for DF and DB Angular Contact Ball Bearing ($\alpha=15^\circ$) Arrangements

10.3.2 Empirical Equations for Running Torque of High-Speed Ball Bearings

Empirical equations are presented below for the running torque of high speed ball bearings subject to axial loading and jet lubrication. These equations are based on the results of tests of angular contact ball bearings with bore diameters of 10 to 30 mm, but they can be extrapolated to larger bearings.

Running torque M can be obtained as the sum of a load term M_l and speed term M_v , as follows:

$$M = M_l + M_v \text{ (mN} \cdot \text{m)}, \text{ {kgf} \cdot \text{mm}} \dots\dots\dots (10.3)$$

Load term M_l refers to friction with no relation to speed or fluid friction and is expressed by the experimentally-based Equation (10.4).

$$\left. \begin{aligned} M_l &= 0.672 \times 10^{-3} D_{pw}^{0.7} F_a^{1.2} \text{ (mN} \cdot \text{m)} \\ &= 1.06 \times 10^{-3} D_{pw}^{0.7} F_a^{1.2} \text{ {kgf} \cdot \text{mm}} \end{aligned} \right\} \dots\dots\dots (10.4)$$

where, D_{pw} : Pitch diameter of rolling elements (mm)
 F_a : Axial load (N), {kgf}

Speed term M_v refers to fluid friction, which depends on angular speed and is expressed by Equation (10.5).

$$\left. \begin{aligned} M_v &= 3.47 \times 10^{-10} D_{pw}^3 n_i^{1.4} Z_B^a Q^b \text{ (mN} \cdot \text{m)} \\ &= 3.54 \times 10^{-11} D_{pw}^3 n_i^{1.4} Z_B^a Q^b \text{ {kgf} \cdot \text{mm}} \end{aligned} \right\} \dots\dots\dots (10.5)$$

where, n_i : Inner ring speed (min^{-1})
 Z_B : Absolute viscosity of oil at outer ring temperature (mPa·s), {cp}
 Q : Oil flow rate (kg/min)

Exponents a and b, which affect oil viscosity and flow rate factors, depend only on angular speed and are given by Equations (10.6) and (10.7) as follows:

$$a = 24n_i^{-0.37} \dots\dots\dots (10.6)$$

$$b = 4 \times 10^{-9} n_i^{1.6} + 0.03 \dots\dots\dots (10.7)$$

An example estimation for the running torque of high-speed ball bearings is shown in Fig. 10.2. A comparison of values calculated using these equations and actual measurements is shown in Fig. 10.3. When the contact angle exceeds 30°, the influence of spin friction becomes large, so the running torque given by the equations will be low.

Calculation Example

Obtain the running torque of high speed angular contact ball bearing 20BNT02 ($\phi 20 \times \phi 47 \times 14$) under the following conditions:

$n_i = 70\,000 \text{ min}^{-1}$
 $F_a = 590 \text{ N}, \text{ {60 kgf}}$
 Lubrication: Jet, oil viscosity:
 10 mPa·s {10 cp}
 oil flow: 1.5 kg/min

From Equation (10.4),

$$\begin{aligned} M_l &= 0.672 \times 10^{-3} D_{pw}^{0.7} F_a^{1.2} \\ &= 0.672 \times 10^{-3} \times 33.5^{0.7} \times 590^{1.2} \\ &= 16.6 \text{ (mN} \cdot \text{m)} \\ M_l &= 1.06 \times 10^{-3} \times 33.5^{0.7} \times 60^{1.2} \\ &= 1.7 \text{ {kgf} \cdot \text{mm}} \end{aligned}$$

From Equations (10.6) and (10.7),

$$\begin{aligned} a &= 24n_i^{-0.37} \\ &= 24 \times 70\,000^{-0.37} = 0.39 \\ b &= 4 \times 10^{-9} n_i^{1.6} + 0.03 \\ &= 4 \times 10^{-9} \times 70\,000^{1.6} + 0.03 = 0.26 \end{aligned}$$

From Equation (10.5),

$$\begin{aligned} M_v &= 3.47 \times 10^{-10} D_{pw}^3 n_i^{1.4} Z_B^a Q^b \\ &= 3.47 \times 10^{-10} \times 33.5^3 \times 70\,000^{1.4} \times 10^{0.39} \times 1.5^{0.26} \\ &= 216 \text{ (mN} \cdot \text{m)} \end{aligned}$$

$$\begin{aligned} M_v &= 3.54 \times 10^{-11} \times 33.5^3 \times 70\,000^{1.4} \times 10^{0.39} \times 1.5^{0.26} \\ &= 22.0 \text{ {kgf} \cdot \text{mm}} \end{aligned}$$

$$\begin{aligned} M &= M_l + M_v = 16.6 + 216 = 232.6 \text{ (mN} \cdot \text{m)} \\ M &= M_l + M_v = 1.7 + 22 = 23.7 \text{ {kgf} \cdot \text{mm}} \end{aligned}$$

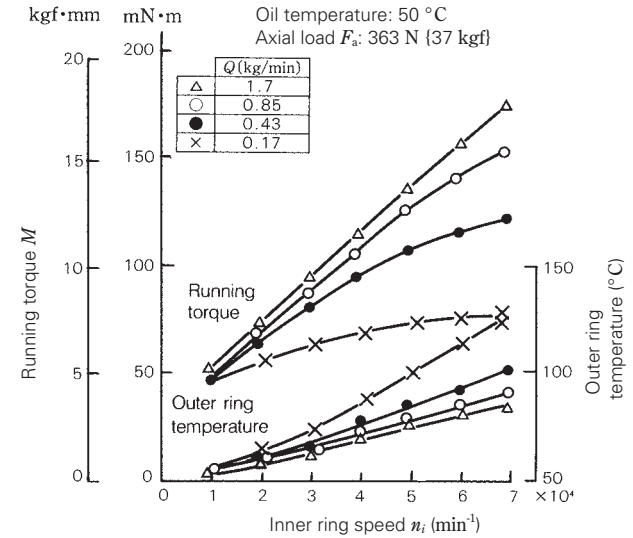

Fig. 10.2 Typical Test Example

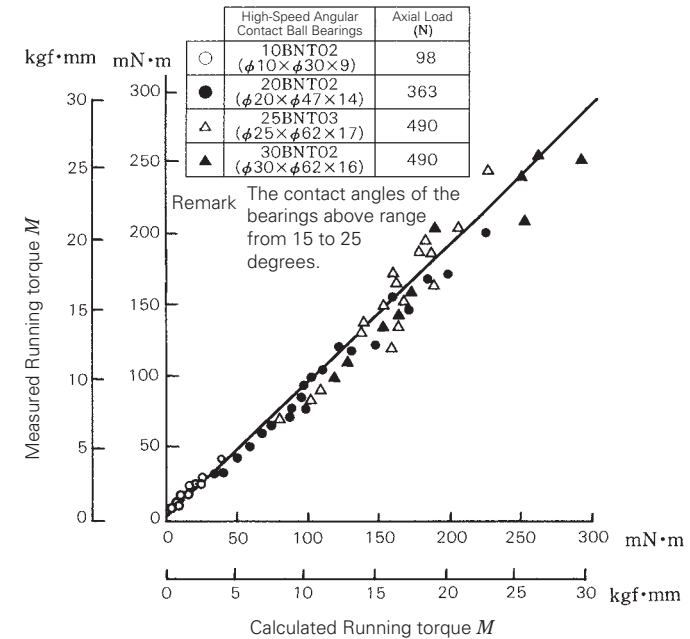

Fig. 10.3 Comparison of Actual Measurements and Calculated Values

10.3.3 Preload and Starting Torque for Tapered Roller Bearings

The balance of loads on the bearing rollers when a tapered roller bearing is subjected to axial load F_a is expressed by the following three Equations:

$$Q_e = \frac{F_a}{Z \sin \alpha} \quad (10.8)$$

$$Q_i = Q_e \cos 2\beta = \frac{\cos 2\beta}{Z \sin \alpha} F_a \quad (10.9)$$

$$Q_t = Q_e \sin 2\beta = \frac{\sin 2\beta}{Z \sin \alpha} F_a \quad (10.10)$$

- where Q_e : Rolling element load on outer ring (N), {kgf}
- Q_i : Rolling element load on inner ring (N), {kgf}
- Q_t : Rolling element load on inner ring large end rib, (N), {kgf} (assume $Q_t \perp Q_i$)
- Z : Number of rollers
- α : Contact angle...one-half included outer ring angle ($^\circ$)
- β : One-half the tapered roller angle ($^\circ$)
- D_{w1} : Roller large end diameter (mm) (Fig. 10.4)
- e : Contact point between roller end and rib (Fig. 10.4)

As represented in Fig. 10.4, when circumferential load F is applied to the bearing outer ring and the roller turns in the direction of the applied load, the starting torque for contact point C relative to instantaneous center A becomes $e \mu_c Q_t$.

Therefore, the balance of frictional torque is

$$D_{w1} F = e \mu_c Q_t \text{ (mN}\cdot\text{m), {kgf}\cdot\text{mm}} \quad (10.11)$$

where μ_c : Friction coefficient between inner ring large rib and roller end face

Starting torque M for one bearing is given by

$$M = F Z l$$

$$= \frac{e \mu_c l \sin 2\beta}{D_{w1} \sin \alpha} F_a$$

(mN·m), {kgf·mm} (10.12)

because $D_{w1} = 2 \overline{OB} \sin \beta$, and $l = \overline{OB} \sin \alpha$.
If we substitute these into Equation (10.12), we obtain

$$M = e \mu_c \cos \beta F_a \text{ (mN}\cdot\text{m), {kgf}\cdot\text{mm}} \quad (10.13)$$

Starting torque M is sought considering only the slip friction between the roller end and the inner ring large-end rib. However, when the load on a tapered roller bearing reaches or exceeds a certain level (around the preload), the slip friction in the space between the roller end and inner ring large end rib becomes the decisive factor for bearing starting torque, and the torque caused by other factors can be ignored. Values for e and β in Equation (10.12) are determined by bearing design. Consequently, by assuming a value for μ_c , the starting torque can be calculated.

The values for μ_c and for e must be considered as a dispersion; thus, even bearings with the same number can have quite diverse individual starting torques. When using a value for e determined by the bearing design, the average value for the bearing starting torque can be estimated using $\mu_c = 0.20$, which is the average value determined from various test results.

Fig. 10.5 shows the results of calculations for various tapered roller bearing series.

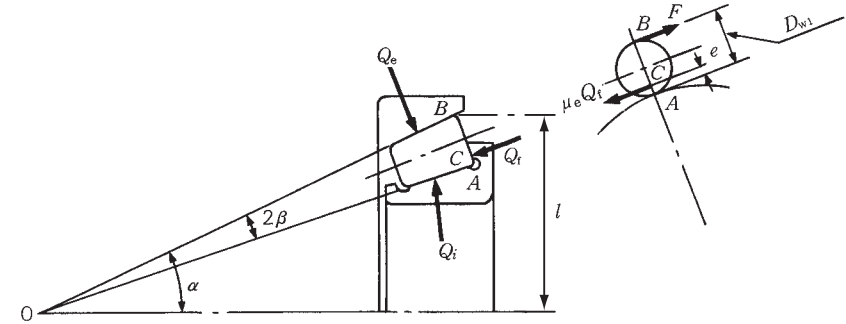

Fig. 10.4

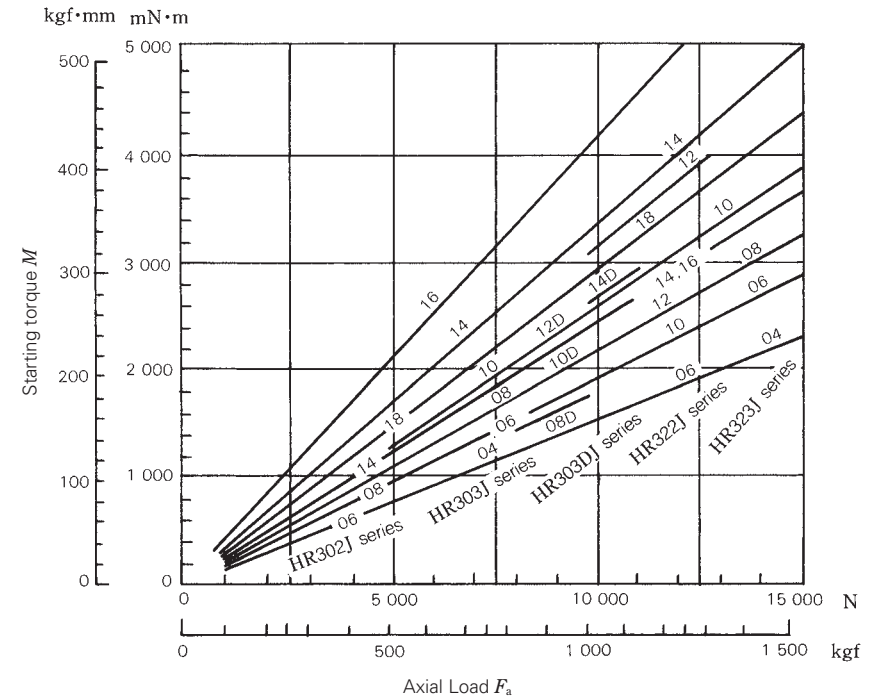

Fig. 10.5 Axial Load and Starting Torque for Tapered Roller Bearings

10.3.4 Empirical Equations for Running Torque of Tapered Roller Bearings

When tapered roller bearings operate under axial load, the torque of tapered roller bearings is based on the following two kinds of resistance, which are the major components of friction:

- (1) Rolling resistance (friction) of rollers with outer or inner ring raceways—elastic hysteresis and viscous rolling resistance of EHL
- (2) Sliding friction between inner ring ribs and roller ends.

When an axial load F_a is applied on tapered roller bearings, the loads shown in Fig. 10.6 are applied on the rollers.

$$Q_e \doteq Q_i = \frac{F_a}{Z \sin \alpha} \dots\dots\dots (10.14)$$

$$Q_i = \frac{F_a \sin 2\beta}{Z \sin \alpha} \dots\dots\dots (10.15)$$

- where
- Q_e : Rolling element load on outer ring
 - Q_i : Rolling element load on inner ring
 - Q_i : Rolling element load on inner ring large end rib
 - Z : Number of rollers
 - α : Contact angle...One-half included outer ring angle
 - β : One-half tapered roller angle

For simplicity, Fig. 10.7 shows a model using the average diameter D_w along with the following variables:

- M_i, M_e : Rolling resistance (moment)
- F_{si}, F_{se}, F_{st} : Sliding friction
- R_i, R_e : Radii at center of inner and outer ring raceways
- e : Contact height of roller end face with rib

When the balance of sliding friction and moments on the rollers is considered as represented in Fig 10.7, the following equations are obtained:

$$F_{se} - F_{st} = F_{st} \dots\dots\dots (10.16)$$

$$M_i + M_e = \frac{D_w}{2} F_{se} + \frac{D_w}{2} F_{st} + \left(\frac{D_w}{2} - e \right) F_{st} \dots\dots\dots (10.17)$$

When the running torque M applied on the outer (inner) ring is calculated using Equations (10.16) and (10.17) and multiplied by the number of rollers Z , the following is obtained:

$$\begin{aligned} M &= Z (R_e F_{se} - M_e) \\ &= \frac{Z}{D_w} (R_e M_i + R_i M_e) + \frac{Z}{D_w} R_e e F_{st} \\ &= M_R + M_S \end{aligned}$$

Therefore, the rolling friction on the raceway surface M_R and sliding friction on the ribs M_S are separately obtained.

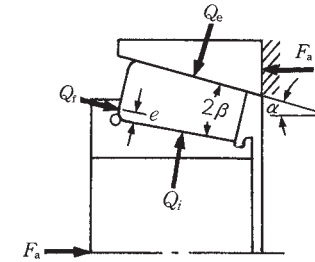

Fig. 10.6 Loads Applied on Roller

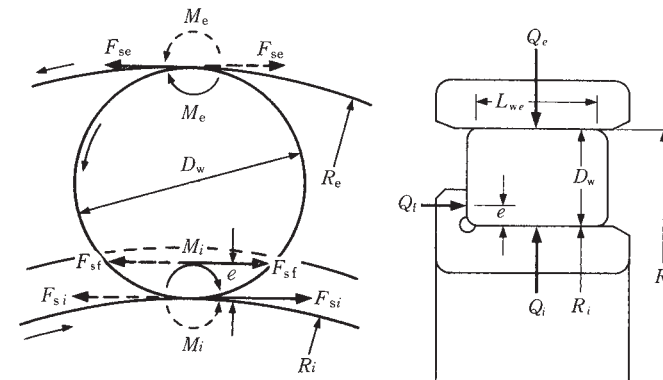

Fig. 10.7 Parts Where Friction is Generated

The running torque M of a tapered roller bearing can be obtained from the rolling friction on the raceway M_R and sliding friction on the ribs M_S .

$$M = M_R + M_S = \frac{Z}{D_w} (R_c M_i + R_i M_e) + \frac{Z}{D_w} R_c e F_{sf} \dots \dots \dots (10.18)$$

Sliding Friction on Rib M_S

As a part of M_S , F_{sf} refers to the tangential load caused by sliding, so we can write $F_{sf} = \mu Q_t$ using the coefficient of dynamic friction μ . Further, by substituting in axial load F_a , the following equation is obtained:

$$M_S = e \mu \cos \beta F_a \dots \dots \dots (10.19)$$

This is identical to the equation for starting torque, but μ is not constant and decreases depending on operating conditions and running-in. For this reason, Equation (10.19) can be rewritten as follows:

$$M_S = e \mu_0 \cos \beta F_a f' (A, t, \sigma) \dots \dots \dots (10.20)$$

where μ_0 is approximately 0.2 and $f' (A, t, \sigma)$ is a function that decreases with running in and oil film formation but is set equal to one at starting.

Rolling Friction on Raceway Surface M_R

Most of the rolling friction on the raceway is from viscous oil resistance (EHL rolling resistance) corresponding to M_i and M_e in Equation (10.18). A theoretical equation exists but should be corrected based on the results of experiments. The following equation includes corrective terms:

$$M_{i, e} = \left[f(w) \left(\frac{1}{1 + 0.29L^{0.78}} \right) \frac{4.318}{\alpha_0} (G \cdot U)^{0.658} W^{0.0126} R^2 L_{we} \right]_{i, e} \dots \dots \dots (10.21)$$

$$f(w) = \left(\frac{k F_a}{E' D_w L_{we} Z \sin \alpha} \right)^{0.3} \dots \dots \dots (10.22)$$

Therefore, M_R can be obtained using Equations (10.21) and (10.22) together with the following equation:

$$M_R = \frac{Z}{D_w} (R_c M_i + R_i M_e)$$

Running Torque of Bearings M

From these, the running torque of tapered roller bearings M is given by Equation (10.23).

$$M = \frac{Z}{D_w} (R_c M_i + R_i M_e) + e \mu_0 \cos \beta F_a f' (A, t, \sigma) \dots \dots \dots (10.23)$$

As shown in Figs. 10.8 and 10.9, the values obtained using Equation (10.23) correlate rather well with actual measurements; therefore, estimation of running torque with good accuracy is possible. Please consult NSK with any questions or concerns.

[Symbol Definitions]

- G, W, U : EHL dimensionless parameters
- L : Coefficient of thermal load
- α_0 : Pressure coefficient of lubricating oil viscosity
- R : Equivalent radius
- k : Constant
- E' : Equivalent elastic modulus
- α : Contact angle (One-half included outer ring angle)
- R_i, R_c : Inner and outer ring raceway radii (center)
- β : Half angle of roller
- i, e : Indication of inner ring or outer ring respectively
- L_{we} : Effective roller length

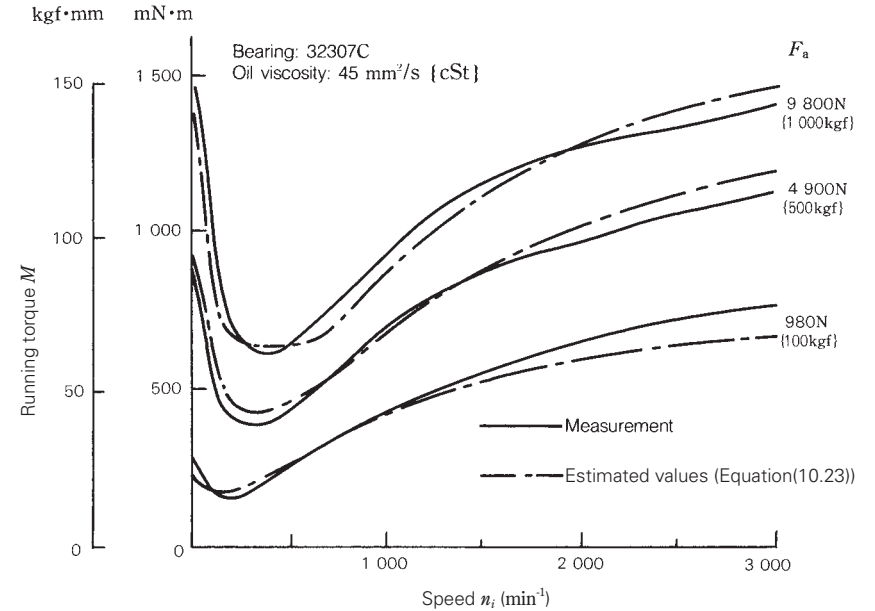

Fig. 10.8 Comparison of Estimated Values With Actual Measurements

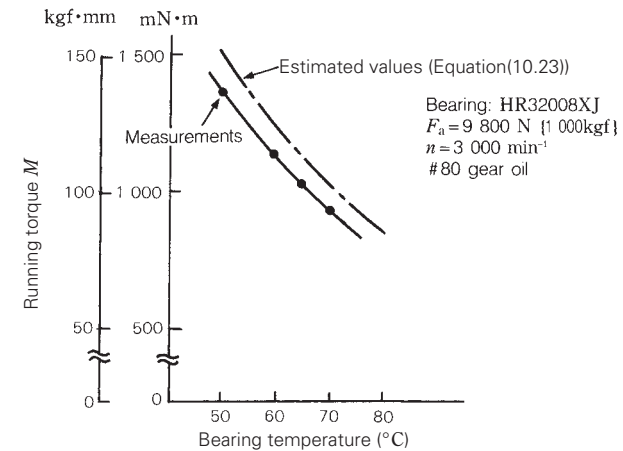

Fig. 10.9 Viscosity Variation and Running Torque

11. LUBRICATION

11.1	Purposes of Lubrication	A 228
11.2	Lubricating Methods	A 228
11.2.1	Grease Lubrication	A 228
(1)	Grease Quantity	A 228
(2)	Replacement of Grease	A 229
(3)	Replenishment Interval	A 229
(4)	Grease Life of Sealed Ball Bearings	A 231
11.2.2	Oil Lubrication	A 232
(1)	Oil Bath Lubrication	A 232
(2)	Drip-Feed Lubrication	A 232
(3)	Splash Lubrication	A 232
(4)	Circulating Lubrication	A 233
(5)	Jet Lubrication	A 234
(6)	Oil Mist Lubrication	A 235
(7)	Oil/Air Lubricating Method	A 235
11.3	Lubricants	A 236
11.3.1	Lubricating Grease	A 236
(1)	Base Oil	A 236
(2)	Thickener	A 236
(3)	Additives	A 236
(4)	Consistency	A 236
(5)	Mixing Different Types of Grease	A 238
11.3.2	Lubricating Oil	A 238
11.4	Technical Data	A 240
11.4.1	Brands and Properties of Lubricating Greases	A 240



11. LUBRICATION

11.1 Purposes of Lubrication

The main purposes of lubrication are to reduce friction and wear inside the bearings that may cause premature failure. The effects of lubrication may be briefly explained as follows:

(1) Reduction of Friction and Wear

Direct metallic contact between the basic components of the bearing (bearing rings, rolling elements and cage) is prevented by an oil film that reduces friction and wear in contact areas.

(2) Extension of Fatigue Life

The rolling fatigue life of bearings depends greatly upon the viscosity and film thickness between the rolling contact surfaces. A heavy film thickness prolongs fatigue life, but life is shortened if the viscosity of the oil is so low that film thickness is insufficient.

(3) Dissipation of Frictional Heat and Cooling

Circulation lubrication is used to carry away frictional or absorbed heat, prevent the bearing from overheating, and prevent oil from deteriorating.

(4) Others

Adequate lubrication also helps to prevent foreign material from entering the bearings and guards against corrosion and rusting.

11.2 Lubricating Methods

Lubricating methods are first divided into either grease or oil lubrication. Satisfactory bearing performance can be achieved by adopting the lubricating method most suitable for the particular application and operating condition.

In general, oil offers superior lubrication; however, grease lubrication allows for a simpler structure around the bearings. A comparison of grease and oil lubrication is given in Table 11.1.

Table 11. 1 Comparison of Grease and Oil Lubrication

Item	Grease Lubrication	Oil Lubrication
Housing Structure and Sealing Method	Simple	May be complex. Careful maintenance required
Speed	Limiting speed 65% to 80% that of oil lubrication.	Higher limiting speed
Cooling Effect	Poor	Heat transfer possible using forced oil circulation.
Fluidity	Poor	Good
Full Lubricant Replacement	Sometimes difficult	Compactively easy
Removal of Foreign Matter	Removal of particles from grease is impossible.	Easy
External Contamination Due to Leakage	Surroundings seldom contaminated by leakage.	Often leaks without proper countermeasures. Not suitable if external contamination must be avoided.

11.2.1 Grease Lubrication

(1) Grease Quantity

The quantity of grease to be packed in a housing depends on the housing design and free space, grease characteristics, and ambient temperature. For example, bearings for main shafts of machine tools where the accuracy may be impaired by a small temperature rise require only a small amount of grease.

Sufficient grease must be packed inside the bearing including the cage guide face. The amount to be packed inside the the housing depends on the speed of the application:

When bearing speed is 50% or less of the specified limiting speed, fill 1/2 to 2/3 of the free space.

When bearing speed is 50% or more of the specified limiting speed, fill 1/3 to 1/2 of the free space.

(2) Replacement of Grease

Grease, once packed, usually need not be replenished for a long time; however, under severe operating conditions, grease should be frequently replenished or replaced. In such cases, the bearing housing should be designed to facilitate grease replenishment and replacement.

When replenishment intervals are short, provide replenishment and discharge ports at appropriate positions so that deteriorated grease is replaced by fresh grease. For example, the housing space on the grease-supply side can be divided into several sections with partitions. The grease on the partitioned side gradually passes through the bearings and old grease forced from the bearing is discharged through a grease valve (Fig. 11.1). If a grease valve is not used, the

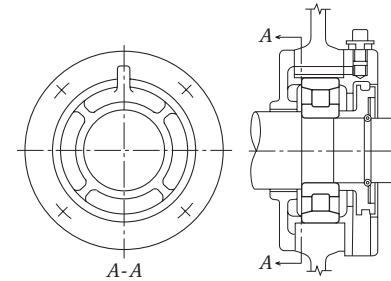

Fig. 11.1 Combination of Partitioned Grease Reservoir and Grease Valve

space on the discharge side must be larger than the partitioned side so that it can retain old grease, which can be removed periodically by removing the cover.

(3) Replenishment Interval

Even if high-quality grease is used, grease deterioration occurs with time; therefore, periodic replenishment is required. Graphs (1) and (2) in Fig 11.2 show the replenishment time intervals for various bearing types running at different speeds. These graphs show high-quality, lithium-soap mineral oil grease at a bearing temperature of 70 °C under normal load ($P/C=0.1$).

· Temperature

If the bearing temperature exceeds 70 °C, reduce the replenishment interval by half for every 15 °C increase.

· Grease

Replenishment intervals can be extended depending on used grease type, especially for ball bearings. For example, high-quality lithium-soap synthetic oil grease may roughly doubles the replenishment interval shown in Fig.11.2 (1). If the temperature of the bearings is less than 70 °C, the usage of lithium-soap mineral oil grease or lithium-soap synthetic oil grease is appropriate.

Please consult NSK for details.

· Load

The replenishment interval depends on the magnitude of the bearing load.

Please refer to Fig.11.2 (3) for details.

If P/C exceeds 0.16, please consult NSK.

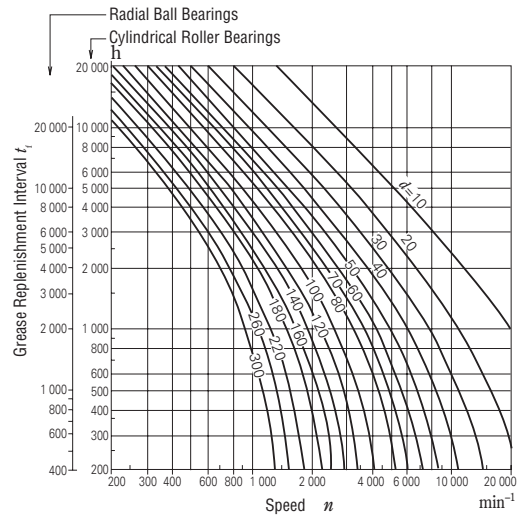

(1) Radial Ball Bearings, Cylindrical Roller Bearings

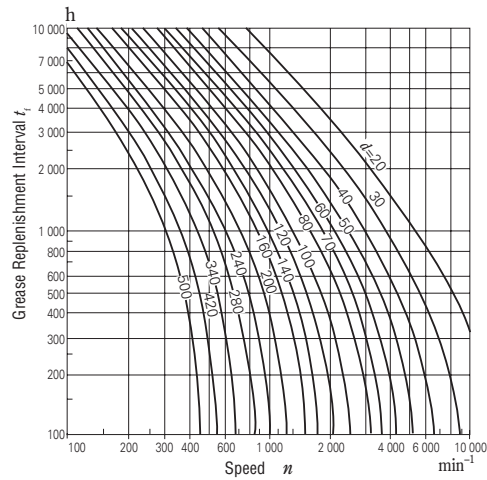

(2) Tapered Roller Bearings, Spherical Roller Bearings

(3) Load factor

P/C	≤0.06	0.1	0.13	0.16
Load factor	1.5	1	0.65	0.45

Fig. 11.2 Grease Replenishment Intervals

(4) Grease Life of Sealed Ball Bearings

When grease is packed into single-row deep groove ball bearings, the grease life may be estimated using Equation (11.1), Equation (11.2), or Fig. 11.3: (General purpose grease ⁽¹⁾)

$$\log t = 6.54 - 2.6 \frac{n}{N_{\max}} - \left(0.025 - 0.012 \frac{n}{N_{\max}}\right) T \dots \dots \dots (11.1)$$

(Wide-range grease ⁽²⁾)

$$\log t = 6.12 - 1.4 \frac{n}{N_{\max}} - \left(0.018 - 0.006 \frac{n}{N_{\max}}\right) T \dots \dots \dots (11.2)$$

where *t* : Average grease life (h)
n : Speed (min⁻¹)
*N*_{max} : Limiting speed with grease lubrication (min⁻¹)
 (values for ZZ and VV types are listed in the bearing tables)
T : Operating temperature °C

Equation (11.1), Equation (11.2), and Fig. 11.3 apply under the following conditions:

(a) Speed *n*

$$0.25 \leq \frac{n}{N_{\max}} \leq 1$$

when $\frac{n}{N_{\max}} < 0.25$, assume $\frac{n}{N_{\max}} = 0.25$

(b) Operating Temperature *T*
 For general-purpose grease ⁽¹⁾ $70\text{ }^{\circ}\text{C} \leq T \leq 110\text{ }^{\circ}\text{C}$

For wide-range grease ⁽²⁾ $70\text{ }^{\circ}\text{C} \leq T \leq 130\text{ }^{\circ}\text{C}$

When *T* < 70 °C assume *T* = 70 °C

(c) Bearing Loads
 The bearing loads should be about 1/10 or less the basic load rating *C*_r.

Notes ⁽¹⁾ Mineral-oil base greases (e.g. lithium-soap base grease) often used around -10 to 110 °C.
⁽²⁾ Synthetic-oil base greases are usable over a wide temperature range around -40 to 130 °C.

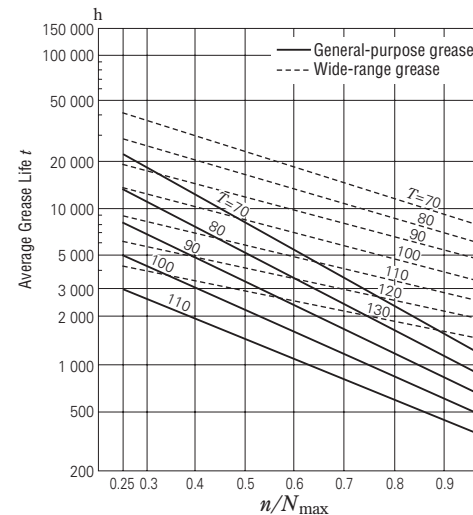

Fig. 11.3 Grease Life of Sealed Ball Bearings

11.2.2 Oil Lubrication

(1) Oil-Bath Lubrication

Oil-bath lubrication is widely used with low or medium speeds. The oil level should be at the center of the lowest rolling element. Ideally, provide a sight gauge so the proper oil level may be maintained (Fig. 11.4)

(2) Drip-Feed Lubrication

Drip-feed lubrication is widely used for small ball bearings operated at relatively high speeds. As shown in Fig. 11.5, oil is stored in a visible oiler. The oil drip rate is controlled with a screw in the top.

(3) Splash Lubrication

With this method, oil is splashed onto the bearings by gears or a simple rotating disc installed near bearings without submerging the bearings in oil. It is commonly used in automobile transmissions and final drive gears. Fig. 11.6 shows this lubricating method used on a reduction gear.

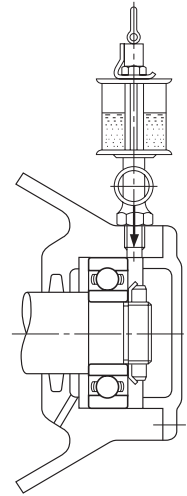

Fig. 11.5 Drip-Feed Lubrication

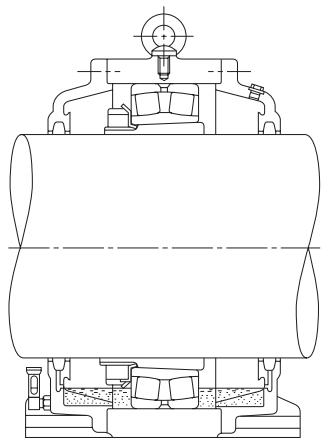

Fig. 11.4 Oil-Bath Lubrication

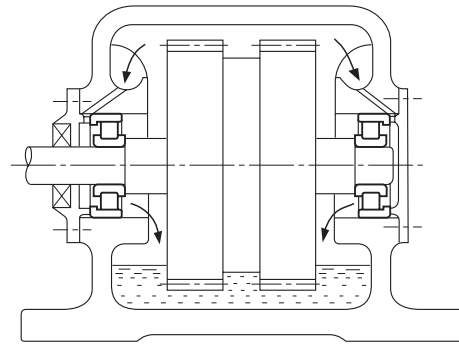

Fig. 11.6 Splash Lubrication

(4) Circulating Lubrication

Circulating lubrication is commonly used for high-speed operation requiring bearing cooling and for bearings used at high temperatures. As shown in Fig. 11.7 (a), oil is supplied by a pipe on the right side. The oil travels through the bearing and drains out through a pipe on the left. After being cooled in a reservoir, the oil returns to the bearing through a pump and filter. The oil discharge pipe should be larger than the supply pipe so that excessive oil does not back up in the housing.

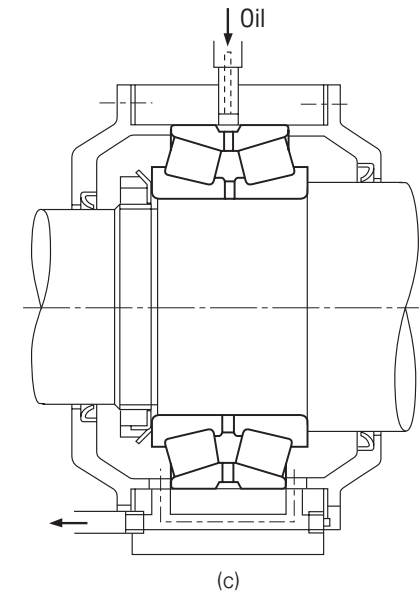
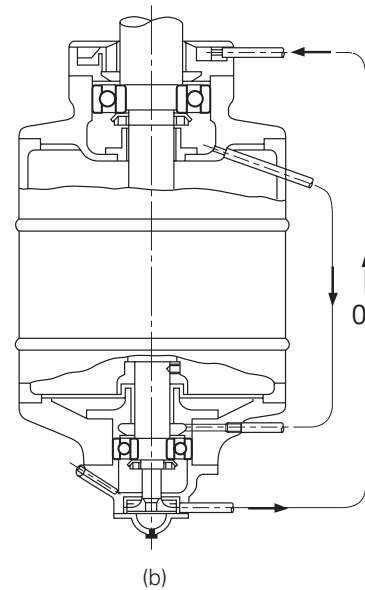
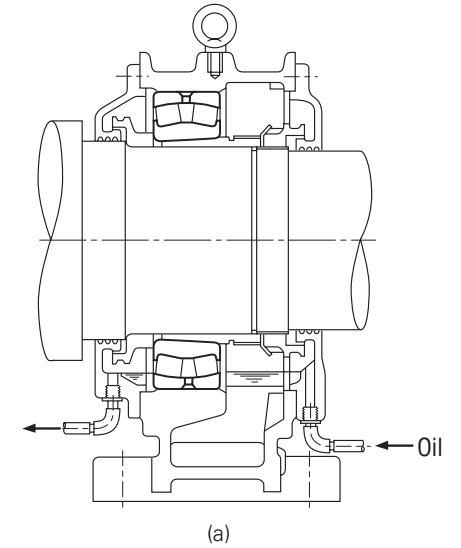

Fig. 11.7 Circulating Lubrication

(5) Jet Lubrication

Jet lubrication is often used for ultra-high-speed bearings with a $d_m n$ value (d_m : pitch diameter of rolling element set in mm; n : rotational speed in min^{-1}) exceeding one million, such as the bearings in jet engines. Lubricating oil is sprayed under pressure from one or more nozzles directly into the bearing.

Fig. 11.8 shows an example of ordinary jet lubrication. The lubricating oil is sprayed on the inner ring and cage guide face. In high-speed operation, the air surrounding the bearing rotates with it, causing the oil jet to be deflected. The jetting speed of the oil from the nozzle should be more than 20% of the circumferential speed of the inner ring outer surface, or cage guide face.

More uniform cooling and a better temperature distribution is achieved using more nozzles for a given amount of oil. The oil should be forcibly discharged so that the agitating resistance of the lubricant can be reduced and the oil can effectively carry away the heat.

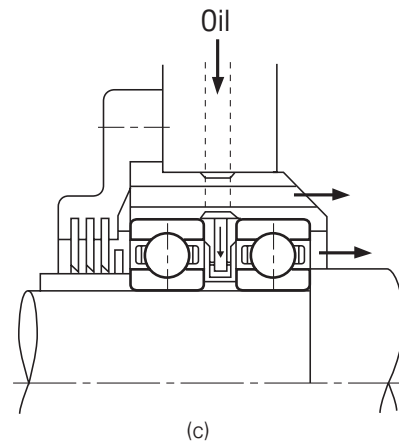
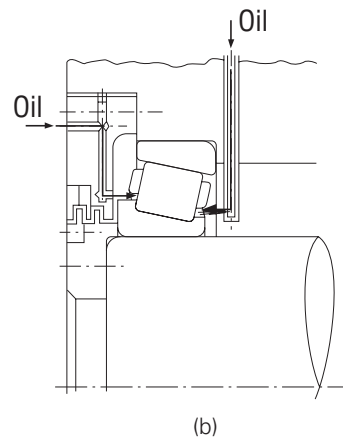
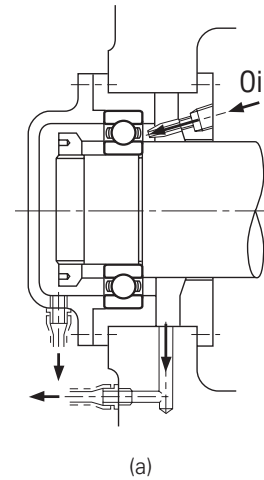

Fig. 11.8 Jet Lubrication

(6) Oil-Mist Lubrication

Oil-mist lubrication, or oil fog lubrication, utilizes an oil mist sprayed into a bearing. This method has the following advantages:

(a) Because of the small quantity of oil required, the oil agitation resistance is small, and higher speeds are possible.

(b) Contamination of the vicinity around the bearing is limited because the oil leakage is small.

(c) It is relatively easy to continuously supply fresh oil; therefore, bearing life is extended.

This lubricating method is used for bearings in the high-speed spindles of machine tools, high-speed pumps, roll necks of rolling mills, and so on (see example in Fig. 11.9).

Please consult NSK regarding oil-mist lubrication of large bearings.

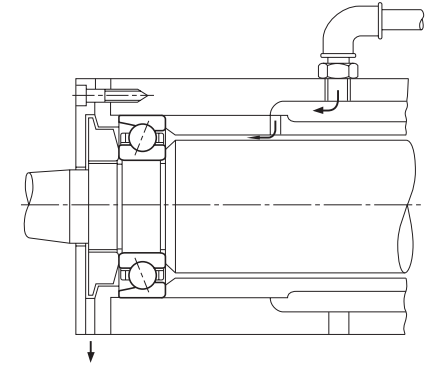

Fig. 11.9 Oil-Mist Lubrication

(7) Oil-Air Lubricating Method

With the oil-air lubricating method, a very small amount of oil is discharged intermittently by a constant-quantity piston into a pipe carrying a constant flow of compressed air. The oil flows along the wall of the pipe and approaches a constant flow rate.

The major advantages of oil-air lubrication are as follows: (a) The minimum necessary amount of oil is supplied, making this method suitable for high speeds because less heat is generated.

(b) Since oil is fed continuously, bearing temperature remains stable. Also, because of the small amount of oil, there is almost no atmospheric pollution.

(c) Only fresh oil is fed to the bearings, so oil deterioration need not be considered.

(d) Compressed air is constantly fed to the bearings and keeps internal pressure high. This prevents the entry of dust, cutting fluid, etc.

For these reasons, this method is used in the main spindles of machine tools and other high speed-applications (see example in Fig. 11.10).

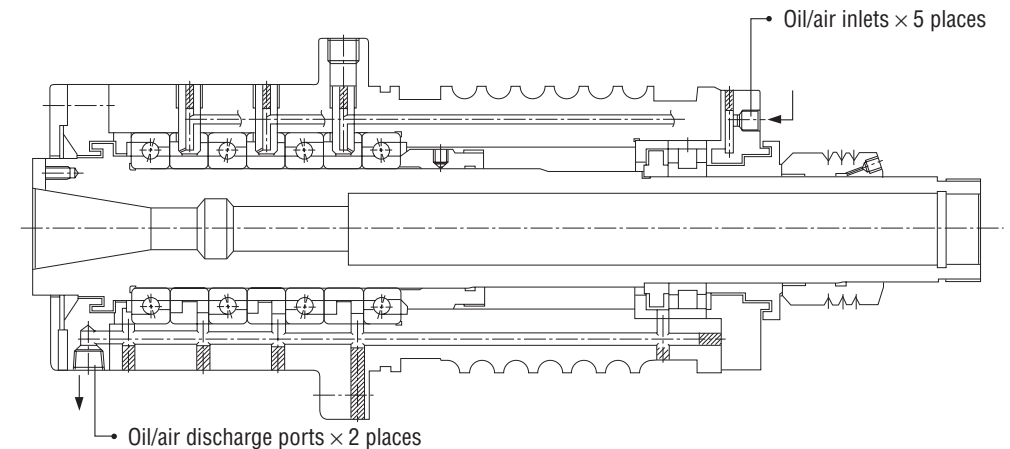

Fig. 11.10 Oil-Air Lubrication

11.3 Lubricants

11.3.1 Lubricating Grease

Grease is a semisolid lubricant consisting of base oil, a thickener, and additives. The main types and general properties of grease are shown in Table 11.2. Note that different brands of the same type of grease may have different properties.

(1) Base Oil

Mineral oils or synthetic oils, such as silicone or diester oil, are often used as the base oil for grease. The lubricating properties of grease depend mainly on the characteristics of its base oil. Therefore, the viscosity of the base oil is just as important when selecting grease as when selecting an oil. Usually, grease made with low viscosity base oils is more suitable for high speeds and low temperatures, while grease made with high viscosity base oils is more suited for high temperatures and heavy loads. However, the thickener also influences the lubricating properties of grease; therefore, the selection criteria for grease is not the same as for lubricating oil. Moreover, please be aware that ester-based grease will cause acrylic rubber material to swell, and that silicone-based grease will cause silicone-based material to swell.

(2) Thickener

Thickeners for lubricating grease include several types of metallic soaps, inorganic thickeners such as silica gel and bentonite, and heat resisting organic thickeners such as polyurea and fluoric compounds. The type of thickener is closely related to the grease dropping point ⁽¹⁾; generally, grease with a high dropping point also has a high temperature capability during operation. However, this type of grease does not have a high working temperature unless the base oil is heat-resistant. The highest possible working temperature for grease should be determined considering the heat resistance of the base oil. The water resistance of grease depends upon the type of thickener. Sodium-soap grease or compound grease containing sodium soap emulsifies when exposed to water or high humidity and therefore cannot be used where moisture is prevalent. Moreover, note that urea-based grease will cause fluorine-based material to deteriorate.

Note ⁽¹⁾ The grease dropping point is that temperature at which a grease heated in a specified small container becomes sufficiently fluid to drip.

Table 11.2 Grease Properties

Name (Popular Name)	Lithium Grease			Sodium Grease (Fiber Grease)	Calcium Grease (Cup Grease)	Mixed Base Grease	Complex Base Grease (Complex Grease)	Non-Soap Base Grease (Non-Soap Grease)	
	Thickener			Na Soap	Ca Soap	Na + Ca Soap, Li + Ca Soap, etc.	Ca Complex Soap, Al Complex Soap, Li Complex Soap, etc.	Urea, Bentonite, Carbon Black, Fluoric Compounds, Heat Resistant Organic Compound, etc.	
Properties	Base Oil			Mineral Oil	Mineral Oil	Mineral Oil	Mineral Oil	Mineral Oil	Synthetic Oil (Ester Oil, Polyatomic Ester Oil, Synthetic Hydrocarbon Oil, Silicone Oil, Fluoric Base Oil)
	Mineral Oil	Diester Oil, Polyatomic Ester Oil	Silicone Oil						
Dropping Point, °C	170 to 195	170 to 195	200 to 210	170 to 210	70 to 90	160 to 190	180 to 300	> 230	> 230
Working Temperatures, °C	-20 to +110	-50 to +130	-50 to +160	-20 to +130	-20 to +60	-20 to +80	-20 to +130	-10 to +130	< +220
Working Speed, % ⁽¹⁾	70	100	60	70	40	70	70	70	40 to 100
Mechanical Stability	Good	Good	Good	Good	Poor	Good	Good	Good	Good
Pressure Resistance	Fair	Fair	Poor	Fair	Poor	Fair to Good	Fair to Good	Fair	Fair
Water Resistance	Good	Good	Good	Poor	Good	Poor for Na Soap Grease	Good	Good	Good
Rust Prevention	Good	Good	Poor	Poor to Good	Good	Fair to Good	Fair to Good	Fair to Good	Fair to Good
Remarks	General-purpose grease used for numerous applications	Good low-temperature and torque characteristics. Often used for small motors and instrument bearings. Monitor for rust caused by insulation varnish.	Mainly used for high temperature applications. Unsuitable for bearings at high and low speeds, under heavy loads, or with numerous sliding-contact areas (roller bearings, etc.)	Long-and-short-fiber types are available. Long-fiber grease is unsuitable for high speeds. Monitor for water and high temperatures.	Extreme-pressure grease containing high viscosity mineral oil and extreme pressure additives (Pb soap, etc.) with high pressure resistance.	Often used for roller bearings and large ball bearings.	Suitable for extreme pressures mechanically stable	Mineral oil base grease is used for medium to high temperatures. Synthetic-oil base grease is recommended for low or high temperatures. Some silicone and fluoric oil base grease have poor rust prevention and noise characteristics.	

Note ⁽¹⁾ The values listed are percentages of the limiting speeds given in the bearing tables.

Remark The grease properties shown here can vary between brands.

(3) Additives

Grease often contains various additives such as antioxidants, corrosion inhibitors, and extreme pressure additives to give it special properties. Extreme pressure additives are recommended for heavy load applications. For long use without replenishment, an antioxidant should be added.

(4) Consistency

Consistency indicates the "softness" of grease. Table 11.3 shows the relation between consistency and operating conditions.

Table 11.3 Consistency and Working Conditions

Consistency Number	0	1	2	3	4
Consistency ⁽¹⁾ 1/10 mm	355 to 385	310 to 340	265 to 295	220 to 250	175 to 205
Working Conditions (Application)	-For centralized oiling -When fretting is likely to occur	-For centralized oiling -When fretting is likely to occur -For low temperatures	-For general use -For sealed ball bearings	-For general use -For sealed ball bearings -For high temperatures	-For high temperatures -For grease seals

Note ⁽¹⁾ Consistency: The depth to which a cone descends into grease when a specified weight is applied, indicated in units of 1/10 mm. The larger the value, the softer the grease.

(5) Mixing Different Types of Grease

In general, different brands of grease must not be mixed. Mixing grease with different types of thickeners may destroy its composition and physical properties. Even if thickeners are of the same type, possible differences in the additive may cause detrimental effects.

11.3.2 Lubricating Oil

The lubricating oils used for rolling bearings are usually highly refined mineral oils or synthetic oils that have a high oil-film strength and superior oxidation and corrosion resistance. When selecting a lubricating oil, the viscosity during operation is important. If the viscosity is too low, a proper oil film does not form and abnormal wear and seizure may occur. On the other hand, if the viscosity is too high, excessive viscous resistance may cause heating or energy loss. In general, low viscosity oils should be used at high speed; however, the viscosity should increase with

increasing bearing load and size. Table 11.4 gives generally recommended viscosities for bearings under normal operating conditions. Fig. 11.11 shows the relationship between oil temperature and viscosity, and selected lubricating oils are shown in Table 11.5.

Table 11.4 Bearing Types and Proper Viscosity of Lubricating Oils

Bearing Type	Proper Viscosity at Operating Temperature
Ball Bearings and Cylindrical Roller Bearings	Higher than 13mm ² /s
Tapered Roller Bearings and Spherical Roller Bearings	Higher than 20mm ² /s
Spherical Thrust Roller Bearings	Higher than 32mm ² /s

Remark 1mm²/s=1cSt (centistokes)

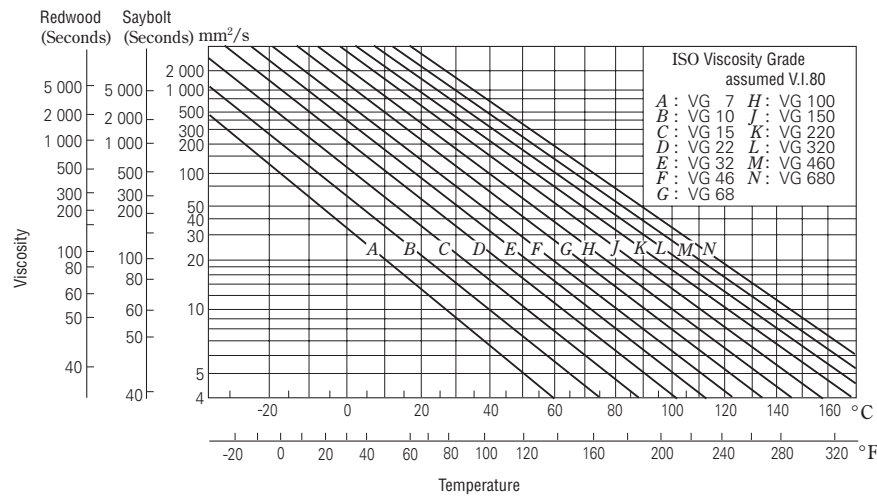

Fig. 11.11 Temperature-Viscosity Chart

Oil Replacement Intervals

Oil replacement intervals depend on operating conditions and oil quantity. In cases where the operating temperature is less than 50 °C and environmental conditions are good with little dust, the oil should be replaced approximately once a year. However, in cases where the oil temperature is near 100 °C, the oil must be changed at least once every three months.

If moisture may enter or if foreign matter may be mixed in the oil, then the oil replacement interval must be shortened. Do not mix different brands of oil as, like grease, their composition and physical properties may be negatively affected.

Table 11.5 Examples of Selection Lubricating Oils

Operating Temperature	Speed	Light or Normal Load	Heavy or Shock Load
-30 to 0 °C	Less than limiting speed	ISO VG 15, 22, 32 (refrigerating machine oil)	—
0 to 50 °C	Less than 50% of limiting speed	ISO VG 32, 46, 68 (bearing oil, turbine oil)	ISO VG 46, 68, 100 (bearing oil, turbine oil)
	50 to 100% of limiting speed	ISO VG 15, 22, 32 (bearing oil, turbine oil)	ISO VG 22, 32, 46 (bearing oil, turbine oil)
	More than limiting speed	ISO VG 10, 15, 22 (bearing oil)	—
50 to 80 °C	Less than 50% of limiting speed	ISO VG 100, 150, 220 (bearings oil)	ISO VG 150, 220, 320 (bearing oil)
	50 to 100% of limiting speed	ISO VG 46, 68, 100 (bearing oil, turbine oil)	ISO VG 68, 100, 150 (bearing oil, turbine oil)
	More than limiting speed	ISO VG 32, 46, 68 (bearing oil, turbine oil)	—
80 to 110 °C	Less than 50% of limiting speed	ISO VG 320, 460 (bearing oil)	ISO VG 460, 680 (bearing oil, gear oil)
	50 to 100% of limiting speed	ISO VG 150, 220 (bearing oil)	ISO VG 220, 320 (bearing oil)
	More than limiting speed	ISO VG 68, 100 (bearing oil, turbine oil)	—

- Remarks**
1. Use the values listed in the bearing tables for limiting speeds.
 2. Refer to Refrigerating Machine Oils (JIS K 2211), Bearing Oils (JIS K 2239), Turbine Oils (JIS K 2213), and Gear Oils (JIS K 2219) for more information.
 3. If the operating temperature is near the high end of the temperature range listed in the left column, select a high-viscosity oil.
 4. If the operating temperature is lower than -30 °C or higher than 110 °C, please consult NSK.

11.4 Technical Data

11.4.1 Brands and Properties of Lubricating Grease

Table 11.6 Brands of Lubricating Grease

Brand	Thickener	Base Oil(s)	Dropping Point (°C)	Consistency	Working Temperature Range ⁽¹⁾ (°C)	Pressure Resistance	Usable Limit Compared to Listed Limiting Speed (Grease) ⁽²⁾ (%)
EA3 GREASE	Urea ⁽³⁾	Poly- α -olefin oil	≥ 260	230	-40 to +150	Fair	100
EA5 GREASE	Urea ⁽³⁾	Poly- α -olefin oil	≥ 260	251	-40 to +160	Good	60
EA6 GREASE	Urea ⁽³⁾	Poly- α -olefin oil	≥ 260	220	-40 to +160	Fair	70
EA7 GREASE	Urea ⁽³⁾	Poly- α -olefin oil	≥ 260	243	-40 to +160	Fair	100
EA9 GREASE	Urea ⁽³⁾	Poly- α -olefin oil	≥ 260	314	-40 to +140	Fair	100
ENS GREASE	Urea ⁽³⁾	Polyol ester oil ⁽⁴⁾	≥ 260	264	-40 to +160	Poor	100
ECE GREASE	Lithium	Poly- α -olefin oil	≥ 260	235	-10 to +120	Poor	100
DOW CORNING(R) SH 44 M GREASE	Lithium	Silicone oil ⁽⁵⁾	210	260	-30 to +130	Poor	60
NS HI-LUBE	Lithium	Ester oil + Diester oil ⁽⁴⁾	192	250	-40 to +130	Poor	100
LG2 GREASE	Lithium	Poly- α -olefin oil + Mineral oil	201	199	-20 to +70	Poor	100
LGU GREASE	Urea ⁽³⁾	Poly- α -olefin oil	≥ 260	201	-40 to +120	Fair	70
EMALUBE 8030	Urea ⁽³⁾	Mineral oil	≥ 260	280	0 to +130	Good	60
KP1 GREASE	PTFE	Perfluoropolyether oil	Not applicable	290	-30 to +200	Fair	60
SHELL ALVANIA GREASE S2	Lithium	Mineral oil	181	275	-10 to +110	Fair	70
SHELL ALVANIA GREASE S3	Lithium	Mineral oil	182	242	-10 to +110	Fair	70
SHELL SUNLIGHT GREASE 2	Lithium	Mineral oil	200	274	-10 to +110	Fair	70
WPH GREASE	Urea ⁽³⁾	Poly- α -olefin oil	259	240	-40 to +150	Fair	70
NIGLUBE RSH	Sodium Complex	Glycol oil	≥ 260	270	-20 to +140	Fair	60
PALMAX RBG	Lithium Complex	Mineral oil	216	300	-10 to +130	Good	70
MULTEMP PS No.2	Lithium	Poly- α -olefin oil + Diester oil ⁽⁴⁾	190	275	-50 to +110	Poor	100
MOLYKOTE(R) FS-3451GREASE	PTFE	Fluorosilicone oil ⁽⁵⁾	Not applicable	285	0 to +180	Fair	70
UME GREASE	Urea ⁽³⁾	Mineral oil	≥ 260	272	-10 to +130	Fair	70
RW1 GREASE	Urea ⁽³⁾	Mineral oil	≥ 260	300	-10 to +130	Fair	70
HA1 GREASE	Urea ⁽³⁾	Ether oil	≥ 260	290	-40 to +160	Fair	70
HA2 GREASE	Urea ⁽³⁾	Ether + Poly- α -olefin oil	≥ 260	295	-30 to +170	Fair	70
KLUBERSYNTH HB 72-52	Urea ⁽³⁾	Ester oil ⁽⁴⁾	250	295	-30 to +160	Fair	70
NOXLUB KF0921	PTFE	Perfluoropolyether oil	Not applicable	280	-40 to +200	Fair	70
ECH GREASE	Carbon Black	Perfluoropolyether oil	Not applicable	205	-30 to +260	Fair	60
FWG GREASE	Urea ⁽³⁾	Mineral oil + Poly- α -olefin oil	≥ 260	268	-30 to +150	Fair	70
HT1 GREASE	Urea ⁽³⁾	Poly- α -olefin oil	≥ 260	236	-40 to +150	Fair	100
ARAPEN RB320	Lithium-Calcium	Mineral oil	177	305	-10 to +80	Fair	70
SHELL GADUSRAIL S4 HIGH SPEED EUFR	Lithium	Mineral oil	188	266	-10 to +110	Fair	100

- Notes**
- ⁽¹⁾ If grease will be used at the upper or lower limit of the temperature range or in a special environment such as a vacuum, please consult NSK.
 - ⁽²⁾ For short-term operation or when adequate cooling is provided, grease may be used at speeds exceeding the above limits provided the supply of grease is appropriate.
 - ⁽³⁾ Urea-based grease causes fluorine-based material to deteriorate.
 - ⁽⁴⁾ Ester-based grease causes acrylic rubber material to swell.
 - ⁽⁵⁾ Silicone-based grease causes silicone-based material to swell.

12. BEARING MATERIALS

12.1	Materials for Bearing Rings and Rolling Elements A 244
12.2	Cage Materials A 245
12.3	Characteristics of Bearing, Shaft, and Housing Materials A 246
12.4	Technical Data A 248
12.4.1	Comparison of National Standards of Rolling Bearing Steel A 248
12.4.2	Long-Life Bearing Steel (NSK Z Steel) A 250
12.4.3	Dimensional Stability of Bearing Steel A 252
12.4.4	Fatigue Analysis A 254
	(1) Measurement of Fatigue Degree A 254
	(2) Surface and Subsurface Fatigue A 256
12.4.5	Hi-TF Bearings and Super-TF Bearings A 258
	(1) Hi-TF Bearings, Super-TF Bearings, and TF Technology A 258
	(2) TF Technology A 258
	(3) Material Properties of Hi-TF Bearings and Super-TF Bearings A 259
	(4) Service Life Under Contaminated Lubrication Conditions A 260
	(5) Service Life Under Clean Lubrication Conditions A 260
	(6) Service Life Under Boundary Lubrication Conditions A 261
	(7) Wear and Seizure Resistance A 261
	(8) Heat Resistance A 261
12.4.6	Physical Properties of Representative Polymers Used as Bearing Material A 262
12.4.7	Characteristics of Nylon Material for Cages A 264
12.4.8	Heat-Resistant Resin Materials for Cages A 266



12. BEARING MATERIALS

Bearing rings and rolling elements of rolling bearings are subjected to repetitive high pressure with a small amount of sliding. Tension, compression, and sliding contact with the rolling elements and either or both of the bearing rings impact the cage. Therefore, the materials used for the rings, rolling elements, and cages require the following characteristics:

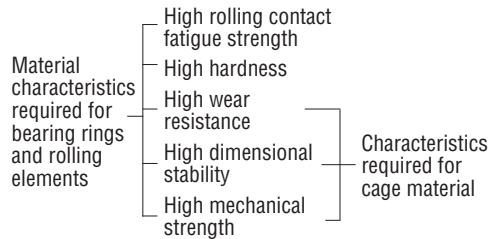

Other necessary characteristics, such as ease of production, shock and heat resistance, and corrosion resistance, are required depending on individual applications.

12.1 Materials for Bearing Rings and Rolling Elements

Primarily, high-carbon-chromium bearing steel (Table 12.1) is used for the bearing rings and rolling elements. Most NSK bearings are made of SUJ2 steel, while larger bearings generally use SUJ3 (additional types are listed in Table 12.1). The chemical composition of SUJ2 is approximately the same as AISI 52100, DIN 100 Cr6, and BS 535A99. Bearings subjected to very severe shock loads often utilize carburized low-carbon alloy steels such as chrome steel, chrome-molybdenum steel, nickel-chrome-molybdenum steel, etc. Such steels, when they are carburized to the proper depth and have sufficient surface hardness, are more shock-resistant than normal, through-hardened bearing steels because of their softer energy-absorbing core. The chemical composition of common carburized bearing steels is listed in Table 12.2.

Table 12.1 Chemical Composition of High-Carbon-Chromium Bearing Steel (Major Elements)

Standard	Designation	Chemical Composition (%)						
		C	Si	Mn	P	S	Cr	Mo
JIS G 4805	SUJ 2	0.95 to 1.10	0.15 to 0.35	Less than 0.50	Less than 0.025	Less than 0.025	1.30 to 1.60	—
	SUJ 3	0.95 to 1.10	0.40 to 0.70	0.90 to 1.15	Less than 0.025	Less than 0.025	0.90 to 1.20	—
	SUJ 4	0.95 to 1.10	0.15 to 0.35	Less than 0.50	Less than 0.025	Less than 0.025	1.30 to 1.60	0.10 to 0.25
ASTM A 295	52100	0.93 to 1.05	0.15 to 0.35	0.25 to 0.45	Less than 0.025	Less than 0.015	1.35 to 1.60	Less than 0.10

Table 12.2 Chemical Composition of Carburizing Bearing Steels (Major Elements)

Standard	Designation	Chemical Composition (%)							
		C	Si	Mn	P	S	Ni	Cr	Mo
JIS G 4052	SCr 420 H	0.17 to 0.23	0.15 to 0.35	0.55 to 0.95	Less than 0.030	Less than 0.030	Less than 0.25	0.85 to 1.25	—
	SCM 420 H	0.17 to 0.23	0.15 to 0.35	0.55 to 0.95	Less than 0.030	Less than 0.030	Less than 0.25	0.85 to 1.25	0.15 to 0.35
	SNCM 220 H	0.17 to 0.23	0.15 to 0.35	0.60 to 0.95	Less than 0.030	Less than 0.030	0.35 to 0.75	0.35 to 0.65	0.15 to 0.30
	SNCM 420 H	0.17 to 0.23	0.15 to 0.35	0.40 to 0.70	Less than 0.030	Less than 0.030	1.55 to 2.00	0.35 to 0.65	0.15 to 0.30
JIS G 4053	SNCM 815	0.12 to 0.18	0.15 to 0.35	0.30 to 0.60	Less than 0.030	Less than 0.030	4.00 to 4.50	0.70 to 1.00	0.15 to 0.30
ASTM A 534	8620 H	0.17 to 0.23	0.15 to 0.35	0.60 to 0.95	Less than 0.025	Less than 0.015	0.35 to 0.75	0.35 to 0.65	0.15 to 0.25
	4320 H	0.17 to 0.23	0.15 to 0.35	0.40 to 0.70	Less than 0.025	Less than 0.015	1.55 to 2.00	0.35 to 0.65	0.20 to 0.30
	9310 H	0.07 to 0.13	0.15 to 0.35	0.40 to 0.70	Less than 0.025	Less than 0.015	2.95 to 3.55	1.00 to 1.40	0.08 to 0.15

Table 12.3 Chemical Composition of High-Speed Steel for Bearings Used at High Temperatures

Standard	Designation	Chemical Composition (%)											
		C	Si	Mn	P	S	Cr	Mo	V	Ni	Cu	Co	W
AISI	M50	0.77 to 0.85	Less than 0.25	Less than 0.35	Less than 0.015	Less than 0.015	3.75 to 4.25	4.00 to 4.50	0.90 to 1.10	Less than 0.10	Less than 0.10	Less than 0.25	Less than 0.25

NSK uses highly pure vacuum-degassed bearing steel containing minimal oxygen, nitrogen, and hydrogen compound impurities. The rolling fatigue life of bearings has been remarkably improved using this material combined with the appropriate heat treatment. For special-purpose bearings, high-temperature bearing steel, which has superior heat resistance, and stainless steel with good corrosion resistance may be used. The chemical composition of these special materials are given in Tables 12.3 and 12.4.

12.2 Cage Materials

The main types of low carbon steels used for pressed cages are shown in Table 12.5. Depending on the application, brass or stainless steel may be used. For machined cages, high-strength brass (Table 12.6) or carbon steel (Table 12.5) is used. Synthetic resin is also sometimes used.

Table 12.4 Chemical Composition of Stainless Steel for Rolling Bearing (Major Elements)

Standard	Designation	Chemical Composition (%)						
		C	Si	Mn	P	S	Cr	Mo
JIS G 4303	SUS 440 C	0.95 to 1.20	Less than 1.00	Less than 1.00	Less than 0.040	Less than 0.030	16.00 to 18.00	Less than 0.75
SAE J 405	51440 C	0.95 to 1.20	Less than 1.00	Less than 1.00	Less than 0.040	Less than 0.030	16.00 to 18.00	Less than 0.75

Table 12.5 Chemical Composition of Steel Sheet and Carbon Steel for Cages (Major Elements)

Classification	Standard	Designation	Chemical Composition (%)				
			C	Si	Mn	P	S
Steel sheet and strip for pressed cages	JIS G 3141	SPCC	Less than 0.12	—	Less than 0.50	Less than 0.04	Less than 0.045
	BAS 361	SPB 2	0.13 to 0.20	Less than 0.30	0.25 to 0.60	Less than 0.03	Less than 0.030
	JIS G 3311	S 50 CM	0.47 to 0.53	0.15 to 0.35	0.60 to 0.90	Less than 0.03	Less than 0.035
Carbon steel for machined cages	JIS G 4051	S 25 C	0.22 to 0.28	0.15 to 0.35	0.30 to 0.60	Less than 0.03	Less than 0.035

Remark BAS refers to the Japanese Bearing Association Standard.

Table 12.6 Chemical Composition of High-Strength Brass for Machined Cages

Standard	Designation	Chemical Composition (%)								
		Cu	Zn	Mn	Fe	Al	Sn	Ni	Impurities	
									Pb	Si
JIS H 5120	CAC301 (HBsC 1)	55.0 to 60.0	33.0 to 42.0	0.1 to 1.5	0.5 to 1.5	0.5 to 1.5	Less than 1.0	Less than 1.0	Less than 0.4	Less than 0.1
JIS H 3250	C 6782	56.0 to 60.5	Residual	0.5 to 2.5	0.1 to 1.0	0.2 to 2.0	—	—	Less than 0.5	—

Remark Improved HBsC 1 is also used.

12.3 Characteristics of Bearing, Shaft, and Housing Materials

Rolling bearings must be able to support high loads, run at high speeds, and endure long periods of operation. It is also important to know the material characteristics of the shaft and housing to maximize bearing performance. Physical and mechanical properties of typical bearing, shaft, and housing materials are shown in Table 12.7.

Table 12.7 Physical and Mechanical Properties of Bearing, Shaft, and Housing Materials

	Material	Heat Treatment	Density g/cm ³	Specific Heat kJ/(kg·K)	Thermal Conductivity W/(m·K)	Electric Resistance μΩ·cm	Linear Expansion Coeff. (0 to 100 °C) × 10 ⁻⁶ /°C	Young's Modulus MPa (kgf/mm ²)	Yield Point MPa (kgf/mm ²)	Tensile Strength MPa (kgf/mm ²)	Elongation %	Hardness HB	Remarks			
Bearing	SUJ2	Quenching, tempering	7.83	0.47	46	22	12.5	208 000 {21 200}	1 370 {140}	1 570 to 1 960 {160 to 200}	0.5 Max.	650 to 740	High-carbon-chrome bearing steel No. 2			
	SUJ2	Spheroidizing annealing	7.86						420 {43}	647 {66}	27	180				
	SCr420	Quenching, low temp tempering	7.83						48	21	12.8	882 {90}	1 225 {125}	15	370	Chrome steel
	SAE4320 (SNCM420)	Quenching, low temp tempering							44	20	11.7	902 {92}	1 009 {103}	16	**293 to 375	Nickel-chrome-molybdenum steel
	SNCM815	Quenching, low temp tempering							40	35	—	—	*1 080 {110} Min.	*12 Min.	*311 to 375	
	SUS440C	Quenching, low temp tempering	7.68	0.46	24	60	10.1	200 000 {20 400}	1 860 {190}	1 960 {200}	—	**580	Martensitic stainless steel			
	SPCC	Annealing	7.86	0.47	59	15	11.6	—	—	*275 {28} Min.	*32 Min.	—	Cold rolled steel plate			
	S25C	Annealing		0.48	50	17	11.8	206 000 {21 000}	323 {33}	431 {44}	33	120	Carbon steel for machine structures			
CAC301 (HB-C1)	—	0.38		123	6.2	19.1	103 000 {10 500}	—	*431 {44} Min.	*20 Min.	—	High-tension brass				
Shaft	S45C	Quenching, 650 °C tempering	7.83	0.48	47	18	12.8	207 000 {21 100}	440 {45}	735 {75}	25	217	Carbon steel for machine structures			
	SCr430	Quenching, 520 to 620 °C fast cooling							—	*637 {65} Min.	*784 {80} Min.	*18 Min.	*229 to 293	Chrome steel		
	SCr440	Quenching, 520 to 620 °C fast cooling							45	23	12.5	*784 {80} Min.	*930 {95} Min.		*13 Min.	*269 to 331
	SCM420	Quenching, 150 to 200 °C air cooling							48	21	12.8	—	*930 {95} Min.	*14 Min.	*262 to 352	Chrome-molybdenum steel
	SNCM439	Quenching, 650 °C tempering							38	30	11.3	207 000 {21 100}	920 {94}	1 030 {105}	18	320
	SC46	Normalizing	—	—	—	—	206 000 {21 000}	294 {30}	520 {53}	27	143	Low-carbon cast steel				
	SUS420J2	1 038 °C oil cooling, 400 °C air cooling	7.75	0.46	22	55	10.4	200 000 {20 400}	1 440 {147}	1 650 {168}	10	400	Martensitic stainless steel			
Housing	FC200	Casting	7.3	0.50	43	—	—	98 000 {10 000}	—	*200 {20} Min.	—	*217 Max.	Gray cast iron			
	FCD400	Casting	7.0	0.48	20	—	11.7	169 000 {17 200}	*250 {26} Min.	*400 {41} Min.	*12 Min.	*201 Max.	Spheroidal graphite cast iron			
	A1100	Annealing	2.69	0.90	222	3.0	23.7	70 600 {7 200}	34 {3.5}	78 {8}	35	—	Pure aluminum			
	AC4C	Casting	2.68	0.88	151	4.2	21.5	72 000 {7 350}	88 {9}	167 {17}	7	—	Aluminum alloy for sand casting			
	ADC10	Casting	2.74	0.96	96	7.5	22.0	71 000 {7 240}	167 {17}	323 {33}	4	—	Aluminum alloy for die casting			
	SUS304	Annealing	8.03	0.50	15	72	15.7 to 16.8	193 000 {19 700}	245 {25}	588 {60}	60	150	Austenitic stainless steel			

Note * JIS standard or reference value.

** Though the Rockwell C scale is generally

Remark Proportional limits of SUJ2 and SCr420

used, Brinell hardness is shown for comparison.

are 833 MPa {85 kgf/mm²} and 440 MPa {45 kgf/mm²} respectively.

12.4 Technical Data

12.4.1 Comparison of National Standards of Rolling Bearing Steel

The Dimension Series of rolling bearings as mechanical elements have been standardized internationally, and the material to be used for them specified in ISO 683/17 *Heat-treated steels, alloy steels, and free-cutting steels--Part 17: Ball and roller bearing steels*. However, materials are also standardized according to the standards of individual countries and, in some cases, manufacturer modifications.

As internationalization continues, more references to these steel standards will be made. Some applicable standards and their features are described and compared in Tables 12.8 and 12.9.

Table 12.8

Applicable National Standards and Chemical Composition of High-Carbon-Chrome Bearing Steel

JIS G 4805	ASTM	Other Major National Standards	Chemical Composition (%)						Application	Remarks
			C	Si	Mn	Cr	Mo	Others		
SUJ2	—	—	0.95 to 1.10	0.15 to 0.35	≤0.50	1.30 to 1.60	≤0.08	*1	Typical steel for small- and medium-size bearings	Equivalent to each other though there are slight differences in the ranges.
—	A 295-89 52100	—	0.93 to 1.05	0.15 to 0.35	0.25 to 0.45	1.35 to 1.60	≤0.10	P ≤ 0.025 S ≤ 0.015		
—	—	100Cr6 (DIN)	0.90 to 1.05	0.15 to 0.35	0.25 to 0.40	1.40 to 1.65	—	—		
—	—	100C6 (NF)	0.95 to 1.10	0.15 to 0.35	0.20 to 0.40	1.35 to 1.60	≤0.08	P ≤ 0.030 S ≤ 0.025		
—	—	535A99 (BS)	0.95 to 1.10	0.10 to 0.35	0.40 to 0.70	1.20 to 1.60	—	*1		
SUJ3	—	—	0.95 to 1.10	0.40 to 0.70	0.90 to 1.15	0.90 to 1.20	≤0.08	*1	For large-size bearings	SUJ3 is equivalent to Grade 1. Grade 2 has better quenching capability
—	A 485-03 Grade 1	—	0.90 to 1.05	0.45 to 0.75	0.90 to 1.20	0.90 to 1.20	≤0.10	P ≤ 0.025 S ≤ 0.015		
—	A 485-03 Grade 2	—	0.85 to 1.00	0.50 to 0.80	1.40 to 1.70	1.40 to 1.80	≤0.10	P ≤ 0.025 S ≤ 0.015		
SUJ4	—	—	0.95 to 1.10	0.15 to 0.35	≤0.50	1.30 to 1.60	0.10 to 0.25	*1	Rarely used	Better quenching capability than SUJ2
SUJ5	—	—	0.95 to 1.10	0.40 to 0.70	0.90 to 1.15	0.90 to 1.20	0.10 to 0.25	*1	For extra large bearings and thin-walled bearings	Though Grade 3 is equivalent to SUJ5, quenching capability of Grade 3 is better than SUJ5.
—	A 485-03 Grade 3	—	0.95 to 1.10	0.15 to 0.35	0.65 to 0.90	1.10 to 1.50	0.20 to 0.30	P ≤ 0.025 S ≤ 0.015		

Note *1: P ≤ 0.025, S ≤ 0.025

Remark ASTM: Standard of American Society

of Testing Materials, DIN: German Standard, NF: French Standard, BS: British Standard

Table 12.9 JIS and ASTM Standards and Chemical Composition of Carburizing Bearing Steel

JIS G 4052 G 4053	ASTM A 534-90	C	Chemical Composition (%)						Application	Remarks
			Si	Mn	Ni	Cr	Mo	Others		
SCr420H	—	0.17 to 0.23	0.15 to 0.35	0.55 to 0.95	≤0.25	0.85 to 1.25	—	*2	For small bearings	Similar steel type
—	5120H	0.17 to 0.23	0.15 to 0.35	0.60 to 1.00	—	0.60 to 1.00	—	*3		
SCM420H	—	0.17 to 0.23	0.15 to 0.35	0.55 to 0.95	≤0.25	0.85 to 1.25	0.15 to 0.35	*2	For small bearings	Similar steel type, though quenching capability of 4118H is inferior to SCM420H
—	4118H	0.17 to 0.23	0.15 to 0.35	0.60 to 1.00	—	0.30 to 0.70	0.08 to 0.15	*3		
SNCM220H	—	0.17 to 0.23	0.15 to 0.35	0.60 to 0.95	0.35 to 0.75	0.35 to 0.65	0.15 to 0.30	*2	For small bearings	Equivalent, though there are slight differences
—	8620H	0.17 to 0.23	0.15 to 0.35	0.60 to 0.95	0.35 to 0.75	0.35 to 0.65	0.15 to 0.25	*3		
SNCM420H	—	0.17 to 0.23	0.15 to 0.35	0.40 to 0.70	1.55 to 2.00	0.35 to 0.65	0.15 to 0.30	*2	For medium bearings	Equivalent, though there are slight differences
—	4320H	0.17 to 0.23	0.15 to 0.35	0.40 to 0.70	1.55 to 2.00	0.35 to 0.65	0.20 to 0.30	*3		
SNCM815	—	0.12 to 0.18	0.15 to 0.35	0.30 to 0.60	4.00 to 4.50	0.70 to 1.00	0.15 to 0.30	*2	For large bearings	Similar steel type
—	9310H	0.07 to 0.13	0.15 to 0.35	0.40 to 0.70	2.95 to 3.55	1.00 to 1.45	0.08 to 0.15	*3		

Note *2: P ≤ 0.030, S ≤ 0.030 *3: P ≤ 0.025, S ≤ 0.015

12.4.2 Long-Life Bearing Steel (NSK Z Steel)

The rolling fatigue life of high-carbon chrome bearing steel (SUJ2, SAE52100) used for rolling bearings is greatly affected by non-metallic inclusions. Non-metallic inclusions are roughly divided into three-types: sulfide, oxide, and nitride. A long-term life test showed that oxide non-metallic inclusions exert a particularly adverse effect on rolling fatigue life.

Fig. 12.1 shows the parameter (oxygen content) indicating the amount of oxide non-metallic inclusions as it relates to life. The oxygen amount in steel was minimized as much as possible by reducing impurities (Ti, S) substantially, thereby achieving a decrease in oxide non-metallic inclusions. The resulting long-life steel is known as Z steel. Z steel is an achievement of improved steelmaking facilities and operating conditions made possible by cooperation with steel makers using data from numerous life tests. A graph of the oxygen content in steel over the last 25 years is shown in Fig. 12.2.

The results of a life test with the sample materials in Fig. 12.2 are shown in Fig. 12.3. Life tends to become longer with decreasing oxygen content in steel. High-quality Z steel has a life span which is about 1.8 times longer than that of conventional degassed steel.

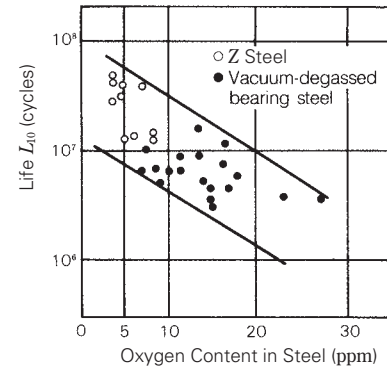

Fig. 12.1 Oxygen Content in Steel and Life of Bearing Steel

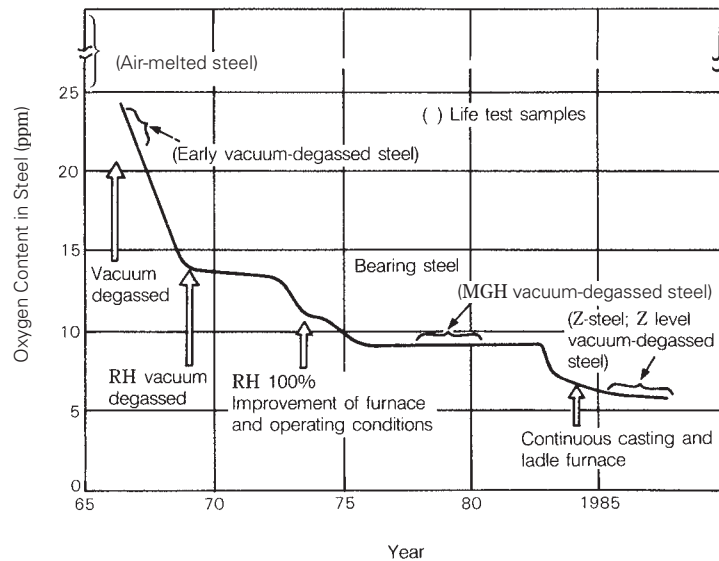
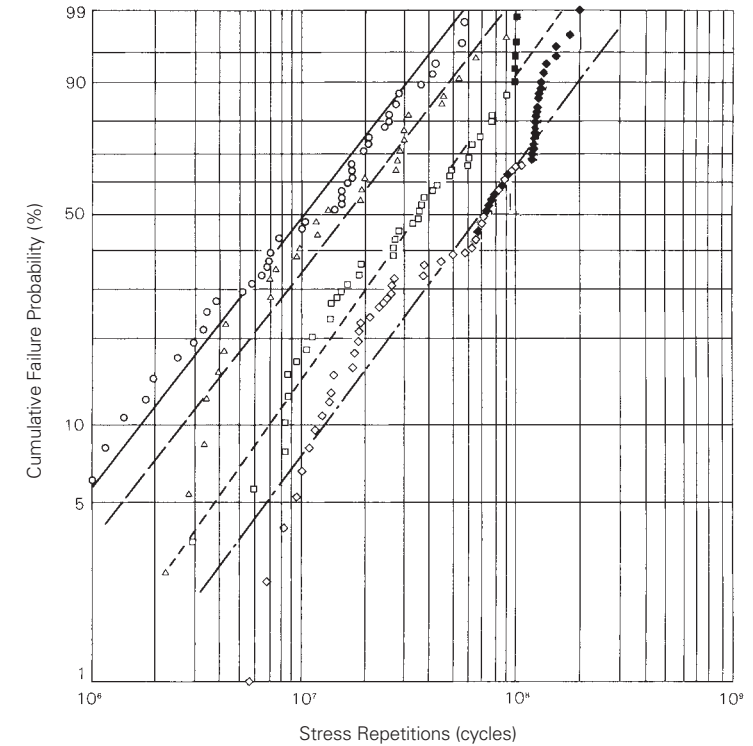

Fig. 12.2 Change in Oxygen Content of NSK Bearing Steels



Classification	Test quantity	Failed quantity	Weibull slope	L_{10}	L_{50}
○ Air-melted steel	44	44	1.02	1.67×10^6	1.06×10^7
△ Vacuum-degassed steel	30	30	1.10	2.82×10^6	1.55×10^7
□ MGH vacuum-degassed steel	46	41	1.16	6.92×10^6	3.47×10^7
◇ Z steel	70	39	1.11	1.26×10^7	6.89×10^7

Remark Testing of bearings marked with ■ and ◆ had not yet completed.

Fig. 12.3 Bearing Steel Life Test Results

12.4.3 Dimensional Stability of Bearing Steel

Sectional changes or changes in the dimensions of rolling bearings over time is called aging deformation. When the inner ring develops expansion due to such deformation, there is a resulting decrease in the interference between the shaft and inner ring. This becomes one of the causes of inner ring creep. Creep (a phenomenon where the shaft and inner ring slip mutually) causes the bearing to generate excess heat that may result in seizure, resulting in critical damage to the entire machine. Consequently, appropriate measures must be taken against aging deformation of the bearing depending on the application.

Aging deformation of bearings may be attributed to secular thermal decomposition of retained austenite in steel after heat treatment. The bearing develops gradual expansion along with phase transformation.

The dimensional stability of the bearings, therefore, varies in accordance with the relative relationship between tempering during heat treatment and the bearing's operating temperature. Dimensional stability increases with rising tempering temperature while retained austenite decomposition gradually expands as the bearing's operating temperature rises.

Fig. 12.4 shows how temperature influences the bearing's dimensional stability. The right side of the figure shows the interference between the inner ring and shaft for various shaft tolerance classes as percentages of the shaft diameter. As is evident from Fig. 12.4, dimensional stability becomes more unfavorable as the bearing's temperature rises. Under these conditions, the interference between the shaft and inner ring of a general bearing is expected to decrease gradually. In this view, loosening of the fit surface must be prevented by using a bearing that has undergone a dimensional stabilization treatment.

When bearing temperature is high, there is a possibility of inner ring creep. Please contact NSK beforehand in order to select an appropriate bearing.

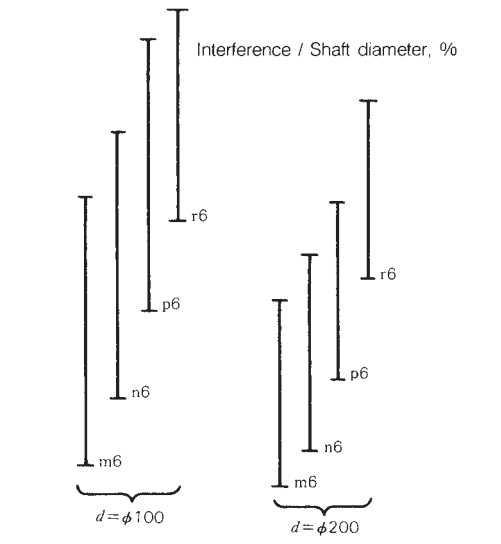
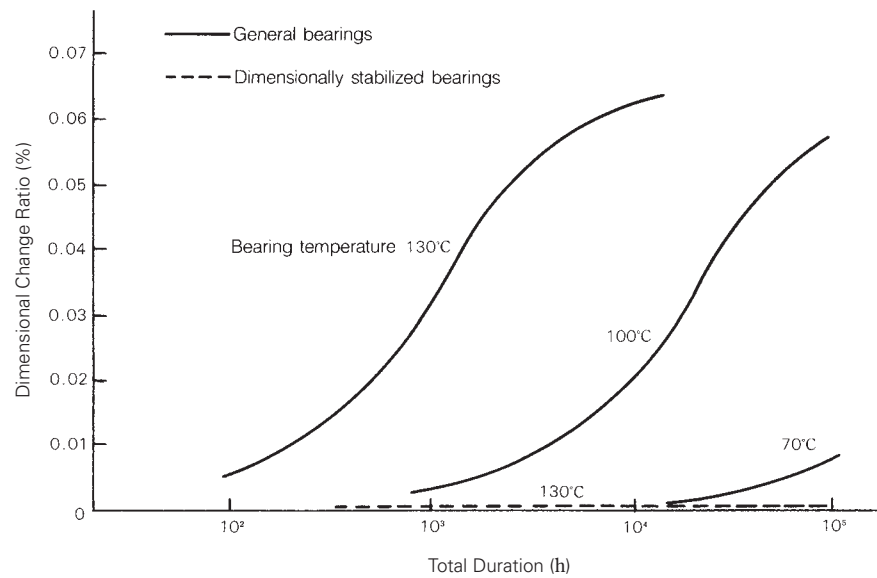

Fig. 12.4 Bearing Temperature and Dimensional Change Ratio

12.4.4 Fatigue Analysis

In order to fully predict the fatigue life of rolling bearings and estimate residual life, knowledge of all fatigue breakdown phenomena of bearings is essential. Unfortunately, this means it will take some time before we reach a stage enabling perfect prediction and estimation. However, rolling fatigue proceeds under compressive stress at the contact point and is known to cause material changes until breakdown occurs. In many cases, it is possible to estimate the degree of fatigue in bearings by detecting this material change. However, this estimation method is not effective in cases where defects in the raceway surface cause premature cracking or where chemical corrosion occurs on the raceway. In these two cases, flaking progresses ahead of material change.

(1) Measurement of Fatigue Degree

The progress of fatigue in a bearing can be determined by using an X-ray to measure changes in residual stress, diffraction half-value width, and amount of retained austenite.

These values change as fatigue progresses as shown in Fig. 12.5. As residual stress grows early and approaches a saturation value, it can be used to detect extremely small fatigue. For large fatigue, change of the diffraction half-value width and retained austenite amount correlate with the progress of fatigue. These measurements are consolidated into one parameter (fatigue index) to determine a relationship with the endurance test period of a bearing.

Measured values were collected by carrying out endurance tests with many ball, tapered roller, and cylindrical roller bearings under various loads and lubrication conditions. Simultaneously, measurements were made on bearings used in actual machines.

Fig. 12.6 summarizes the data. Variance is considerable, reflecting the complexity of fatigue. Nevertheless, there is a correlation between the fatigue index and the endurance test period or operating hours. The degree of fatigue can be handled quantitatively, albeit with some uncertainty. The description of "subsurface fatigue" in Fig. 12.6 applies when fatigue is governed by internal shearing stress. On the other hand, "surface fatigue" is correlated with earlier and more severe fatigue resulting from contamination or breakdown of the lubricating oil film.

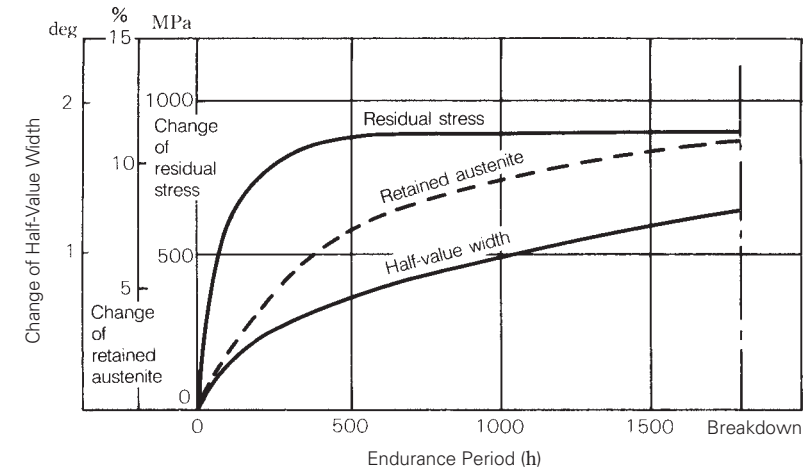

Fig. 12.5 Change in X-Ray Measurements

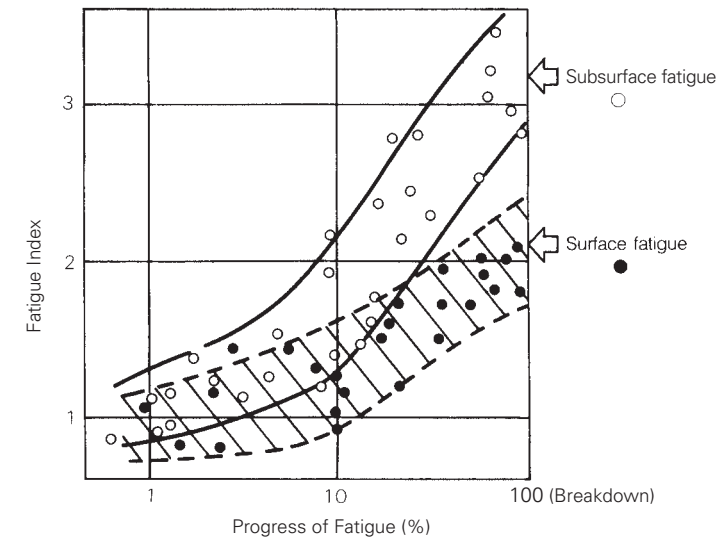

Fig. 12.6 Fatigue Progress and Fatigue Index

(2) Surface and Subsurface Fatigue

Rolling bearings have an extremely smooth finish surface and enjoy relatively satisfactory lubrication conditions. Generally, internal shearing stress below the rolling surface governs the failure of a bearing.

When shearing stress caused by rolling contact reaches a maximum level at a certain depth below the surface, a crack (the origin of a breakdown) occurs under the surface. When the raceway is broken due to such subsurface fatigue, the fatigue index measured by depth increases according to the theoretical calculation of shearing stress, as evident from the example ball bearing shown in Fig. 12.7. The fatigue pattern shown in Fig. 12.7 usually occurs when lubrication conditions are satisfactory and a sufficiently thick oil film is present at rolling contact points. The basic dynamic load rating described in this catalog is determined using data from bearing failures according to the above internal fatigue pattern. Fig. 12.8 shows an example cylindrical roller bearing with an unsatisfactory oil film subjected to an endurance test. It is evident that the amount of surface fatigue increases much earlier than indicated by the calculated life.

In this test, all bearings failed before subsurface fatigue became apparent. Thus, bearing failure due to surface fatigue is mostly attributed to lubrication conditions such as insufficient oil film due to excessively low oil viscosity or entry of foreign material or moisture into the lubricant.

Therefore, bearing failure induced by surface fatigue occurs before that of subsurface fatigue in most bearing applications, even though subsurface fatigue is the metric used to determine the original life.

Fatigue analysis has shown that bearings used in actual machines overwhelmingly show the surface fatigue pattern of failure instead of the subsurface pattern.

Knowing the distribution of the fatigue index of bearings in use leads to an increased understanding of residual life, lubrication, and load conditions.

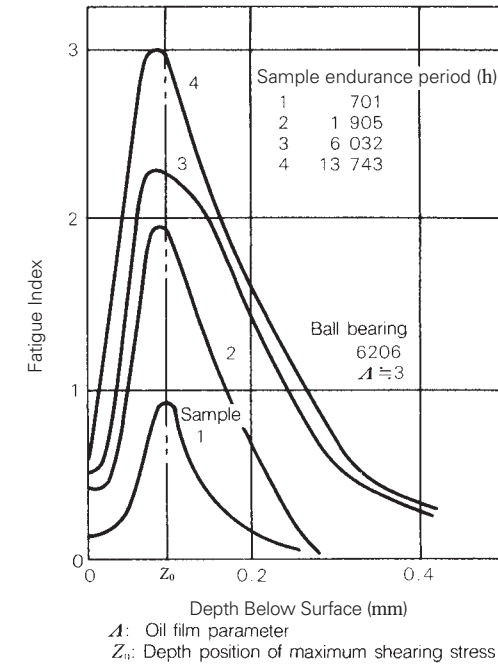

Fig. 12.7 Progress of Subsurface Fatigue

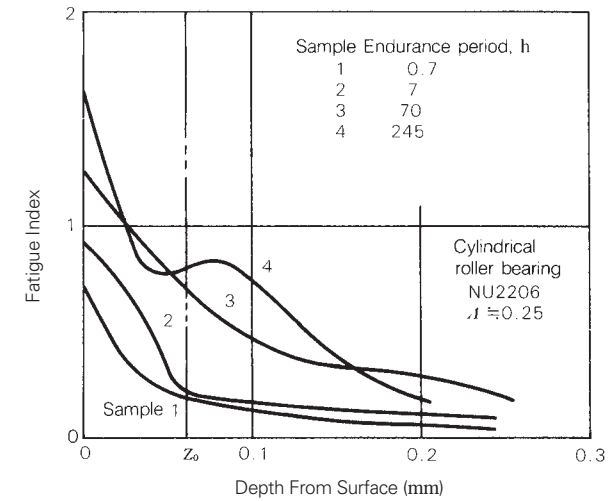

Fig. 12.8 Progress of Surface Fatigue

12.4.5 Hi-TF Bearings and Super-TF Bearings

(1) Hi-TF Bearings, Super-TF Bearings, and TF Technology

In its quest for longer bearing service life, NSK has spent many years analyzing the mechanisms of fatigue in bearings, researching and developing materials and heat treatment processes, and optimizing for operating conditions. The range of approaches to achieving longer service life taken by our research team is shown in Fig. 12.9. Technology incorporated in our Hi-TF bearings and Super-TF bearings is designed to maximize service life under conditions where bearings are subject to surface-originated flaking.

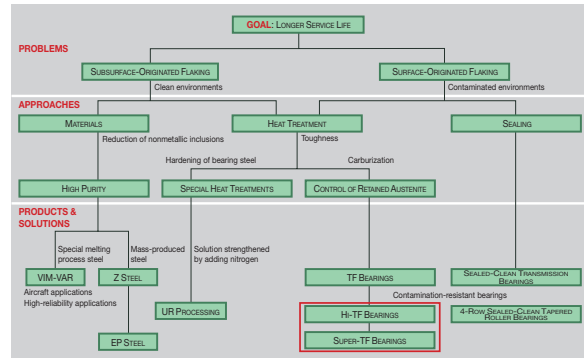

Fig. 12.9 Approaches to Achieving Longer Service Life in Bearings

(2) TF Technology

Bearings may be required to operate under clean or dirty conditions; under dirty conditions, their lubricating oil is easily contaminated. Metal particles or casting sand in the lubricating oil make dents in the contact surfaces. As shown in Fig. 12.10, stress is concentrated around these dents and eventually leads to cracking and to surface-originated flaking. The concentration of stress around a dent is expressed by the equation $[P/P_0 \propto (r/c)^{-0.24}]$, where “ r ” is the radius at the shoulder of the dent and “ $2c$ ” is the shoulder-to-shoulder width of the dent. The greater the value of “ r/c ”, the smaller the stress concentration and the longer the service life of the bearing.

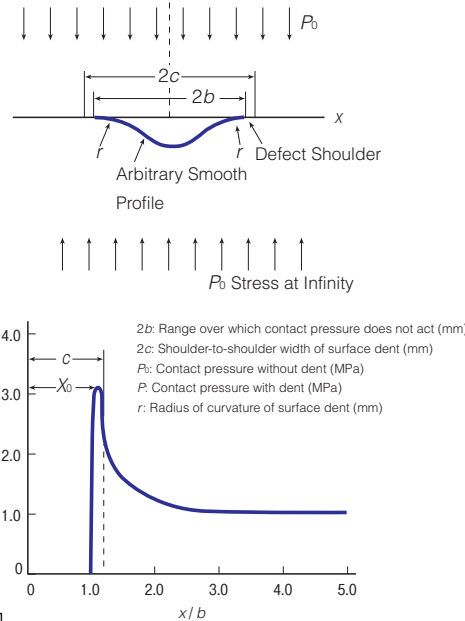

Fig. 12.10 Concentration of Stress around a Surface Dent

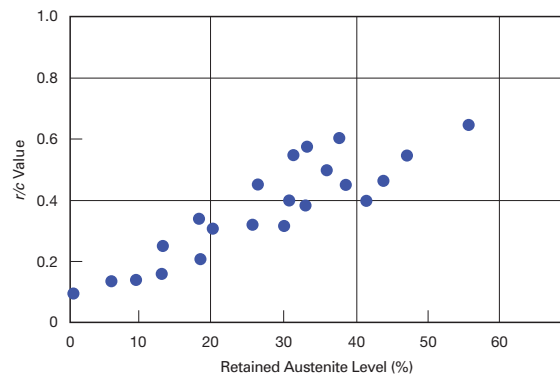

Fig. 12.11 Relationship of r/c Value to Retained Austenite Level

(3) Material Properties of Hi-TF Bearings and Super-TF Bearings

NSK has developed Hi-TF and Super-TF bearings as two Series of bearings that offer longer service life exceeding that of TF Bearings. As mentioned, the approach to achieving long service life taken in Super-TF bearings is to minimize the concentration of stress around the shoulders of surface dents. A high level of retained austenite helps achieve this and maximizes r/c values. However, austenite itself has a soft microstructure and reduces the hardness of the bearing material. In order to meet the seemingly conflicting needs for greater hardness of the bearing material and a higher level of retained austenite, NSK adopted a technique that both promotes uniform distribution and reduces the diameter of carbide and carbonitride particles in the bearing material.

To this end, our researchers developed a new type of steel that has the proper quantity of elements used in the formation of carbides and developed a proprietary process to impart minute carbides and nitride into the material surface. Hi-TF bearings contain a specific amount of added chrome, while Super-TF bearings contain a specific amount of added chrome and molybdenum. Figures 12.12 and 12.13 illustrate the image analysis results of carbide distribution in the structures of Super-TF bearings and ordinary carburized steel bearings. It is clear that Super-TF bearings have a greater amount of fine-size carbide and carbonitride particles. Fig. 12.14 shows that the formations of finer carbide and carbonitride particles give Hi-TF bearings and Super-TF bearings a greater degree of hardness and higher retained austenite levels than those of TF Bearings. As a result, Hi-TF bearings and Super-TF bearings achieve a higher r/c value. (Fig. 12.15)

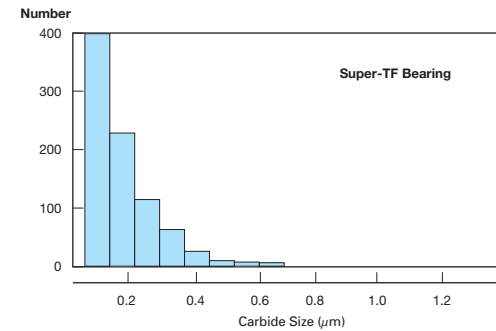

Fig. 12.12 Average Diameter of Carbide and Carbonitride Particles in a Super-TF Bearing

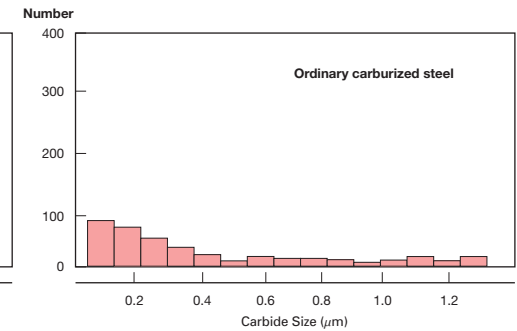

Fig. 12.13 Average Diameter of Carbide Particles in an Ordinary Carburized Steel Bearing

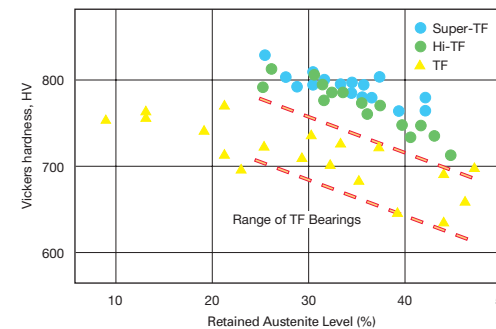

Fig. 12.14 Relationship of Material Hardness and Retained Austenite Level

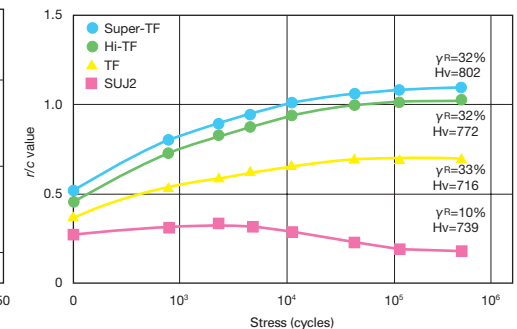

Fig. 12.15 Change of r/c Value Under Repeated Stress

(4) Service Life Under Contaminated Lubrication Conditions

Table 12.10 and Fig. 12.17 show the results of service life tests conducted under contaminated lubrication conditions with L44649/10 tapered roller bearings. If the service life of an ordinary carburized steel bearing of this type is taken as 1, then the L_{10} life of TF, Hi-TF, and Super-TF bearings would be 4.5, 7.1, and 10.2 respectively (Table 12.10). Hi-TF bearings and Super-TF bearings thus offer over seven to ten times the service life of ordinary carburized steel bearings. Service life is generally affected both by the conditions in which the bearing is used and by the amount of contamination in the lubricant. Under contaminated lubrication conditions, service life may fall to as little as 1/5 the catalog life. Hi-TF bearings and Super-TF bearings can achieve for the first time service life that exceeds the catalog life of existing products under contaminated lubrication.

Ordinary Carburized Steel	TF	Hi-TF	Super-TF
1	4.5	7.1	10.2

Table 12.10 Comparison of Service Life of L44649/10 Tapered Roller Bearings

(5) Service Life under Clean Lubrication Conditions

Fig. 12.18 shows the results of service life tests under clean lubrication conditions using Series 6206 deep groove ball bearings. Under clean lubrication, Hi-TF Bearings and Super-TF Bearings show a slightly longer service life than those made with SUJ2 steel. The most important factor is the cleanliness of the steel from which the bearing is made. Material with a greater degree of purity offers a greater degree of long-life performance.

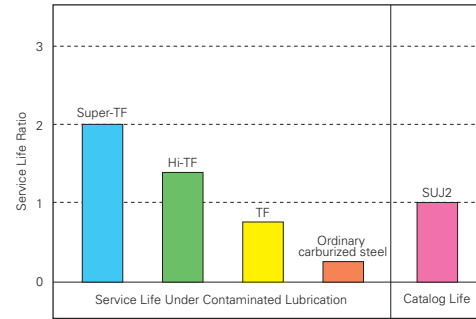

Fig. 12.16 Comparison of Service Life Under Contaminated Lubrication

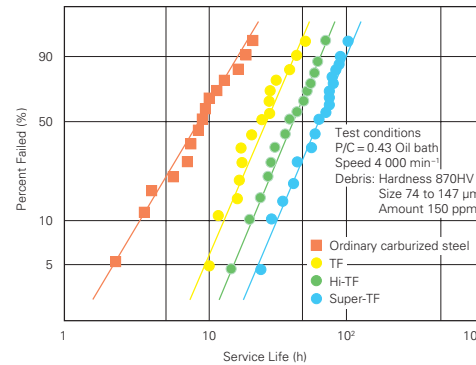

Fig. 12.17 Service Life of L44649/10 Bearings Under Contaminated Lubrication

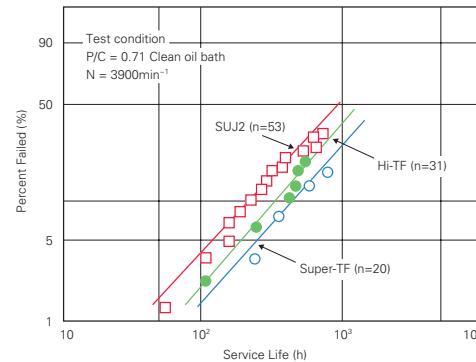

Fig. 12.18 Service Life Tests of 6206 Bearings Under Clean Lubrication

(6) Service Life Under Boundary Lubrication Conditions

Under boundary lubrication conditions where there is an insufficient EHL film, metal-to-metal contact occurs, thus reducing bearing life. Fig. 12.19 shows the results of service life tests conducted under conditions where oil film parameter Λ , which represents the ratio of the thickness of the oil film to the roughness of the surface, is very small ($\Lambda=0.3$). At this very small ratio, peeling damage occurs (Fig. 12.20), but in Hi-TF bearings and Super-TF bearings, the concentration of stress around the projections of the contact area is reduced, giving a service life approximately 4.7 times and 5.5 times greater than that of ordinary carburized steel bearings.

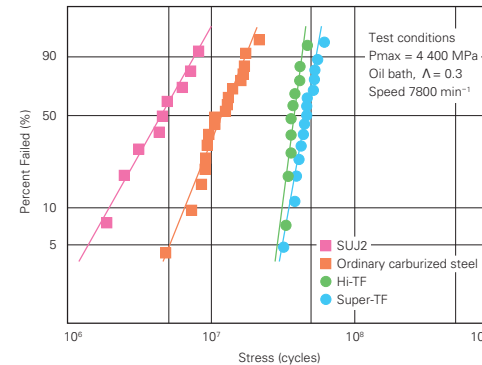

Fig. 12.19 Service Life Tests Under Boundary Lubrication Conditions

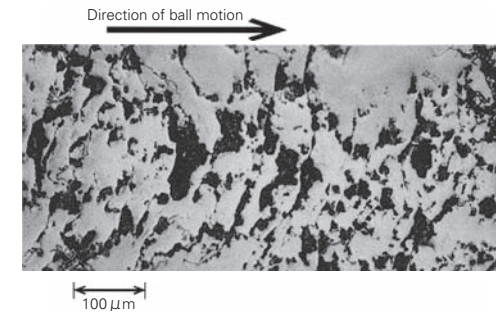

Fig. 12.20 Peeling Damage

(7) Wear and Seizure Resistance

Besides extending service life under contaminated lubrication conditions, another goal is to increase the bearing's resistance to wear and seizure by ensuring the dispersion of a large number of fine carbides and nitrides in the bearing material. Fig. 12.21 presents the results of a Sawin wear test that shows the degree of wear and the seizure limit for different types of bearing material. The test reveals that Hi-TF bearings and Super-TF bearings have superior wear resistance to both SUJ2 steel and TF bearings. Hi-TF bearings and Super-TF bearings are also 20 % to 40 % more resistant to seizure than both SUJ2 steel and TF bearings.

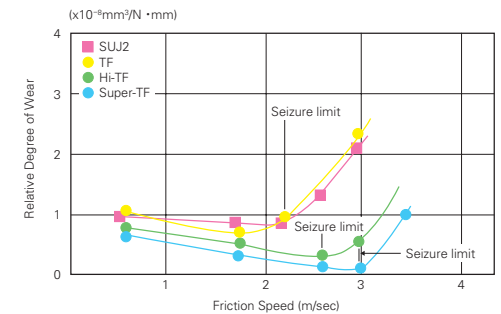

Fig. 12.21 Comparison of Wear Resistance

(8) Heat Resistance

Fig. 12.22 shows the results of service life tests conducted with Series 6206 ball bearings at 160 °C under clean lubrication conditions. Test results reveal that Super-TF bearings (heat-resistant specifications) have approximately 4 times the service life of SUJ2X26 steel bearings.

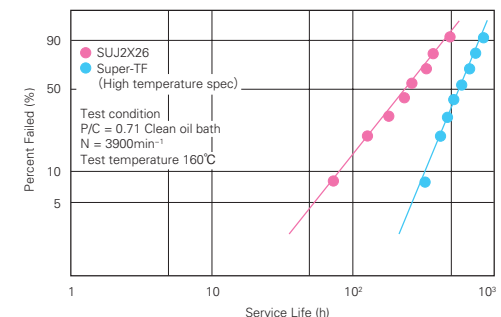

Fig. 12.22 Service Life Test of 6206 Under High Temperature Clean Lubrication

12.4.6 Physical Properties of Representative Polymers Used as Bearing Material

Because of their light weight, easy formability, and high corrosion resistance, polymers are widely used as cage materials. Polymers may be used independently, but they are usually combined with functional fillers to form a composite material. Composites can be customized to have specific properties and thus be used as bearing materials. For example, fillers can be used to impart attributes such as low friction, low wear, non-stick slip characteristics, high limit PV values, non-scrubbing of counterpart material, mechanical properties, heat resistance, and so on.

Table 12.11 shows characteristics of representative polymer materials used for bearings.

Table 12.11 Characteristics of Representative Polymers

Plastics	Elastic Modulus (GPa) ⁽¹⁾	Strength GPa ⁽¹⁾	Density g/cm ³	Specific Elastic Modulus ×10 ⁴ mm	Specific Strength ×10 ⁴ mm	Melting point °C	Glass Transition Temp °C	Thermal Deformation Temperature °C ⁽²⁾	Continuous Operating Temperature °C	Remarks
Polyethylene HDPE UHMWPE	0.115 0.5	0.03 0.025	0.96 0.94	12.6 53.2	3.3 2.7	132 136	-20 -20	75/50 75/50	— —	High creep and toughness, softening
Polyamide Nylon 6 Nylon 66	2.5 3.0	0.07 0.08	1.13 1.14	221.2 263.2	6.2 7.0	215 264	50 60	150/57 180/60	80 to 120 80 to 120	High water absorption and toughness
Nylon 11	1.25	0.04	1.04	120.2	3.8	180	—	150/55	Lower than nylon 6 or 66	Low water absorption
Polytetra fluoroethylene PTFE	0.40	0.028	2.16	18.5	1.3	327	115	120/—	260	High creep, sintering, low friction, low adhesion, inert. Stable at 290 °C
Poly buthylene terephthalate PBT	2.7	0.06	1.31	206.1	4.6	225	30	230/215	155	
Polyacetal POM Homo-polymer Co-polymer	3.2 2.9	0.07 0.06	1.42 1.41	225.3 205.7	4.9 4.3	175 165	-13 —	170/120 155/110	— 104	High hardness and toughness, low water absorption
Polyether sulfon PES	2.46	0.086	1.37	179.6	6.3	—	225	210/203	180	Usable up to 200 °C. Chemically stable
Polysulfon PSi	2.5	0.07	1.24	201.6	5.6	—	190	181/175	150	
Polyallylate (Aromatic polyester)	1.3 3.0	0.07 0.075	1.35 1.40	96.3 214.3	5.2 5.4	350 350	— —	293 293	300 260 to 300	Inert, high hardness, used as filler for PTFE. Stable up to 320 °C
Polyphenylene sulfide PPS (GF 40%)	4.2	0.14	1.64	256.1	8.5	275	94	>260	220	Hot cured at 360 °C
Polyether ether keton PEEK	1.7	0.093	1.30	130.8	7.2	335	144	152	240	
Poly-meta-phenylene isophthalic amide	10 (fiber) 7.7 (mold)	0.7 0.18	1.38 1.33	724.6 579	50.7 13.5	375 415 (decomposition)	>230 >230	280 280	220 220	Fire retardant, heat-resistant fiber
Polypromellitic imide (Aromatic polyimide) PI	3 (film)	0.17	1.43	203	7.0	Heat decomposition	417 decomposition	360/250	300 ⁽³⁾	No change in inert gas up to 350 °C
	2.5 to 3.2 (mold)	0.1	1.43	203	7.0	Heat decomposition	417 decomposition	360/250	260	Usable up to 300 °C for bearings. Sintering, no fusion (molded products)
Polyamide imide PAI	4.7	0.2	1.41	333.3	14.2	—	280	260	210	Usable up to 290 °C as an adhesive or enamel. Improved polyimide for melt molding
Polyether imide (Aromatic polyimide) PI	3.6	0.107	1.27	240.9	—	—	215	210/200	170	Improved polyimide for melt molding
Polyamino bis-maleimide	—	0.35	1.6	—	21.9	—	—	330 ⁽³⁾	260	

Notes ⁽¹⁾ GPa ≅ 10⁴ kgf/cm² = 10² kgf/mm²
⁽²⁾ If there is a slash mark "/" in the thermal
⁽³⁾ Reference value

deformation temperature column, the left value applies to 451 kPa, while all other values apply to 1.82 MPa.

12.4.7 Characteristics of Nylon Cage Material

Recently, plastic cages are increasingly used in place of metal cages in bearings. Advantages of using plastic cages include:

- (1) Light weight and favorable for use with high-speed rotation
- (2) Self-lubricating functionality and low wear. Abrasion powders are usually not produced when plastic cages are used, so a highly clean internal state can be maintained.
- (3) Low noise appropriate for silent environments
- (4) Highly corrosion resistant, no rusting
- (5) Highly shock resistant, proving durable under high moment loading
- (6) Easy molding of complicated shapes ensures high freedom of cage shape selection. Thus, better cage performance can be obtained.

Disadvantages when compared with metal cages include low heat resistance and a limited operating temperature range (normally 120 °C). Care is also necessary for use because plastic cages are sensitive to certain chemicals. Polyamide resin is a representative plastic cage material. Among polyamide resins, nylon-66 is often used because of its high heat resistance and mechanical properties.

Polyamide resin contains the amide coupling (-NHCO-) with hydrogen bonding capability in its molecular chain and is characterized by its regulation of mechanical properties and water absorption according to concentration and hydrogen bonding state. High water absorption (Fig. 12.23) of nylon 66 is generally regarded as a shortcoming because it causes dimensional distortion and deterioration of rigidity. On the other hand, water absorption helps enhance flexibility and prevents cage damage during bearing assembly when a cage is required to have a substantial holding interference for the rolling elements. This also improves toughness which is effective for shock absorption during operation. As such, this so-called shortcoming may be considered as an advantage under certain conditions.

Nylon can be improved substantially in strength and heat resistance by adding a small amount of fiber. Therefore, materials reinforced by glass fiber may be used depending on the cage type and application. To maintain deformation of the cage during bearing

assembly, a relatively small amount of glass fiber is commonly used to reinforce the cage. (Table 12.12) Nylon-66 demonstrates vastly superior performance under light operating conditions and has wide application possibilities as a mainstream plastic cage material. However, it often develops sudden deterioration under severe conditions (in high-temperature oil, etc.). Therefore, carefully monitor this material during practical operation.

As an example, Table 12.13 shows the time necessary for the endurance performance of various nylon-66 materials to drop to 50% of the initial value under several different cases. Material deterioration in oil varies depending on the kind of oil. Deterioration is excessive if the oil contains an extreme-pressure agent. Sulfurous extreme-pressure agents accelerate

deterioration more than phosphorous extreme-pressure agents and such deterioration occurs more rapidly with rising temperatures.

On the other hand, material deteriorates less in grease or air than in oil. In addition, materials reinforced with glass fiber can suppress deterioration by the reinforcement effect of glass fibers, thereby helping to extend the durability period.

Table 12.12 Example Applications With Fiber Reinforced Nylon Cages

	Bearing Type	Main Applications	Cage Material
Ball Bearing	Miniature ball bearings	VCR, IC cooling fans	Nylon 66 (Glass fiber content: 0 to 10%)
	Deep groove ball bearings	Alternators, fan motors for air conditioners	
	Angular contact ball bearings	Magnetic clutches, automotive wheels	
Roller Bearing	Needle roller bearings	Automotive transmissions	Nylon 66 (Glass fiber content: 10 to 25%)
	Tapered roller bearings	Automotive wheels	
	ET-type cylindrical roller bearings	General	
	H-type spherical roller bearings	General	

Table 12.13 Environmental Resistance of Nylon-66 Resin

Environment	Temperature, °C	Glass Content	Time Until Physical Property Value Drops to 50% (h)				Remarks
			500	1000	1500	2000	
Oil	120	0	→	→	→	→	Contains an extreme pressure additive
		D	→	→	→	→	
	140	0	→	→	→	→	Contains an extreme pressure additive
		A	→	→	→	→	
	100	A	→	→	→	→	Contains an extreme pressure additive
		120	A	→	→	→	
		0	A	→	→	→	
		A	→	→	→	→	
	130	A	→	→	→	→	
		C	→	→	→	→	
	150	0	→	→	→	→	
		B	→	→	→	→	
80	0	→	→	→	→	Contains an extreme pressure additive	
	D	→	→	→	→		
120	0	→	→	→	→		
	D	→	→	→	→		
150	0	→	→	→	→		
	D	→	→	→	→		
120	0	→	→	→	→		
	D	→	→	→	→		
140	0	→	→	→	→		
	A	→	→	→	→		
120	0	→	→	→	→		
	D	→	→	→	→		
Grease	80	0	→	→	→	→	
		D	→	→	→	→	
	120	0	→	→	→	→	
130	A	→	→	→	→		
	D	→	→	→	→		
Air	160	0	→	→	→	→	
		A	→	→	→	→	
	180	0	→	→	→	→	

Remarks: Glass content: A<B<C<D

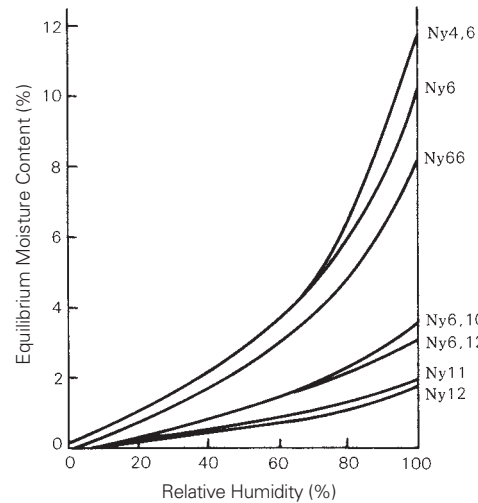

Fig. 12.23 Equilibrium Moisture Content and Relative Humidity of Various Nylons

12.4.8 Heat-Resistant Resin Materials for Cages

Currently, polyamide resin shows superior performance under medium-intensity operating environmental conditions. This feature plus its relative inexpensiveness has led to its use in increasing quantities. However, contact with acids or oils containing an extreme pressure agent or continuous use at or above 120 °C deteriorates and ages the material over time.

Super-engineering plastics should be used for the cage materials of bearings running in severe environments, such as temperatures over 150 °C or with corrosive chemicals present. Though super-engineering plastics have good material heat resistance, chemical resistance, rigidity at high temperature, and mechanical strength, they have problems with characteristics required of cage materials, such as toughness during molding or bearing assembly, weld strength, and fatigue resistance. Furthermore, the costs of these materials are high. Table 12.14 shows the properties of typical super-engineering plastics that can be injection molded into cage shapes.

Among the materials in Table 12.14, though branch-type polyphenylene sulfide (PPS) is often used, the cage design is restricted since forced-removal from the die is difficult due to poor toughness and brittleness. Moreover, PPS is not ideal as a cage material since the claw, stay, ring, or flange of the cage can be easily broken on the bearing assembly line. On the other hand, the heat-resistant plastic cage developed by NSK, is made of linear-chain high molecules which have been polymerized from molecular chains. These molecular chains do not contain branches or crosslinking, so they have high toughness compared to the former material (branch PPS). Linear PPS is not only superior in heat resistance, oil resistance, and chemical resistance, but also has good mechanical characteristics such as the potential for snap fitting (an important characteristic for cages), and high-temperature rigidity.

NSK has reduced the disadvantages associated with linear PPS, chiefly difficulty of removal from the die and slow crystallization speed, thereby establishing it as a material suitable for cages. Thus, linear PPS satisfies the required capabilities for a heat-resistant cage material that considers cost and performance.

Table 12.14 Properties of Typical Super-Engineering Plastic Materials for Cages

Classification	Polyether Sulfone (PES)	Polyether Imide (PEI)	Polyamide Imide (PAI)	Polyether Etherketon (PEEK)	Branch Polyphenylene Sulfide (PPS)	Linear Polyphenylene Sulfide (L-PPS)
Resin	Amorphous resin	Amorphous resin	Amorphous resin	Crystalline resin	Crystalline resin	Crystalline resin
Continuous Temp.	180 °C	170 °C	210 °C	240 °C	220 °C	220 °C
Physical Properties	<ul style="list-style-type: none"> ●Poor toughness (Care necessary regarding cage shape) ●Low weld strength ●Small fatigue resistance 	<ul style="list-style-type: none"> ●Poor toughness ●Low weld strength ●Low fatigue resistance 	<ul style="list-style-type: none"> ●Very brittle (No forced-removal molding) ●Special heat treatment before use ●High rigidity, after heat treatment 	<ul style="list-style-type: none"> ●Excellent toughness, wear, and fatigue resistance ●Small weld strength 	<ul style="list-style-type: none"> ●Excellent mechanical properties ●Slightly low toughness 	<ul style="list-style-type: none"> ●Excellent mechanical properties ●Good toughness ●Good dimensional stability (No water absorption)
Environmental Properties	<ul style="list-style-type: none"> ●Water absorption (Poor dimensional stability) ●Good aging resistance ●Poor stress cracking resistance 	<ul style="list-style-type: none"> ●Good aging resistance ●Poor stress cracking resistance 	<ul style="list-style-type: none"> ●Good environmental resistance 	<ul style="list-style-type: none"> ●Good environmental resistance 	<ul style="list-style-type: none"> ●Good environmental resistance 	<ul style="list-style-type: none"> ●Good environmental resistance (not affected by most chemicals, doesn't deteriorate in high temperature oil with extreme pressure additives).
Material Cost (Superiority)	3	2	5	4	1	1
Cage Application	<ul style="list-style-type: none"> ●Many performance problems ●High material price 	<ul style="list-style-type: none"> ●Many performance problems ●High material cost 	<ul style="list-style-type: none"> ●Good performance ●High material and molding cost (For special applications) 	<ul style="list-style-type: none"> ●Excellent performance ●High material cost (For special applications) 	<ul style="list-style-type: none"> ●Problems with toughness ●Cost is high compared to performance 	<ul style="list-style-type: none"> ●Reasonable cost for performance (For general applications)

13. DESIGN OF SHAFTS AND HOUSINGS

13.1 Accuracy and Surface Finish of Shafts and Housings	A 270
13.2 Shoulder and Fillet Dimensions	A 270
13.3 Bearing Seals	A 272
13.3.1 Non-Contact Seals	A 272
(1) Oil Groove Seals	A 273
(2) Flinger (Slinger) Type Seals	A 273
(3) Labyrinth Seals	A 273
13.3.2 Contact Seals	A 274
(1) Oil Seals	A 274
(2) Felt Seals	A 275

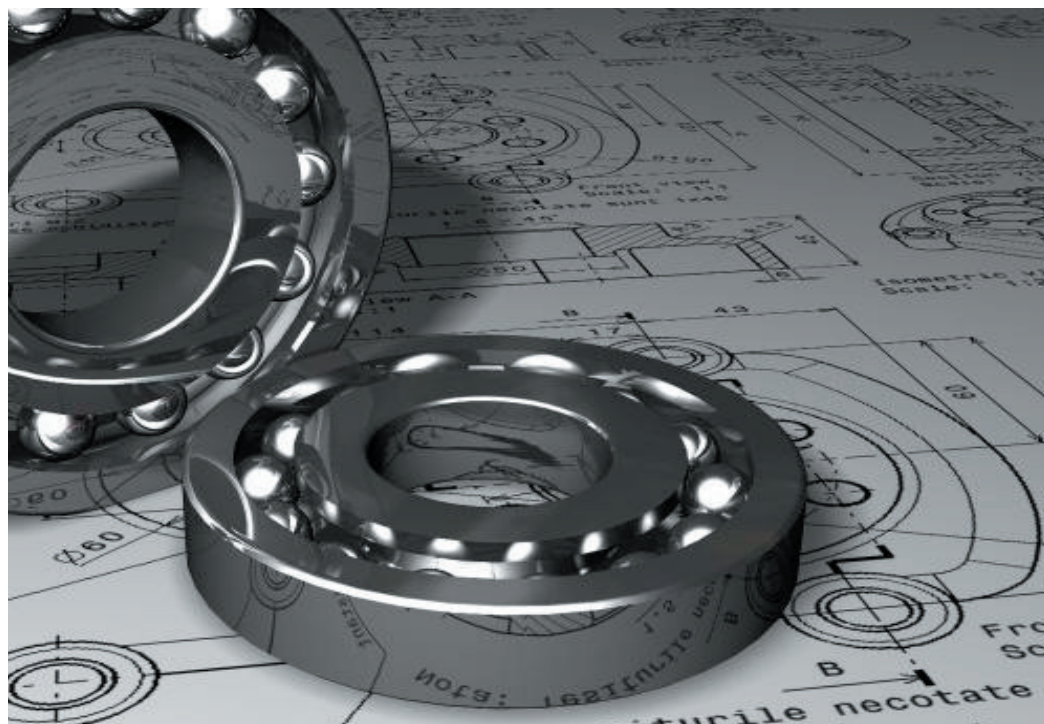

13. DESIGN OF SHAFTS AND HOUSINGS

13.1 Accuracy and Surface Finish of Shafts and Housings

If the accuracy of a shaft or housing does not meet the specification, the performance of the bearings will be affected and they will not perform to their full capability. For example, inaccuracy in the squareness of the shaft shoulder may cause misalignment of the bearing inner and outer rings, which may reduce the bearing fatigue life by adding an edge load in addition to the normal load. Cage fracture and seizure sometimes occur for this reason. Housings should be rigid in order to provide firm bearing support and are also advantageous in regards to noise, load distribution, etc.

For normal operating conditions, a turned finish or smooth bored finish is sufficient for the fitting surface; however, a ground finish is necessary for applications where vibration and noise must be low or where heavy loads are applied.

In cases where two or more bearings are mounted in a single-piece housing, the fitting surfaces of the housing bore should be designed so both bearing seats may be finished together in one operation, such as inline boring. In the case of split housings, take care in the fabrication of the housing so that the outer ring does not become deformed during installation. The tolerance and surface finish of shafts and housings for normal operating conditions are listed in Table 13.1.

Table 13.1 Tolerance and Roughness of Shaft and Housing

Item	Class of Bearings	Shaft	Housing Bore
Tolerance for Out-of-Roundness	Normal, Class 6	$\frac{IT3}{2}$ to $\frac{IT4}{2}$	$\frac{IT4}{2}$ to $\frac{IT5}{2}$
	Class 5, Class 4	$\frac{IT2}{2}$ to $\frac{IT3}{2}$	$\frac{IT2}{2}$ to $\frac{IT3}{2}$
Tolerance for Cylindricity	Normal, Class 6	$\frac{IT3}{2}$ to $\frac{IT4}{2}$	$\frac{IT4}{2}$ to $\frac{IT5}{2}$
	Class 5, Class 4	$\frac{IT2}{2}$ to $\frac{IT3}{2}$	$\frac{IT2}{2}$ to $\frac{IT3}{2}$
Tolerance for Shoulder Runout	Normal, Class 6	IT3	IT3 to IT4
	Class 5, Class 4	IT3	IT3
Roughness of Fitting Surfaces R_a	Small Bearings	0.8	1.6
	Large Bearings	1.6	3.2

Remarks This table gives general recommendation using the radius measuring method. The basic tolerance (IT) class should be selected in accordance with the bearing tolerance class. Please refer to the Appendix Table 11 (Page E016) for IT values.

If the outer ring is mounted in the housing bore with interference or a thin cross-section bearing is mounted on a shaft and housing, the tolerance of the shaft and housing should be tighter since this affects the bearing raceway directly.

13.2 Shoulder and Fillet Dimensions

The shoulders of the shaft or housing in contact with the face of a bearing must be perpendicular to the shaft center line (refer to Table 13.1). The front face side shoulder bore of the housing for a tapered roller bearing should be parallel with the bearing axis in order to avoid interference with the cage.

The fillets of the shaft and housing should not come in contact with the bearing chamfer; therefore, the fillet radius r_a must be smaller than the minimum bearing chamfer dimension r or r_1 .

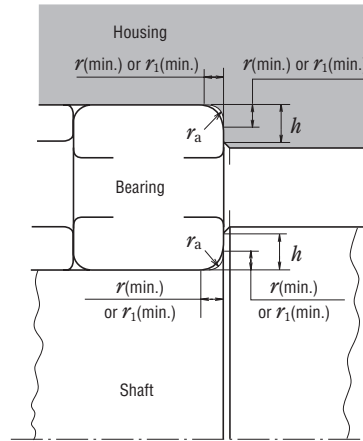

Fig. 13.1 Chamfer Dimensions, Fillet Radius of Shaft and Housing, and Shoulder Height

The shoulder heights for both shafts and housings for radial bearings should be sufficient to provide good support over the face of the bearings, but enough face should extend beyond the shoulder to permit use of special dismounting tools. The recommended minimum shoulder heights for Metric Series radial bearings are listed in Table 13.2.

Nominal dimensions associated with bearing mounting, including the proper shoulder diameters, are listed in the bearing tables. Sufficient shoulder height is particularly important for supporting the side ribs of tapered roller bearings and for cylindrical roller bearings subjected to high axial loads.

The values of h and r_a in Table 13.2 should be adopted in those cases where the fillet radius of the shaft or housing is as shown in Fig. 13.2 (a), while the values in Table 13.3 are generally used with an undercut fillet radius produced when grinding the shaft as shown in Fig. 13.2 (b).

Table 13.2 Recommended Minimum Shoulder Heights for Use With Metric Series Radial Bearings

Units : mm

Nominal Chamfer Dimensions	Shaft or Housing		
	Fillet Radius	Minimum Shoulder Heights h (min.)	
r (min.) or r_1 (min.)	r_a (max.)	Deep Groove Ball Bearings (1), Self-Aligning Ball Bearings, Cylindrical Roller Bearings (1), Solid Needle Roller Bearings	Angular Contact Ball Bearings, Tapered Roller Bearings (2), Spherical Roller Bearings
0.05	0.05	0.2	—
0.08	0.08	0.3	—
0.1	0.1	0.4	—
0.15	0.15	0.6	—
0.2	0.2	0.8	—
0.3	0.3	1	1.25
0.6	0.6	2	2.5
1	1	2.5	3
1.1	1	3.25	3.5
1.5	1.5	4	4.5
2	2	4.5	5
2.1	2	5.5	6
2.5	2	—	6
3	2.5	6.5	7
4	3	8	9
5	4	10	11
6	5	13	14
7.5	6	16	18
9.5	8	20	22
12	10	24	27
15	12	29	32
19	15	38	42

Note (1) When axial loads are applied, the shoulder height must be sufficiently higher than these values.

(2) When heavy axial loads are applied, the shoulder height must be sufficiently higher than these values.

Remarks 1. The corner fillet radius is also applicable to thrust bearings.
2. The shoulder diameter is listed instead of shoulder height in the bearing tables.

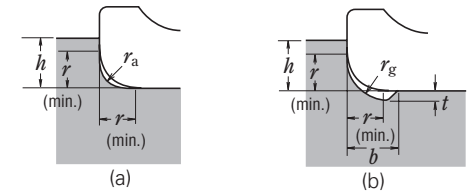

Fig. 13.2 Chamfer Dimensions, Fillet Radius, and Shoulder Height

Table 13.3 Shaft Undercut

Units : mm

Chamfer Dimensions of Inner and Outer Rings r (min.) or r_1 (min.)	Undercut Dimensions		
	t	r_g	b
1	0.2	1.3	2
1.1	0.3	1.5	2.4
1.5	0.4	2	3.2
2	0.5	2.5	4
2.1	0.5	2.5	4
2.5	0.5	2.5	4
3	0.5	3	4.7
4	0.5	4	5.9
5	0.6	5	7.4
6	0.6	6	8.6
7.5	0.6	7	10

For thrust bearings, the squareness and contact area of the supporting face for the bearing rings must be adequate. In the case of thrust ball bearings, the housing shoulder diameter D_a should be less than the pitch circle diameter of the balls, and the shaft shoulder diameter d_a should be greater than the pitch circle diameter of the balls (Fig. 13.3). For thrust roller bearings, the full contact length between rollers and rings should be supported by the shaft and housing shoulder (Fig. 13.4). These diameters, d_a and D_a , are listed in the bearing tables.

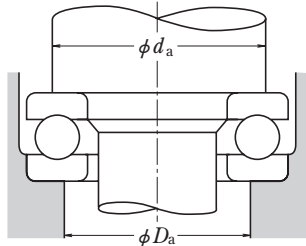

Fig. 13.3 Face-Supporting Diameters for Thrust Ball Bearings

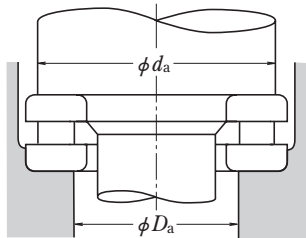

Fig. 13.4 Face-Supporting Diameters for Thrust Roller Bearings

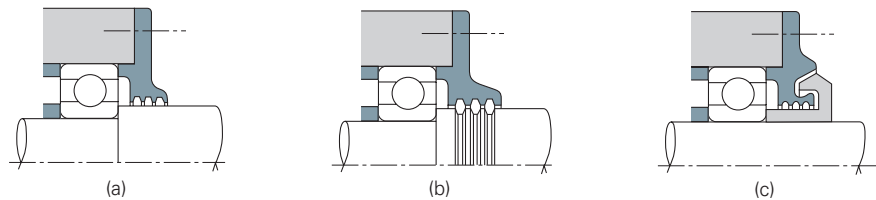

Fig. 13.5 Example Oil Grooves

13.3 Bearing Seals

To insure the longest possible life of a bearing, seals may be necessary to prevent leakage of lubricant or entry of dust, water, or other harmful material such as metallic particles. The seals must be free from excessive running friction and chance of seizure. They should also be easy to assemble and disassemble. Be sure to select a suitable seal for individual applications that considers the lubricating method.

13.3.1 Non-Contact Seals

Various sealing devices that do not contact the shaft are available, such as oil grooves, flingers, and labyrinths. Satisfactory sealing can usually be obtained with such seals because of their close running clearance. Centrifugal force may also assist in preventing internal contamination and leakage of the lubricant.

(1) Oil Groove Seals

Oil groove seals function by the use of a small gap between the shaft and housing cover in combination with multiple grooves in the housing cover and/or shaft surface (Fig. 13.5 (a), (b)). Since the use of oil grooves alone is not completely effective except at low speeds, a flinger or labyrinth seal is often combined with an oil groove seal (Fig. 13.5 (c)). The entry of dust can be impeded by packing a grease with a consistency of about 200 (NLGI Grade 4) into the grooves of the shaft and/or housing.

The smaller the gap between the shaft and housing, the greater the sealing effect; however, the shaft and housing must not come in contact while running. The recommended gaps are given in Table 13.4.

The recommended groove width is approximately 3 to 5 mm, with a depth of about 4 to 5 mm. When sealing using grooves only, there should be three or more grooves.

(2) Flinger (Slinger) Seals

A flinger is designed to force water and dust away by centrifugal force acting on any contaminants on the shaft. Sealing mechanisms with flingers inside the housing, as shown in Fig. 13.6 (a) and (b), are mainly intended to prevent oil leakage and are used in environments with relatively little dust. Dust and moisture cannot enter due to the centrifugal force of flingers as shown in Fig. 13.6 (c) and (d).

Table 13.4 Gaps Between Shafts and Housings for Oil-Groove Type Seals

Nominal Shaft Diameter	Units : mm	
	Radial Gap	
Under 50	0.25 to 0.4	
50-200	0.5 to 1.5	

(3) Labyrinth Seals

Labyrinth seals are formed by interdigitated segments attached to the shaft and housing that are separated by a very small gap. They are particularly suitable for preventing oil leakage from the shaft at high speeds. The type shown in Fig. 13.7 (a) is widely used because of its ease of assembly, but those shown in Fig. 13.7 (b) and (c) have better seal effectiveness. Normal radial and axial labyrinth seal gaps are shown in Table 13.5.

Table 13.5 Labyrinth Seal Gaps

Nominal Shaft Diameter	Units : mm	
	Labyrinth Gaps	
	Radial Gap	Axial Gap
Under 50	0.25 to 0.4	1 to 2
50-200	0.5 to 1.5	2 to 5

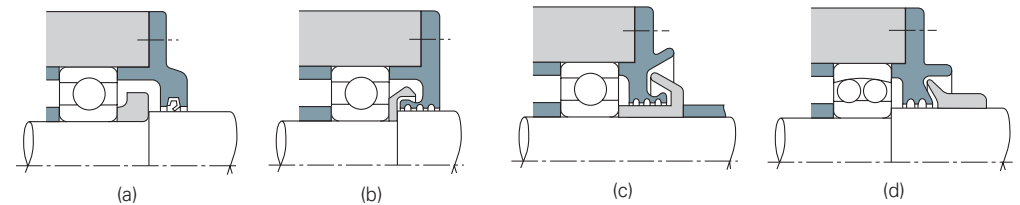

Fig. 13.6 Example Flinger Configurations

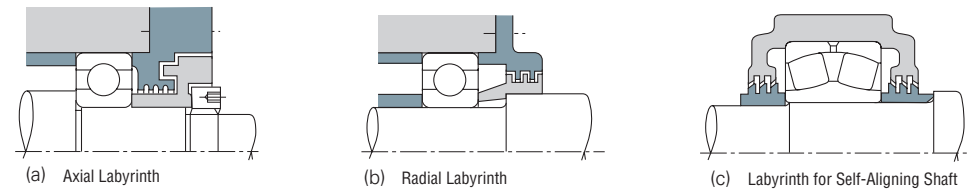

Fig. 13.7 Example Labyrinth Designs

13.3.2 Contact Seals

Contact seals function by physical contact between the shaft and seal, which may be made of synthetic rubber, synthetic resin, felt, etc. Oil seals with synthetic rubber lips are most frequently used.

(1) Oil Seals

Many types of oil seals are used to prevent lubricant from leaking while also preventing dust, water, and other foreign matter from entry (Figs. 13.8 and 13.9). In Japan, such oil seals are standardized (refer to JIS B 2402) by size and type. Since many oil seals are equipped with circumferential springs to maintain adequate contact force, oil seals can follow the non-uniform rotational movement of a shaft to some degree. Synthetic rubber seal lip materials are often used, including nitrile, acrylate, silicone, fluorine, and tetrafluoride ethylene. The maximum allowable operating temperature for each material increases in this same order. Synthetic rubber oil seals may cause troubles such as overheating, wear, and seizure unless there is an oil film between the seal lip and shaft. Therefore, some lubricant should be applied to the seal lip when the seals are installed. Furthermore, the lubricant inside the housing should spread slightly between the sliding

surfaces. However, please be aware that ester-based grease will cause acrylic rubber material to swell while low aniline point mineral oil, silicone-based grease, and silicon-based oil will cause silicone-based material to swell. Moreover, urea-based grease will cause fluorine-based material to deteriorate. The permissible circumferential speed for oil seals varies depending on type, finish of the shaft surface, liquid to be sealed, temperature, shaft eccentricity, etc. The temperature range for oil seals is restricted by the lip material. Approximate circumferential surface speeds and permitted temperatures under favorable conditions are listed in Table 13.6. When oil seals are used at high circumferential surface speed or under high internal pressure, the contact surface of the shaft must be smoothly finished, and shaft eccentricity should be under 0.02 to 0.05 mm. The hardness of the shaft's contact surface should be over HRC40 by heat treatment or hard-chrome plating in order to gain abrasion resistance. If possible, a hardness over HRC 55 is recommended. The approximate level of contact surface finish required for several shaft circumferential surface speeds is given in Table 13.7.

(2) Felt Seals

Felt seals are one of the simplest and most common seals used in transmission shafts and other applications. However, since oil permeation and leakage are unavoidable if oil is used, this type of seal is used

only for grease lubrication, primarily to prevent dust and other foreign matter from entry. Felt seals are not suitable for circumferential surface speeds exceeding 4m/sec; therefore, they should be replaced with synthetic rubber seals if the application allows.

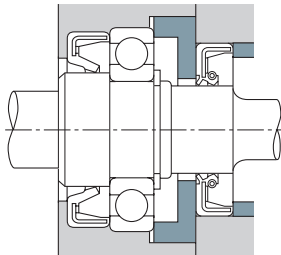

Fig. 13.8 Example of Application of Oil Seal (1)

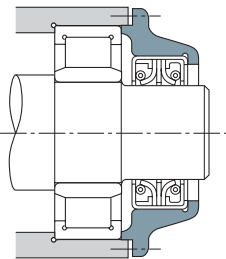

Fig. 13.9 Example of Application of Oil Seal (2)

Table 13.6 Permissible Circumferential Surface Speeds and Temperature Ranges for Oil Seals

Seal Materials		Permissible Circumferential Speeds(m/sec)	Operating Temperature Range(°C) (1)
Synthetic Rubber	Nitrile Rubber	Under 16	-25 to +100
	Acrylic Rubber	Under 25	-15 to +130
	Silicone Rubber	Under 32	-70 to +200
	Fluorine-contains Rubber	Under 32	-30 to +200
Tetrafluoride Ethylene Resin		Under 15	-50 to +220

Note (1) The upper limit of the temperature range may be raised about 20 °C for operation at short intervals.

Table 13.7 Shaft Circumferential Surface Speeds and Finish of Contact Surfaces

Circumferential Surface Speeds(m/s)	Surface Finish R _a (μm)
Under 5	0.8
5 to 10	0.4
Over 10	0.2

BEARING HANDLING AND MAINTENANCE

Part B

BEARING HANDLING AND MAINTENANCE

1. BEARING HANDLING B 005
2. BEARING DAMAGE AND
COUNTERMEASURES (Bearing Doctor) B 021



1. BEARING HANDLING

1.1	Precautions for Proper Handling of Bearings	B 006
1.2	Bearing Storage	B 006
1.2.1	Bearing Storage Location	B 006
1.2.2	How to Store Bearings	B 006
1.3	Mounting	B 006
1.3.1	Mounting of Bearings With Cylindrical Bores	B 006
1.3.2	Mounting of Bearings With Tapered Bores	B 008
1.4	Operation Inspection	B 008
1.5	Dismounting	B 011
1.5.1	Dismounting of Outer Rings	B 011
1.5.2	Dismounting of Bearings With Cylindrical Bores	B 011
1.5.3	Dismounting of Bearings With Tapered Bores	B 012
1.6	Inspection of Bearings	B 013
1.6.1	Bearing Cleaning	B 013
1.6.2	Inspection and Evaluation of Bearings	B 013
1.7	Checking the Shaft and Housing	B 014
1.7.1	Checking the Shaft	B 014
1.7.2	Checking the Housing	B 016
1.8	Maintenance and Inspection	B 017
1.8.1	Detecting and Correcting Irregularities	B 017
1.8.2	Diagnosis With Sound and Vibration	B 018



1. BEARING HANDLING

1.1 Precautions for Proper Handling of Bearings

Since rolling bearings are high-precision machine parts, they must be handled accordingly. Even if high quality bearings are used, their expected performance cannot be achieved if they are not handled properly. Be sure to take the following precautions:

(1) Keep Bearings and Surrounding Area Clean

Dust, dirt, and debris, even if invisible to the naked eye, have harmful effects on bearings. Prevent the entry of foreign matter by keeping the bearings and their environment as clean as possible.

(2) Handle Carefully

Heavy shocks during handling may cause bearings to be scratched or otherwise damaged, possibly resulting in their failure. Excessively strong impacts may cause brinelling, breaking, or cracking.

(3) Use Proper Tools

Always use proper and well-maintained equipment when handling bearings and avoid general-purpose tools.

(4) Prevent Corrosion

Since perspiration on the hands and various other contaminants may cause corrosion, keep hands clean when handling bearings and wear gloves if possible. Monitor for rust caused by corrosive gases or moisture.

1.2 Bearing Storage

To prevent rusting, each bearing is treated and packed with an anticorrosive agent, but the effectiveness of this varies greatly depending on the storage environment. Keep bearings in-box until needed and select a suitable place to store replacement bearings.

1.2.1 Bearing Storage Location

Bearings must be stored indoors in a place that is not exposed to wind or rain. In addition, an indoor environment where temperature and/or humidity is high is unsuitable for storage because such places deteriorate the anticorrosive. Be sure to store the bearings in a place where variation in environmental temperature is small.

1.2.2 How to Store Bearings

After considering the size and weight of the bearings to be stocked, secure enough space and proper carrying equipment to transport bearings safely. Proper storage shelves are recommended, with the lowest tray of the shelf at least 30 cm above the floor. Avoid putting bearings directly on the floor. The effectiveness of the anticorrosive varies depending on the storage environment, but it is generally effective for about one to three years. If storing the bearing for a longer

time, a special storage method must be used, such as immersing the bearing in turbine oil.

1.3 Mounting

The method of mounting strongly affects bearing accuracy, life, and performance. Bearing characteristics should first be thoroughly studied before mounting. Handling procedures for bearings should be fully investigated by design engineers and standards should be established regarding the following:

- (1) Cleaning of bearings and related parts
- (2) Confirmation of dimensions and finish of related parts
- (3) Mounting
- (4) Inspection after mounting
- (5) Supply of lubricants

Bearings should not be unpacked until immediately before mounting. When using grease lubrication, grease should be packed in the bearings without cleaning them first. Even when using oil lubrication, cleaning the bearings is not required. However, bearings for instruments or for high-speed operation must first be cleaned with clean filtered oil in order to remove the anti-corrosion agent. After the bearings are cleaned with filtered oil, they should be protected to prevent corrosion.

Prelubricated bearings must be used without cleaning. Bearing mounting methods depend on the bearing type and type of fit. As bearings are usually used on rotating shafts, the inner rings often require a tight fit. Bearings with cylindrical bores are usually mounted by pressing them onto shafts (press fit) or by first heating them to expand their diameter before they cool and shrink on a shaft (shrink fit). Bearings with tapered bores can be mounted directly on tapered shafts or on cylindrical shafts with tapered sleeves.

Bearings are usually mounted in housings with a loose fit. However, in cases where the outer ring has an interference fit, a press may be used. Bearings can be interference-fitted by cooling them with dry ice before mounting. In this case, a rust preventive treatment must be applied to the bearing because moisture in the air will condense on the bearing surface.

1.3.1 Mounting of Bearings With Cylindrical Bores

(1) Press Fits

Press fitting is widely used for small bearings. A mounting tool is placed on the inner ring as shown in Fig. 1.1 and the bearing is slowly pressed onto the shaft until the side of the inner ring rests against the shoulder of the shaft. The mounting tool must not be placed on the outer ring during press mounting since the bearing may be damaged. Before mounting, applying oil to the fitted shaft surface is recommended for smooth insertion. Mounting using a hammer should only be performed for small ball bearings with minimally tight fits when a press is not available. This

method should not be used for tight interference fits or for medium- or large-size bearings. Any time a hammer is used, a mounting tool must be placed on the inner ring.

When both the inner and outer rings of non-separable bearings, such as deep groove ball bearings, require a tight fit, a mounting tool is placed on both rings as shown in Fig. 1.2 and both rings are fitted at the same time using a screw or hydraulic press. A mounting

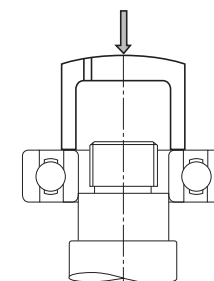

Fig. 1.1 Press Fitting Inner Ring

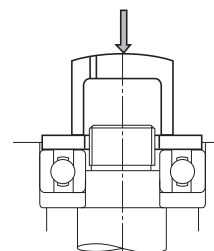

Fig. 1.2 Simultaneous Press Fitting of Inner and Outer Rings

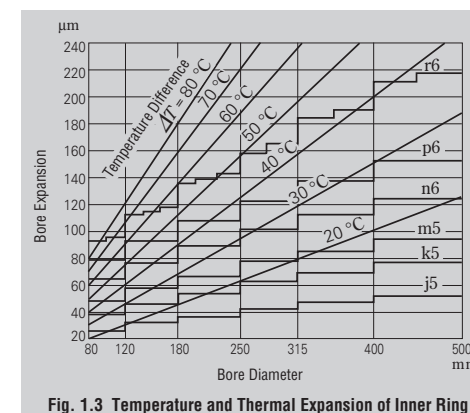

Fig. 1.3 Temperature and Thermal Expansion of Inner Ring

tool, such as shown in Fig. 1.2, should always be used for mounting self-aligning ball bearings since the outer ring may deflect.

For separable bearings, such as cylindrical roller bearings and tapered roller bearings, the inner and outer rings may be mounted separately. Assembly of the inner and outer rings, which were previously mounted separately, should be done carefully to align the inner and outer rings correctly. Careless or forced assembly may cause scratches on rolling contact surfaces.

(2) Shrink Fits

Since press fitting large bearings requires considerable force, shrink fits are widely used. The bearings are first heated to expand them before mounting.

This method prevents excessive force from being imposed on the bearings and allows for mounting in a short time.

The expansion of the inner ring under various temperature differences and bearing sizes is shown in Fig. 1.3.

Note the following when performing shrink fits:

- (a) Do not heat bearings above 120°C.
- (b) Put the bearings on a wire net or suspend them in an oil tank to prevent them from touching the tank's bottom directly.
- (c) Heat the bearings to a temperature 20 to 30 °C higher than the lowest temperature required for mounting without interference since the inner ring will cool slightly during mounting.
- (d) After mounting, the bearings will shrink in the axial and radial directions while cooling. Therefore, press the bearing firmly against the shaft shoulder using locating methods to avoid a clearance between the bearing and shoulder.

NSK Bearing Induction Heaters

NSK Bearing Heaters, which use electromagnetic induction to heat bearings, are widely used as an alternative to heating in oil.

In NSK Bearing Heaters, electricity (AC) in a coil produces a magnetic field that induces a current inside the bearing that generates heat without using flames or oil. Consequently, uniform heating in a short time is possible, making shrink fitting efficient and clean.

NSK induction heating equipment is useful when relatively frequent mounting and dismounting is necessary, such as with cylindrical roller bearings for roll necks of rolling mills and for railway journal boxes. See Page B11 for more information on dismounting.

1.3.2 Mounting of Bearings with Tapered Bores

Bearings with tapered bores are mounted on tapered shafts directly or on cylindrical shafts with adapters or withdrawal sleeves (Figs. 1.4 and 1.5). Large spherical roller bearings are often mounted using hydraulic pressure. Fig. 1.6 shows a bearing mounting utilizing a sleeve and hydraulic nut. Fig. 1.7 shows a mounting method where holes drilled in the sleeve are used to feed oil under pressure to the bearing seat. As the bearing expands radially, the sleeve is inserted axially with adjusting bolts.

Spherical roller bearings should be mounted while checking their radial internal clearance reduction and referring to the drive-up distances listed in Table 1.1. The radial clearance must be measured using clearance gauges.

In this measurement, as shown in Fig. 1.8, the clearance for both rows of rollers must be measured simultaneously, and these two values should be kept roughly the same by adjusting the relative position of the outer and inner rings.

When a large bearing is mounted on a shaft, the outer ring may be deformed into an oval shape by its own weight. If the clearance is measured at the lowest part of the deformed bearing, the measured value may be larger than the true value. If an incorrect radial internal clearance is obtained in this manner and the values in Table 1.1 are used, then the interference fit may

become too tight and the true residual clearance may become too small. In this case, as shown in Fig. 1.9, one half of the total clearance at points *a*, *b*, and *c* may be used as the residual clearance. For reference, points *a* and *b* are located on a horizontal line that passes through the bearing center while *c* is located at the lowest position of the bearing. When a self-aligning ball bearing is mounted on a shaft with an adapter, be sure that the residual clearance does not become too small. Allow for sufficient clearance for easy alignment of the outer ring.

1.4 Operation Inspection

After mounting has been completed, a running test should be conducted to determine if the bearing has been mounted correctly. Small machines may be manually operated to ensure that they rotate smoothly. Check for sticking due to foreign matter or visible flaws; uneven torque caused by improper mounting or an improper mounting surface; and excessive torque caused by inadequate clearance, mounting error, or seal friction. If there are no abnormalities, powered operation may be started.

Table 1.1 Mounting of Spherical Roller Bearings With Tapered Bores

Units : mm

Bearing Bore Diameter <i>d</i>		Reduction in Radial Clearance		Axial Drive-Up Distance				Minimum Permissible Residual Clearance	
over	incl.	min.	max.	Taper 1 : 12		Taper 1 : 30		CN	C3
				min.	max.	min.	max.		
30	40	0.025	0.030	0.40	0.45	—	—	0.010	0.025
40	50	0.030	0.035	0.45	0.55	—	—	0.015	0.030
50	65	0.030	0.035	0.45	0.55	—	—	0.025	0.035
65	80	0.040	0.045	0.60	0.70	—	—	0.030	0.040
80	100	0.045	0.055	0.70	0.85	1.75	2.15	0.035	0.050
100	120	0.050	0.060	0.75	0.90	1.9	2.25	0.045	0.065
120	140	0.060	0.070	0.90	1.10	2.25	2.75	0.055	0.080
140	160	0.065	0.080	1.0	1.3	2.5	3.25	0.060	0.100
160	180	0.070	0.090	1.1	1.4	2.75	3.5	0.070	0.110
180	200	0.080	0.100	1.3	1.6	3.25	4.0	0.070	0.110
200	225	0.090	0.110	1.4	1.7	3.5	4.25	0.080	0.130
225	250	0.100	0.120	1.6	1.9	4	4.75	0.090	0.140
250	280	0.110	0.140	1.7	2.2	4.25	5.5	0.100	0.150
280	315	0.120	0.150	1.9	2.4	4.75	6.0	0.110	0.160
315	355	0.140	0.170	2.2	2.7	5.5	6.75	0.120	0.180
355	400	0.150	0.190	2.4	3.0	6	7.5	0.130	0.200
400	450	0.170	0.210	2.7	3.3	6.75	8.25	0.140	0.220
450	500	0.190	0.240	3.0	3.7	7.5	9.25	0.160	0.240
500	560	0.210	0.270	3.4	4.3	8.5	11.0	0.170	0.270
560	630	0.230	0.300	3.7	4.8	9.25	12.0	0.200	0.310
630	710	0.260	0.330	4.2	5.3	10.5	13.0	0.220	0.330
710	800	0.280	0.370	4.5	5.9	11.5	15.0	0.240	0.390
800	900	0.310	0.410	5.0	6.6	12.5	16.5	0.280	0.430
900	1 000	0.340	0.460	5.5	7.4	14.0	18.5	0.310	0.470
1 000	1 120	0.370	0.500	5.9	8.0	15.0	20.0	0.360	0.530

Remark The values for reduction in radial internal clearance are for bearings with CN clearance. For bearings with C3 clearance, the maximum values listed should be used for the reduction in radial internal clearance.

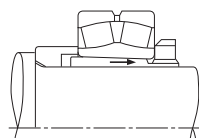

Fig. 1.4 Mounting With Adapter

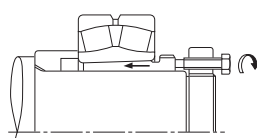

Fig. 1.5 Mounting With Withdrawal Sleeve

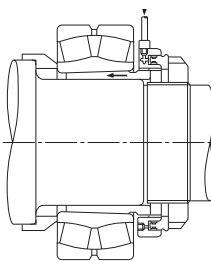

Fig. 1.6 Mounting With Hydraulic Nut

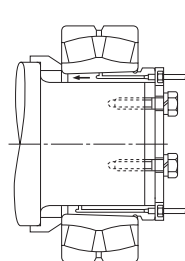

Fig. 1.7 Mounting With Special Sleeve and Hydraulic Pressure

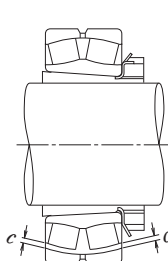

Fig. 1.8 Clearance Measurement of a Spherical Roller Bearing

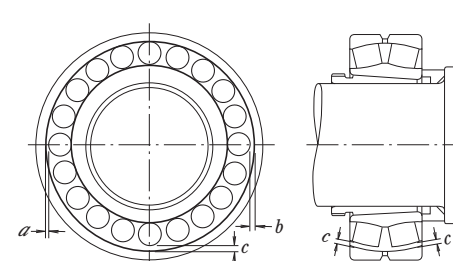

Fig. 1.9 Measuring Clearance in Large Spherical Roller Bearing

After a pre-operation examination, large machines that cannot be turned by hand should be started with no load. After the machine starts, immediately cut off the power and allow the machine to coast to a stop. Confirm that there are no abnormalities such as vibration, noise, contact with the rotating parts, or similar. Powered operation should be started slowly without load and observed carefully until it is determined that no abnormalities exist. Then, gradually increase the speed, load, and other conditions to their normal levels. Be sure to monitor for abnormal noise, excessive rise of bearing temperature, leakage and contamination of lubricants, etc. If any abnormality is found, stop the test immediately and inspect the machine. If possible, the bearing should be dismounted for examination.

Although bearing temperature can generally be estimated by the temperature of the outside surface of the housing, it is better to directly measure the temperature of the outer ring through oil holes. The bearing temperature should rise gradually to a steady state within one to two hours after operation starts. If the wrong bearing or mounting is used, bearing temperature may increase rapidly and become abnormally high. The cause of this abnormal temperature may be excessive lubricant, insufficient bearing clearance, incorrect mounting, or excessive friction of the seals.

In high-speed operation, an incorrect selection of bearing type or lubricating method may also cause abnormal temperature rise.

The sound of a bearing may be checked with a noise locator or vibration monitoring equipment. Abnormal conditions may be indicated by a loud metallic sound or other irregular noise. Possible causes include incorrect lubrication, poor alignment of the shaft and housing, or the entry of foreign matter into the bearing. Details and countermeasures for various irregularities are listed in Table 1.2.

Table 1.2 Causes of and Countermeasures for Operating Irregularities

Irregularities		Possible Causes	Countermeasures
Noise	Loud Metallic Sound ⁽¹⁾	Abnormal load	Improve the fit, internal clearance, preload, and/or position of housing shoulder.
		Incorrect mounting	Improve the machining accuracy and alignment of the shaft and housing, improve the accuracy of the mounting, or change the mounting method
		Insufficient or improper lubricant	Replenish the lubricant or select another lubricant.
		Contact of rotating parts	Modify the seal (labyrinth, etc.).
	Rhythmic Sound	Flaws, corrosion, or scratches on raceways	Clean or replace the bearing, improve the seals, and use clean lubricant.
		Brinelling	Replace the bearing and use care when handling bearings.
Irregular Sound	Flaking on raceway	Replace the bearing.	
	Excessive clearance	Improve the fit, clearance and preload.	
	Entry of foreign particles	Clean or replace the bearing, improve the seals, and use clean lubricant.	
Abnormal Temperature Rise	Flaws or flaking on balls	Replace the bearing.	
	Excessive lubricant	Reduce the amount of lubricant and/or select a stiffer grease.	
	Insufficient or improper lubricant	Replenish lubricant or select another appropriate lubricant.	
	Abnormal load	Improve the fit, internal clearance, preload, and/or position of housing shoulder.	
	Incorrect mounting	Improve the machining accuracy and alignment of the shaft and housing, improve the accuracy of the mounting, or change the mounting method.	
Vibration (Runout)	Creep on fitted surface, excessive seal friction	Replace the bearing, change the seal type, and correct the shaft and housing to consider the fit.	
	Brinelling	Replace the bearing and use care when handling bearings.	
	Flaking	Replace the bearing.	
	Incorrect mounting	Correct the squareness between the shaft and housing shoulder or side of spacer.	
Leakage or Discoloration of Lubricant	Entry of foreign particles	Clean or replace the bearing, improve the seals.	
	Too much lubricant, entry of foreign matter or abrasion chips	Replace the bearing or lubricant, reduce the amount of lubricant, select a stiffer grease, and clean the housing and adjacent parts.	

Note ⁽¹⁾ Intermittent squealing or high-pitched noise may be heard in medium- to large-sized cylindrical roller bearings or ball bearings operating under grease lubrication in low-temperature environments. Under such low-temperature conditions, bearing temperature will not rise, and fatigue life and grease performance are not affected. Although intermittent squealing or high-pitched noises may occur under these conditions, the bearing is fully functional and can continue to be used. If greater noise reduction or quieter operation properties are needed, please contact your nearest NSK branch office.

1.5 Dismounting

A bearing may be removed for periodic inspection or for other reasons. If the removed bearing is to be used again or is removed only for inspection, it should be dismantled as carefully as when it was mounted. If the bearing has a tight fit, removal may be difficult. The means for removal should be considered in the original design of the adjacent parts of the machine. When dismantling, the procedure and sequence of removal should first be studied using the machine plan and while considering the type of mounting fit in order to perform the operation properly.

1.5.1 Dismounting of Outer Rings

In order to remove an outer ring that is tightly fitted into a housing with push-out holes, first place bolts in the push-out holes at several locations along the circumference as shown in Fig. 1.10, and remove the outer ring by uniformly tightening the bolts. These bolt holes should always be fitted with blank plugs when not being used for dismantling. For separable bearings, such as tapered roller bearings, some notches should be made at several positions in the housing shoulder, as shown in Fig. 1.11, so that the outer ring may be pressed out with a dismantling tool or by tapping.

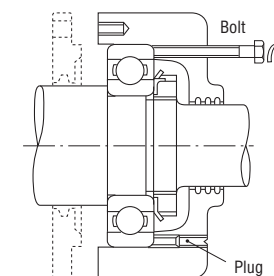

Fig. 1.10 Removal of Outer Ring With Dismounting Bolts

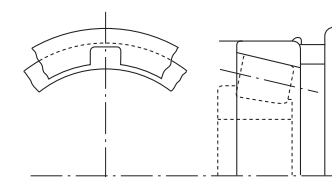

Fig. 1.11 Removal Notches

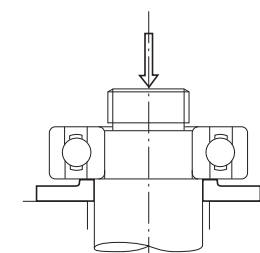

Fig. 1.12 Removal of Inner Ring Using a Press

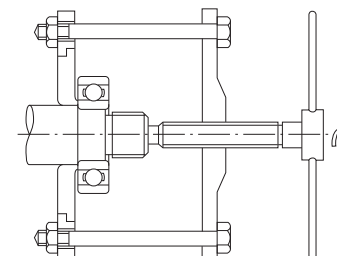

Fig. 1.13 Removal of Inner Ring Using a Withdrawal Tool (1)

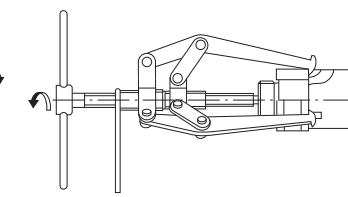

Fig. 1.14 Removal of Inner Ring Using a Withdrawal Tool (2)

In both cases, the claws of the tools must substantially engage the face of the inner ring; therefore, consider the size of the shaft shoulder during design or cut grooves in the shoulder to accommodate the withdrawal tools (Fig. 1.14).

The oil-injection method is usually used for the dismantling of large bearings. Oil pressure is applied through holes in the shaft and allows for easy dismantling. For extra wide bearings, the oil-injection method is used together with a withdrawal tool. Induction heating is used to remove the inner rings of NU- and NJ-type cylindrical roller bearings. The inner rings are expanded by brief local heating, and then removed (Fig. 1.15). Induction heating is also used to mount several bearings of these types on a shaft.

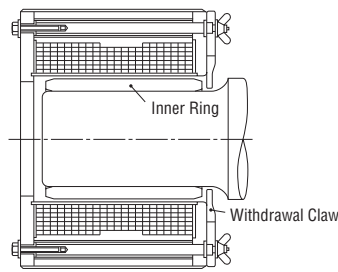

Fig. 1.15 Removal of Inner Ring Using an Induction Heater

1.5.3 Dismounting of Bearings With Tapered Bores

When dismantling relatively small bearings with adapters, the inner ring is held by a stop fastened to the shaft and the nut is loosened several turns. As shown in Fig. 1.18, this is followed by hammering on the sleeve using a suitable tool. Fig. 1.16 shows one procedure for dismantling a withdrawal sleeve by tightening the removal nut. If this procedure is difficult, it may be possible to drill and tap bolt holes in the nut and remove the sleeve by tightening the bolts as shown in Fig. 1.17.

Large bearings may be removed easily using oil pressure. Fig. 1.19 illustrates the removal of a bearing by forcing oil under pressure through a hole and groove in a tapered shaft to expand the inner ring. The bearing may suddenly move axially when the interference is relieved during this procedure so a stop nut is recommended for protection. Fig. 1.20 shows a removal using a hydraulic nut.

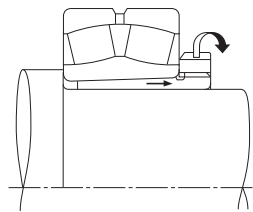

Fig. 1.16 Removal of Withdrawal Sleeve Using a Withdrawal Nut (1)

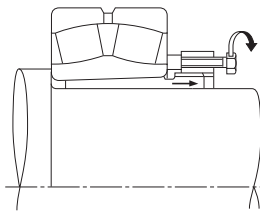

Fig. 1.17 Removal of Withdrawal Sleeve Using a Withdrawal Nut (2)

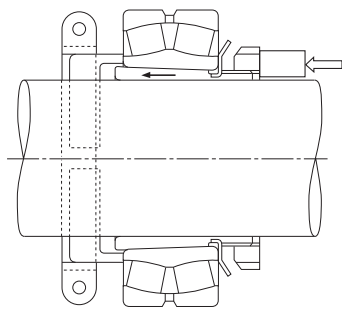

Fig. 1.18 Removal of Adapter With a Stop and Axial Pressure

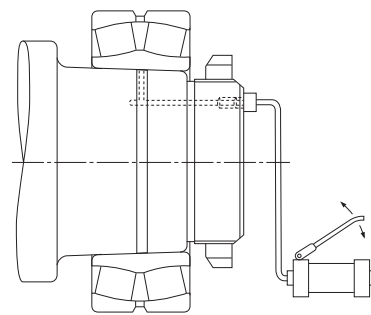

Fig. 1.19 Removal Using an Oil Injection Hydraulic Pump

1.6 Inspection of Bearings

1.6.1 Bearing Cleaning

When bearings are inspected, first record the appearance of the bearings and check the amount and condition of the residual lubricant. After the lubricant has been sampled, the bearings should be cleaned. In general, light oil or kerosene may be used as a cleaning solution.

Dismounted bearings should first be given a preliminary cleaning followed by a finishing rinse. Each bath should have a metal net to submerge the bearings in oil without touching the sides or bottom of the tank. If the bearings are rotated with foreign matter in them during preliminary cleaning, the raceways may be damaged. Lubricant and other deposits should be removed in the oil bath during an initial rough cleaning with a soft brush or similar. After the bearing is relatively clean, give it a finishing rinse. The finishing rinse should be performed carefully by rotating the bearing while keeping it immersed in the rinsing oil. Always keep the rinsing oil clean.

1.6.2 Inspection and Evaluation of Bearings

After being thoroughly cleaned, examine the condition of bearing raceways and external surfaces, the amount of cage wear, the increase in internal clearance, and degradation of tolerances. Carefully check these points and examine for possible damage or other abnormalities to determine if the bearing can be reused.

For small, non-separable ball bearings, hold the bearing horizontally in one hand, and then rotate the outer ring to confirm that it turns smoothly. Separable bearings such as tapered roller bearings may be checked by individually examining their rolling elements and the outer ring raceway.

Large bearings cannot be rotated manually; however, the rolling elements, raceway surfaces, cages, and contact surface of the ribs should be carefully examined visually. The more important a bearing is, the more carefully it should be inspected.

The determination to reuse a bearing should be made only after considering the degree of bearing wear, the function of the machine, the importance of the bearing in the machine, operating conditions, and the time until the next inspection. However, if any of the following are true, reuse is not possible and replacement is necessary:

- Cracks exist in the inner or outer rings, rolling elements, or cage.
- Flaking is present on the raceway or rolling elements.
- There is significant smearing of the raceway surfaces, ribs, or rolling elements.
- The cage is significantly worn or rivets are loose.
- Rust or scoring is present on the raceway surfaces or rolling elements.
- Any significant impact or brinell traces exist on the raceway surfaces or rolling elements.
- There is significant evidence of creep on the bore or periphery of the outer ring.
- Discoloration by heat is evident.
- Significant damage to the seals or shields of grease-sealed bearings has occurred.

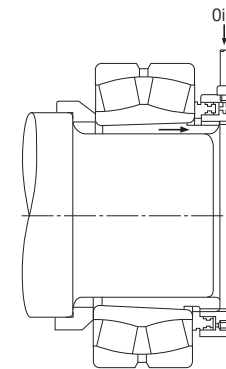

Fig. 1.20 Removal Using a Hydraulic Nut

1.7 Checking the Shaft and Housing

1.7.1 Checking the Shaft

(a) Cylindrical Shaft

- (1) Dimensional check of shaft
Use an outside micrometer to measure the shaft size at the place where the bearing will be mounted to confirm that the bearing size is correct. The measurement positions are shown in Fig. 1.21.
- (2) Check of shaft outside surface
Check the surface of shaft where the bearing will be mounted for scratches, dents, rust, or stepped wear.
 - If there are scratches or dents:
Round the edge with an oil stone and/or sandpaper to smooth the surface.

- If there is rust:
Remove rust with an oil stone and/or sandpaper to smooth the surface.
 - If there is stepped wear:
After measuring the shaft, determine if correction is possible.
- (3) Anticorrosive agent
After completing the check, apply an anticorrosive agent.

(b) Tapered Shaft

- (1) Check of shaft shape
Measure the shape of the shaft where the bearing will be mounted to confirm that it is correct. The measurement positions are shown in Fig. 1.22. Use a taper gauge (sine bar system) for measurement (Fig. 1.22).

- (2) Check of shaft outside surface
Check the shaft surface where the bearing will be mounted for scratches, dents, rust, or stepped wearing.
 - If there are scratches or dents:
Round edge with an oil stone and/or sandpaper to smooth the surface.
 - If there is rust:
Remove rust with an oil stone and/or sandpaper to smooth the surface.

- If there is stepped wear:
After measuring the shaft, determine if correction is possible.
- (3) Anticorrosive agent
After completing the check, apply an anticorrosive agent.

- Inspect the shape of the tapered section with a taper gauge. Apply a thin coat of bluing over the entire surface of taper gauge bore face, and insert the gauge slowly after matching it to the center of the tapered shaft. Move the gauge back and forth and pull it out slowly. Note the surface of the tapered shaft covered with blue dye.

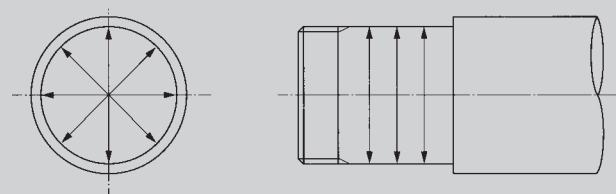

Fig. 1.21 Cylindrical Shaft

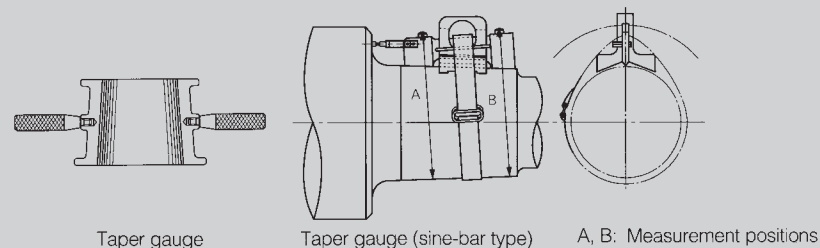

Fig. 1.22 Tapered Shaft

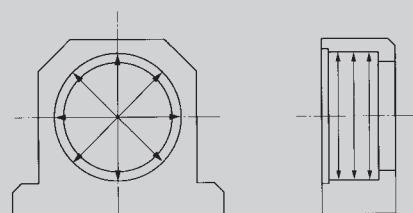
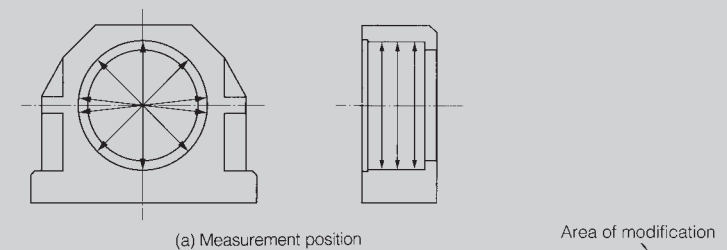
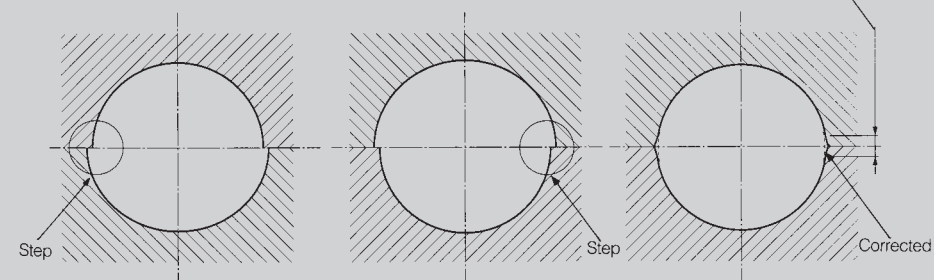

Fig. 1.23 Integrated Housing



(a) Measurement position



(b) Step at joining part

(c) Step modification at joining part

Fig. 1.24 Split Housing

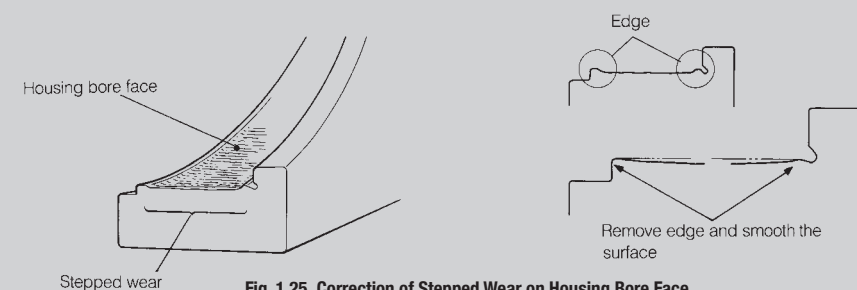

Fig. 1.25 Correction of Stepped Wear on Housing Bore Face

1.7.2 Checking the Housing

(a) Integrated Housing

- (1) Check of housing bore size
Measure the housing bore where the bearing will be mounted to confirm that the size is correct. The measurement position is shown in Fig. 1.23. Use an inside micrometer for measurement.
- (2) Check of housing bore face
Check the surface of the housing bore where the bearing will be mounted for scratches, dents, rust, or stepped wear.
 - If there are scratches or dents:
Round edges with an oil stone and/or sandpaper to smooth the surface.
 - If there is rust:
Remove rust with an oil stone and/or sandpaper to smooth the surface.
 - If there is stepped wear (Fig. 1.25):
After measuring the housing bore, decide if correction and reuse is possible. If the measured value of the housing bore is within its tolerance, use an oil stone and/or sandpaper to remove any sections with stepped wear and smooth the surface before reuse. If stepped wear is severe, either plate or apply thermal spraying to reconstitute the correct housing size before reuse.
- (3) Anticorrosive agent
After completing the check, apply an anticorrosive agent.

(b) Split Housing

- (1) Check of housing bore size
When using a split housing, correctly assemble the housing without the bearing and measure bore dimensions at the place where the bearing will be mounted to confirm that the dimensions are correct. The measurement position is shown in Fig. 1.24 (a). Use an inside micrometer for measurement.
- (2) Check of housing bore face
Check the surface of the housing bore where the bearing will be mounted for scratches, dents, rust, or stepped wear.
 - If there are scratches or dents:
Round edges with an oil stone and/or sandpaper to smooth the surface.
 - If there is rust:
Remove rust with an oil stone and/or sandpaper to smooth the surface.
 - If there is stepped wear (Fig. 1.25):
After measuring the housing bore, decide if correction is possible. If the measured value of the housing bore is within its tolerance, use an oil stone and/or sandpaper to remove any sections with stepped wear and smooth the surface before reuse.
 - If the stepped wear is severe:
Either plate or apply thermal spraying to reconstitute the correct housing size before reuse.
 - If there is a step:
Steps may occur where the split halves of the housing join. If a step is found, correct it as shown in Fig. 1.24 (c).
- (3) Anticorrosive agent
After completing the check, apply an anticorrosive agent.

1.8 Maintenance and Inspection

1.8.1 Detecting and Correcting Irregularities

In order to maintain the original performance of a bearing for as long as possible, proper maintenance and inspection must be performed. If proper procedures are used, many bearing problems can be avoided and the reliability, productivity, and operating costs of the equipment containing the bearings are all improved. Periodic maintenance should be performed following specified procedures. This periodic maintenance encompasses the supervision of operating conditions, the supply or replacement of lubricants, and regular periodic inspection. Items that should be regularly checked during operation include bearing noise, vibration, temperature, and lubrication. If an irregularity is found during operation, the cause should be determined and proper corrective actions should be taken after referring to Table 1.2. If necessary, the bearing should be dismantled and examined in detail. Refer to Section 1.6 Inspection of Bearings for dismantling and inspection procedures.

1.8.2 Diagnosis with Sound and Vibration

Classification of sounds and vibrations

Sounds and vibration accompany the rotation of rolling bearings. The tone and amplitude of such sounds and vibration vary depending on the type of bearing, mounting conditions, operational conditions, etc. The sounds and vibration of a rolling bearing can be classified under the following four chief categories and each category can be further classified into several sub-categories, as described in Table 1.3 below. However, boundaries between groups are not definite. Even if some types of sounds or vibrations are inherent in the bearings, the volume might be related to the manufacturing process. Conversely,

some types of sounds or vibrations, even if caused by manufacturing, cannot be eliminated under normal conditions.

By recording the sounds and vibrations of a rotating machine and analyzing them, the cause may be inferred. As shown by the figures on the next page, a mechanically normal bearing shows a stable waveform. However, a bearing with damage such as a scratch shows a waveform with wide swings indicating large-amplitude sounds at regular intervals (refer to Figs. 1.26 and 1.27).

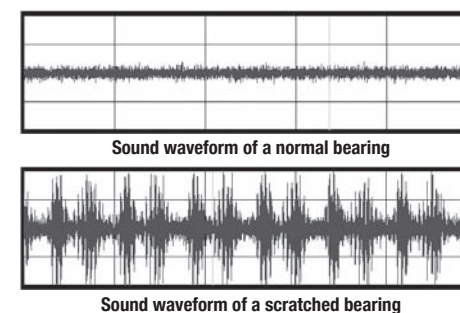

Fig. 1.26

When the inner ring raceway surface is damaged
Bore diameter: 100 mm
Recording and analysis method: Envelope analysis of sounds recorded by microphone for a test machine
Number of rotations: 50 min⁻¹

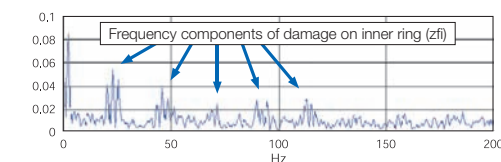

Fig. 1.27

Table 1.3 Classification of Sounds and Vibrations in a Rolling Bearing

	Sound Type		Vibration	Features	
Structural	Race noise		Free vibration of raceway ring	Continuous noise: basic unavoidable noise that all bearings generate	
	Roller/ball click noise		Free vibration of raceway ring, free vibration of cage	Regular noise at a certain interval: found in large bearings and horizontal shafts, radial loads and low rpm	
	Squeal noise		Free vibration of raceway ring	Intermittent or continuous: generally found in large cylindrical roller bearings and under radial load, grease lubrication, and particular speeds	
	Cage noise	"CK" sound		Free vibration of cage	Regular noise at a set interval: generated by all bearing types
		"CG" sound		Vibration of cage	Intermittent or continuous: lubrication with certain greases
		Tapping sound		Free vibration of cage	Set interval: slightly irregular under radial load and during initial stage
Rumbling		Vibration from passage of rolling element	Continuous: found in all bearing types under radial load		
Manufacturing	Chatter noise		Vibration due to waviness	Inner ring Continuous noise	
			Outer ring	Continuous noise	
			Rolling element	Continuous with rollers, occasional with balls	
Handling	Flaw noise		Vibration due to flaw	Inner ring Regular noise at a set interval	
			Outer ring	Regular noise at a set interval	
			Rolling element		
	Contamination noise		Vibration due to contamination	Irregular	
Other	Seal noise		Free vibration of a seal	Contact seal	
	Lubricant noise		—	Irregular	
	Rumbling		Runout	f_r	Continuous
				f_c	Continuous
				$f_r - 2f_c$	Continuous

n : Positive integer (1, 2, 3...)
 Z : Number of rolling elements
 f_{RIN} : Natural frequency of ring in radial bending mode (Hz)
 f_{AIN} : Natural frequency in the mode of angular vibration in inertia of outer ring-spring system (Hz)
 f_i : Rotation frequency of inner ring (Hz)

Generated Frequency (Frequency Analysis)			Source	Countermeasures
FFT of Original Wave		FFT After Envelope (Basic No.)		
Radial (Angular) Direction	Axial Direction			
$f_{RIN} \cdot f_{MI}$	$f_{AIN} \cdot f_{AM}$	—	Selective resonance from waviness (rolling friction)	Improve rigidity around bearings, provide appropriate radial clearance, use high-viscosity lubricant and high-quality bearings.
$f_{RIN} \cdot f_{MI}$	$f_{AIN} \cdot f_{AM}$	Zf_c	Collision of rolling elements with inner ring or cage	Reduce radial clearance, apply preload, use high-viscosity oil
($\approx f_{R2N} \cdot f_{R3N}$)	—	?	Self-induced vibration caused by sliding friction at rolling surface	Reduce radial clearance, apply preload, change grease, replace with bearings with countermeasures
Natural frequency of cage		f_c	Collision of cage with rolling elements or rings	Apply preload, use high-viscosity lubricant, reduce mounting error
Natural frequency of cage		?	Self-induced vibration caused by friction at cage guide surface	Change grease brand, replace with cage with countermeasures
Natural frequency of cage		Zf_c	Collision of cage and rolling element caused by grease resistance	Reduce radial clearance, apply preload, use low-viscosity lubricant
Zf_c	—	—	Displacement of inner ring due to rolling element passage	Reduce radial clearance, apply preload
$nZf_i \pm f_r$ ($nZ \pm 1$ peaks)	nZf_i (nZ peaks)	—	Inner ring raceway waviness, irregularity of shaft exterior	Use high-quality bearings, improve shaft accuracy
nZf_c ($nZ \pm 1$ peaks)	nZf_c (nZ peaks)	—	Outer ring raceway waviness, irregular housing bore	Use high-quality bearings, improve housing bore accuracy
$2nf_b \pm f_c$ ($2n$ peaks)	$2nf_b$ ($2n$ peaks)	—	Rolling element waviness	Use high-quality bearings
$f_{RIN} \cdot f_{MI}$	$f_{AIN} \cdot f_{AM}$	Zf_i	Nicks, dents, rust, flaking on inner ring raceway	Replace bearing and take care when handling
		Zf_c	Nicks, dents, rust, flaking on inner ring raceway	Replace bearing and take care when handling
		$2f_b$	Nicks, dents, rust, flaking on rolling elements	Replace bearing and take care when handling
$f_{RIN} \cdot f_{MI}$	$f_{AIN} \cdot f_{AM}$	Irregular	Entry of dirt and debris	Wash the bearing, improve sealing
Natural frequency of seal		(f_n)	Self-induced vibration due to friction at seal contact area	Change the seal, change the grease
?	?	Irregular	Lubricant or lubricant bubbles crushed between rolling elements and raceways	Change the grease
f_r	—	—	Irregular inner ring cross-section	Use high-quality bearings
f_c	—	—	Ball variation in bearing, rolling elements non-equidistant	Use high-quality bearings
$f_r - 2f_c$	—	—	Non-linear vibration due to rigid variation by ball variation	Use high-quality bearings

f_c : Orbital revolution frequency of rolling elements(Hz)
 f_{AIN} : Ring natural frequency in axial bending mode(Hz)
 f_{AM} : Natural frequency in the mode of axial vibration in mass of an outer ring spring system (Hz)
 f_i : $f_r - f_c$ (Hz)
 f_b : Rotation frequency of rolling element around its center(Hz)

2. BEARING DAMAGE AND COUNTERMEASURES (Bearing Doctor)

2.1 Bearing Damage B 022

2.2 Running Traces and Applied Loads B 022

2.3 Bearing Damage and Countermeasures B 024

2.3.1 Flaking (Spalling) B 025

2.3.2 Peeling B 029

2.3.3 Scoring B 030

2.3.4 Smearing B 032

2.3.5 Fracture B 034

2.3.6 Cracks B 035

2.3.7 Cage Damage B 037

2.3.8 Denting B 039

2.3.9 Pitting B 040

2.3.10 Wear B 041

2.3.11 Fretting B 043

2.3.12 False Brinelling B 044

2.3.13 Seizure B 045

2.3.14 Creep B 047

2.3.15 Electrical Corrosion B 048

2.3.16 Rust and Corrosion B 049

2.3.17 Mounting Flaws B 050

2.3.18 Discoloration B 051

Appendix Bearing Diagnostic Chart B 052



2. BEARING DAMAGE AND COUNTERMEASURES (Bearing Doctor)

2.1 Bearing Damage

In general, if rolling bearings are used correctly they will survive to their predicted fatigue life. However, they often fail prematurely due to avoidable mistakes. In contrast to fatigue life, this premature failure can be caused by improper mounting, improper handling, improper or insufficient lubrication, entry of foreign matter, or abnormal heat generation.

For instance, the causes of rib scoring may include insufficient lubrication, use of improper lubricant, a faulty lubrication system, entry of foreign matter, bearing mounting error, excessive deflection of the shaft, or any combination of these. Thus, it is difficult to determine the real cause of some premature failures.

If all the conditions at the time of failure and before the failure are known, including the application, operating conditions, and environment, then, by studying the nature of the failure and its probable causes, the possibility of similar future failures can be reduced.

2.2 Running Traces and Applied Loads

As the bearing rotates, the raceways of the inner ring and outer ring contact the rolling elements. This results in a wear trace on both the rolling elements and raceways. Running traces are useful because they indicate load conditions; they should be carefully checked when the bearing is disassembled.

If running traces are clearly defined, it is possible to determine whether the bearing was carrying a radial load, axial load, or moment load. Furthermore, the roundness of the bearing can be determined. Check whether unexpected bearing loads or large mounting errors occurred, and determine the probable cause of the bearing damage.

Fig. 2.2 shows running traces generated in deep groove bearings under various load conditions. Fig. 2.2 (a) shows the most common running trace generated when the inner ring rotates under a radial load only. Figs. 2.2 (e) through (h) show several different running traces that reflect a shortened life due to adverse effects on the bearings.

Similarly, Fig. 2.2 shows different roller bearing running traces. Fig. 2.2 (i) shows an outer ring running trace when a radial load is properly applied to a cylindrical roller bearing with a load on a rotating inner ring. Fig. 2.2 (j) shows a running trace resulting from shaft bending or relative inclination between

the inner and outer rings. This misalignment leads to the generation of slightly shaded (dull) bands in the width direction. Traces are diagonal at the beginning and end of the loading zone. Fig. 2.2 (k) shows the running trace on the outer ring under radial load for double-row tapered roller bearings where a single load is applied to the rotating inner ring while Fig. 2.2 (l) shows the running trace on the outer ring under axial load. When misalignment exists between the inner and the outer rings, the application of a radial load causes running traces to appear on the outer ring as shown in Fig. 2.2 (m).

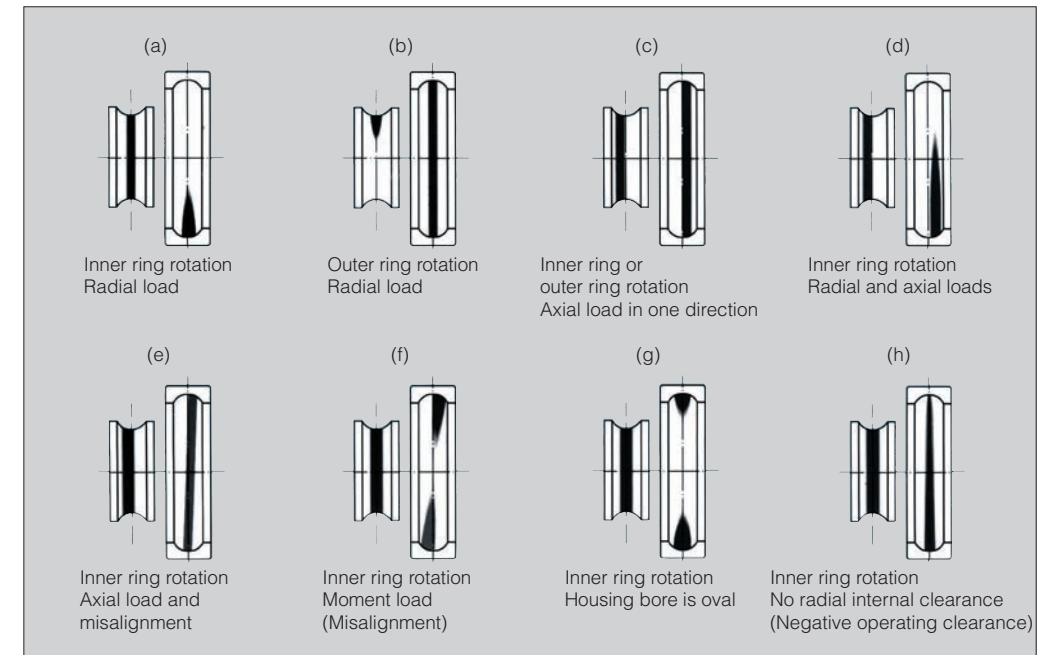

Fig. 2.2 Typical Running Traces of Deep Groove Ball Bearings

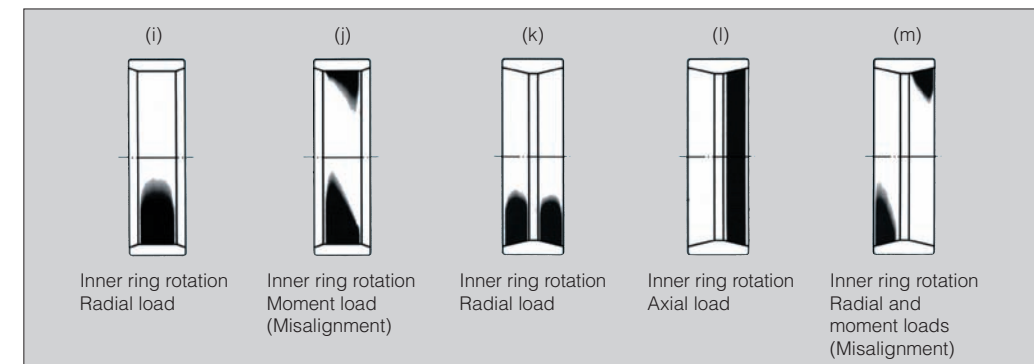

Fig. 2.2 Typical Running Traces of Roller Bearings

2.3 Bearing Damage and Countermeasures

Sections 2.3.1 through 2.3.18 show various types of bearing damage and countermeasures. Please consult these sections when trying to determine the cause of bearing damage. The bearing diagnostic chart in the Appendix on Page B46 may be useful as a quick reference guide.

2.3.1 Flaking (Spalling)

Damage	Possible Causes	Countermeasures
Small pieces of bearing material split off from the smooth surface of the raceway or rolling elements due to rolling fatigue and create regions with a rough and coarse texture.	<ul style="list-style-type: none"> • Excessive load • Poor mounting (misalignment) • Moment load • Entry of foreign debris or water • Poor lubrication, improper lubricant • Unsuitable bearing clearance • Improper precision of shaft or housing, unevenness in housing rigidity, large shaft bending • Rust, corrosion pits, smearing, dents (Brinelling) 	<ul style="list-style-type: none"> ➢ Reconfirm the bearing application and check load conditions ➢ Improve the mounting method ➢ Improve the sealing mechanism, prevent rusting during idle periods ➢ Use a lubricant with the proper viscosity, improve the lubrication method ➢ Check the precision of the shaft and housing ➢ Check the bearing internal clearance



Photo 1-1

Part: Inner ring of an angular contact ball bearing
Symptom: Flaking around half of the circumference of the raceway surface
Cause: Poor lubrication due to entry of cutting coolant into bearing



Photo 1-2

Part: Inner ring of an angular contact ball bearing
Symptom: Flaking diagonally along raceway
Cause: Poor alignment between shaft and housing during mounting



Photo 1-3

Part: Outer ring of Photo 1-4
Symptom: Flaking of raceway surface at ball pitch
Cause: Dents due to shock load while stationary



Photo 1-4

Part: Balls of Photo 1-3
Symptom: Flaking of ball surface
Cause: Dents due to shock load while stationary



Photo 1-5
Part: Inner ring of a spherical roller bearing
Symptom: Flaking of only one raceway over its entire circumference
Cause: Excessive axial load

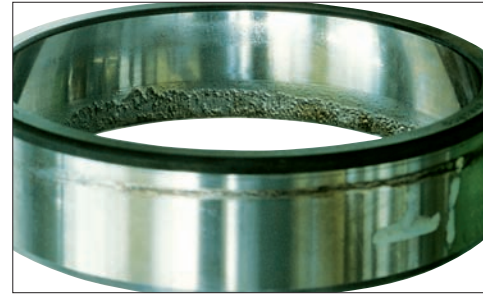

Photo 1-6
Part: Outer ring of Photo 1-5
Symptom: Flaking of only one raceway over its entire circumference
Cause: Excessive axial load

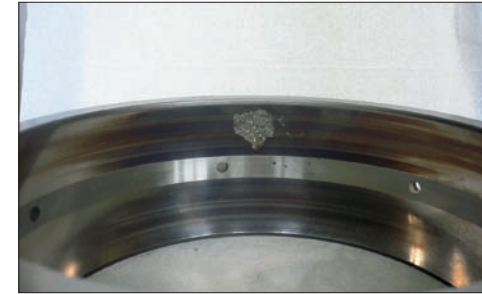

Photo 1-11
Part: Outer ring of a spherical roller bearing
Symptom: Discoloration and flaking on outer ring raceway surface
Cause: Poor lubrication under high temperatures

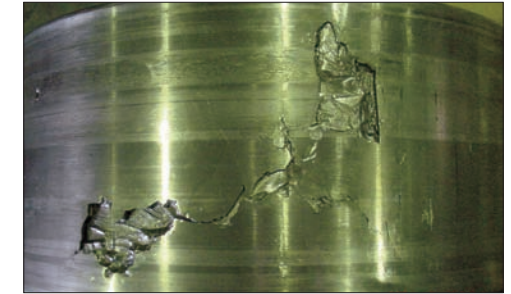

Photo 1-12
Part: Outer ring of a cylindrical roller bearing for Sendzimir mills
Symptom: Flaking of outside surface
Cause: Progression of fatigue in outer ring material (Prolonged grinding on outer ring outside surface)



Photo 1-7
Part: Inner ring of a spherical roller bearing
Symptom: Flaking of only one raceway
Cause: Poor lubrication



Photo 1-8
Part: Rollers of a cylindrical roller bearing
Symptom: Premature flaking of rolling surfaces axially
Cause: Scratches caused during improper mounting



Photo 1-13
Part: Inner ring of a cylindrical roller bearing for Sendzimir mills
Symptom: Flaking of the raceway surface
Cause: Severe operating conditions and low-viscosity oil lubrication

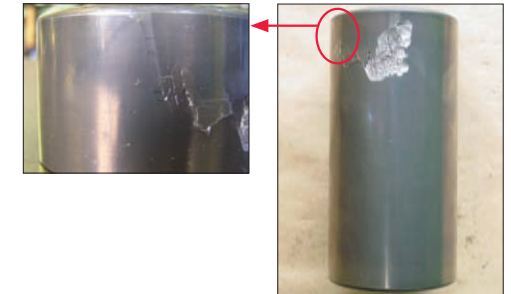

Photo 1-14
Part: Roller of a cylindrical roller bearing
Symptom: Flaking of rolling surfaces
Cause: Progression from a flaw or crack in roller during mounting

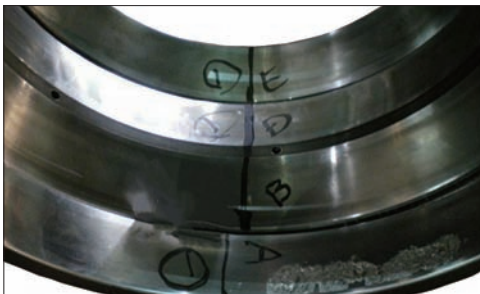

Photo 1-9
Part: Outer ring of a four-row tapered roller bearing
Symptom: Flaking of raceway (loading area)
Cause: Excessive moment load



Photo 1-10
Part: Enlargement of raceway surface in Photo 1-9
Symptom: Flaking of one side of the raceway
Cause: Excessive pressure due to misalignment



Photo 1-15
Part: Inner ring of deep groove ball bearing
Symptom: Flaking of raceway at ball pitch
Cause: Dents due to shock load during mounting



Photo 1-16
Part: Inner ring of an angular contact ball bearing
Symptom: Flaking of raceway at ball pitch
Cause: Dents due to shock load while stationary

Example 1. Combined Flaking Damage

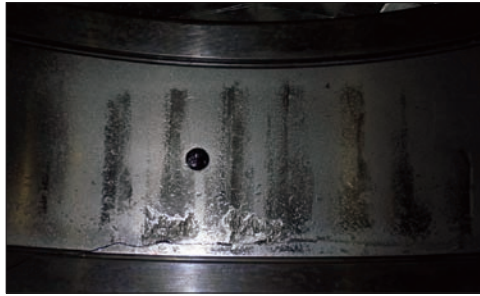

Photo 1-15

Part: Outer ring of a cylindrical roller bearing
Symptom: Rust, flaking, and crack on raceway surface
Cause: Rust at the pitch interval led to flaking during operation. Further operation resulted in cracking.

Example 2. Combined Flaking Damage



Photo 1-16

Part: Outer ring of a spherical roller bearing
Symptom: Flaking, cracking, and wear combined on the outer ring raceway
Cause: Wear in two places due to poor lubrication (primary damage) progressed to flaking in one spot (secondary damage) that later became a crack (tertiary damage).

2.3.2 Peeling

Damage	Possible Causes	Countermeasures
Dull or cloudy spots appear on the bearing surface along with light wear. Tiny cracks are generated from these dull spots downward to a depth of 5 to 10 μm . Small particles fall off and extensive minor flaking occurs.	<ul style="list-style-type: none"> • Unsuitable lubricant • Entry of debris into lubricant • Rough surface due to poor lubrication • Surface roughness of mating parts 	<ul style="list-style-type: none"> ➢ Select a different lubricant ➢ Improve the sealing mechanism ➢ Improve the surface finish of the mating parts

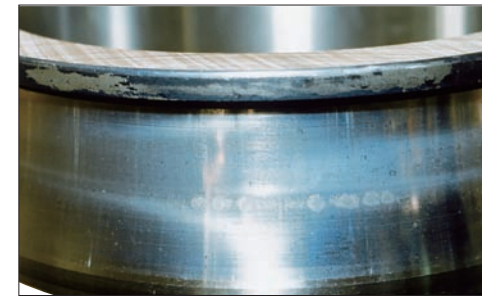

Photo 2-1

Part: Inner ring of a spherical roller bearing
Symptom: Round peeling on the center of the raceway surface
Cause: Poor lubrication



Photo 2-2

Part: Enlargement of pattern in Photo 2-1



Photo 2-3

Part: Convex rollers from Photo 2-1
Symptom: Round peeling on the center of the rolling surfaces
Cause: Poor lubrication



Photo 2-4

Part: Outer ring of a spherical roller bearing
Symptom: Peeling near the shoulder of the raceway over the entire circumference
Cause: Poor lubrication

2.3.3 Scoring

Damage	Possible Causes	Countermeasures
Surface damage due to accumulated small seizures caused by sliding under improper lubrication or under severe operating conditions. Linear damage appears circumferentially on the raceway surface and rolling surface. Cycloidal shaped damage appears on the roller end, while scoring on the rib surface appears on the contacting roller end.	<ul style="list-style-type: none"> Excessive load, excessive preload Poor lubrication Particles caught in the surface Inclination of inner and outer rings Shaft bending Poor precision of the shaft and housing 	<ul style="list-style-type: none"> Check the size of the load Adjust the preload Improve the lubricant and the lubrication method Check the precision of the shaft and housing

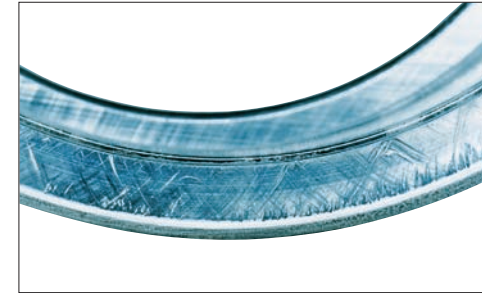

Photo 3-5
Part: Inner ring of a spherical thrust roller bearing
Symptom: Scoring on the rib face of inner ring
Cause: Debris caught in the surface and excessive axial load



Photo 3-6
Part: Convex rollers of Photo 3-5
Symptom: Scoring on the roller end face
Cause: Debris caught in surface and excessive axial load



Photo 3-1
Part: Inner ring of a spherical roller bearing
Symptom: Scoring on large rib face of inner ring
Cause: Roller slippage due to sudden acceleration and deceleration



Photo 3-2
Part: Convex rollers of Photo 3-1
Symptom: Scoring on roller end face
Cause: Roller slippage due to sudden acceleration and deceleration



Photo 3-7
Part: Cage of a deep groove ball bearing
Symptom: Scoring on the pressed-steel cage pockets
Cause: Entry of debris



Photo 3-8
Part: Outer ring of a double-row cylindrical roller bearing
Symptom: Notable scoring on the face of an outer ring rib
Cause: Excessive axial load



Photo 3-3
Part: Inner ring of a tapered roller thrust bearing
Symptom: Scoring on the face of inner ring rib
Cause: Worn particles mixed with lubricant and breakdown of oil film due to excessive load



Photo 3-4
Part: Rollers of a double-row cylindrical roller bearing
Symptom: Scoring on the roller end face
Cause: Poor lubrication and excessive axial load

2.3.4 Smearing

Damage	Possible Causes	Countermeasures
Surface damage that occurs from many small seizures between bearing components caused by oil film rupture and/or sliding. Surface roughening occurs along with melting.	<ul style="list-style-type: none"> • High speed and light load • Sudden acceleration/deceleration • Improper lubricant • Entry of water 	<ul style="list-style-type: none"> ➢ Improve the preload ➢ Improve the bearing clearance ➢ Use a lubricant with good oil film formation ➢ Improve the lubrication method ➢ Improve the sealing mechanism



Photo 4-5
Part: Inner ring of a spherical roller bearing
Symptom: Partial smearing circumferentially on raceway surface
Cause: Poor lubrication

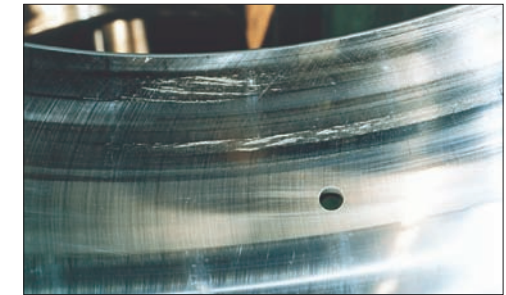

Photo 4-6
Part: Outer ring of Photo 4-5
Symptom: Partial smearing circumferentially on raceway surface
Cause: Poor lubrication



Photo 4-1
Part: Inner ring of a cylindrical roller bearing
Symptom: Smearing circumferentially on raceway surface
Cause: Roller slippage due to excessive grease filling

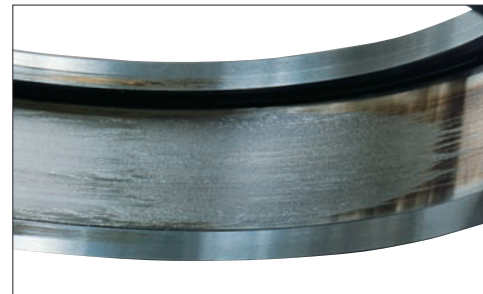

Photo 4-2
Part: Outer ring of Photo 4-1
Symptom: Smearing circumferentially on raceway surface
Cause: Roller slippage due to excessive grease filling



Photo 4-7
Part: Convex rollers of Photo 4-5
Symptom: Smearing at the center of the rolling surface
Cause: Poor lubrication



Photo 4-8
Part: Rollers of a large cylindrical roller bearing
Symptom: Smearing on rolling surface
Cause: Light load and poor lubrication



Photo 4-3
Part: Inner ring of a spherical roller bearing
Symptom: Smearing circumferentially on raceway surface
Cause: Poor lubrication



Photo 4-4
Part: Outer ring of Photo 4-3
Symptom: Smearing circumferentially on raceway surface
Cause: Poor lubrication



Photo 4-9
Part: Outer ring of a large tapered roller bearing
Symptom: Smearing on outer ring raceway surface
Cause: High speed, light load, and poor lubrication

2.3.5 Fracture

Damage	Possible Causes	Countermeasures
Small pieces broken off due to excessive load or shock load act locally on a part of the roller corner or rib of a raceway ring.	<ul style="list-style-type: none"> • Shock during mounting • Excessive load • Poor handling, such as dropping 	<ul style="list-style-type: none"> ➢ Improve the mounting method (shrink fit, use of proper tools) ➢ Reconsider load conditions ➢ Provide enough backup and support for the bearing rib

2.3.6 Cracks

Damage	Possible Causes	Countermeasures
Fissures in the raceway ring and rolling elements. Continued use in this condition leads to larger cracks or fractures.	<ul style="list-style-type: none"> • Excessive interference • Excessive load, shock load • Progression of flaking • Heat generation and fretting caused by contact between mounting parts and raceway ring • Heat generation due to creep • Poor taper angle of tapered shaft • Poor cylindricality of shaft • Interference with bearing chamfer due to a large shaft corner radius 	<ul style="list-style-type: none"> ➢ Correct the interference ➢ Check load conditions ➢ Improve the mounting method ➢ Use an appropriate shaft shape



Photo 5-1
Part: Inner ring of a double-row cylindrical roller bearing
Symptom: Chipping at the center rib
Cause: Excessive load during mounting

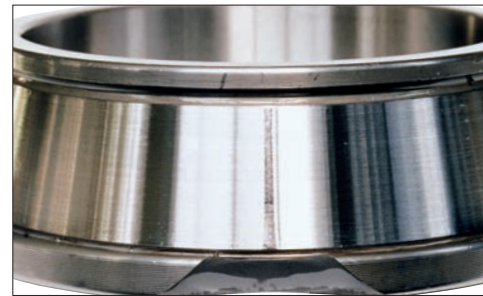

Photo 5-2
Part: Inner ring of a tapered roller bearing
Symptom: Fracture at the large rib
Cause: Large shock during mounting

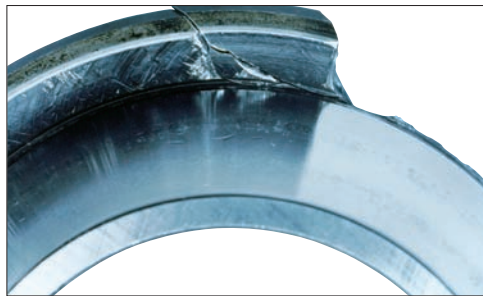

Photo 5-3
Part: Inner ring of a spherical thrust roller bearing
Symptom: Fracture at the large rib
Cause: Repeated load



Photo 5-4
Part: Outer ring of a solid type needle roller bearing
Symptom: Fracture at the outer ring rib
Cause: Roller inclination due to excessive loading (needle rollers are long compared to their diameter; under excessive or uneven loading, rollers become inclined and push against the ribs)

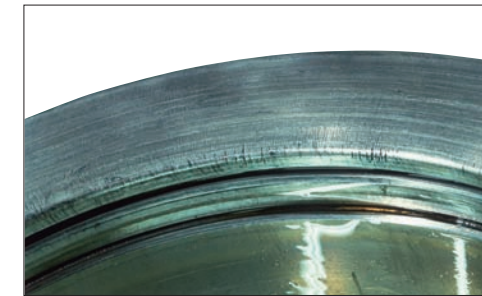

Photo 6-1
Part: Outer ring of a double-row cylindrical roller bearing
Symptom: Thermal cracks on the outer ring side face
Cause: Abnormal heat generation due to contact sliding between the mating part and face of outer ring



Photo 6-2
Part: Roller of a tapered roller thrust bearing
Symptom: Thermal cracks at large end face of roller
Cause: Heat generation due to sliding with the inner ring rib under poor lubrication



Photo 6-3
Part: Outer ring of a double-row cylindrical roller bearing
Symptom: Cracks propagated outward in the axial and circumferential directions from the flaking origin on the raceway surface
Cause: Flaking from a flaw due to shock load

2.3.7 Cage Damage

Damage	Possible Causes	Countermeasures
Various damage including cage deformation, fracture, and wear; fracture of cage pillar; deformation of side face; and wear of pocket surface or guide surface.	<ul style="list-style-type: none"> • Poor mounting (bearing misalignment) • Poor handling • Large moment load • Shock and large vibration • Excessive rotation speed, sudden acceleration/deceleration • Poor lubrication • Temperature rise 	<ul style="list-style-type: none"> ➢ Check the mounting method ➢ Check the temperature, rotation, and load conditions ➢ Reduce vibration ➢ Select a different cage type ➢ Select a different lubrication method or lubricant

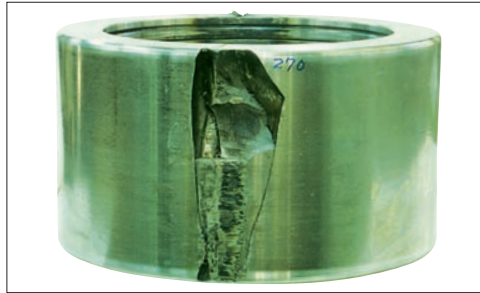

Photo 6-4
Part: Outer ring of a double-row cylindrical roller bearing (outer ring rotation)
Symptom: Cracks on outside surface
Cause: Flat wear and heat generation due to non-rotation of the outer ring

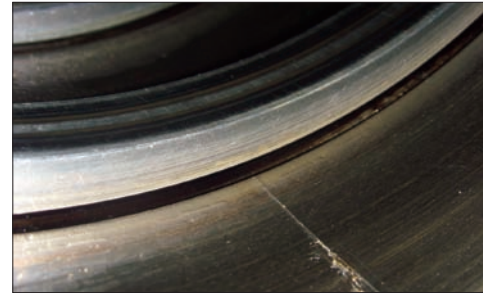

Photo 6-5
Part: Outer ring of a cylindrical roller bearing for Sendzimir mills
Symptom: Fatigue crack on outer ring raceway surface
Cause: Bending stress (large rotating outer ring load)



Photo 6-6
Part: Inner ring of a spherical roller bearing
Symptom: Axial cracks on raceway surface
Cause: Large fitting stress due to temperature difference between shaft and inner ring



Photo 6-7
Part: Cross section of a fractured inner ring in Photo 6-6
Symptom: Flaking origin directly beneath the raceway surface

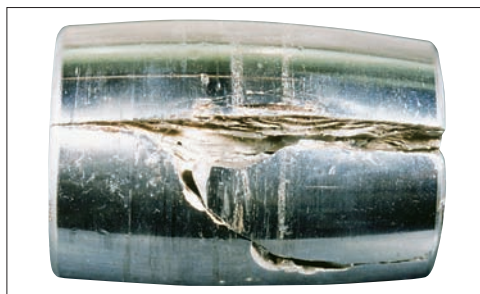

Photo 6-8
Part: Roller of a spherical roller bearing
Symptom: Axial cracks on rolling surface



Photo 6-9
Part: Outer ring of four-row tapered roller bearing
Symptom: Secondary damage after flaking on outer ring raceway surface



Photo 7-1
Part: Cage of a deep groove ball bearing
Symptom: Fracture of pressed-steel cage pocket



Photo 7-2
Part: Cage of an angular contact ball bearing
Symptom: Pocket pillar fractures from a cast-iron machined cage
Cause: Abnormal load action on cage due to misaligned mounting between inner and outer rings

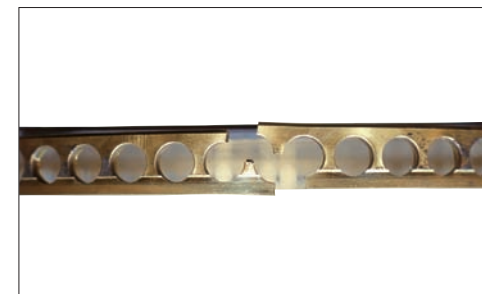

Photo 7-3
Part: Cage of an angular contact ball bearing
Symptom: Fracture of machined high-tension-brass cage



Photo 7-4
Part: Cage of a tapered roller bearing
Symptom: Pillar fractures of pressed-steel cage

2.3.8 Denting

Damage	Possible Causes	Countermeasures
<p>When debris such as small metallic particles are caught in the rolling contact zone, denting occurs on the raceway surface or rolling element surface.</p> <p>Denting can occur at the rolling element pitch interval if there is a shock during mounting (Brinell dents).</p>	<ul style="list-style-type: none"> • Debris such as metallic particles caught in the surface • Excessive load • Shock during transport or mounting 	<ul style="list-style-type: none"> ➢ Wash the housing ➢ Improve the sealing mechanism ➢ Filter the lubrication oil ➢ Improve the mounting and handling methods



Photo 7-5
Part: Cage of an angular contact ball bearing
Symptom: Pressed-steel cage deformation
Cause: Shock load due to poor handling

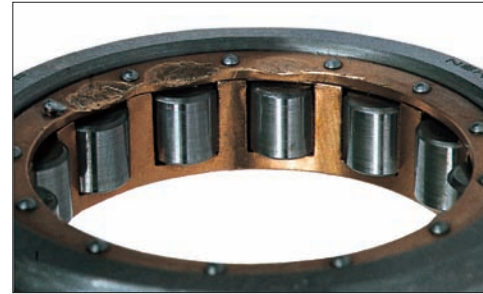

Photo 7-6
Part: Cage of a cylindrical roller bearing
Symptom: Deformation of the side face of a machined high-tension-brass cage
Cause: Large shock load during mounting



Photo 7-7
Part: Cage of a cylindrical roller bearing
Symptom: Deformation and wear of a machined high-tension-brass cage

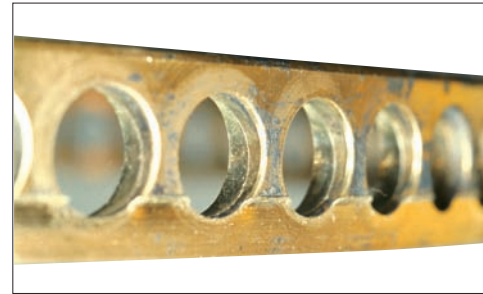

Photo 7-8
Part: Cage of an angular contact ball bearing
Symptom: Stepped wear on the outside surface and pocket surface of a machined high-tension-brass cage



Photo 8-1
Part: Inner ring of a double-row tapered roller bearing
Symptom: Frosted raceway surface
Cause: Debris caught in the surface



Photo 8-2
Part: Outer ring of a double-row tapered roller bearing
Symptom: Indentations on raceway surface
Cause: Debris caught in the surface

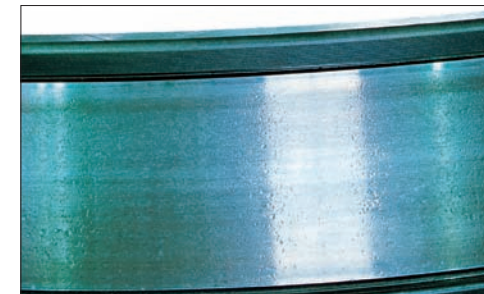

Photo 8-3
Part: Inner ring of a tapered roller bearing
Symptom: Small and large indentations over entire raceway surface
Cause: Debris caught in the surface



Photo 8-4
Part: Tapered rollers of Photo 8-3
Symptom: Small and large indentations over the rolling surface
Cause: Debris caught in the surface

2.3.9 Pitting

Damage	Possible Causes	Countermeasures
The surface of the rolling element or raceway has small holes and a dull luster.	<ul style="list-style-type: none"> • Debris caught in the lubricant • Exposure to moisture in the atmosphere • Poor lubrication 	<ul style="list-style-type: none"> ➢ Improve the sealing mechanism ➢ Filter the lubrication oil thoroughly ➢ Use another appropriate lubricant



Photo 9-1
Part: Outer ring of a slewing bearing
Symptom: Pitting on the raceway surface
Cause: Rust at bottom of indentations



Photo 9-2
Part: Ball of Photo 9-1
Symptom: Pitting on the rolling element surface

2.3.10 Wear

Damage	Possible Causes	Countermeasures
Surface deterioration due to sliding friction at the surface of the raceway, rolling elements, roller end faces, rib face, cage pockets, etc.	<ul style="list-style-type: none"> • Entry of debris • Progression from rust and electrical corrosion • Poor lubrication • Sliding due to irregular motion of rolling elements 	<ul style="list-style-type: none"> ➢ Improve the sealing mechanism ➢ Clean the housing ➢ Filter the lubrication oil thoroughly ➢ Check the lubricant and lubrication method ➢ Prevent misalignment



Photo 10-1
Part: Inner ring of a cylindrical roller bearing
Symptom: Pits and wave-shaped wear on raceway surface
Cause: Electrical erosion

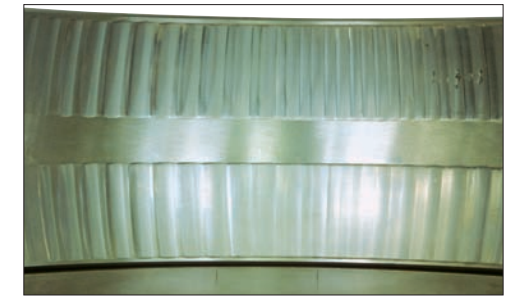

Photo 10-2
Part: Outer ring of a spherical roller bearing
Symptom: Wear with a wavy or concave-and-convex texture on loaded side of raceway surface
Cause: Entry of debris under repeated vibration while stationary



Photo 10-3
Part: Outer ring of a spherical roller bearing
Symptom: Wear on loaded side of raceway surface
Cause: Low speed, heavy load, and poor lubrication (no oil film)



Photo 10-4
Part: Outer ring of a spherical roller bearing (enlargement)
Symptom: Combined flaking and wear on the raceway
Cause: Insufficient oil film due to poor lubrication led to wear (primary damage) that progressed to flaking (secondary damage)

2.3.11 Fretting

Damage	Possible Causes	Countermeasures
A type of wear due to repeated sliding between two surfaces. Fretting occurs at the fitting surface and at the contact area between the raceway ring and rolling elements. Fretting corrosion is another term used to describe reddish brown or black worn particles.	<ul style="list-style-type: none"> • Poor lubrication • Vibration with a small amplitude • Insufficient interference 	<ul style="list-style-type: none"> ➢ Use a proper lubricant ➢ Apply a preload ➢ Check the interference fit ➢ Apply a film of lubricant to the fitting surface



Photo 10-5

Part: Outer ring of a tapered roller bearing
Symptom: Wear on outer ring raceway surface
Cause: Insufficient oil film and wear due to poor lubrication

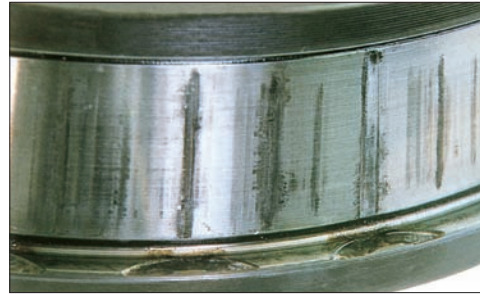

Photo 10-6

Part: Inner ring of a double-row tapered roller bearing
Symptom: Fretting wear of raceway and stepped wear on the rib face
Cause: Progression of fretting due to excessive load while stationary



Photo 10-7

Part: Tapered rollers of Photo 10-6
Symptom: Stepped wear on the roller head and face
Cause: Progression of fretting due to excessive load while stationary



Photo 11-1

Part: Inner ring of a deep groove ball bearing
Symptom: Fretting on the bore surface
Cause: Vibration



Photo 11-2

Part: Inner ring of an angular contact ball bearing
Symptom: Notable fretting over entire circumference of bore surface
Cause: Insufficient interference fit

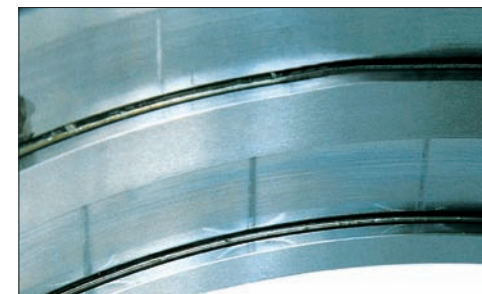

Photo 11-3

Part: Outer ring of a double-row cylindrical roller bearing
Symptom: Fretting on the raceway surface at roller pitch intervals

2.3.12 False Brinelling

Damage	Possible Causes	Countermeasures
Hollow spots that resemble Brinell dents that are due to wear caused by vibration and swaying at the contact points between the rolling elements and raceway.	<ul style="list-style-type: none"> • Oscillation and vibration of a stationary bearing during transport, etc. • Oscillating motion with a small amplitude • Poor lubrication 	<ul style="list-style-type: none"> ➢ Secure the shaft and housing during transport ➢ Transport with the inner and outer rings packed separately ➢ Reduce vibration by preloading ➢ Use another appropriate lubricant



Photo 12-1
Part: Inner ring of a deep groove ball bearing
Symptom: False brinelling on the raceway
Cause: Vibration from an external source while stationary



Photo 12-2
Part: Outer ring of Photo 12-1
Symptom: False brinelling on the raceway
Cause: Vibration from an external source while stationary



Photo 12-3
Part: Outer ring of a thrust ball bearing
Symptom: False brinelling of raceway surface at ball pitch intervals
Cause: Repeated vibration with a small oscillating angle



Photo 12-4
Part: Rollers of a cylindrical roller bearing
Symptom: False brinelling on rolling surface
Cause: Vibration from an external source while stationary

2.3.13 Seizure

Damage	Possible Causes	Countermeasures
When sudden overheating occurs during rotation, the bearing becomes discolored. If operation continues, the raceway rings, rolling elements, and cage will soften, melt, and deform as damage accumulates.	<ul style="list-style-type: none"> • Poor lubrication • Excessive load (excessive preload) • Excessive rotational speed • Excessively small internal clearance • Entry of water and debris • Poor precision of shaft and housing, excessive shaft bending 	<ul style="list-style-type: none"> ➢ Review the lubricant and lubrication method ➢ Re-investigate the suitability of the bearing type selected ➢ Review the preload, bearing clearance, and fitting ➢ Improve the sealing mechanism ➢ Check the precision of the shaft and housing ➢ Improve the mounting method



Photo 13-1
Part: Inner ring of a spherical roller bearing
Symptom: Discoloration and melting of raceway. Worn particles from the cage rolled off and attached to the raceway.
Cause: Insufficient lubrication



Photo 13-2
Part: Convex rollers of Photo 13-1
Symptom: Discoloration and melting of roller rolling surface, adhesion of worn particles from cage
Cause: Insufficient lubrication

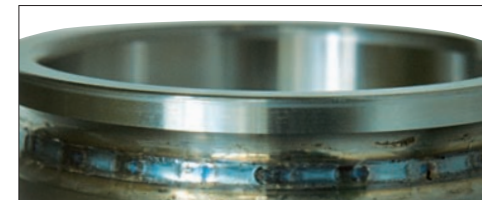

Photo 13-3
Part: Inner ring of an angular contact ball bearing
Symptom: Raceway discoloration, melting at ball pitch intervals
Cause: Excessive preload



Photo 13-4
Part: Outer ring in Photo 13-3
Symptom: Raceway discoloration, melting at ball pitch intervals
Cause: Excessive preload



Photo 13-5
Part: Balls and cage of Photo 13-3
Symptom: Cage damaged by melting, balls discolored and melted
Cause: Excessive preload



Photo 13-6
Part: Rollers of a large tapered roller bearing
Symptom: Seizure at large end face of roller
Cause: Poor lubrication and excessive axial load



Photo 13-7
Part: Cylindrical roller bearing
Symptom: Seizure of roller at ring raceway surface
Cause: Excessively small internal clearance generated heat from motion of the inner ring and rollers under high speed and light load

2.3.14 Creep

Damage	Possible Causes	Countermeasures
A phenomenon in bearings where relative slippage occurs at the fitting surfaces. Creep causes a shiny appearance, occasionally with scoring or wear.	<ul style="list-style-type: none"> • Insufficient interference or loose fit • Insufficient sleeve tightening 	<ul style="list-style-type: none"> ➢ Check interference and prevent rotation ➢ Correct the sleeve tightening ➢ Review precision of the shaft and housing ➢ Apply axial preload ➢ Tighten the raceway ring side face ➢ Apply adhesive to the fitting surface ➢ Apply a film of lubricant to the fitting surface



Photo 14-1
Part: Inner ring of a spherical roller bearing
Symptom: Creep accompanied by scoring of bore surface
Cause: Insufficient interference

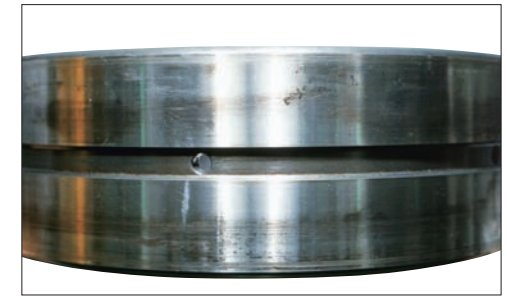

Photo 14-2
Part: Outer ring of a spherical roller bearing
Symptom: Creep over entire circumference of outside surface
Cause: Loose fit between outer ring and housing

2.3.15 Electrical Erosion

Damage	Possible Causes	Countermeasures
When electric current passes through a bearing, arcing and burning occur throughout the thin oil film at points of contact between the race and rolling elements. The points of contact are melted locally to form "fluting" or groove-like corrugations which can be seen by the naked eye. Magnification of these grooves reveals crater-like depressions that indicate melting by arcing.	<ul style="list-style-type: none"> • Electric potential difference between inner and outer rings • High-frequency electric potential difference generated by instruments or substrates used near a bearing. 	<ul style="list-style-type: none"> ➢ Design electric circuits that prevent current flow through the bearings ➢ Insulate the bearing

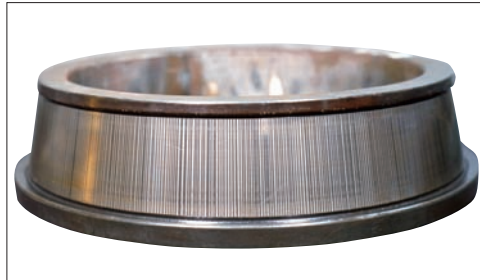

Photo 15-1
Part: Inner ring of a tapered roller bearing
Symptom: Striped pattern of erosion on the raceway surface



Photo 15-2
Part: Tapered rollers in Photo 15-1
Symptom: Striped pattern of erosion on the rolling surface



Photo 15-3
Part: Inner ring of a cylindrical roller bearing
Symptom: Belt pattern of electrical erosion accompanied by pits on the raceway surface



Photo 15-4
Part: Balls of a deep groove ball bearing
Symptom: A dark color covering the entire ball surface

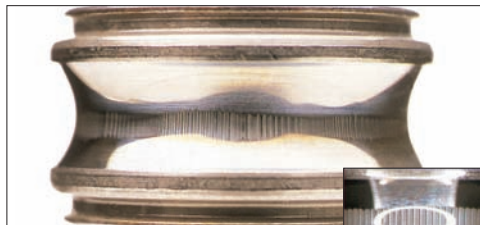

Photo 15-5
Part: Inner ring of a deep groove ball bearing
Symptom: Fluting on the raceway surface (high frequency)



Photo 15-6
Part: Outer ring of a deep groove ball bearing
Symptom: Fluting on the raceway surface (high frequency)

2.3.16 Rust and Corrosion

Damage	Possible Causes	Countermeasures
Pits on the surface of rings and rolling elements. These may occur at the rolling element pitch on the rings or over entire bearing surfaces.	<ul style="list-style-type: none"> • Entry of corrosive gas or water • Improper lubricant • Formation of water droplets due to condensation • High temperature and high humidity while stationary • Poor rust preventive treatment during transport • Improper storage conditions • Improper handling 	<ul style="list-style-type: none"> ➢ Improve the sealing mechanism ➢ Review the lubrication method ➢ Apply an anti-rust treatment during idle periods ➢ Improve storage methods ➢ Improve handling



Photo 16-1
Part: Outer ring of a cylindrical roller bearing
Symptom: Rust on the rib face and raceway surface
Cause: Poor lubrication due to water entry

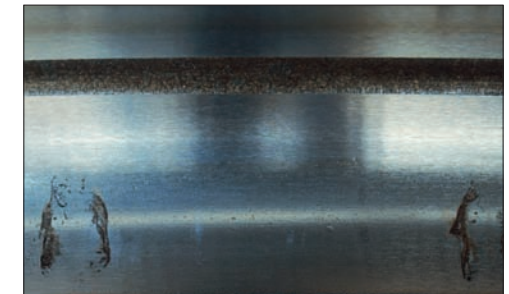

Photo 16-2
Part: Outer ring of a slewing ring
Symptom: Rust on raceway surface at ball pitch
Cause: Condensation during stationary periods



Photo 16-3
Part: Inner ring of a spherical roller bearing
Symptom: Rust on raceway surface at roller pitch
Cause: Entry of water into lubricant



Photo 16-4
Part: Rollers of a spherical roller bearing
Symptom: Pit-shaped rust on rolling contact surface, corroded portions
Cause: Condensation during storage

2.3.17 Mounting Flaws

Damage	Possible Causes	Countermeasures
Straight-line scratches on surface of raceways or rolling elements caused during mounting or dismounting.	<ul style="list-style-type: none"> • Inclination of inner and outer rings during mounting or dismounting • Shock load during mounting or dismounting 	<ul style="list-style-type: none"> ➢ Use appropriate jigs and tools ➢ Avoid shock load by using a press machine ➢ Center the relative mating parts during mounting

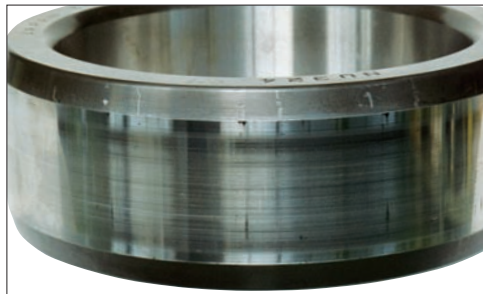

Photo 17-1
Part: Inner ring of a cylindrical roller bearing
Symptom: Axial scratches on raceway surface
Cause: Inclination of inner and outer rings during mounting



Photo 17-2
Part: Outer ring of a double-row cylindrical roller bearing
Symptom: Axial scratches at roller pitch intervals on raceway surface
Cause: Inclination of inner and outer rings during mounting



Photo 17-3
Part: Rollers of a cylindrical roller bearing
Symptom: Axial scratches on rolling surface
Cause: Inclination of inner and outer rings during mounting

2.3.18 Discoloration

Damage	Possible Causes	Countermeasures
Changed coloring of cage, rolling elements, or raceway ring due to reactions with lubricant and high temperature.	<ul style="list-style-type: none"> • Poor lubrication • Oil stain due to a reaction with lubricant • High temperature 	<ul style="list-style-type: none"> ➢ Improve the lubrication method

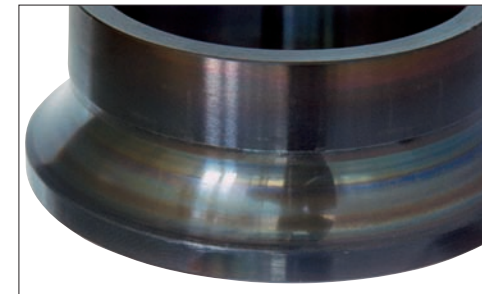

Photo 18-1
Part: Inner ring of an angular contact ball bearing
Symptom: Bluish or purplish discoloration on raceway surface
Cause: Heat generation due to poor lubrication

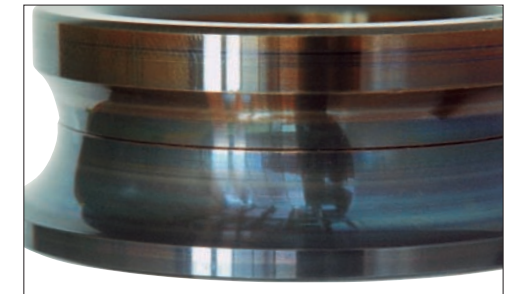

Photo 18-2
Part: Inner ring of a four-point contact ball bearing
Symptom: Bluish or purplish discoloration on raceway surface
Cause: Heat generation due to poor lubrication

Appendix: Bearing Diagnostic Chart

Damage	Location (Phenomenon)	Cause											Remarks		
		Handling		Bearing Surroundings			Lubrication		Load			Speed			
		Storage, Transport	Mounting	Shaft, Housing	Seal, Water, Debris	Temperature	Lubricant	Lubrication Method	Excessive Load, Shock Load	Moment Load	Ultra-Small Load	High Speed, High Acceleration/Deceleration		Shaking, Vibration, Stationary	Bearing Selection
2.3.1 Flaking (Spalling)	Raceway, rolling surface		○	○	○		○	○	○	○				○	
2.3.2 Peeling	Raceway, rolling surface				○		○	○			○	○			
	Bearing outside surface (rolling contact)			○*	○		○	○							*Mating part
2.3.3 Scoring	Roller end face surface, rib surface		○	○	○		○	○	○	○		○			
	Cage guide surface, pocket surface		○		○		○	○							
2.3.4 Smearing	Raceway, rolling surface				○		○	○			○	○			
2.3.5 Fracture	Raceway collar, rollers	○	○	○				○	○						
2.3.6 Cracks	Raceway rings, rolling elements		○	○		○		○	○						
	Rib surface, roller end face, cage guide surface (thermal crack)			○			○	○	○						
2.3.7 Cage damage	Deformation, fracture		○	○				○	○						
	Wear		○		○		○	○	○		○				
2.3.8 Denting	Raceway, rolling surface, (many small dents)				○		○								
	Raceway (debris on the rolling element pitch)	○	○					○				○			
2.3.9 Pitting	Raceway, rolling surface				○		○	○							
2.3.10 Wear	Raceway, rolling surface, rib surface, roller end face		○		○		○	○							
2.3.11 Fretting	Raceway, rolling surface	○	○	○			○	○	○		○	○			
	Bearing outside & bore, side surface (contact with housing and shaft)		○	○				○							
2.3.12 False brinelling	Raceway, rolling surface	○					○	○				○			
2.3.13 Seizure	Raceway ring, rolling element, cage		○	○	○		○	○	○		○		○		
2.3.14 Creep	Fitting surface		○	○		○	○*	○*	○		○				*Clearance fit
2.3.15 Electrical erosion	Raceway, rolling surface		○*	○*											*Electricity passing through the rolling element
2.3.16 Rust and corrosion	Raceway ring, rolling element, cage	○	○		○	○	○	○							
2.3.17 Mounting flaws	Raceway, rolling surface		○	○											
2.3.18 Discoloration	Raceway ring, rolling element, cage					○	○	○							

Remark This chart is not comprehensive; it lists only the more commonly occurring damages, causes, and locations.



BEARING TABLES

Part C**BEARING TABLES**

1. DEEP GROOVE BALL BEARINGS	C 005
2. EXTRA SMALL BALL BEARINGS AND MINIATURE BALL BEARINGS	C 053
3. ANGULAR CONTACT BALL BEARINGS	C 071
4. SELF-ALIGNING BALL BEARINGS	C 113
5. CYLINDRICAL ROLLER BEARINGS	C 123
6. TAPERED ROLLER BEARINGS	C 181
7. SPHERICAL ROLLER BEARINGS	C 257
8. THRUST BALL BEARINGS	C 295
9. THRUST CYLINDRICAL ROLLER BEARINGS	C 313
10. THRUST TAPERED ROLLER BEARINGS	C 321
11. THRUST SPHERICAL ROLLER BEARINGS	C 331
12. NEEDLE ROLLER BEARINGS	C 341
13. BALL BEARING UNITS	C 343
14. PLUMMER BLOCKS	C 345
15. ACCESSORIES FOR ROLLING BEARINGS	C 347



1. DEEP GROOVE BALL BEARINGS

INTRODUCTION C 006

TECHNICAL DATA

Radial and Axial Internal Clearances and Contact Angles for Single-Row Deep Groove Ball Bearings C 012

Features and Operating Temperature Range of Ball Bearing Seal Material C 016

Free Space and Grease Filling Amount for Deep Groove Ball Bearings C 018

BEARING TABLES

Single-Row Deep Groove Ball Bearings

Open, Shielded, and Sealed Types

Bore Diameter 10 – 240 mm C 020

Open Type

Bore Diameter 260 – 800 mm C 040

Creep-Free Bearings™

Bore Diameter 10 – 100 mm C 046

Maximum Ball Bearings

Bore Diameter 25 – 110 mm C 048

Magneto Bearings

Bore Diameter 4 – 20 mm C 050



DESIGN, TYPES, AND FEATURES

SINGLE-ROW DEEP GROOVE BALL BEARINGS

Single-row deep groove ball bearings are classified into the types shown below.

The proper amount of good quality grease is packed in shielded and sealed ball bearings. A comparison of the features of each type is shown in Table 1.

Table 1 Features of Sealed Ball Bearings

Type	Shielded (ZZ Type)	Rubber Non-Contact Seal (VV Type)	Rubber Contact Seal (DDU Type)
Torque	Low	Low	Higher than ZZ and VV types due to contact seal
Speed capability	Good	Good	Limited by contact seals
Grease-sealing effectiveness	Good	Better than ZZ type	Slightly better than VV type
Dust resistance	Good	Better than ZZ type (usable in moderately dusty environments)	Best (usable even in very dusty environments)
Water resistance	Not suitable	Not suitable	Good (usable even if fluid is splashed on bearing)
Operating temperature ⁽¹⁾	-10 to +110 °C	-10 to +110 °C	-10 to +100 °C

Note ⁽¹⁾ The above temperature range applies to standard bearings. By using cold- or heat-resistant grease or changing the type of rubber, the operating temperature range can be extended. Please contact NSK for such applications.

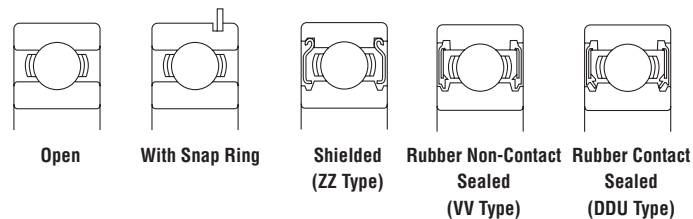

Pressed cages are usually used for deep groove ball bearings. For large bearings, machined brass cages are used (refer to Table 2).
Machined cages are also used for high-speed applications.

Table 2 Standard Cages for Deep Groove Ball Bearings

Series	Pressed Steel Cages	Machined Brass Cages
68	6800 – 6838	6840 – 68/800
69	6900 – 6936	6938 – 69/800
160	16001 – 16026	16028 – 16064
60	6000 – 6040	6044 – 60/670
62	6200 – 6240	6244 – 6272
63	6300 – 6332	6334 – 6356

Formulation of Bearing Designations

Single-row deep groove ball bearings

Example:

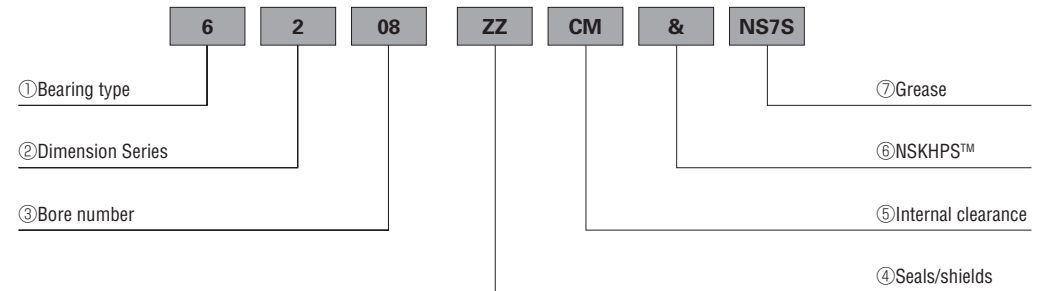

- ① Bearing type: 6 : Single-row deep groove ball bearings
- ② Dimension Series: 2 : 02 Series, 3 : 03 Series, 9 : 19 Series, 0 : 10 Series
- ③ Bore number: Less than 03, Bearing bore 00 : 10mm, 01 : 12mm, 02 : 15mm, 03 : 17mm
Over 04, Bearing bore bore number X 5 (mm)
- ④ Seals/shields: ZZ : Shield on both sides, DDU: Rubber contact seal on both sides, VV: Rubber non-contact seal on both sides, Z: Shield on one side, DU: Rubber contact seal on one side V:Rubber non-contact seal on one side
- ⑤ Internal clearance: Omitted : CN clearance*¹, C3 : Clearance greater than CN, C4 : Clearance greater than C3, CM : For electric motors*¹
- ⑥ NSKHPS™ designation: & : NSKHPS™ Bearings
- ⑦ Grease designation*²: NS7 : NS HI-LUBE

* 1 CM clearance may be used instead of CN clearance (the reverse is not possible).

* 2 The grease designation is required when seals/shields are used on both sides.

NSKHPS™ Deep Groove Ball Bearings

Features Compared with conventional bearings:

Compared with conventional bearings ...

Bearing Life

15% longer

Wide lineup

- Improved reliability
Bearing life is 15% longer than conventional bearings thanks to optimization of the bearing's internal design and improvement of processing technology. As a result, NSKHPS™ bearings contribute to reducing maintenance costs and facilitate the downscaling of related equipment.
- New product lineup
The standard dimensions are identical to standard size bearings. NSK has expanded the lineup of NSKHPS™ bearings by focusing on a wide range of sizes offering a high degree of versatility for various general-purpose applications.

DEEP GROOVE BALL BEARINGS

Creep-Free Bearings™

Creep-Free bearings, which come with two O-rings mounted in the outer ring, help to prevent creep by restricting the amount of clearance between the outer ring and housing.

No special machining is required; therefore bearings can be used with the same housing as standard bearings.

In creep limit load tests, the more housing clearance is reduced, the greater the improvements in creep prevention due to the tension of the O-ring mounted in the outer ring.

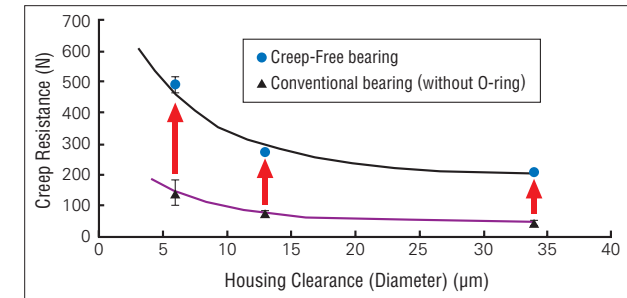
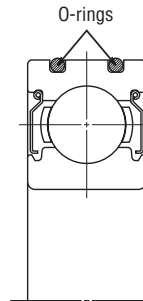

Fig. 1 Structure of Creep-Free Bearings

Fig. 2 Creep Limit Load Test (Example Bearing 6204)

Features

Prevents creep

O-rings help prevent creep.

Easy to assemble

Assembly is easy since bearings can be fitted with a loose tolerance.

Reusable housing

Very little abrasion occurs on the bore surface of the housing, making reuse possible.

No special machining of the housing required

Bearings can be easily replaced since boundary dimensions are identical to standard bearings. No reworking of the housing is required.

Application Examples

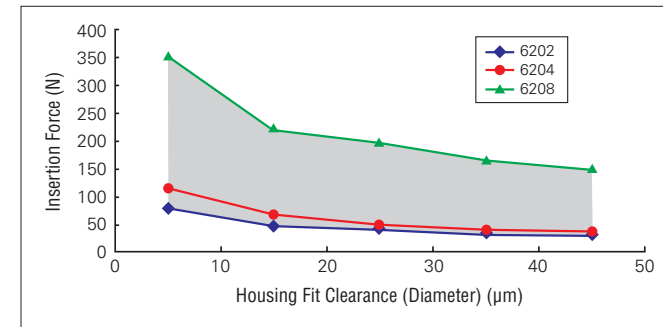

Fig. 3 Fit and Insertion Force

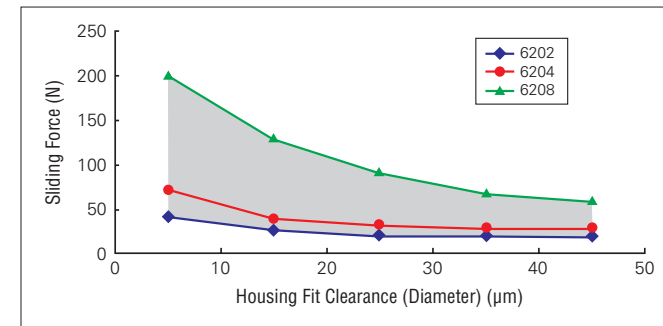

Fig. 4 Fit and Sliding Force



Note on Mounting Creep-Free Bearings

- When oil or grease is applied to the outer diameter of the bearing, use a mineral oil or a synthetic hydrocarbon oil (NSK's EA2, etc.).
- Nitrile rubber is used as the standard specification O-ring material (operating temperature range: -30 to 120 °C). Please contact NSK for use under special environments such as high temperatures.

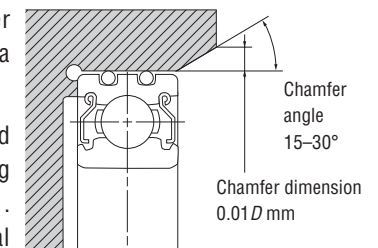
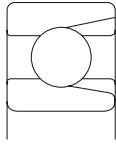

Fig. 5 Housing Shape and Dimension

Note that "free" in the product name "Creep-Free" bearings should not be understood as meaning that creep is nonexistent.

DEEP GROOVE BALL BEARINGS**MAXIMUM BALL BEARINGS**

Maximum ball bearings contain a larger number of balls than normal deep groove ball bearings because of filling slots in the inner and outer rings. Because of their filling slots, they are not suitable for applications with high axial loads.

BL2 and BL3 types of bearings have boundary dimensions equal to those of Series 62 and 63 deep groove ball bearings respectively. Besides the open type, ZZ type shielded bearings are also available.

When using these bearings, it is important for the filling slot in the outer ring to be outside of the loaded zone as much as possible.

The cages are made of pressed steel.

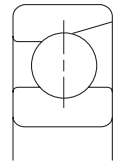
**MAGNETO BEARINGS**

The groove in the inner ring is slightly shallower than that of deep groove ball bearings and one side of the outer ring is relieved. Consequently, the outer ring is separable, which is convenient for mounting.

Pressed cages are standard, but for high-speed applications, machined synthetic resin cages are used.

PRECAUTIONS FOR USE OF DEEP GROOVE BALL BEARINGS

If the bearing load is too small during operation, slippage may occur between the balls and raceways, which may result in smearing. The higher the weight of the balls and cage, the more likely this will occur, especially for large bearings. If very small bearing loads are expected, please contact NSK for selection of an appropriate bearing.

TOLERANCES AND RUNNING ACCURACY

SINGLE-ROW DEEP GROOVE BALL BEARINGSTable 7.2 (Pages A128 to A131)
NSKHPS DEEP GROOVE BALL BEARINGS	
Tolerance for Dimensions : ISO Normal	
Running Accuracy : ISO Normal	
MAXIMUM BALL BEARINGSTable 7.2 (Pages A128 to A131)
MAGNETO BEARINGSTable 7.5 (Pages A138 and A139)

RECOMMENDED FITS

SINGLE-ROW DEEP GROOVE BALL BEARINGSTable 8.3 (Page A164)
	Table 8.5 (Page A165)
MAXIMUM BALL BEARINGSTable 8.3 (Page A164)
	Table 8.5 (Page A165)
MAGNETO BEARINGSTable 8.3 (Page A164)
	Table 8.5 (Page A165)

INTERNAL CLEARANCES

SINGLE-ROW DEEP GROOVE BALL BEARINGSTable 8.10 (Page A169)
NSKHPS DEEP GROOVE BALL BEARINGS	
INTERNAL CLEARANCE SYMBOL : CN, C3, C4, CM	
MAXIMUM BALL BEARINGSTable 8.10 (Page A169)
MAGNETO BEARINGSTable 8.12 (Page A169)

LIMITING SPEEDS (GREASE/OIL)

The limiting speeds for grease and oil lubrication listed in the bearing tables should be adjusted depending on bearing load. Furthermore, higher speeds are attainable by changing the lubrication method, cage design, etc. Refer to Page A098 for detailed information.

TECHNICAL DATA

Radial and Axial Internal Clearances and Contact Angles for Single-Row Deep Groove Ball Bearings

(1) Radial and Axial Internal Clearances

The internal clearance in single-row bearings is specified as the radial internal clearance. The bearing internal clearance is the amount of relative displacement possible between the bearing rings when one ring is fixed and the other ring does not bear a load. The amount of movement along the bearing radius is called the radial clearance, and the amount along the axis is called the axial clearance.

The geometric relation between radial and axial clearance is shown in Fig. 1.

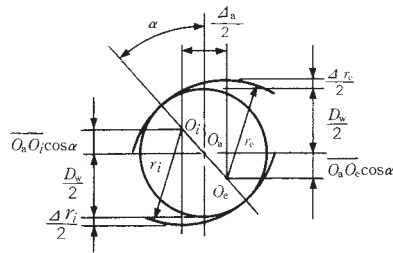

Fig. 1 Relationship Between Δr and Δa

Symbols used in Fig. 1

- O_a: Ball center
- O_e: Center of groove curvature, outer ring
- O_i: Center of groove curvature, inner ring
- D_w: Ball diameter (mm)
- r_e: Radius of outer ring groove (mm)
- r_i: Radius of inner ring groove (mm)
- α: Contact angle (°)
- Δ_r: Radial clearance (mm)
- Δ_a: Axial clearance (mm)

It is apparent from Fig. 1 that Δ_r=Δr_e+Δr_i.

Various equations for clearance, contact angle, etc. can be derived from geometric relationships:

$$\Delta_r = 2(1 - \cos \alpha)(r_e + r_i - D_w) \dots\dots\dots (1)$$

$$\Delta_a = 2 \sin \alpha (r_e + r_i - D_w) \dots\dots\dots (2)$$

$$\frac{\Delta_a}{\Delta_r} = \cot \frac{\alpha}{2} \dots\dots\dots (3)$$

$$\Delta_a \doteq 2 (r_e + r_i - D_w)^{1/2} \Delta_r^{1/2} \dots\dots\dots (4)$$

$$\alpha = \cos^{-1} \left(\frac{r_e + r_i - D_w - \frac{\Delta_r}{2}}{r_e + r_i - D_w} \right) \dots\dots\dots (5)$$

$$= \sin^{-1} \left(\frac{\Delta_a / 2}{r_e + r_i - D_w} \right) \dots\dots\dots (6)$$

Because (r_e+r_i-D_w) is a constant, fixed relationships between Δ_r, Δ_a, and α exist for all the various bearing types.

As previously mentioned, the clearances for deep groove ball bearings are given as radial clearances, but there are specific applications where an axial clearance is desirable as well. The relationship between deep groove ball bearing radial clearance Δ_r and axial clearance Δ_a is given in Equation (4). To simplify,

$$\Delta_a \doteq K \Delta_r^{1/2} \dots\dots\dots (7)$$

where K: Constant depending on bearing design
 $K = 2 (r_e + r_i - D_w)^{1/2}$

Fig. 2 shows one example. The various values for K are presented by bearing size in Table 1 below.

Example

Assume bearing 6312 has a radial clearance of 0.017 mm. From Table 1, K=2.09. Therefore, the axial clearance Δ_a is:
 $\Delta_a = 2.09 \times \sqrt{0.017} = 2.09 \times 0.13 = 0.27$ (mm)

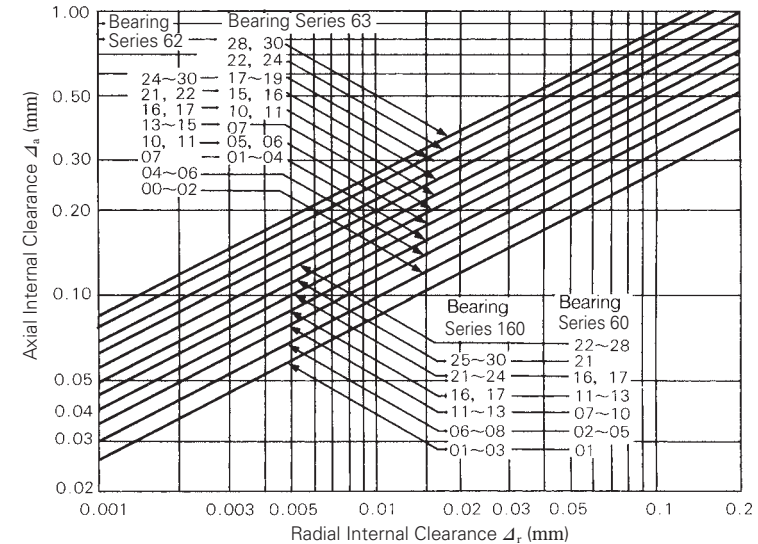

Fig. 2 Radial Clearance Δr and Axial Clearance Δa of Deep Groove Ball Bearings

Table 1 Constant Values of K for Radial and Axial Clearance Conversion

Bearing Bore No.	K			
	Series 160	Series 60	Series 62	Series 63
00	—	—	0.93	1.14
01	0.80	0.80	0.93	1.06
02	0.80	0.93	0.93	1.06
03	0.80	0.93	0.99	1.11
04	0.90	0.96	1.06	1.07
05	0.90	0.96	1.06	1.20
06	0.96	1.01	1.07	1.19
07	0.96	1.06	1.25	1.37
08	0.96	1.06	1.29	1.45
09	1.01	1.11	1.29	1.57
10	1.01	1.11	1.33	1.64
11	1.06	1.20	1.40	1.70
12	1.06	1.20	1.50	2.09
13	1.06	1.20	1.54	1.82
14	1.16	1.29	1.57	1.88
15	1.16	1.29	1.57	1.95
16	1.20	1.37	1.64	2.01
17	1.20	1.37	1.70	2.06
18	1.29	1.44	1.76	2.11
19	1.29	1.44	1.82	2.16
20	1.29	1.44	1.88	2.25
21	1.37	1.54	1.95	2.32
22	1.40	1.64	2.01	2.40
24	1.40	1.64	2.06	2.40
26	1.54	1.70	2.11	2.49
28	1.54	1.70	2.11	2.59
30	1.57	1.76	2.11	2.59

(2) Relation Between Radial Clearance and Contact Angle

Single-row deep groove ball bearings are sometimes used as thrust bearings. In such applications, the contact angle should be as large as possible.

The contact angle for ball bearings is determined by the geometric relationship between the radial clearance and radii of the inner and outer grooves. Using Equations (1) to (6), Fig. 3 shows the particular relationship between the radial clearance and contact angle of bearings in Series 62 and 63 bearings. The initial contact angle, α_0 , refers to the initial contact angle when axial load is zero. Application of any load to the bearing will change this contact angle.

If the initial contact angle α_0 exceeds 20°, check whether or not the contact area of the ball and raceway touch the edge of the raceway shoulder (refer to Section 8.1.2).

For applications where an axial load alone is applied, the radial clearance for deep groove ball bearings is normally greater than the normal clearance in order to ensure that the contact angle is relatively large. The initial contact angles for C3 and C4 clearances are given for selected bearing sizes in Table 2 below.

Table 2 Initial Contact Angle α_0 , With C3 and C4 Clearances

Bearing Designation	α_0 with C3	α_0 with C4
6205	12.5° to 18°	16.5° to 22°
6210	11.5° to 16.5°	13.5° to 19.5°
6215	11.5° to 16°	15.5° to 19.5°
6220	10.5° to 14.5°	14° to 17.5°
6305	11° to 16°	14.5° to 19.5°
6310	9.5° to 13.5°	12° to 16°
6315	9.5° to 13.5°	12.5° to 15.5°
6320	9° to 12.5°	12° to 15°

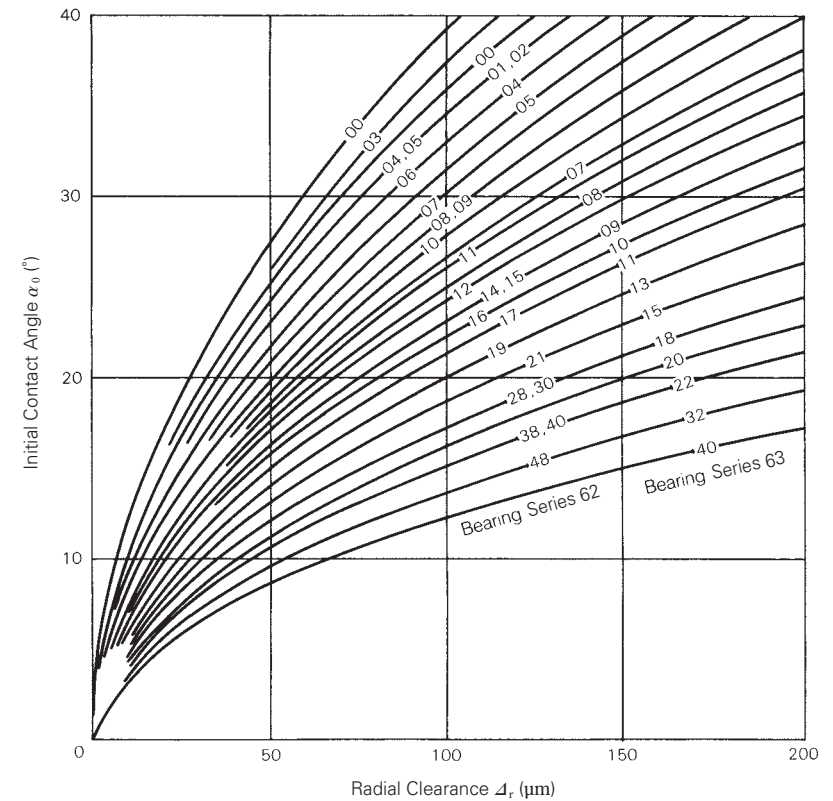

Fig. 3 Radial Clearance and Contact Angle

Features and Operating Temperature Range of Ball Bearing Seal Material

Sealed ball bearings are shown in Figs. 1 and 2. There are two seal types: non-contact seals and contact seals. Nitrile rubber is used for general-purpose applications, while polyacrylic, silicon, and fluorine rubbers are used based on operating temperature requirements. All rubbers have their own unique characteristics and must be selected while considering the application environment and operating conditions.

Table 1 shows principal features of each rubber material and the operating temperature range of the bearing seal. The operating temperature range of Table 1 is a guideline for continuous operation. Thermal aging of rubber is related to temperature and time. Rubber may be used in a much wider range of operating temperatures depending on the operating time and frequency.

Heat generation due to friction on the lip can be ignored in non-contact seals. Thermal factors, which cause aging of the rubber, refer to physical changes due to atmospheric and bearing temperatures. Accordingly, increased hardness or loss of elasticity due to thermal aging exerts only a negligible effect on seal performance. A rubber non-contact seal can thus be used in a greater range of operating temperatures than contact seals.

However, there are some disadvantages. Problems with friction-generated wear at the seal lip, thermal plastic deformation, and hardening may occur, causing the contact pressure between the lip and slide surface to decrease and result in a clearance. This clearance is low and does not degrade sealing performance (it does not cause dust entry or grease leakage). In most cases, this minor plastic deformation or increased hardness presents no practical problems.

However, in external environments with large amounts of dust and water, the bearing seal is used as an auxiliary seal and a main seal should be provided separately. As mentioned, the operating temperature range of rubber material is only a guideline for selection. Since heat resistant rubber is expensive, strive to understand temperature conditions so that an economical selection can be made. Pay attention not only to heat resistance, but also to the distinctive features of each rubber.

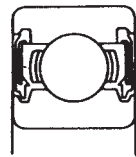

Rubber non-contact seal (VV)

Fig. 1

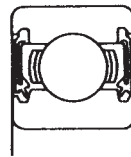

Rubber contact seal (DDU)

Fig. 2

Table 1 Features and Operating Temperature Range of Rubber Materials

Material		Nitrile Rubber	Polyacrylic Rubber	Silicon Rubber	Fluorine Rubber
Operating Temperature Range (1) (°C)	Non-Contact Seal	<ul style="list-style-type: none"> ○Most popular seal material ○Superior mechanical properties and resistance to oil and wear ○Readily ages under direct sunlight ○Less expensive than other rubbers 	<ul style="list-style-type: none"> ○Superior heat and oil resistances ○Large compression causes permanent deformation ○Inferior cold resistance ○One of the less expensive high-temperature materials ○Swells in contact with ester oil based grease 	<ul style="list-style-type: none"> ○High heat and cold resistances ○Inferior mechanical properties besides resistance to permanent deformation by compression. Note the tear strength ○Swells in contact with low-anilinepoint mineral oil, silicone grease, and silicone oil 	<ul style="list-style-type: none"> ○High heat resistance ○Superior oil and chemical resistances ○Cold resistance similar to nitrile rubber ○Deteriorates in contact with urea grease
	Contact Seal	<ul style="list-style-type: none"> ○High heat resistance ○Superior oil and chemical resistances ○Cold resistance similar to nitrile rubber ○Deteriorates in contact with urea grease 	<ul style="list-style-type: none"> ○High heat and cold resistances ○Inferior mechanical properties besides resistance to permanent deformation by compression. Note the tear strength ○Swells in contact with low-anilinepoint mineral oil, silicone grease, and silicone oil 	<ul style="list-style-type: none"> ○High heat and cold resistances ○Inferior mechanical properties besides resistance to permanent deformation by compression. Note the tear strength ○Swells in contact with low-anilinepoint mineral oil, silicone grease, and silicone oil 	<ul style="list-style-type: none"> ○High heat resistance ○Superior oil and chemical resistances ○Cold resistance similar to nitrile rubber ○Deteriorates in contact with urea grease

Note (1) This operating temperature refers to the temperature of rubber seal materials.

Free Space and Grease Filling Amount for Deep Groove Ball Bearings

Grease lubrication can simplify the bearing's peripheral construction. Thanks to enhanced grease quality, grease lubrication is now employed in place of oil lubrication in many fields. Be sure to select a grease appropriate for operating conditions. Take care with the filling amount, since too much or too little grease greatly affects the temperature rise and torque. The amount of grease needed depends on such factors as housing construction, free space, grease brand, and environment.

As a general guideline, the bearing is first filled with an appropriate amount of grease. Apply grease onto the cage guide surface, then, fill the free space, which excludes the spindle and bearing inside the housing, with the following amount of grease:

When bearing speed is 50% or less of the specified limiting speed, fill 1/2 to 2/3 of the free space.

When bearing speed is 50% or more of the specified limiting speed, fill 1/3 to 1/2 of the free space.

In general, low speeds require more grease while high speeds require less grease. Depending on the particular application, the filling amount may have to be reduced further to reduce the torque and prevent heat generation. When bearing speed is extremely low on the other hand, grease may be packed almost full to prevent dust and water entry. Accordingly, one must know the extent of the housing's free space for the specific bearing to determine the correct filling amount. The volume of free space is shown in Table 1 for an open deep groove ball bearing for reference.

Note that the free space of the open type deep groove ball bearing is the volume obtained by subtracting the volume of the balls and cage from the space formed between inner and outer rings.

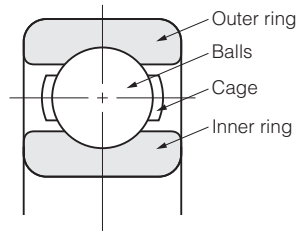

Table 1 Free Space of Open Deep Groove Ball Bearings

Units : cm³

Bearing Bore No.	Bearing Free Space			Bearing Bore No.	Bearing Free Space		
	Bearing Series				Bearing Series		
	60	62	63		60	62	63
00	1.2	1.5	2.9	14	34	61	148
01	1.2	2.1	3.5	15	35	67	180
02	1.6	2.7	4.8	16	47	84	213
03	2.0	3.7	6.4	17	48	104	253
04	4.0	6.0	7.9	18	63	127	297
05	4.6	7.7	12	19	66	155	345
06	6.5	11	19	20	68	184	425
07	9.2	15	25	21	88	216	475
08	11	20	35	22	114	224	555
09	14	23	49	24	122	310	675
10	15	28	64	26	172	355	830
11	22	34	79	28	180	415	1 030
12	23	45	98	30	220	485	1 140
13	24	54	122	32	285	545	1 410

Remark The table above shows the free space of bearings using pressed-steel cages. The free space of a bearing using a high-tension machined-brass cage is about 50 to 60% of the value in this table.

SINGLE-ROW DEEP GROOVE BALL BEARINGS

Bore Diameter 10 – 17 mm

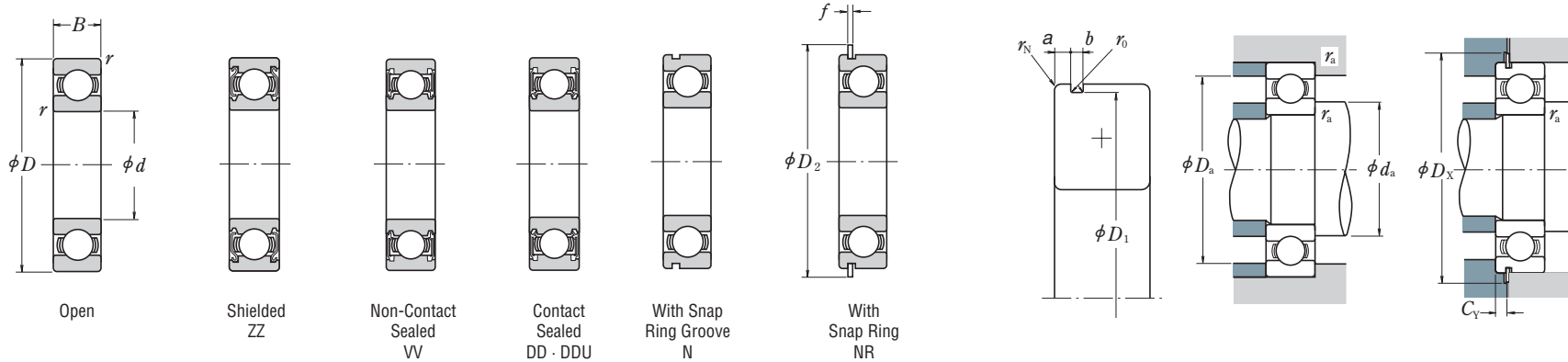

Dynamic Equivalent Load

$$P = XF_r + YF_a$$

$\frac{f_0 F_a}{C_{0r}}$	e	$\frac{F_a}{F_r} \leq e$		$\frac{F_a}{F_r} > e$	
		X	Y	X	Y
0.172	0.19	1	0	0.56	2.30
0.345	0.22	1	0	0.56	1.99
0.689	0.26	1	0	0.56	1.71
1.03	0.28	1	0	0.56	1.55
1.38	0.30	1	0	0.56	1.45
2.07	0.34	1	0	0.56	1.31
3.45	0.38	1	0	0.56	1.15
5.17	0.42	1	0	0.56	1.04
6.89	0.44	1	0	0.56	1.00

Static Equivalent Load

$$\frac{F_a}{F_r} > 0.8, P_0 = 0.6F_r + 0.5F_a$$

$$\frac{F_a}{F_r} \leq 0.8, P_0 = F_r$$

Boundary Dimensions (mm)	Basic Load Ratings (N)		Factor	Limiting Speeds (min ⁻¹)			Bearing Designations			Snap Ring Groove Dimensions (1) (mm)					Snap Ring (1) Dimensions (mm)		Abutment and Fillet Dimensions (mm)					Mass (kg) approx.							
	d	D		B	$r_{min.}$	C_r	C_{0r}	f_0	Grease	Oil	Open	Shielded	Sealed	With Snap Ring Groove	With Snap Ring Groove	a	b	D_1	r_0	r_N	D_2		f	$d_a^{(2)}$	$D_a^{(2)}$	r_a	D_x	C_y	
10	19	5	0.3	1 720	840	14.8	34 000	24 000	40 000	6800	ZZ	VV	DD	—	—	—	—	—	—	—	—	—	12	12	17	0.3	—	—	0.005
	22	6	0.3	2 700	1 270	14.0	32 000	22 000	38 000	6900	ZZ	VV	DD	N ⁽³⁾	NR ⁽³⁾	1.05	0.8	20.8	0.2	0.2	24.8	0.7	12	12.5	20	0.3	25.5	1.5	0.009
	26	8	0.3	4 550	1 970	12.4	30 000	22 000	36 000	6000	ZZ	VV	DDU	N ⁽⁴⁾	NR ⁽⁴⁾	1.35	0.87	24.5	0.2	0.3	28.7	0.84	12	13	24	0.3	29.4	1.9	0.018
	30	9	0.6	5 350	2 390	13.2	28 000	18 000	34 000	* 6200	ZZ	VV	DDU	—	—	—	—	—	—	—	—	—	14	16	26	0.6	—	—	0.032
	30	9	0.6	5 100	2 390	13.2	24 000	18 000	30 000	6200	ZZ	VV	DDU	N	NR	2.06	1.35	28.17	0.4	0.5	34.7	1.12	14	16	26	0.6	35.5	2.9	0.032
	35	11	0.6	8 500	3 450	11.2	26 000	17 000	30 000	* 6300	ZZ	VV	DDU	—	—	—	—	—	—	—	—	—	14	16.5	31	0.6	—	—	0.052
12	21	5	0.3	1 920	1 040	15.3	32 000	20 000	38 000	6801	ZZ	VV	DD	—	—	—	—	—	—	—	—	—	14	14	19	0.3	—	—	0.006
	24	6	0.3	2 890	1 460	14.5	30 000	20 000	36 000	6901	ZZ	VV	DD	N ⁽³⁾	NR ⁽³⁾	1.05	0.8	22.8	0.2	0.2	26.8	0.7	14	14.5	22	0.3	27.5	1.5	0.010
	28	7	0.3	5 100	2 370	13.0	28 000	—	32 000	16001	—	—	—	—	—	—	—	—	—	—	—	14	—	26	0.3	—	—	0.019	
	28	8	0.3	5 350	2 370	13.0	32 000	18 000	38 000	* 6001	ZZ	VV	DDU	—	—	—	—	—	—	—	—	—	14	15.5	26	0.3	—	—	0.022
	28	8	0.3	5 100	2 370	13.0	28 000	18 000	32 000	6001	ZZ	VV	DDU	N ⁽⁴⁾	NR ⁽⁴⁾	1.35	0.87	26.5	0.2	0.3	30.7	0.84	14	15.5	26	0.3	31.4	1.9	0.022
	32	10	0.6	7 150	3 050	12.3	26 000	17 000	32 000	* 6201	ZZ	VV	DDU	—	—	—	—	—	—	—	—	—	16	17	28	0.6	—	—	0.037
	32	10	0.6	6 800	3 050	12.3	22 000	17 000	28 000	6201	ZZ	VV	DDU	N	NR	2.06	1.35	30.15	0.4	0.5	36.7	1.12	16	17	28	0.6	37.5	2.9	0.037
	37	12	1	10 200	4 200	11.1	24 000	16 000	28 000	* 6301	ZZ	VV	DDU	—	—	—	—	—	—	—	—	—	17	18	32	1	—	—	0.060
	37	12	1	9 700	4 200	11.1	20 000	16 000	24 000	6301	ZZ	VV	DDU	N	NR	2.06	1.35	34.77	0.4	0.5	41.3	1.12	17	18	32	1	42	2.9	0.060
	15	24	5	0.3	2 070	1 260	15.8	28 000	17 000	34 000	6802	ZZ	VV	DD	—	—	—	—	—	—	—	—	—	17	17	22	0.3	—	—
28		7	0.3	4 350	2 260	14.3	26 000	17 000	30 000	6902	ZZ	VV	DD	N ⁽³⁾	NR ⁽³⁾	1.30	0.95	26.7	0.25	0.3	30.8	0.85	17	17	26	0.3	31.5	1.8	0.015
32		8	0.3	5 600	2 830	13.9	24 000	—	28 000	16002	—	—	—	—	—	—	—	—	—	—	—	17	—	30	0.3	—	—	0.027	
32		9	0.3	5 850	2 830	13.9	26 000	15 000	32 000	* 6002	ZZ	VV	DDU	—	—	—	—	—	—	—	—	—	17	19	30	0.3	—	—	0.031
32		9	0.3	5 600	2 830	13.9	24 000	15 000	28 000	6002	ZZ	VV	DDU	N	NR	2.06	1.35	30.15	0.4	0.3	36.7	1.12	17	19	30	0.3	37.5	2.9	0.031
35		11	0.6	8 000	3 750	13.2	22 000	14 000	28 000	* 6202	ZZ	VV	DDU	—	—	—	—	—	—	—	—	—	19	20.5	31	0.6	—	—	0.045
35		11	0.6	7 650	3 750	13.2	20 000	14 000	24 000	6202	ZZ	VV	DDU	N	NR	2.06	1.35	33.17	0.4	0.5	39.7	1.12	19	20.5	31	0.6	40.5	2.9	0.045
42		13	1	12 000	5 450	12.3	19 000	13 000	24 000	* 6302	ZZ	VV	DDU	—	—	—	—	—	—	—	—	—	20	22.5	37	1	—	—	0.083
42		13	1	11 400	5 450	12.3	17 000	13 000	20 000	6302	ZZ	VV	DDU	N	NR	2.06	1.35	39.75	0.4	0.5	46.3	1.12	20	22.5	37	1	47	2.9	0.083
17		26	5	0.3	2 630	1 570	15.7	26 000	15 000	30 000	6803	ZZ	VV	DD	—	—	—	—	—	—	—	—	—	19	19	24	0.3	—	—
	30	7	0.3	4 600	2 550	14.7	24 000	15 000	28 000	6903	ZZ	VV	DDU	N ⁽³⁾	NR ⁽³⁾	1.30	0.95	28.7	0.25	0.3	32.8	0.85	19	19.5	28	0.3	33.5	1.8	0.017
	35	8	0.3	6 000	3 250	14.4	22 000	—	26 000	16003	—	—	—	—	—	—	—	—	—	—	—	19	—	33	0.3	—	—	0.033	
	35	10	0.3	6 300	3 250	14.4	24 000	13 000	28 000	* 6003	ZZ	VV	DDU	—	—	—	—	—	—	—	—	—	19	21.5	33	0.3	—	—	0.041
	35	10	0.3	6 000	3 250	14.4	22 000	13 000	26 000	6003	ZZ	VV	DDU	N	NR	2.06	1.35	33.17	0.4	0.3	39.7	1.12	19	21.5	33	0.3	40.5	2.9	0.041
	40	12	0.6	10 100	4 800	13.2	20 000	12 000	24 000	* 6203	ZZ	VV	DDU	—	—	—	—	—	—	—	—	—	21	23.5	36	0.6	—	—	0.067
	40	12	0.6	9 550	4 800	13.2	17 000	12 000	20 000	6203	ZZ	VV	DDU	N	NR	2.06	1.35	38.1	0.4	0.5	44.6	1.12	21	23.5	36	0.6	45.5	2.9	0.067
	47	14	1	14 300	6 650	12.4	17 000	11 000	20 000	* 6303	ZZ	VV	DDU	—	—	—	—	—	—	—	—	—	22	25.5	42	1	—	—	0.113
	47	14	1	13 600	6 650	12.4	15 000	11 000	18 000	6303	ZZ	VV	DDU	N	NR	2.46	1.35	44.6	0.4	0.5	52.7	1.12	22	25.5	42	1	53.5	3.3	0.113

- Notes** (1) For tolerances of snap ring grooves and snap ring dimensions, refer to Pages A116 to A119.
 (2) When heavy axial loads are applied, d_a and D_a can be adjusted up to the shoulder diameter of the races. Please consult NSK for details.
 (3) Ring types N and NR are applicable only to open bearings. Please consult NSK about the snap ring groove dimensions of sealed or shielded bearings.
 (4) Snap ring groove dimensions and snap ring dimensions do not conform to ISO15.

- Remarks** 1. Diameter Series 7 (extra-thin wall) bearings are also available; please contact NSK for details.
 2. When using bearings with rotating outer rings, contact NSK if they are sealed, shielded, or have snap rings.
 3. Bearings denoted by an asterisk (*) are NSKHPS™ deep groove ball bearings.

SINGLE-ROW DEEP GROOVE BALL BEARINGS

Bore Diameter 20 – 30 mm

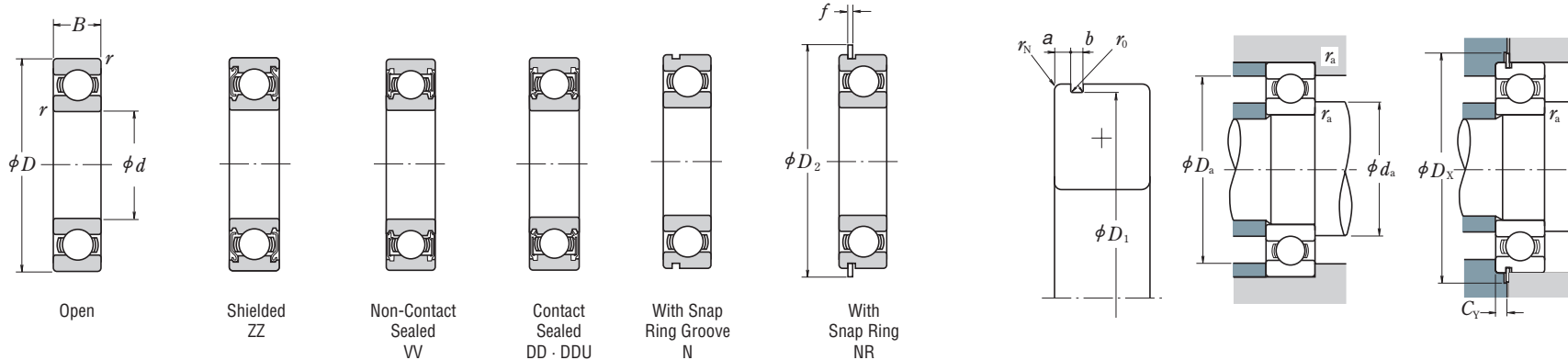

Dynamic Equivalent Load

$$P = X F_r + Y F_a$$

$\frac{f_0 F_a}{C_{0r}}$	e	$\frac{F_a}{F_r} \leq e$		$\frac{F_a}{F_r} > e$	
		X	Y	X	Y
		0.172	0.19	1	0
0.345	0.22	1	0	0.56	1.99
0.689	0.26	1	0	0.56	1.71
1.03	0.28	1	0	0.56	1.55
1.38	0.30	1	0	0.56	1.45
2.07	0.34	1	0	0.56	1.31
3.45	0.38	1	0	0.56	1.15
5.17	0.42	1	0	0.56	1.04
6.89	0.44	1	0	0.56	1.00

Static Equivalent Load

$$\frac{F_a}{F_r} > 0.8, P_0 = 0.6 F_r + 0.5 F_a$$

$$\frac{F_a}{F_r} \leq 0.8, P_0 = F_r$$

Boundary Dimensions (mm)				Basic Load Ratings (N)		Factor	Limiting Speeds (min ⁻¹)			Bearing Designations			Snap Ring Groove Dimensions (1) (mm)					Snap Ring (1) Dimensions (mm)		Abutment and Fillet Dimensions (mm)					Mass (kg)				
d	D	B	r min.	C _r	C _{0r}	f ₀	Grease		Oil	Open	Shielded	Sealed	a max.	b min.	D ₁ max.	r ₀ max.	r _N min.	D ₂ max.	f max.	d _a (2) min.	d _a (2) max.	D _a (2) max.	r _a max.	D _x min.	C _γ max.	approx.			
							Open Z	ZZ	DU	Open Z																			
20	32	7	0.3	4 000	2 470	15.5	22 000	13 000	26 000																		0.017		
	37	9	0.3	6 400	3 700	14.7	19 000	12 000	22 000																		0.037		
	42	8	0.3	7 900	4 450	14.5	18 000	—	20 000																		0.048		
	42	12	0.6	9 850	5 000	13.8	20 000	11 000	24 000																		0.068		
	42	12	0.6	9 400	5 000	13.8	18 000	11 000	20 000																		0.068		
	47	14	1	13 400	6 600	13.1	17 000	11 000	20 000																			0.107	
	47	14	1	12 800	6 600	13.1	15 000	11 000	18 000																			0.107	
	52	15	1.1	16 700	7 900	12.4	16 000	10 000	19 000																			0.145	
	52	15	1.1	15 900	7 900	12.4	14 000	10 000	17 000																			0.145	
	22	44	12	0.6	9 400	5 050	14.0	17 000	11 000	20 000																			0.074
50		14	1	12 900	6 800	13.5	14 000	9 500	16 000																			0.119	
56		16	1.1	18 400	9 250	12.4	13 000	9 500	16 000																			0.179	
44		12	0.6	9 400	5 050	14.0	17 000	11 000	20 000																			0.074	
50		14	1	12 900	6 800	13.5	14 000	9 500	16 000																			0.119	
56		16	1.1	18 400	9 250	12.4	13 000	9 500	16 000																			0.179	
25	37	7	0.3	4 500	3 150	16.1	18 000	10 000	22 000																			0.021	
	42	9	0.3	7 050	4 550	15.4	16 000	10 000	19 000																			0.042	
	47	8	0.3	8 850	5 600	15.1	15 000	—	18 000																			0.059	
	47	12	0.6	10 600	5 850	14.5	18 000	9 500	22 000																			0.079	
	47	12	0.6	10 100	5 850	14.5	15 000	9 500	18 000																			0.079	
	52	15	1	14 700	7 850	13.9	15 000	9 000	18 000																			0.129	
	52	15	1	14 000	7 850	13.9	13 000	9 000	15 000																			0.129	
	62	17	1.1	21 600	11 200	13.2	13 000	8 000	16 000																				0.235
	62	17	1.1	20 600	11 200	13.2	11 000	8 000	13 000																				0.235
	28	52	12	0.6	12 500	7 400	14.5	14 000	8 500	16 000																			0.096
58		16	1	16 600	9 500	13.9	12 000	8 000	14 000																			0.175	
68		18	1.1	26 700	14 000	12.4	10 000	7 500	13 000																			0.287	
52		12	0.6	12 500	7 400	14.5	14 000	8 500	16 000																			0.096	
30	42	7	0.3	4 700	3 650	16.4	15 000	9 000	18 000																			0.024	
	47	9	0.3	7 250	5 000	15.8	14 000	8 500	17 000																			0.052	
	55	9	0.3	11 200	7 350	15.2	13 000	—	15 000																			0.087	
	55	13	1	13 900	8 300	14.7	15 000	8 000	18 000																			0.116	
	55	13	1	13 200	8 300	14.7	13 000	8 000	15 000																			0.116	
	62	16	1	20 400	11 300	13.8	12 000	7 500	15 000																			0.199	
	62	16	1	19 500	11 300	13.8	11 000	7 500	13 000																			0.199	
	72	19	1.1	28 000	15 000	13.3	11 000	6 700	13 000																			0.345	
	72	19	1.1	26 700	15 000	13.3	9 500	6 700	12 000																				0.345

- Notes** (1) For tolerances of snap ring grooves and snap ring dimensions, refer to Pages A116 to A119.
 (2) When heavy axial loads are applied, d_a and D_a can be adjusted up to the shoulder diameter of the races. Please consult NSK for details.
 (3) Ring types N and NR are applicable only to open bearings. Please consult NSK about the snap ring groove dimensions of sealed or shielded bearings.

- Remarks** 1. Diameter Series 7 (extra-thin wall) bearings are also available; please contact NSK for details.
 2. When using bearings with rotating outer rings, contact NSK if they are sealed, shielded, or have snap rings.
 3. Bearings denoted by an asterisk (*) are NSKHPS™ deep groove ball bearings.

■ SINGLE-ROW DEEP GROOVE BALL BEARINGS

Bore Diameter 32 – 45 mm

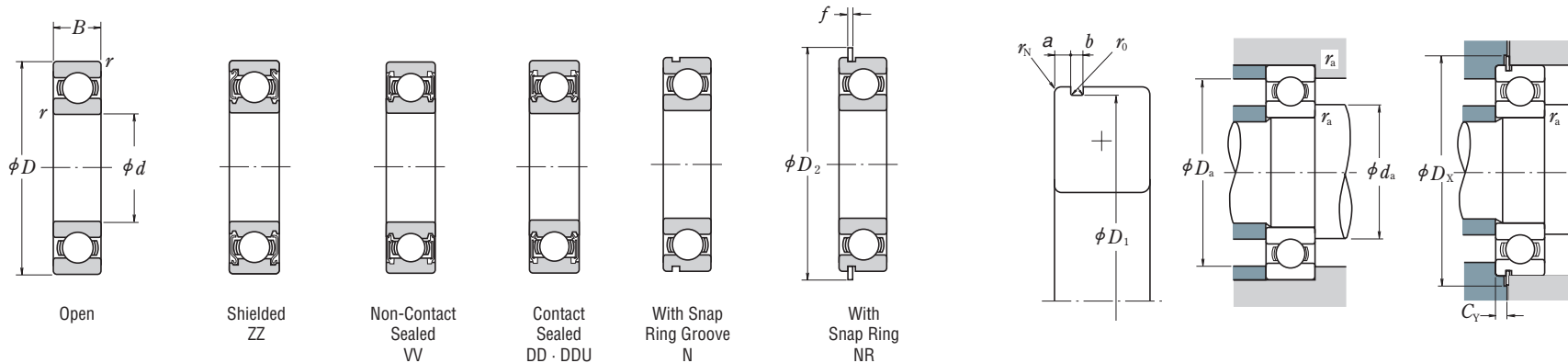

Dynamic Equivalent Load

$$P = XF_r + YF_a$$

$\frac{f_0 F_a}{C_{0r}}$	e	$\frac{F_a}{F_r} \leq e$		$\frac{F_a}{F_r} > e$	
		X	Y	X	Y
0.172	0.19	1	0	0.56	2.30
0.345	0.22	1	0	0.56	1.99
0.689	0.26	1	0	0.56	1.71
1.03	0.28	1	0	0.56	1.55
1.38	0.30	1	0	0.56	1.45
2.07	0.34	1	0	0.56	1.31
3.45	0.38	1	0	0.56	1.15
5.17	0.42	1	0	0.56	1.04
6.89	0.44	1	0	0.56	1.00

Static Equivalent Load

$$\frac{F_a}{F_r} > 0.8, P_0 = 0.6F_r + 0.5F_a$$

$$\frac{F_a}{F_r} \leq 0.8, P_0 = F_r$$

Boundary Dimensions (mm)				Basic Load Ratings (N)		Factor	Limiting Speeds (min ⁻¹)			Bearing Designations			Snap Ring Groove Dimensions (1) (mm)		Snap Ring (1) Dimensions (mm)		Abutment and Fillet Dimensions (mm)					Mass (kg)								
d	D	B	r min.	C_r	C_{0r}	f_0	Grease		Oil	Open	Shielded	Sealed	a max.	b min.	D_1 max.	r_0 max.	r_N min.	D_2 max.	f max.	d_a (2) min.	d_a (2) max.	D_a (2) max.	r_a max.	D_x min.	C_Y max.	approx.				
32	58	13	1	15 100	9 150	14.5	12 000	7 500	14 000	60/32	ZZ	VV	DDU	N	NR	2.08	1.35	55.6	0.4	0.5	63.7	1.12	37	38.5	53	1	64.5	2.9	0.122	
	65	17	1	20 700	11 600	13.6	10 000	7 100	12 000	62/32	ZZ	VV	DDU	N	NR	3.28	1.9	62.6	0.6	0.5	70.7	1.7	37	40	60	1	71.5	4.6	0.225	
	75	20	1.1	29 900	17 000	13.2	9 000	6 300	11 000	63/32	ZZ	VV	DDU	N	NR	3.28	1.9	71.83	0.6	0.5	81.6	1.7	38.5	44.5	68.5	1	83	4.6	0.389	
35	47	7	0.3	4 900	4 100	16.7	14 000	7 500	16 000	6807	ZZ	VV	DD	N	NR	1.30	0.95	45.7	0.25	0.3	49.8	0.85	37	37	45	0.3	50.5	1.8	0.027	
	55	10	0.6	10 600	7 250	15.5	12 000	7 500	15 000	6907	ZZ	VV	DDU	N	NR	1.70	0.95	53.7	0.25	0.5	57.8	0.85	39	39	51	0.6	58.5	2.3	0.075	
	62	9	0.3	11 700	8 200	15.6	11 000	—	13 000	16007	—	—	—	—	—	—	—	—	—	—	—	—	—	—	—	—	—	—	0.107	
	62	14	1	16 800	10 300	14.8	13 000	6 700	15 000	* 6007	ZZ	VV	DDU	—	—	—	—	—	—	—	—	—	40	41.5	57	1	—	—	—	0.151
	62	14	1	16 000	10 300	14.8	11 000	6 700	13 000	6007	ZZ	VV	DDU	N	NR	2.08	1.9	59.61	0.6	0.5	67.7	1.7	40	41.5	57	1	68.5	3.4	0.151	
	72	17	1.1	27 000	15 300	13.8	11 000	6 300	13 000	* 6207	ZZ	VV	DDU	—	—	—	—	—	—	—	—	—	41.5	44.5	65.5	1	—	—	—	0.284
40	72	17	1.1	25 700	15 300	13.8	9 500	6 300	11 000	6207	ZZ	VV	DDU	N	NR	3.28	1.9	68.81	0.6	0.5	78.6	1.7	41.5	44.5	65.5	1	80	4.6	0.284	
	80	21	1.5	35 000	19 200	13.2	10 000	6 000	12 000	* 6307	ZZ	VV	DDU	—	—	—	—	—	—	—	—	43	47	72	1.5	—	—	—	0.464	
	80	21	1.5	33 500	19 200	13.2	8 500	6 000	10 000	6307	ZZ	VV	DDU	N	NR	3.28	1.9	76.81	0.6	0.5	86.6	1.7	43	47	72	1.5	88	4.6	0.464	
	52	7	0.3	6 350	5 550	17.0	12 000	6 700	14 000	6808	ZZ	VV	DD	N	NR	1.30	0.95	50.7	0.25	0.3	54.8	0.85	42	42	50	0.3	55.5	1.8	0.031	
	62	12	0.6	13 700	10 000	15.7	11 000	6 300	13 000	6908	ZZ	VV	DDU	N	NR	1.70	0.95	60.7	0.25	0.5	64.8	0.85	44	46	58	0.6	65.5	2.3	0.112	
	68	9	0.3	12 600	9 650	16.0	10 000	—	12 000	16008	—	—	—	—	—	—	—	—	—	—	—	—	—	—	—	—	—	—	0.13	
45	68	15	1	17 600	11 500	15.3	12 000	6 000	14 000	* 6008	ZZ	VV	DDU	—	—	—	—	—	—	—	—	—	45	47.5	63	1	—	—	—	0.19
	68	15	1	16 800	11 500	15.3	10 000	6 000	12 000	6008	ZZ	VV	DDU	N	NR	2.49	1.9	64.82	0.6	0.5	74.6	1.7	45	47.5	63	1	76	3.8	0.19	
	80	18	1.1	30 500	17 900	14.0	9 500	5 600	12 000	* 6208	ZZ	VV	DDU	—	—	—	—	—	—	—	—	46.5	50.5	73.5	1	—	—	—	0.366	
	80	18	1.1	29 100	17 900	14.0	8 500	5 600	10 000	6208	ZZ	VV	DDU	N	NR	3.28	1.9	76.81	0.6	0.5	86.6	1.7	46.5	50.5	73.5	1	88	4.6	0.366	
	90	23	1.5	43 000	24 000	13.2	9 000	5 300	11 000	* 6308	ZZ	VV	DDU	—	—	—	—	—	—	—	—	—	48	53	82	1.5	—	—	—	0.636
	90	23	1.5	40 500	24 000	13.2	7 500	5 300	9 000	6308	ZZ	VV	DDU	N	NR	3.28	2.7	86.79	0.6	0.5	96.5	2.46	48	53	82	1.5	98	5.4	0.636	
45	58	7	0.3	6 600	6 150	17.2	11 000	6 000	13 000	6809	ZZ	VV	DD	N	NR	1.30	0.95	56.7	0.25	0.3	60.8	0.85	47	47.5	56	0.3	61.5	1.8	0.038	
	68	12	0.6	14 100	10 900	15.9	9 500	5 600	12 000	6909	ZZ	VV	DDU	N	NR	1.70	0.95	66.7	0.25	0.3(3)	70.8	0.85	49	50	64	0.6	72	2.3	0.126	
	75	10	0.6	14 900	11 400	15.9	9 000	—	11 000	16009	—	—	—	—	—	—	—	—	—	—	—	—	—	—	—	—	—	—	0.167	
	75	16	1	22 000	15 200	15.3	10 000	5 300	12 000	* 6009	ZZ	VV	DDU	—	—	—	—	—	—	—	—	—	50	53.5	70	1	—	—	—	0.241
	75	16	1	20 900	15 200	15.3	9 000	5 300	11 000	6009	ZZ	VV	DDU	N	NR	2.49	1.9	71.83	0.6	0.5	81.6	1.7	50	53.5	70	1	83	3.8	0.241	
	85	19	1.1	33 000	20 400	14.4	9 000	5 300	11 000	* 6209	ZZ	VV	DDU	—	—	—	—	—	—	—	—	—	51.5	55.5	78.5	1	—	—	—	0.42
45	85	19	1.1	31 500	20 400	14.4	7 500	5 300	9 000	6209	ZZ	VV	DDU	N	NR	3.28	1.9	81.81	0.6	0.5	91.6	1.7	51.5	55.5	78.5	1	93	4.6	0.42	
	100	25	1.5	55 500	32 000	13.1	7 500	4 800	9 500	* 6309	ZZ	VV	DDU	—	—	—	—	—	—	—	—	53	61.5	92	1.5	—	—	—	0.829	
	100	25	1.5	53 000	32 000	13.1	6 700	4 800	8 000	6309	ZZ	VV	DDU	N	NR	3.28	2.7	96.8	0.6	0.5	106.5	2.46	53	61.5	92	1.5	108	5.4	0.829	

- Notes** (1) For tolerances of snap ring grooves and snap ring dimensions, refer to Pages A116 to A119.
 (2) When heavy axial loads are applied, d_a and D_a can be adjusted up to the shoulder diameter of the races. Please consult NSK for details.
 (3) Does not conform to ISO15.

- Remarks** 1. Diameter Series 7 (extra-thin wall) bearings are also available; please contact NSK for details.
 2. When using bearings with rotating outer rings, contact NSK if they are sealed, shielded, or have snap rings.
 3. Bearings denoted by an asterisk (*) are NSKHPS™ deep groove ball bearings.

SINGLE-ROW DEEP GROOVE BALL BEARINGS

Bore Diameter 50 – 60 mm

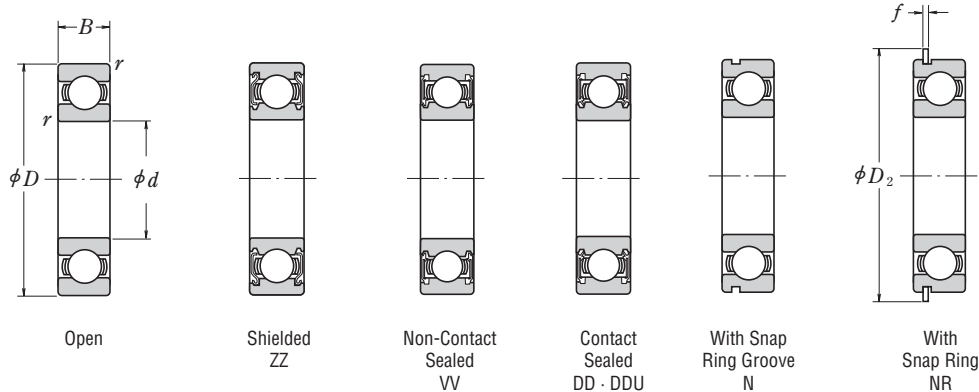

Dynamic Equivalent Load

$$P = XF_r + YF_a$$

$\frac{f_0 F_a}{C_{0r}}$	e	$\frac{F_a}{F_r} \leq e$		$\frac{F_a}{F_r} > e$	
		X	Y	X	Y
0.172	0.19	1	0	0.56	2.30
0.345	0.22	1	0	0.56	1.99
0.689	0.26	1	0	0.56	1.71
1.03	0.28	1	0	0.56	1.55
1.38	0.30	1	0	0.56	1.45
2.07	0.34	1	0	0.56	1.31
3.45	0.38	1	0	0.56	1.15
5.17	0.42	1	0	0.56	1.04
6.89	0.44	1	0	0.56	1.00

Static Equivalent Load

$$\frac{F_a}{F_r} > 0.8, P_0 = 0.6F_r + 0.5F_a$$

$$\frac{F_a}{F_r} \leq 0.8, P_0 = F_r$$

Boundary Dimensions (mm)	Basic Load Ratings (N)		Factor f_0	Limiting Speeds (min ⁻¹)			Bearing Designations			With Snap Ring Groove	With Snap Ring	Snap Ring Groove Dimensions (1) (mm)					Snap Ring (1) Dimensions (mm)		Abutment and Fillet Dimensions (mm)					Mass (kg) approx.						
	d	D		B	$r_{min.}$	C_r	C_{0r}	Grease	Oil			Open	Shielded	Sealed	a	b	D_1	r_0	r_N	D_2	f	$d_a^{(2)}$	$D_a^{(2)}$		r_a	D_x	C_Y			
50	65	7	0.3	6 400	6 200	17.2	9 500	5 300	11 000	6810	ZZ	VV	DDU	N	NR	1.30	0.95	63.7	0.25	0.3	67.8	0.85	52	52.5	63	0.3	68.5	1.8	0.050	
	72	12	0.6	14 500	11 700	16.1	9 000	5 300	11 000	6910	ZZ	VV	DDU	N	NR	1.70	0.95	70.7	0.25	0.5	74.8	0.85	54	55	68	0.6	76	2.3	0.135	
	80	10	0.6	15 400	12 400	16.1	8 500	—	10 000	16010	—	—	—	—	—	—	—	—	—	—	—	—	54	—	76	0.6	—	—	0.175	
	80	16	1	22 900	16 600	15.6	9 500	4 800	11 000	* 6010	ZZ	VV	DDU	—	—	—	—	—	—	—	—	—	55	58.5	75	1	—	—	0.261	
	80	16	1	21 800	16 600	15.6	8 500	4 800	10 000	6010	ZZ	VV	DDU	N	NR	2.49	1.9	76.81	0.6	0.5	86.6	1.7	55	58.5	75	1	88	3.8	0.261	
	80	20	1.1	37 000	23 200	14.4	8 000	4 800	10 000	* 6210	ZZ	VV	DDU	—	—	—	—	—	—	—	—	—	56.5	60	83.5	1	—	—	0.459	
	90	20	1.1	35 000	23 200	14.4	7 100	4 800	8 500	* 6210	ZZ	VV	DDU	N	NR	3.28	2.7	86.79	0.6	0.5	96.5	2.46	56.5	60	83.5	1	98	5.4	0.459	
	110	27	2	65 000	38 500	13.2	7 100	4 300	8 500	* 6310	ZZ	VV	DDU	—	—	—	—	—	—	—	—	—	59	68	101	2	—	—	1.06	
	110	27	2	62 000	38 500	13.2	6 000	4 300	7 500	6310	ZZ	VV	DDU	N	NR	3.28	2.7	106.81	0.6	0.5	116.6	2.46	59	68	101	2	118	5.4	1.06	
	55	72	9	0.3	8 800	8 500	17.0	8 500	4 800	10 000	6811	ZZ	VV	DDU	N	NR	1.70	0.95	70.7	0.25	0.3	74.8	0.85	57	59	70	0.3	76	2.3	0.081
		80	13	1	16 000	13 300	16.2	8 000	4 500	9 500	6911	ZZ	VV	DDU	N	NR	2.10	1.3	77.9	0.4	0.5	84.4	1.12	60	61.5	75	1	86	2.9	0.189
		90	11	0.6	19 400	16 300	16.2	7 500	—	9 000	16011	—	—	—	—	—	—	—	—	—	—	—	59	—	86	0.6	—	—	0.257	
90		18	1.1	29 700	21 200	15.3	8 500	4 500	10 000	* 6011	ZZ	VV	DDU	—	—	—	—	—	—	—	—	—	61.5	64	83.5	1	—	—	0.381	
90		18	1.1	28 300	21 200	15.3	7 500	4 500	9 000	6011	ZZ	VV	DDU	N	NR	2.87	2.7	86.79	0.6	0.5	96.5	2.46	61.5	64	83.5	1	98	5	0.381	
100		21	1.5	45 500	29 300	14.3	7 500	4 300	9 000	* 6211	ZZ	VV	DDU	—	—	—	—	—	—	—	—	—	63	66.5	92	1.5	—	—	0.619	
100		21	1.5	43 500	29 300	14.3	6 300	4 300	7 500	* 6211	ZZ	VV	DDU	N	NR	3.28	2.7	96.8	0.6	0.5	106.5	2.46	63	66.5	92	1.5	108	5.4	0.619	
120		29	2	75 000	44 500	13.1	6 700	4 000	8 000	* 6311	ZZ	VV	DDU	—	—	—	—	—	—	—	—	—	64	72.5	111	2	—	—	1.37	
120		29	2	71 500	44 500	13.1	5 600	4 000	6 700	6311	ZZ	VV	DDU	N	NR	4.06	3.1	115.21	0.6	0.5	129.7	2.82	64	72.5	111	2	131.5	6.5	1.37	
60		78	10	0.3	11 500	10 900	16.9	8 000	4 500	9 500	6812	ZZ	VV	DD	N	NR	1.70	1.3	76.2	0.4	0.3	82.7	1.12	62	64	76	0.3	84	2.5	0.103
		85	13	1	19 400	16 300	16.2	7 500	4 300	9 000	6912	ZZ	VV	DDU	N	NR	2.10	1.3	82.9	0.4	0.5	89.4	1.12	65	66	80	1	91	2.9	0.192
		95	11	0.6	20 000	17 500	16.3	7 100	—	8 500	16012	—	—	—	—	—	—	—	—	—	—	—	64	—	91	0.6	—	—	0.281	
	95	18	1.1	31 000	23 200	15.6	8 000	4 000	9 500	* 6012	ZZ	VV	DDU	—	—	—	—	—	—	—	—	—	66.5	69	88.5	1	—	—	0.412	
	95	18	1.1	29 500	23 200	15.6	7 100	4 000	8 500	6012	ZZ	VV	DDU	N	NR	2.87	2.7	91.82	0.6	0.5	101.6	2.46	66.5	69	88.5	1	103	5	0.412	
	110	22	1.5	55 000	36 000	14.3	6 700	3 800	8 000	* 6212	ZZ	VV	DDU	—	—	—	—	—	—	—	—	—	68	74.5	102	1.5	—	—	0.783	
	110	22	1.5	52 500	36 000	14.3	5 600	3 800	7 100	* 6212	ZZ	VV	DDU	N	NR	3.28	2.7	106.81	0.6	0.5	116.6	2.46	68	74.5	102	1.5	118	5.4	0.783	
	130	31	2.1	86 000	52 000	13.1	6 000	3 600	7 100	* 6312	ZZ	VV	DDU	—	—	—	—	—	—	—	—	—	71	79	119	2	—	—	1.72	
	130	31	2.1	82 000	52 000	13.1	5 300	3 600	6 300	6312	ZZ	VV	DDU	N	NR	4.06	3.1	125.22	0.6	0.5	139.7	2.82	71	79	119	2	141.5	6.5	1.72	

Notes (1) For tolerances of snap ring grooves and snap ring dimensions, refer to Pages A116 to A119.
 (2) When heavy axial loads are applied, d_a and D_a can be adjusted up to the shoulder diameter of the races. Please consult NSK for details.

Remarks 1. Diameter Series 7 (extra-thin wall) bearings are also available; please contact NSK for details.
 2. When using bearings with rotating outer rings, contact NSK if they are sealed, shielded, or have snap rings.
 3. Please consult NSK about the snap ring groove dimensions of Dimension Series 18 and 19 sealed and shielded bearings when the diameter is 50 mm or more.
 4. Bearings denoted by an asterisk (*) are NSKHPST™ deep groove ball bearings.

SINGLE-ROW DEEP GROOVE BALL BEARINGS

Bore Diameter 65 – 75 mm

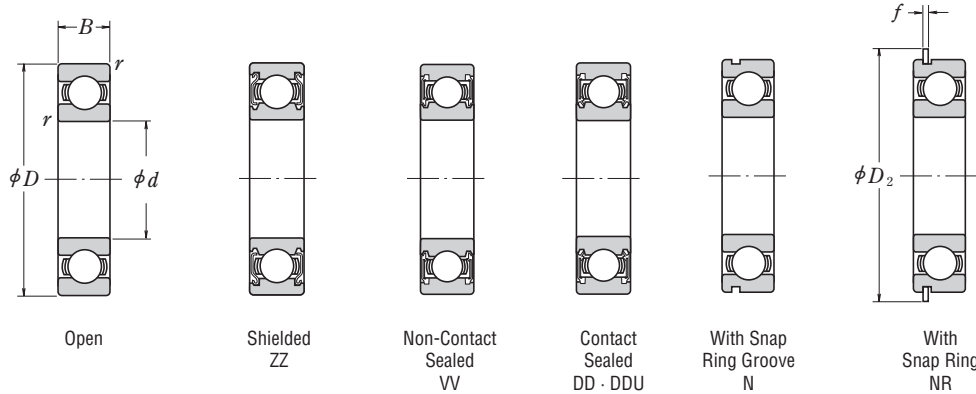

Dynamic Equivalent Load

$$P = XF_r + YF_a$$

$\frac{f_0 F_a}{C_{0r}}$	e	$\frac{F_a}{F_r} \leq e$		$\frac{F_a}{F_r} > e$	
		X	Y	X	Y
0.172	0.19	1	0	0.56	2.30
0.345	0.22	1	0	0.56	1.99
0.689	0.26	1	0	0.56	1.71
1.03	0.28	1	0	0.56	1.55
1.38	0.30	1	0	0.56	1.45
2.07	0.34	1	0	0.56	1.31
3.45	0.38	1	0	0.56	1.15
5.17	0.42	1	0	0.56	1.04
6.89	0.44	1	0	0.56	1.00

Static Equivalent Load

$$\frac{F_a}{F_r} > 0.8, P_0 = 0.6F_r + 0.5F_a$$

$$\frac{F_a}{F_r} \leq 0.8, P_0 = F_r$$

Boundary Dimensions (mm)	Basic Load Ratings (N)		Factor f_0	Limiting Speeds (min ⁻¹)			Bearing Designations			With Snap Ring Groove	With Snap Ring	Snap Ring Groove Dimensions (1) (mm)					Snap Ring (1) Dimensions (mm)		Abutment and Fillet Dimensions (mm)					Mass (kg) approx.		
	d	D		B	$r_{min.}$	C_r	C_{0r}	Grease	Oil			Open	Shielded	Sealed	a	b	D_1	r_0	r_N	D_2	f	d_a (2)	D_a (2)		r_a	D_x
65	85	10	0.6	11 900	12 100	17.0	7 500	4 000	8 500	6813 ZZ VV DD	N	NR	1.70	1.3	82.9	0.4	0.5	89.4	1.12	69	69	81	0.6	91	2.5	0.128
	90	13	1	17 400	16 100	16.6	7 100	4 000	8 500	6913 ZZ VV DDU	N	NR	2.10	1.3	87.9	0.4	0.5	94.4	1.12	70	71.5	85	1	96	2.9	0.218
	100	11	0.6	20 500	18 700	16.5	6 700	—	8 000	16013 — — —	—	—	—	—	—	—	—	—	69	—	96	0.6	—	—	0.30	
100	18	1.1	32 000	25 200	15.8	7 500	4 000	9 000	* 6013 ZZ VV DDU	—	—	—	—	—	—	—	—	—	71.5	73	93.5	1	—	—	0.439	
	100	18	1.1	30 500	25 200	15.8	6 700	4 000	8 000	6013 ZZ VV DDU	N	NR	2.87	2.7	96.8	0.6	0.5	106.5	2.46	71.5	73	93.5	1	108	5	0.439
	120	23	1.5	60 000	40 000	14.4	6 300	3 600	7 500	* 6213 ZZ VV DDU	—	—	—	—	—	—	—	—	73	80	112	1.5	—	—	1.0	
120	23	1.5	57 500	40 000	14.4	5 300	3 600	6 300	* 6213 ZZ VV DDU	N	NR	4.06	3.1	115.21	0.6	0.5	129.7	2.82	73	80	112	1.5	131.5	6.5	1.0	
	140	33	2.1	97 500	60 000	13.2	5 600	3 400	6 700	* 6313 ZZ VV DDU	—	—	—	—	—	—	—	—	76	85.5	129	2	—	—	2.11	
	140	33	2.1	92 500	60 000	13.2	4 800	3 400	6 000	6313 ZZ VV DDU	N	NR	4.90	3.1	135.23	0.6	0.5	149.7	2.82	76	85.5	129	2	152	7.3	2.11
70	90	10	0.6	12 100	12 700	17.2	6 700	3 800	8 000	6814 ZZ VV DD	N	NR	1.70	1.3	87.9	0.4	0.5	94.4	1.12	74	74.5	86	0.6	96	2.5	0.134
	100	16	1	23 700	21 200	16.3	6 300	3 600	7 500	6914 ZZ VV DDU	N	NR	2.50	1.3	97.9	0.4	0.5	104.4	1.12	75	77.5	95	1	106	3.3	0.349
	110	13	0.6	26 800	23 600	16.3	6 000	—	7 100	16014 — — —	—	—	—	—	—	—	—	—	74	—	106	0.6	—	—	0.441	
110	20	1.1	40 000	31 000	15.6	7 100	3 600	8 500	* 6014 ZZ VV DDU	—	—	—	—	—	—	—	—	—	76.5	80.5	103.5	1	—	—	0.608	
	110	20	1.1	38 000	31 000	15.6	6 000	3 600	7 100	6014 ZZ VV DDU	N	NR	2.87	2.7	106.81	0.6	0.5	116.6	2.46	76.5	80.5	103.5	1	118	5	0.608
	125	24	1.5	65 500	44 000	14.5	6 000	3 400	7 100	* 6214 ZZ VV DDU	—	—	—	—	—	—	—	—	78	84	117	1.5	—	—	1.09	
125	24	1.5	62 000	44 000	14.5	5 000	3 400	6 300	* 6214 ZZ VV DDU	N	NR	4.06	3.1	120.22	0.6	0.5	134.7	2.82	78	84	117	1.5	136.5	6.5	1.09	
	150	35	2.1	109 000	68 000	13.2	5 300	3 200	6 300	* 6314 ZZ VV DDU	—	—	—	—	—	—	—	—	81	92	139	2	—	—	2.57	
	150	35	2.1	104 000	68 000	13.2	4 500	3 200	5 300	6314 ZZ VV DDU	N	NR	4.90	3.1	145.24	0.6	0.5	159.7	2.82	81	92	139	2	162	7.3	2.57
75	95	10	0.6	12 500	13 900	17.3	6 300	3 600	7 500	6815 ZZ VV DDU	N	NR	1.70	1.3	92.9	0.4	0.5	99.4	1.12	79	79.5	91	0.6	101	2.5	0.149
	105	16	1	24 400	22 600	16.5	6 000	3 400	7 100	6915 ZZ VV DDU	N	NR	2.50	1.3	102.6	0.4	0.5	110.7	1.12	80	82	100	1	112	3.3	0.364
	115	13	0.6	27 600	25 300	16.4	5 600	—	6 700	16015 — — —	—	—	—	—	—	—	—	—	79	—	111	0.6	—	—	0.463	
115	20	1.1	41 500	33 500	15.8	6 700	3 400	8 000	* 6015 ZZ VV DDU	—	—	—	—	—	—	—	—	—	81.5	85.5	108.5	1	—	—	0.649	
	115	20	1.1	39 500	33 500	15.8	5 600	3 400	6 700	6015 ZZ VV DDU	N	NR	2.87	2.7	111.81	0.6	0.5	121.6	2.46	81.5	85.5	108.5	1	123	5	0.649
	130	25	1.5	69 500	49 500	14.7	5 600	3 200	6 700	* 6215 ZZ VV DDU	—	—	—	—	—	—	—	—	83	90	122	1.5	—	—	1.19	
130	25	1.5	66 000	49 500	14.7	4 800	3 200	5 600	* 6215 ZZ VV DDU	N	NR	4.06	3.1	125.22	0.6	0.5	139.7	2.82	83	90	122	1.5	141.5	6.5	1.19	
	160	37	2.1	119 000	77 000	13.2	4 800	2 800	6 000	* 6315 ZZ VV DDU	—	—	—	—	—	—	—	—	86	98.5	149	2	—	—	3.08	
	160	37	2.1	113 000	77 000	13.2	4 300	2 800	5 000	6315 ZZ VV DDU	N	NR	4.90	3.1	155.22	0.6	0.5	169.7	2.82	86	98.5	149	2	172	7.3	3.08

Notes (1) For tolerances of snap ring grooves and snap ring dimensions, refer to Pages A116 to A119.
 (2) When heavy axial loads are applied, d_a and D_a can be adjusted up to the shoulder diameter of the races. Please consult NSK for details.

Remarks 1. Diameter Series 7 (extra-thin wall) bearings are also available; please contact NSK for details.
 2. When using bearings with rotating outer rings, contact NSK if they are sealed, shielded, or have snap rings.
 3. Please consult NSK about the snap ring groove dimensions of Dimension Series 18 and 19 sealed and shielded bearings when the diameter is 50 mm or more.
 4. Bearings denoted by an asterisk (*) are NSKHPST™ deep groove ball bearings.

SINGLE-ROW DEEP GROOVE BALL BEARINGS

Bore Diameter 80 – 90 mm

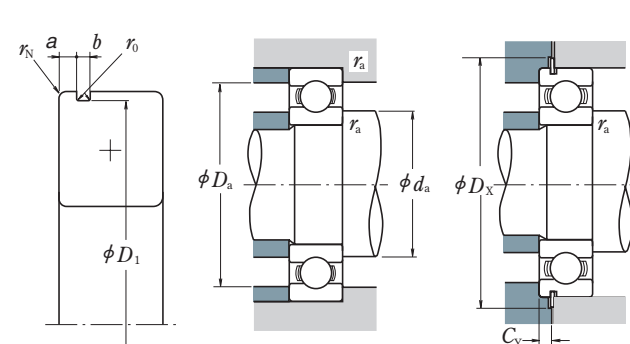
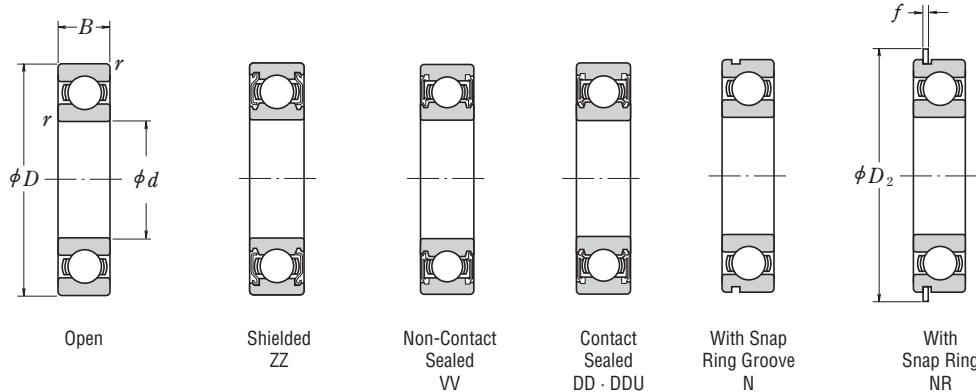

Dynamic Equivalent Load

$$P = XF_r + YF_a$$

$\frac{f_0 F_a}{C_{0r}}$	e	$\frac{F_a}{F_r} \leq e$		$\frac{F_a}{F_r} > e$	
		X	Y	X	Y
0.172	0.19	1	0	0.56	2.30
0.345	0.22	1	0	0.56	1.99
0.689	0.26	1	0	0.56	1.71
1.03	0.28	1	0	0.56	1.55
1.38	0.30	1	0	0.56	1.45
2.07	0.34	1	0	0.56	1.31
3.45	0.38	1	0	0.56	1.15
5.17	0.42	1	0	0.56	1.04
6.89	0.44	1	0	0.56	1.00

Static Equivalent Load

$$\frac{F_a}{F_r} > 0.8, P_0 = 0.6F_r + 0.5F_a$$

$$\frac{F_a}{F_r} \leq 0.8, P_0 = F_r$$

Boundary Dimensions (mm)	Basic Load Ratings (N)		Factor	Limiting Speeds (min ⁻¹)			Bearing Designations			Snap Ring Groove Dimensions (1)					Snap Ring (1) Dimensions (mm)		Abutment and Fillet Dimensions (mm)					Mass (kg)			
										Greas		Oil	a	b	D ₁	r ₀	r _N	D ₂	f	d _a (2)	D _a (2)		r _a	D _x	C _y
										Open Z	ZZ	DU													
80	100	10	0.6	12 700	14 500	17.4	6 000	3 400	7 100	6816 ZZ VV DDU	N NR	1.7	1.3	97.9	0.4	0.5	104.4	1.12	84	84.5	96	0.6	106	2.5	0.151
	110	16	1	25 000	24 000	16.6	5 600	3 200	6 700	6916 ZZ VV DDU	N NR	2.5	1.3	107.6	0.4	0.5	115.7	1.12	85	87.5	105	1	117	3.3	0.391
	125	14	0.6	32 000	29 600	16.4	5 300	—	6 300	16016	—	—	—	—	—	—	—	—	84	—	121	0.6	—	—	0.621
	125	22	1.1	50 000	40 000	15.6	6 300	3 200	7 100	* 6016 ZZ VV DDU	—	—	—	—	—	—	—	—	86.5	91	118.5	1	—	—	0.872
	125	22	1.1	47 500	40 000	15.6	5 300	3 200	6 300	6016 ZZ VV DDU	N NR	2.87	3.1	120.22	0.6	0.5	134.7	2.82	86.5	91	118.5	1	136.5	5.3	0.872
	140	26	2	76 500	53 000	14.6	5 300	3 000	6 300	* 6216 ZZ VV DDU	—	—	—	—	—	—	—	—	89	95.5	131	2	—	—	1.42
	140	26	2	72 500	53 000	14.6	4 500	3 000	5 300	6216 ZZ VV DDU	N NR	4.90	3.1	135.23	0.6	0.5	149.7	2.82	89	95.5	131	2	152	7.3	1.42
	170	39	2.1	129 000	86 500	13.3	4 500	2 800	5 600	* 6316 ZZ VV DDU	—	—	—	—	—	—	—	—	91	104.5	159	2	—	—	3.67
	170	39	2.1	123 000	86 500	13.3	4 000	2 800	4 800	6316 ZZ VV DDU	N NR	5.69	3.5	163.65	0.6	0.5	182.9	3.1	91	104.5	159	2	185	8.4	3.67
85	110	13	1	18 700	20 000	17.1	5 600	3 200	6 700	6817 ZZ VV DDU	N NR	2.10	1.3	107.6	0.4	0.5	115.7	1.12	90	90.5	105	1	117	2.9	0.263
	120	18	1.1	32 000	29 600	16.4	5 300	3 000	6 300	6917 ZZ VV DDU	N NR	3.30	1.3	117.6	0.4	0.5	125.7	1.12	91.5	94.5	113.5	1	127	4.1	0.55
	130	14	0.6	33 000	31 500	16.5	5 000	—	6 000	16017	—	—	—	—	—	—	—	—	89	—	126	0.6	—	—	0.652
	130	22	1.1	52 000	43 000	15.8	6 000	3 000	7 100	* 6017 ZZ VV DDU	—	—	—	—	—	—	—	—	91.5	96	123.5	1	—	—	0.918
	130	22	1.1	49 500	43 000	15.8	5 000	3 000	6 000	6017 ZZ VV DDU	N NR	2.87	3.1	125.22	0.6	0.5	139.7	2.82	91.5	96	123.5	1	141.5	5.3	0.918
	150	28	2	88 000	62 000	14.5	4 800	2 800	6 000	* 6217 ZZ VV DDU	—	—	—	—	—	—	—	—	94	102	141	2	—	—	1.76
	150	28	2	84 000	62 000	14.5	4 300	2 800	5 000	6217 ZZ VV DDU	N NR	4.90	3.1	145.24	0.6	0.5	159.7	2.82	94	102	141	2	162	7.3	1.76
	180	41	3	139 000	97 000	13.3	4 300	2 600	5 000	* 6317 ZZ VV DDU	—	—	—	—	—	—	—	—	98	110.5	167	2.5	—	—	4.28
	180	41	3	133 000	97 000	13.3	3 800	2 600	4 500	6317 ZZ VV DDU	N NR	5.69	3.5	173.66	0.6	0.5	192.9	3.1	98	110.5	167	2.5	195	8.4	4.28
90	115	13	1	19 000	21 000	17.2	5 300	3 000	6 300	6818 ZZ VV DDU	N NR	2.10	1.3	112.6	0.4	0.5	120.7	1.12	95	95.5	110	1	122	2.9	0.276
	125	18	1.1	33 000	31 500	16.5	5 000	2 800	6 000	6918 ZZ VV DDU	N NR	3.30	1.3	122.6	0.4	0.5	130.7	1.12	96.5	98.5	118.5	1	132	4.1	0.585
	140	16	1	41 500	39 500	16.3	4 800	—	5 600	16018	—	—	—	—	—	—	—	—	95	—	135	1	—	—	0.873
	140	24	1.5	61 000	50 000	15.6	5 600	2 800	6 300	* 6018 ZZ VV DDU	—	—	—	—	—	—	—	—	98	103	132	1.5	—	—	1.19
	140	24	1.5	58 000	50 000	15.6	4 800	2 800	5 600	6018 ZZ VV DDU	N NR	3.71	3.1	135.23	0.6	0.5	149.7	2.82	98	103	132	1.5	152	6.1	1.19
	160	30	2	101 000	71 500	14.5	4 500	2 600	5 600	* 6218 ZZ VV DDU	—	—	—	—	—	—	—	—	99	107.5	151	2	—	—	2.18
	160	30	2	96 000	71 500	14.5	4 000	2 600	4 800	6218 ZZ VV DDU	N NR	4.90	3.1	155.22	0.6	0.5	169.7	2.82	99	107.5	151	2	172	7.3	2.18
	190	43	3	150 000	107 000	13.3	4 000	2 400	4 800	* 6318 ZZ VV DDU	—	—	—	—	—	—	—	—	103	117	177	2.5	—	—	4.98
	190	43	3	143 000	107 000	13.3	3 600	2 400	4 300	6318 ZZ VV DDU	N NR	5.69	3.5	183.64	0.6	0.5	202.9	3.1	103	117	177	2.5	205	8.4	4.98

- Notes** (1) For tolerances of snap ring grooves and snap ring dimensions, refer to Pages A116 to A119.
 (2) When heavy axial loads are applied, d_a and D_a can be adjusted up to the shoulder diameter of the races. Please consult NSK for details.

- Remarks** 1. Diameter Series 7 (extra-thin wall) bearings are also available; please contact NSK for details.
 2. When using bearings with rotating outer rings, contact NSK if they are sealed, shielded, or have snap rings.
 3. Please consult NSK about the snap ring groove dimensions of Dimension Series 18 and 19 sealed and shielded bearings when the diameter is 50 mm or more.
 4. Bearings denoted by an asterisk (*) are NSKHPST™ deep groove ball bearings.

SINGLE-ROW DEEP GROOVE BALL BEARINGS

Bore Diameter 95 – 105 mm

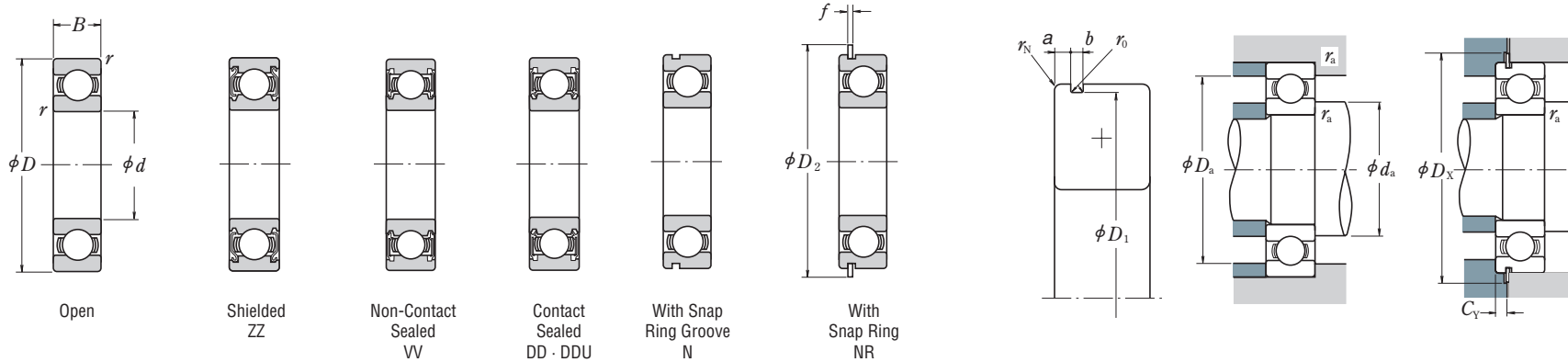

Dynamic Equivalent Load

$$P = XF_r + YF_a$$

$\frac{f_0 F_a}{C_{0r}}$	e	$\frac{F_a}{F_r} \leq e$		$\frac{F_a}{F_r} > e$	
		X	Y	X	Y
0.172	0.19	1	0	0.56	2.30
0.345	0.22	1	0	0.56	1.99
0.689	0.26	1	0	0.56	1.71
1.03	0.28	1	0	0.56	1.55
1.38	0.30	1	0	0.56	1.45
2.07	0.34	1	0	0.56	1.31
3.45	0.38	1	0	0.56	1.15
5.17	0.42	1	0	0.56	1.04
6.89	0.44	1	0	0.56	1.00

Static Equivalent Load

$$\frac{F_a}{F_r} > 0.8, P_0 = 0.6F_r + 0.5F_a$$

$$\frac{F_a}{F_r} \leq 0.8, P_0 = F_r$$

Boundary Dimensions (mm)	Basic Load Ratings (N)		Factor	Limiting Speeds (min ⁻¹)			Bearing Designations			With Snap Ring Groove	With Snap Ring	Snap Ring Groove Dimensions (1) (mm)					Snap Ring (1) Dimensions (mm)		Abutment and Fillet Dimensions (mm)					Mass (kg) approx.																						
												C_r	C_{0r}	f_0	Open Z	Grease ZZ VV	Oil DU DDU	Open Z	Open	Shielded	Sealed	a max.	b min.		D ₁ max.	r ₀ max.	r _N min.	D ₂ max.	f max.	D ₂ max.	f max.	d _a (2) min.	D _a (2) max.	r _a max.	D _x min.	C _Y max.										
																																					120	130	145	145	145	170	200	200	125	140
95	120	130	145	13	18	16	1	1.1	1	19 300	22 000	33 500	33 500	42 000	42 000	17.2	16.6	16.4	5 000	2 800	2 800	6 000	5 600	5 300	6819 ZZ VV DD	6919 ZZ VV DDU	16019	—	—	—	N	NR	2.10	1.3	117.6	0.4	0.5	125.7	1.12	100	101.5	115	1	127	2.9	0.297
	145	24	145	1.5	24	1.5	1.5	2.1	63 500	54 000	60 500	54 000	82 000	82 000	15.8	15.8	14.4	5 300	2 600	2 600	6 000	5 300	5 000	* 6019 ZZ VV DDU	* 6019 ZZ VV DDU	* 6219 ZZ VV DDU	—	—	—	—	N	NR	3.71	3.1	140.23	0.6	0.5	154.7	2.82	103	108.5	137	1.5	—	—	1.23
	170	32	200	2.1	45	3	3	3	109 000	82 000	160 000	119 000	119 000	14.4	13.3	13.3	3 800	2 600	2 400	4 500	4 300	3 600	* 6219 ZZ VV DDU	* 6319 ZZ VV DDU	* 6319 ZZ VV DDU	—	—	—	—	N	NR	5.69	3.5	163.65	0.6	0.5	182.9	3.1	106	114	159	2	185	8.4	2.64	
	200	45	200	3	45	3	3	3	160 000	119 000	153 000	119 000	—	—	—	13.3	3 000	2 400	2 400	4 300	3 600	3 600	* 6319 ZZ VV DDU	* 6319 ZZ VV DDU	—	—	—	—	N	NR	5.69	3.5	193.65	0.6	0.5	212.9	3.1	108	123.5	187	2.5	—	—	5.76		
	200	45	200	3	45	3	3	3	153 000	119 000	—	—	—	—	—	13.3	3 000	2 400	2 400	4 300	3 600	3 600	* 6319 ZZ VV DDU	* 6319 ZZ VV DDU	—	—	—	—	N	NR	5.69	3.5	193.65	0.6	0.5	212.9	3.1	108	123.5	187	2.5	215	8.4	5.76		
100	125	140	150	13	20	16	1	1.1	19 600	23 000	43 500	42 000	42 000	42 000	17.3	16.4	16.5	4 800	2 800	2 600	5 600	5 300	5 300	6820 ZZ VV DD	6920 ZZ VV DDU	16020	—	—	—	N	NR	2.10	1.3	122.6	0.4	0.5	130.7	1.12	105	105.5	120	1	132	2.9	0.31	
	150	24	150	1.5	24	1.5	1.5	2.1	63 000	54 000	60 000	54 000	93 000	93 000	15.9	15.9	14.4	5 000	2 600	2 600	6 000	5 300	4 800	* 6020 ZZ VV DDU	* 6020 ZZ VV DDU	* 6220 ZZ VV DDU	—	—	—	—	N	NR	3.71	3.1	145.24	0.6	0.5	159.7	2.82	108	112.5	142	1.5	—	—	1.29
	180	34	215	2.1	47	3	3	3	122 000	93 000	173 000	141 000	—	—	—	14.4	3 600	2 400	2 200	4 300	3 400	3 400	6220 ZZ VV DDU	6320 ZZ VV DDU	—	—	—	—	N	NR	5.69	3.5	173.66	0.6	0.5	192.9	3.1	111	121.5	169	2	195	8.4	3.17		
	215	47	215	3	47	3	3	3	173 000	141 000	—	—	—	—	—	13.2	2 800	2 200	2 200	4 300	3 400	3 400	6220 ZZ VV DDU	6320 ZZ VV DDU	—	—	—	—	N	NR	5.69	3.5	173.66	0.6	0.5	192.9	3.1	113	133	202	2.5	—	—	7.04		
105	130	145	160	13	20	18	1	1.1	19 800	23 900	42 500	42 000	50 500	50 500	17.4	16.5	16.3	4 800	2 600	—	5 600	5 300	4 800	6821 ZZ VV DDU	6921 ZZ VV —	16021	—	—	—	N	NR	2.10	1.3	127.6	0.4	0.5	135.7	1.12	110	110.5	125	1	137	2.9	0.324	
	160	26	160	2	26	2	2	2.1	76 000	66 000	72 500	66 000	105 000	105 000	15.8	15.8	14.4	4 500	2 400	2 400	5 600	4 800	4 500	* 6021 ZZ VV DDU	* 6021 ZZ VV DDU	* 6221 ZZ VV DDU	—	—	—	—	N	NR	3.71	3.1	155.22	0.6	0.5	169.7	2.82	114	120	151	2	—	—	1.58
	190	36	190	2.1	36	2.1	2.1	2.1	140 000	105 000	—	—	—	—	—	14.4	3 800	2 200	2 200	4 500	—	—	—	—	—	—	—	—	—	—	N	NR	—	—	—	—	—	—	—	—	—	—	—	3.79		
	225	49	225	3	49	3	3	3	133 000	105 000	184 000	154 000	—	—	—	14.4	3 400	2 200	2 000	4 000	3 200	3 200	6221 ZZ VV DDU	6321 ZZ — DDU	—	—	—	—	N	NR	5.69	3.5	183.64	0.6	0.5	202.9	3.1	116	127.5	179	2	205	8.4	3.79		
	225	49	225	3	49	3	3	3	184 000	154 000	—	—	—	—	—	13.2	2 600	2 000	2 000	4 000	3 200	3 200	6221 ZZ VV DDU	6321 ZZ — DDU	—	—	—	—	N	NR	—	—	—	—	—	—	—	—	—	—	—	—	—	8.09		

Notes (1) For tolerances of snap ring grooves and snap ring dimensions, refer to Pages A116 to A119.
 (2) When heavy axial loads are applied, d_a and D_a can be adjusted up to the shoulder diameter of the races. Please consult NSK for details.

Remarks 1. Diameter Series 7 (extra-thin wall) bearings are also available; please contact NSK for details.
 2. When using bearings with rotating outer rings, contact NSK if they are sealed, shielded, or have snap rings.
 3. Please consult NSK about the snap ring groove dimensions of Dimension Series 18 and 19 sealed and shielded bearings when the diameter is 50 mm or more.
 4. Bearings denoted by an asterisk (*) are NSKHPS™ deep groove ball bearings.

SINGLE-ROW DEEP GROOVE BALL BEARINGS

Bore Diameter 110 – 150 mm

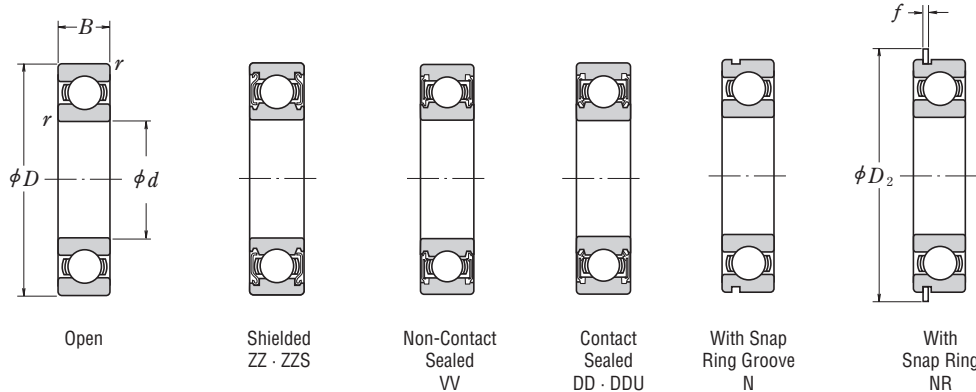

Dynamic Equivalent Load

$$P = XF_r + YF_a$$

$\frac{f_0 F_a}{C_{0r}}$	e	$\frac{F_a}{F_r} \leq e$		$\frac{F_a}{F_r} > e$	
		X	Y	X	Y
0.172	0.19	1	0	0.56	2.30
0.345	0.22	1	0	0.56	1.99
0.689	0.26	1	0	0.56	1.71
1.03	0.28	1	0	0.56	1.55
1.38	0.30	1	0	0.56	1.45
2.07	0.34	1	0	0.56	1.31
3.45	0.38	1	0	0.56	1.15
5.17	0.42	1	0	0.56	1.04
6.89	0.44	1	0	0.56	1.00

Static Equivalent Load

$$\frac{F_a}{F_r} > 0.8, P_0 = 0.6F_r + 0.5F_a$$

$$\frac{F_a}{F_r} \leq 0.8, P_0 = F_r$$

	Boundary Dimensions (mm)				Basic Load Ratings (N)		Factor f_0	Limiting Speeds (min ⁻¹)			Bearing Designations			With Snap Ring Groove	With Snap Ring Groove	Snap Ring Groove Dimensions (1) (mm)					Snap Ring (1) Dimensions (mm)		Abutment and Fillet Dimensions (mm)					Mass (kg) approx.
	d	D	B	r_{min}	C_r	C_{0r}		Grease		Oil	Open	Shielded	Sealed			a max.	b min.	D_1 max.	r_0 max.	r_N min.	D_2 max.	f max.	d_a (2) min.	D_a (2) max.	r_a max.	D_x min.	C_γ max.	
								Open Z·ZZ V·VV	DU DDU																			
110	140	16	1		28 100	32 500	17.1	4 300	2 400	5 300	6822 ZZ VV DDU	N	NR	2.50	1.9	137.6	0.6	0.5	145.7	1.7	115	117	135	1	147	3.9	0.497	
	150	20	1.1		43 500	44 500	16.6	4 300	2 400	5 000	6922 ZZ VV DDU	N	NR	3.30	1.9	147.6	0.6	0.5	155.7	1.7	116.5	121	143.5	1	157	4.7	0.893	
	170	19	1		57 500	56 500	16.3	3 800	—	4 500	16022 — — —	—	—	—	—	—	—	—	—	115	—	165	1	—	—	1.51		
	170	28	2		89 000	73 000	15.5	4 500	2 200	5 300	* 6022 ZZ VV DDU	—	—	—	—	—	—	—	—	119	124.5	161	2	—	—	1.94		
	170	28	2		85 000	73 000	15.5	3 800	2 200	4 500	6022 ZZ VV DDU	N	NR	3.71	3.5	163.65	0.6	0.5	182.9	3.1	119	124.5	161	2	185	6.4	1.94	
	200	38	2.1		144 000	117 000	14.3	2 800	2 200	3 400	6222 ZZ VV DDU	N	NR	5.69	3.5	193.65	0.6	0.5	212.9	3.1	121	134	189	2	215	8.4	4.45	
	240	50	3		205 000	179 000	13.2	2 400	—	3 000	6322 ZZ — —	—	—	—	—	—	—	—	—	123	147	227	2.5	—	—	9.51		
	150	16	1		28 900	35 500	17.3	4 000	2 200	4 800	6824 ZZ VV DD	N	NR	2.50	1.9	147.6	0.6	0.5	155.7	1.7	125	127	145	1	157	3.9	0.537	
	165	22	1.1		53 000	54 000	16.5	3 800	—	4 500	6924 ZZ — —	N	NR	3.70	1.9	161.8	0.6	0.5	171.5	1.7	126.5	132	158.5	1	173	5.1	1.21	
	180	19	1		56 500	57 500	16.5	3 600	—	4 300	16024 — — —	—	—	—	—	—	—	—	—	125	—	175	1	—	—	1.6		
180	28	2		92 500	80 000	15.7	4 000	2 200	4 800	* 6024 ZZ VV DDU	—	—	—	—	—	—	—	—	129	134.5	171	2	—	—	2.08			
180	28	2		88 000	80 000	15.7	3 600	2 200	4 300	6024 ZZ VV DDU	N	NR	3.71	3.5	173.66	0.6	0.5	192.9	3.1	129	134.5	171	2	195	6.4	2.08		
215	40	2.1		155 000	131 000	14.4	2 600	2 000	3 200	6224 ZZ VV DDU	—	—	—	—	—	—	—	—	131	146	204	2	—	—	5.29			
260	55	3		207 000	185 000	13.5	2 200	1 800	2 800	6324 ZS — —	—	—	—	—	—	—	—	—	133	161	247	2.5	—	—	12.5			
165	18	1.1		37 000	44 000	17.1	3 600	2 000	4 300	6826 ZS VV DD	N	NR	3.30	1.9	161.8	0.6	0.5	171.5	1.7	136.5	138	158.5	1	173	4.7	0.758		
180	24	1.5		65 000	67 500	16.5	3 400	—	4 000	6926 ZZ — —	N	NR	3.70	1.9	176.8	0.6	0.5	186.5	1.7	138	144	172	1.5	188	5.1	1.57		
200	22	1.1		75 500	77 500	16.4	3 000	—	3 600	16026 — — —	—	—	—	—	—	—	—	—	136.5	—	193.5	1	—	—	2.4			
200	33	2		106 000	101 000	15.8	3 000	1 900	3 600	6026 ZZ — —	N	NR	5.69	3.5	193.65	0.6	0.5	212.9	3.1	139	148.5	191	2	215	8.4	3.26		
230	40	3		167 000	146 000	14.5	2 400	—	3 000	6226 ZZ — —	—	—	—	—	—	—	—	—	143	157	217	2.5	—	—	5.96			
280	58	4		229 000	214 000	13.6	2 200	—	2 600	6326 ZS — —	—	—	—	—	—	—	—	—	146	175	264	3	—	—	15.2			
175	18	1.1		38 500	48 000	17.3	3 400	1 900	4 000	6828 ZZ VV DDU	N	NR	3.30	1.9	171.8	0.6	0.5	181.5	1.7	146.5	148.5	168.5	1	183	4.7	0.832		
190	24	1.5		66 500	72 000	16.6	3 200	—	3 800	6928 ZS VV —	N	NR	3.70	1.9	186.8	0.6	0.5	196.5	1.7	148	153.5	182	1.5	198	5.1	1.67		
210	22	1.1		77 500	82 500	16.5	2 800	—	3 400	16028 — — —	—	—	—	—	—	—	—	—	146.5	—	203.5	1	—	—	2.84			
210	33	2		110 000	109 000	16.0	2 800	1 800	3 400	6028 ZZ — —	—	—	—	—	—	—	—	—	149	158.5	201	2	—	—	3.48			
250	42	3		166 000	150 000	14.9	2 200	1 700	2 800	6228 ZS — —	—	—	—	—	—	—	—	—	153	171.5	237	2.5	—	—	7.68			
300	62	4		253 000	246 000	13.6	2 000	—	2 400	6328 ZS — —	—	—	—	—	—	—	—	—	156	187	284	3	—	—	18.5			
190	20	1.1		47 500	58 500	17.1	3 200	1 800	3 800	6830 ZZ VV DDU	N	NR	3.30	1.9	186.8	0.6	0.5	196.5	1.7	156.5	160	183.5	1	198	4.7	1.15		
210	28	2		85 000	90 500	16.5	2 600	1 700	3 200	6930 ZZ — —	—	—	—	—	—	—	—	—	159	166	201	2	—	—	3.01			
225	24	1.1		84 000	91 000	16.6	2 600	—	3 000	16030 — — —	—	—	—	—	—	—	—	—	156.5	—	218.5	1	—	—	3.62			
225	35	2.1		126 000	126 000	15.9	2 600	1 700	3 000	6030 ZZ VV DDU	—	—	—	—	—	—	—	—	161	170	214	2	—	—	4.24			
270	45	3		176 000	168 000	15.1	2 000	—	2 600	6230 ZS — —	—	—	—	—	—	—	—	—	163	186	257	2.5	—	—	10			
320	65	4		274 000	284 000	13.9	1 800	—	2 200	6330 ZS — —	—	—	—	—	—	—	—	—	166	203	304	3	—	—	22.7			

Notes (1) For tolerances of snap ring grooves and snap ring dimensions, refer to Pages A116 to A119.
 (2) When heavy axial loads are applied, d_a and D_a can be adjusted up to the shoulder diameter of the races. Please consult NSK for details.

Remarks 1. When using bearings with rotating outer rings, contact NSK if they are sealed, shielded, or have snap rings.
 2. Please consult NSK about the snap ring groove dimensions of Dimension Series 18 and 19 sealed and shielded bearings when the diameter is 50 mm or more.
 3. Bearings denoted by an asterisk (*) are NSKHPS™ deep groove ball bearings.

■ SINGLE-ROW DEEP GROOVE BALL BEARINGS

Bore Diameter 160 mm

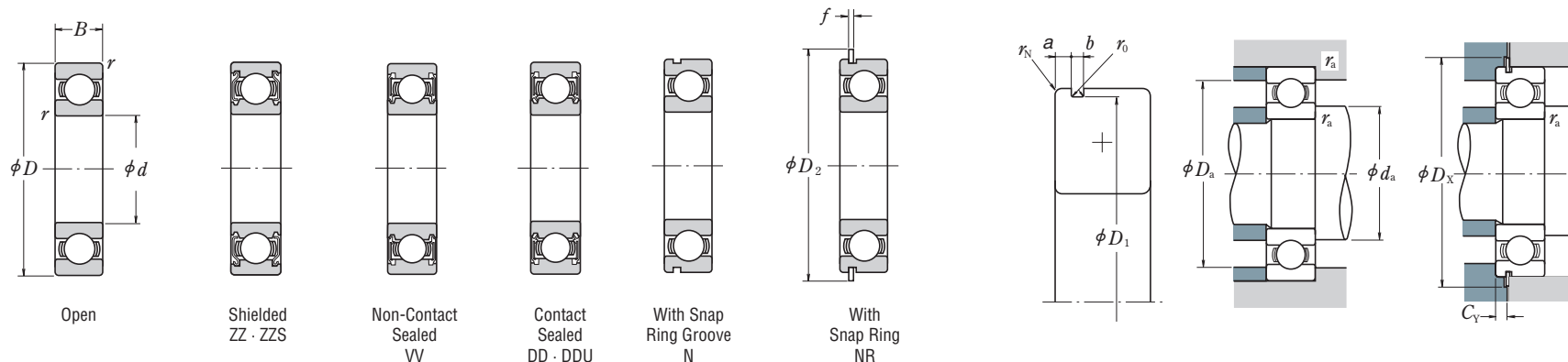

Dynamic Equivalent Load

$$P = XF_r + YF_a$$

$\frac{f_0 F_a}{C_{0r}}$	e	$\frac{F_a}{F_r} \leq e$		$\frac{F_a}{F_r} > e$	
		X	Y	X	Y
0.172	0.19	1	0	0.56	2.30
0.345	0.22	1	0	0.56	1.99
0.689	0.26	1	0	0.56	1.71
1.03	0.28	1	0	0.56	1.55
1.38	0.30	1	0	0.56	1.45
2.07	0.34	1	0	0.56	1.31
3.45	0.38	1	0	0.56	1.15
5.17	0.42	1	0	0.56	1.04
6.89	0.44	1	0	0.56	1.00

Static Equivalent Load

$$\frac{F_a}{F_r} > 0.8, P_0 = 0.6F_r + 0.5F_a$$

$$\frac{F_a}{F_r} \leq 0.8, P_0 = F_r$$

Boundary Dimensions (mm)				Basic Load Ratings (N)		Factor	Limiting Speeds (min ⁻¹)			Bearing Designations			Snap Ring Groove Dimensions (1) (mm)		Snap Ring (1) Dimensions (mm)		Abutment and Fillet Dimensions (mm)					Mass (kg)								
d	D	B	r min.	C_r	C_{0r}	f_0	Grease		Oil	Open	Shielded	Sealed	With Snap Ring Groove	With Snap Ring Groove	a max.	b min.	D_1 max.	r_0 max.	r_N min.	D_2 max.	f max.	min.	d_a (2)	D_a (2)	r_a max.	D_x min.	C_y max.	approx.		
160	200	20	1.1	48 500	61 000	17.2	2 600	1 700	3 200	6832	ZZS	VV	DDU	N	NR	3.30	1.9	196.8	0.6	0.5	206.5	1.7	166.5	170.5	193.5	1	208	4.7	1.23	
	220	28	2	87 000	96 000	16.6	2 600	1 600	3 000	6932	ZZS	—	DDU	—	—	—	—	—	—	—	—	—	169	176	211	2	—	—	2.71	
	240	25	1.5	99 000	108 000	16.5	2 400	—	2 800	16032	—	—	—	—	—	—	—	—	—	—	—	—	168	—	232	1.5	—	—	4.2	
	240	38	2.1	137 000	135 000	15.9	2 400	1 600	2 800	6032	ZZ	—	DDU	—	—	—	—	—	—	—	—	—	—	171	181.5	229	2	—	—	5.15
	290	48	3	185 000	186 000	15.4	1 900	—	2 400	6232	ZZS	—	—	—	—	—	—	—	—	—	—	—	—	173	202	277	2.5	—	—	12.8
	340	68	4	278 000	287 000	13.9	1 700	—	2 000	6332	ZZS	—	—	—	—	—	—	—	—	—	—	—	—	176	215.5	324	3	—	—	26.2

- Notes** (1) For tolerances of snap ring grooves and snap ring dimensions, refer to Pages A116 to A119.
 (2) When heavy axial loads are applied, d_a and D_a can be adjusted up to the shoulder diameter of the races. Please consult NSK for details.

- Remarks** 1. When using bearings with rotating outer rings, contact NSK if they are sealed, shielded, or have snap rings.
 2. Please consult NSK about the snap ring groove dimensions of Dimension Series 18 and 19 sealed and shielded bearings when the diameter is 50 mm or more.

■ SINGLE-ROW DEEP GROOVE BALL BEARINGS

Bore Diameter 170 – 240 mm

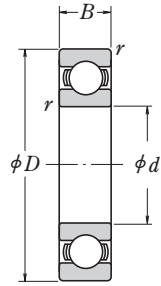

Open



Shielded
ZZS



Non-Contact
Sealed
VV

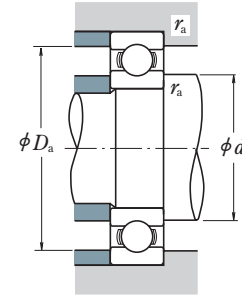

Dynamic Equivalent Load

$$P = XF_r + YF_a$$

$\frac{f_0 F_a}{C_{0r}}$	e	$\frac{F_a}{F_r} \leq e$		$\frac{F_a}{F_r} > e$	
		X	Y	X	Y
0.172	0.19	1	0	0.56	2.30
0.345	0.22	1	0	0.56	1.99
0.689	0.26	1	0	0.56	1.71
1.03	0.28	1	0	0.56	1.55
1.38	0.30	1	0	0.56	1.45
2.07	0.34	1	0	0.56	1.31
3.45	0.38	1	0	0.56	1.15
5.17	0.42	1	0	0.56	1.04
6.89	0.44	1	0	0.56	1.00

Static Equivalent Load

$$\frac{F_a}{F_r} > 0.8, P_0 = 0.6F_r + 0.5F_a$$

$$\frac{F_a}{F_r} \leq 0.8, P_0 = F_r$$

Boundary Dimensions (mm)				Basic Load Ratings (N)		Factor f_0	Limiting Speeds (min ⁻¹)			Bearing Designations			Abutment and Fillet Dimensions (mm)				Mass (kg)	
d	D	B	r min.	C_r	C_{0r}		Grease		Oil	Open	Shielded	Sealed	$d_a^{(1)}$ min.	$d_a^{(1)}$ max.	$D_a^{(1)}$ max.	r_a max.		approx.
170	215	22	1.1	60 000	75 000	17.1	2 600	1 600	3 000	6834	ZZS	VV	DDU	176.5	182	208.5	1	1.86
	230	28	2	86 000	97 000	16.7	2 400	—	2 800	6934	ZZS	—	—	179	186	221	2	3.34
	260	28	1.5	114 000	126 000	16.5	2 200	—	2 600	16034	—	—	—	178	—	252	1.5	5.71
	260	42	2.1	161 000	161 000	15.8	2 200	—	2 600	6034	ZZS	VV	—	181	194.5	249	2	6.89
	310	52	4	212 000	224 000	15.3	1 800	—	2 200	6234	ZZS	—	—	186	215	294	3	15.8
180	360	72	4	325 000	355 000	13.6	1 600	—	2 000	6334	—	—	—	186	—	344	3	36.6
	225	22	1.1	60 500	78 500	17.2	2 400	—	2 800	6836	—	VV	—	186.5	192	218.5	1	1.98
	250	33	2	119 000	128 000	16.4	2 200	—	2 600	6936	ZZS	—	—	189	198.5	241	2	4.16
	280	31	2	145 000	157 000	16.3	2 000	—	2 400	16036	—	—	—	189	—	271	2	7.5
	280	46	2.1	180 000	185 000	15.6	2 000	—	2 400	6036	ZZS	VV	—	191	208	269	2	8.88
190	320	52	4	227 000	241 000	15.1	1 700	—	2 000	6236	ZZS	—	—	196	223	304	3	15.9
	380	75	4	355 000	405 000	13.9	1 500	—	1 800	6336	—	—	—	196	—	364	3	43.1
	240	24	1.5	73 000	93 500	17.1	2 200	—	2 600	6838	—	VV	—	198	202.5	232	1.5	2.53
	260	33	2	113 000	127 000	16.6	2 200	—	2 600	6938	—	—	—	199	—	251	2	5.18
	290	31	2	149 000	168 000	16.4	2 000	—	2 400	16038	—	—	—	199	—	281	2	7.78
200	290	46	2.1	188 000	201 000	15.8	2 000	—	2 400	6038	ZZS	—	—	201	218	279	2	9.39
	340	55	4	255 000	282 000	15.0	1 600	—	2 000	6238	ZZS	—	—	206	236	324	3	22.3
	400	78	5	355 000	415 000	14.1	1 400	—	1 700	6338	—	—	—	210	—	380	4	49.7
	250	24	1.5	74 000	98 000	17.2	2 200	—	2 600	6840	—	—	—	208	—	242	1.5	2.67
	280	38	2.1	143 000	158 000	16.4	2 000	—	2 400	6940	ZZS	—	—	211	222	269	2	7.28
220	310	34	2	161 000	180 000	16.4	1 900	—	2 200	16040	—	—	—	209	—	301	2	10
	310	51	2.1	207 000	226 000	15.6	1 900	—	2 200	6040	ZZS	—	—	211	231.5	299	2	12
	360	58	4	269 000	310 000	15.2	1 500	—	1 800	6240	ZZS	—	—	216	252	344	3	26.7
	420	80	5	380 000	445 000	13.8	1 300	—	1 600	6340	—	—	—	220	—	400	4	55.3
	270	24	1.5	76 500	107 000	17.4	1 900	—	2 400	6844	ZZS	—	—	228	233.5	262	1.5	2.9
240	300	38	2.1	146 000	169 000	16.6	1 800	—	2 200	6944	ZZS	—	—	231	242	289	2	7.88
	340	37	2.1	180 000	217 000	16.5	1 600	—	2 000	16044	—	—	—	231	—	329	2	13.1
	340	56	3	235 000	271 000	15.6	1 700	—	2 000	6044	ZZS	—	—	233	254.5	327	2.5	18.6
	400	65	4	310 000	375 000	15.1	1 300	—	1 600	6244	—	—	—	236	—	384	3	37.4
	460	88	5	410 000	520 000	14.3	1 200	—	1 500	6344	—	—	—	240	—	440	4	73.9
240	300	28	2	98 500	137 000	17.3	1 700	—	2 000	6848	—	—	—	249	—	291	2	4.48
	320	38	2.1	154 000	190 000	16.8	1 700	—	2 000	6948	ZZS	—	—	251	262	309	2	8.49
	360	37	2.1	196 000	243 000	16.5	1 500	—	1 900	16048	—	—	—	251	—	349	2	13.9
	360	56	3	244 000	296 000	15.9	1 500	—	1 900	6048	—	—	—	253	—	347	2.5	19.9
	440	72	4	340 000	430 000	15.2	1 200	—	1 500	6248	—	—	—	256	—	424	3	50.5
500	95	5	470 000	625 000	14.2	1 100	—	1 300	6348	—	—	—	260	—	480	4	94.4	

Note (1) When heavy axial loads are applied, d_a and D_a can be adjusted up to the shoulder diameter of the races. Please consult NSK for details.

Remark When using bearings with rotating outer rings, contact NSK if they are sealed or shielded.

■ SINGLE-ROW DEEP GROOVE BALL BEARINGS

Bore Diameter 260 – 360 mm

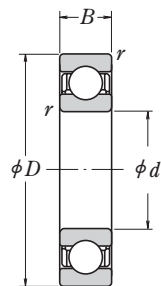

Open

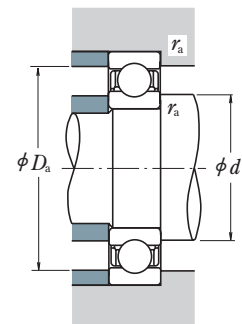

Dynamic Equivalent Load

$$P = XF_r + YF_a$$

$\frac{f_0 F_a}{C_{0r}}$	e	$\frac{F_a}{F_r} \leq e$		$\frac{F_a}{F_r} > e$	
		X	Y	X	Y
0.172	0.19	1	0	0.56	2.30
0.345	0.22	1	0	0.56	1.99
0.689	0.26	1	0	0.56	1.71
1.03	0.28	1	0	0.56	1.55
1.38	0.30	1	0	0.56	1.45
2.07	0.34	1	0	0.56	1.31
3.45	0.38	1	0	0.56	1.15
5.17	0.42	1	0	0.56	1.04
6.89	0.44	1	0	0.56	1.00

Static Equivalent Load

$$\frac{F_a}{F_r} > 0.8, P_0 = 0.6F_r + 0.5F_a$$

$$\frac{F_a}{F_r} \leq 0.8, P_0 = F_r$$

Boundary Dimensions (mm)				Basic Load Ratings (N)		Factor f_0	Limiting Speeds (min ⁻¹)		Bearing Designations Open	Abutment and Fillet Dimensions (mm)			Mass (kg) approx.
d	D	B	r min.	C_r	C_{0r}		Grease	Oil		$d_a^{(1)}$ min.	$D_a^{(1)}$ max.	r_a max.	
260	320	28	2	101 000	148 000	17.4	1 600	1 900	6852	269	311	2	4.84
	360	46	2.1	204 000	255 000	16.5	1 500	1 800	6952	271	349	2	14
	400	44	3	237 000	310 000	16.4	1 400	1 700	16052	273	387	2.5	21.1
	400	65	4	291 000	375 000	15.8	1 400	1 700	6052	276	384	3	29.4
	480	80	5	400 000	540 000	15.1	1 100	1 300	6252	280	460	4	67
	540	102	6	505 000	710 000	14.6	1 000	1 200	6352	286	514	5	118
280	350	33	2	133 000	191 000	17.3	1 500	1 700	6856	289	341	2	7.2
	380	46	2.1	209 000	272 000	16.6	1 400	1 700	6956	291	369	2	15.1
	420	44	3	243 000	330 000	16.5	1 300	1 600	16056	293	407	2.5	22.7
	420	65	4	300 000	410 000	16.0	1 300	1 600	6056	296	404	3	31.2
	500	80	5	400 000	550 000	15.2	1 000	1 300	6256	300	480	4	70.4
	580	108	6	570 000	840 000	14.5	900	1 100	6356	306	554	5	144
300	380	38	2.1	166 000	233 000	17.1	1 300	1 600	6860	311	369	2	10.3
	420	56	3	269 000	370 000	16.4	1 300	1 500	6960	313	407	2.5	23.9
	460	50	4	285 000	405 000	16.4	1 200	1 400	16060	316	444	3	31.5
	460	74	4	355 000	500 000	15.8	1 200	1 400	6060	316	444	3	44.2
	540	85	5	465 000	670 000	15.1	950	1 200	6260	320	520	4	87.8
	320	400	38	2.1	168 000	244 000	17.2	1 300	1 500	6864	331	389	2
440		56	3	266 000	375 000	16.5	1 200	1 400	6964	333	427	2.5	25.3
480		50	4	293 000	430 000	16.5	1 100	1 300	16064	336	464	3	33.2
	480	74	4	390 000	570 000	15.7	1 100	1 300	6064	336	464	3	46.5
	580	92	5	530 000	805 000	15.0	850	1 100	6264	340	560	4	111
	340	420	38	2.1	175 000	265 000	17.3	1 200	1 400	6868	351	409	2
460		56	3	273 000	400 000	16.6	1 100	1 300	6968	353	447	2.5	26.6
520		82	5	440 000	660 000	15.6	1 000	1 200	6068	360	500	4	62.3
620	92	6	530 000	820 000	15.3	800	1 000	6268	366	594	5	129	
360	440	38	2.1	192 000	290 000	17.3	1 100	1 300	6872	371	429	2	11.8
	480	56	3	280 000	425 000	16.7	1 100	1 300	6972	373	467	2.5	27.9
	540	82	5	460 000	720 000	15.7	950	1 200	6072	380	520	4	65.3
650	95	6	555 000	905 000	15.4	750	950	6272	386	624	5	145	

Note (1) When heavy axial loads are applied, d_a and D_a can be adjusted up to the shoulder diameter of the races. Please consult NSK for details.

■ SINGLE-ROW DEEP GROOVE BALL BEARINGS

Bore Diameter 380 – 600 mm

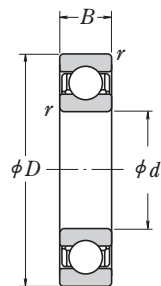

Open

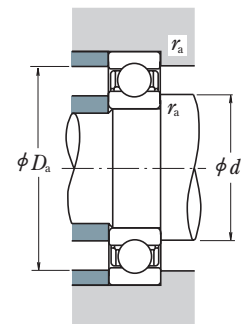

Dynamic Equivalent Load

$$P = XF_r + YF_a$$

$\frac{f_0 F_a}{C_{0r}}$	e	$\frac{F_a}{F_r} \leq e$		$\frac{F_a}{F_r} > e$	
		X	Y	X	Y
0.172	0.19	1	0	0.56	2.30
0.345	0.22	1	0	0.56	1.99
0.689	0.26	1	0	0.56	1.71
1.03	0.28	1	0	0.56	1.55
1.38	0.30	1	0	0.56	1.45
2.07	0.34	1	0	0.56	1.31
3.45	0.38	1	0	0.56	1.15
5.17	0.42	1	0	0.56	1.04
6.89	0.44	1	0	0.56	1.00

Static Equivalent Load

$$\frac{F_a}{F_r} > 0.8, P_0 = 0.6F_r + 0.5F_a$$

$$\frac{F_a}{F_r} \leq 0.8, P_0 = F_r$$

Boundary Dimensions (mm)				Basic Load Ratings (N)		Factor	Limiting Speeds (min ⁻¹)		Bearing Designations	Abutment and Fillet Dimensions (mm)			Mass (kg) approx.	
d	D	B	r min.	C_r	C_{0r}	f_0	Grease	Oil		Open	$d_{a(1)}$ min.	$D_{a(1)}$ max.		r_a max.
380	480	46	2.1	238 000	375 000	17.1	1 000	1 200	6876	391	469	2	19.5	
	520	65	4	325 000	510 000	16.6	950	1 200		6976	396	504	3	40
	560	82	5	455 000	725 000	15.9	900	1 100		6076	400	540	4	68
400	500	46	2.1	241 000	390 000	17.2	950	1 200	6880	411	489	2	20.5	
	540	65	4	335 000	540 000	16.7	900	1 100		6980	416	524	3	42
	600	90	5	510 000	825 000	15.7	850	1 000		6080	420	580	4	88.4
420	520	46	2.1	245 000	410 000	17.3	900	1 100	6884	431	509	2	21.4	
	560	65	4	340 000	570 000	16.8	900	1 100		6984	436	544	3	43.6
	620	90	5	530 000	895 000	15.8	800	1 000		6084	440	600	4	92.2
440	540	46	2.1	248 000	425 000	17.4	900	1 100	6888	451	529	2	22.3	
	600	74	4	395 000	680 000	16.6	800	1 000		6988	456	584	3	60.2
	650	94	6	550 000	965 000	16.0	750	900		6088	466	624	5	106
460	580	56	3	310 000	550 000	17.1	800	1 000	6892	473	567	2.5	34.3	
	620	74	4	405 000	720 000	16.7	800	950		6992	476	604	3	62.6
	680	100	6	605 000	1 080 000	15.8	710	850		6092	486	654	5	123
480	600	56	3	315 000	575 000	17.2	800	950	6896	493	587	2.5	35.4	
	650	78	5	450 000	815 000	16.6	750	900		6996	500	630	4	73.5
	700	100	6	605 000	1 090 000	15.9	710	850		6096	506	674	5	127
500	620	56	3	320 000	600 000	17.3	750	900	68/500	513	607	2.5	37.2	
	670	78	5	460 000	865 000	16.7	710	850		69/500	520	650	4	82
	720	100	6	630 000	1 170 000	16.0	670	800		60/500	526	694	5	131
530	650	56	3	325 000	625 000	17.4	710	850	68/530	543	637	2.5	39.8	
	710	82	5	455 000	870 000	16.8	670	800		69/530	550	690	4	89.8
	780	112	6	680 000	1 300 000	16.0	600	750		60/530	556	754	5	184
560	680	56	3	330 000	650 000	17.4	670	800	68/560	573	667	2.5	41.5	
	750	85	5	525 000	1 040 000	16.7	600	750		69/560	580	730	4	105
	820	115	6	735 000	1 500 000	16.2	560	670		60/560	586	793.5	5	203
600	730	60	3	355 000	735 000	17.5	600	710	68/600	613	717	2.5	50.9	
	800	90	5	550 000	1 160 000	16.9	560	670		69/600	620	780	4	120
	870	118	6	790 000	1 640 000	16.1	530	630		60/600	626	844	5	236

Note (1) When heavy axial loads are applied, d_a and D_a can be adjusted up to the shoulder diameter of the races. Please consult NSK for details.

■ SINGLE-ROW DEEP GROOVE BALL BEARINGS

Bore Diameter 630 – 800 mm

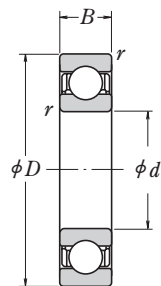

Open

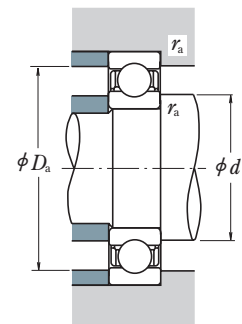

Dynamic Equivalent Load

$$P = XF_r + YF_a$$

$\frac{f_0 F_a}{C_{0r}}$	e	$\frac{F_a}{F_r} \leq e$		$\frac{F_a}{F_r} > e$	
		X	Y	X	Y
0.172	0.19	1	0	0.56	2.30
0.345	0.22	1	0	0.56	1.99
0.689	0.26	1	0	0.56	1.71
1.03	0.28	1	0	0.56	1.55
1.38	0.30	1	0	0.56	1.45
2.07	0.34	1	0	0.56	1.31
3.45	0.38	1	0	0.56	1.15
5.17	0.42	1	0	0.56	1.04
6.89	0.44	1	0	0.56	1.00

Static Equivalent Load

$$\frac{F_a}{F_r} > 0.8, P_0 = 0.6F_r + 0.5F_a$$

$$\frac{F_a}{F_r} \leq 0.8, P_0 = F_r$$

Boundary Dimensions (mm)				Basic Load Ratings (N)		Factor f_0	Limiting Speeds (min ⁻¹)		Bearing Designations Open	Abutment and Fillet Dimensions (mm)			Mass (kg) approx.
d	D	B	r min.	C_r	C_{0r}		Grease	Oil		$d_a^{(1)}$ min.	$D_a^{(1)}$ max.	r_a max.	
630	780	69	4	420 000	890 000	17.3	560	670	68/630 69/630 60/630	646	764	3	71.3
	850	100	6	625 000	1 350 000	16.7	530	630		656	824	5	163
	920	128	7.5	750 000	1 620 000	16.4	480	600		662	888	6	285
670	820	69	4	435 000	965 000	17.4	500	630	68/670 69/670 60/670	686	804	3	75.4
	900	103	6	675 000	1 460 000	16.7	480	560		696	874	5	181
	980	136	7.5	765 000	1 730 000	16.6	450	530		702	948	6	351
710	870	74	4	480 000	1 100 000	17.4	480	560	68/710 69/710	726	854	3	92.6
	950	106	6	715 000	1 640 000	16.8	450	530		736	924	5	208
750	920	78	5	525 000	1 260 000	17.4	430	530	68/750 69/750	770	900	4	110
	1 000	112	6	785 000	1 840 000	16.7	400	500		776	974	5	245
800	980	82	5	530 000	1 310 000	17.5	400	480	68/800 69/800	820	960	4	132
	1 060	115	6	825 000	2 050 000	16.8	380	450		826	1 034	5	275

Note (1) When heavy axial loads are applied, d_a and D_a can be adjusted up to the shoulder diameter of the races. Please consult NSK for details.

Bore Diameter 10 – 100 mm

Boundary Dimensions (mm)			Basic Load Ratings (N)		Recommended Fits (1)	Bearing Designations			
<i>d</i>	<i>D</i>	<i>B</i>	<i>C_r</i>	<i>C_{0r}</i>		Basic Designation (Open)	Shields	Contact Seal (2)	Non-Contact Seal
10	26	8	4 550	1 970	H7 or G6	6000	ZZ	DDU	VV
	30	9	5 100	2 390		6200	ZZ	DDU	VV
	35	11	8 100	3 450		6300	ZZ	DDU	VV
12	28	8	5 100	2 370		6001	ZZ	DDU	VV
	32	10	6 800	3 050		6201	ZZ	DDU	VV
	37	12	9 700	4 200		6301	ZZ	DDU	VV
15	32	9	5 600	2 830		6002	ZZ	DDU	VV
	35	11	7 650	3 750		6202	ZZ	DDU	VV
	42	13	11 400	5 450		6302	ZZ	DDU	VV
17	35	10	6 000	3 250		6003	ZZ	DDU	VV
	40	12	9 550	4 800		6203	ZZ	DDU	VV
	47	14	13 600	6 650		6303	ZZ	DDU	VV
20	42	12	9 400	5 000		6004	ZZ	DDU	VV
	47	14	12 800	6 600		6204	ZZ	DDU	VV
	52	15	15 900	7 900		6304	ZZ	DDU	VV
25	47	12	10 100	5 850		6005	ZZ	DDU	VV
	52	15	14 000	7 850		6205	ZZ	DDU	VV
	62	17	20 600	11 200		6305	ZZ	DDU	VV
30	55	13	13 200	8 300		6006	ZZ	DDU	VV
	62	16	19 500	11 300		6206	ZZ	DDU	VV
	72	19	26 700	15 000	6306	ZZ	DDU	VV	
35	62	14	16 000	10 300	6007	ZZ	DDU	VV	
	72	17	25 700	15 300	6207	ZZ	DDU	VV	
	80	21	33 500	19 200	6307	ZZ	DDU	VV	
40	68	15	16 800	11 500	6008	ZZ	DDU	VV	
	80	18	29 100	17 900	6208	ZZ	DDU	VV	
	90	23	40 500	24 000	6308	ZZ	DDU	VV	
45	75	16	20 900	15 200	6009	ZZ	DDU	VV	
	85	19	31 500	20 400	6209	ZZ	DDU	VV	
	100	25	53 000	32 000	6309	ZZ	DDU	VV	
50	80	16	21 800	16 600	6010	ZZ	DDU	VV	
	90	20	35 000	23 200	6210	ZZ	DDU	VV	
	110	27	62 000	38 500	6310	ZZ	DDU	VV	
55	90	18	28 300	21 200	6011	ZZ	DDU	VV	
	100	21	43 500	29 300	6211	ZZ	DDU	VV	
	120	29	71 500	44 500	6311	ZZ	DDU	VV	
60	95	18	29 500	23 200	6012	ZZ	DDU	VV	
	110	22	52 500	36 000	6212	ZZ	DDU	VV	
	130	31	82 000	52 000	6312	ZZ	DDU	VV	
65	100	18	30 500	25 200	6013	ZZ	DDU	VV	
	120	23	57 500	40 000	6213	ZZ	DDU	VV	
	140	33	92 500	60 000	6313	ZZ	DDU	VV	
70	110	20	38 000	31 000	6014	ZZ	DDU	VV	
	125	24	62 000	44 000	6214	ZZ	DDU	VV	
	150	35	104 000	68 000	6314	ZZ	DDU	VV	
75	115	20	39 500	33 500	6015	ZZ	DDU	VV	
	130	25	66 000	49 500	6215	ZZ	DDU	VV	
80	125	22	47 500	40 000	6016	ZZ	DDU	VV	
	140	26	72 500	53 000	6216	ZZ	DDU	VV	
85	130	22	49 500	43 000	6017	ZZ	DDU	VV	
	150	28	84 000	62 000	6217	ZZ	DDU	VV	
90	140	24	58 000	50 000	6018	ZZ	DDU	VV	
95	145	24	60 500	54 000	6019	ZZ	DDU	VV	
100	150	24	60 000	54 000	6020	ZZ	DDU	VV	

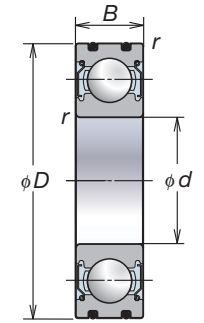

Notes (1) Although recommended fits are H7 or G6, G6 is recommended when used under conditions that prioritize insertion under light preload.

(2) Low-contact seals are available for sealed bearings; contact NSK for details.

MAXIMUM BALL BEARINGS

Bore Diameter 25 – 110 mm

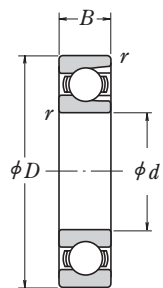

Open



Shielded
(One Shield) Z



Shielded
(Two Shields) ZZ

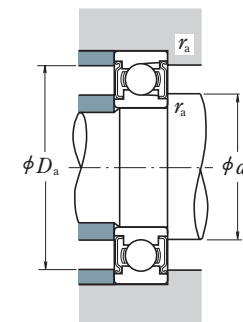
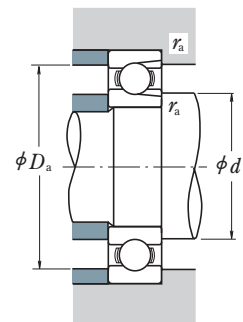

Boundary Dimensions (mm)				Basic Load Ratings (N)		Limiting Speeds (min ⁻¹)		Bearing Designations			Abutment and Fillet Dimensions (mm)				Mass (kg)
<i>d</i>	<i>D</i>	<i>B</i>	<i>r</i> min.	<i>C_r</i>	<i>C_{0r}</i>	Grease Open Z · ZZ	Oil Open Z	Open	With One Shield	With Two Shields	<i>d_a</i> min.	<i>d_b</i> max.	<i>D_a</i> max.	<i>r_a</i> max.	approx.
25	52	15	1	14 400	10 500	12 000	15 000	BL 205	BL 205 Z	BL 205 ZZ	30	32	47	1	0.133
	62	17	1.1	21 500	15 500	11 000	13 000	BL 305	BL 305 Z	BL 305 ZZ	31.5	36	55.5	1	0.246
30	62	16	1	21 000	16 300	10 000	12 000	BL 206	BL 206 Z	BL 206 ZZ	35	38.5	57	1	0.215
	72	19	1.1	27 900	20 700	9 000	11 000	BL 306	BL 306 Z	BL 306 ZZ	36.5	42	65.5	1	0.364
35	72	17	1.1	27 800	22 100	9 000	11 000	BL 207	BL 207 Z	BL 207 ZZ	41.5	44.5	65.5	1	0.307
	80	21	1.5	37 000	29 100	8 000	9 500	BL 307	BL 307 Z	BL 307 ZZ	43	44.5	72	1.5	0.486
40	80	18	1.1	35 500	28 800	8 000	9 500	BL 208	BL 208 Z	BL 208 ZZ	46.5	50	73.5	1	0.394
	90	23	1.5	46 500	36 000	7 500	9 000	BL 308	BL 308 Z	BL 308 ZZ	48	52.5	82	1.5	0.685
45	85	19	1.1	37 000	32 000	7 500	9 000	BL 209	BL 209 Z	BL 209 ZZ	51.5	55.5	78.5	1	0.449
	100	25	1.5	55 500	44 000	6 300	8 000	BL 309	BL 309 Z	BL 309 ZZ	53	61.5	92	1.5	0.883
50	90	20	1.1	39 000	35 000	6 700	8 500	BL 210	BL 210 Z	BL 210 ZZ	56.5	60	83.5	1	0.504
	110	27	2	65 000	52 500	6 000	7 100	BL 310	BL 310 Z	BL 310 ZZ	59	68	101	2	1.16
55	100	21	1.5	48 000	44 000	6 300	7 500	BL 211	BL 211 Z	BL 211 ZZ	63	66.5	92	1.5	0.667
	120	29	2	75 000	61 500	5 600	6 700	BL 311	BL 311 Z	BL 311 ZZ	64	72.5	111	2	1.49
60	110	22	1.5	58 000	54 000	5 600	6 700	BL 212	BL 212 Z	BL 212 ZZ	68	74.5	102	1.5	0.856
	130	31	2.1	85 500	71 500	5 000	6 000	BL 312	BL 312 Z	BL 312 ZZ	71	79	119	2	1.88
65	120	23	1.5	63 500	60 000	5 300	6 300	BL 213	BL 213 Z	BL 213 ZZ	73	80	112	1.5	1.09
	140	33	2.1	103 000	89 500	4 800	5 600	BL 313	BL 313 Z	BL 313 ZZ	76	85.5	129	2	2.36
70	125	24	1.5	69 000	66 000	5 000	6 000	BL 214	BL 214 Z	BL 214 ZZ	78	84	117	1.5	1.19
	150	35	2.1	115 000	102 000	4 300	5 300	BL 314	BL 314 Z	BL 314 ZZ	81	92	139	2	2.87
75	130	25	1.5	72 000	72 000	4 500	5 600	BL 215	BL 215 Z	BL 215 ZZ	83	90	122	1.5	1.29
	160	37	2.1	126 000	116 000	4 000	5 000	BL 315	BL 315 Z	BL 315 ZZ	86	98.5	149	2	3.43
80	140	26	2	84 000	85 000	4 300	5 300	BL 216	BL 216 Z	BL 216 ZZ	89	95.5	131	2	1.61
	170	39	2.1	136 000	130 000	3 800	4 500	BL 316	BL 316 Z	BL 316 ZZ	91	104.5	159	2	4.08
85	150	28	2	93 000	93 000	4 000	5 000	BL 217	BL 217 Z	BL 217 ZZ	94	102	141	2	1.97
	180	41	3	147 000	145 000	3 600	4 300	BL 317	BL 317 Z	BL 317 ZZ	98	110.5	167	2.5	4.77
90	160	30	2	107 000	107 000	3 800	4 500	BL 218	BL 218 Z	BL 218 ZZ	99	107.5	151	2	2.43
	190	43	3	158 000	161 000	3 400	4 000	BL 318	BL 318 Z	BL 318 ZZ	103	117	177	2.5	5.45
95	170	32	2.1	121 000	123 000	3 600	4 300	BL 219	BL 219 Z	BL 219 ZZ	106	114	159	2	2.95
	200	45	3	169 000	178 000	2 800	3 600	BL 319	BL 319 Z	BL 319 ZZ	108	124	187	2.5	6.4
100	180	34	2.1	136 000	140 000	3 400	4 000	BL 220	BL 220 Z	BL 220 ZZ	111	121.5	169	2	3.54
105	190	36	2.1	148 000	157 000	3 200	3 800	BL 221	BL 221 Z	BL 221 ZZ	116	127.5	179	2	4.23
110	200	38	2.1	160 000	176 000	2 800	3 400	BL 222	—	—	121	—	189	2	4.84

Remark When using maximum ball bearings, please contact NSK.

MAGNETO BEARINGS

Bore Diameter 4 – 20 mm

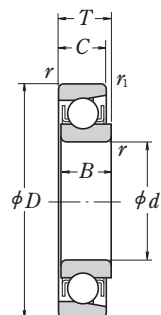

Outside Diameter Tolerance (Class N)

Units : μm

Nominal Outside Diameter D (mm)	Single Plane Mean Outside Diameter ΔD _{mp}					
			E Series		EN Series	
	Over	Incl.	High	Low	High	Low
—	10		+ 8	0	0	- 8
10	18		+ 8	0	0	- 8
18	30		+ 9	0	0	- 9
30	50		+11	0	0	-11

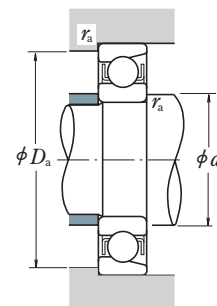

Dynamic Equivalent Load

$$P = XF_r + YF_a$$

$F_a/F_r \leq e$		$F_a/F_r > e$		e
X	Y	X	Y	
1	0	0.5	2.5	0.2

Boundary Dimensions (mm)					Basic Load Ratings (N)		Limiting Speeds (min ⁻¹)		Bearing Designations		Abutment and Fillet Dimensions (mm)			Mass (kg)
d	D	B,C,T	r min.	r ₁ min.	C _r	C _{0r}	Grease	Oil	E Series	EN Series	d _a min.	D _a max.	r _a max.	approx.
4	16	5	0.15	0.1	1 650	288	34 000	40 000	E 4	EN 4	5.2	14.8	0.15	0.005
5	16	5	0.15	0.1	1 650	288	34 000	40 000	E 5	EN 5	6.2	14.8	0.15	0.004
6	21	7	0.3	0.15	2 490	445	30 000	36 000	E 6	EN 6	8	19	0.3	0.011
7	22	7	0.3	0.15	2 490	445	30 000	36 000	E 7	EN 7	9	20	0.3	0.013
8	24	7	0.3	0.15	3 450	650	28 000	34 000	E 8	EN 8	10	22	0.3	0.014
9	28	8	0.3	0.15	4 550	880	24 000	30 000	E 9	EN 9	11	26	0.3	0.022
10	28	8	0.3	0.15	4 550	880	24 000	30 000	E 10	EN 10	12	26	0.3	0.021
11	32	7	0.3	0.15	4 400	845	22 000	26 000	E 11	EN 11	13	30	0.3	0.029
12	32	7	0.3	0.15	4 400	845	22 000	26 000	E 12	EN 12	14	30	0.3	0.028
13	30	7	0.3	0.15	4 400	845	22 000	26 000	E 13	EN 13	15	28	0.3	0.021
14	35	8	0.3	0.15	5 800	1 150	19 000	22 000	—	EN 14	16	33	0.3	0.035
15	35	8	0.3	0.15	5 800	1 150	19 000	22 000	E 15	EN 15	17	33	0.3	0.034
	40	10	0.6	0.3	7 400	1 500	17 000	20 000	BO 15	—	19	36	0.6	0.055
16	38	10	0.6	0.2	6 900	1 380	17 000	22 000	—	EN 16	20	34	0.6	0.049
17	40	10	0.6	0.3	7 400	1 500	17 000	20 000	L 17	—	21	36	0.6	0.051
	44	11	0.6	0.3	7 350	1 500	16 000	19 000	—	EN 17	21	40	0.6	0.080
	44	11	0.6	0.3	7 350	1 500	16 000	19 000	BO 17	—	21	40	0.6	0.080
18	40	9	0.6	0.2	5 050	1 030	17 000	20 000	—	EN 18	22	36	0.6	0.051
19	40	9	0.6	0.2	5 050	1 030	17 000	20 000	E 19	EN 19	23	36	0.6	0.049
20	47	12	1	0.6	11 000	2 380	14 000	17 000	E 20	EN 20	25	42	1	0.089
	47	14	1	0.6	11 000	2 380	14 000	17 000	L 20	—	25	42	1	0.101

- Remarks**
1. The outside diameters of Series E magneto bearings always have plus tolerances.
 2. Please contact NSK when using magneto bearings outside of the E Series.

2. EXTRA SMALL BALL BEARINGS AND MINIATURE BALL BEARINGS

INTRODUCTION C 054

BEARING TABLES

EXTRA SMALL BALL BEARINGS · MINIATURE BALL BEARINGS

Metric Series	Bore Diameter 1 – 9mm	C 058
With Flange	Bore Diameter 1 – 9mm	C 062
Inch Series	Bore Diameter 1.016 – 9.525mm	C 066
With Flange	Bore Diameter 1.191 – 9.525mm	C 068

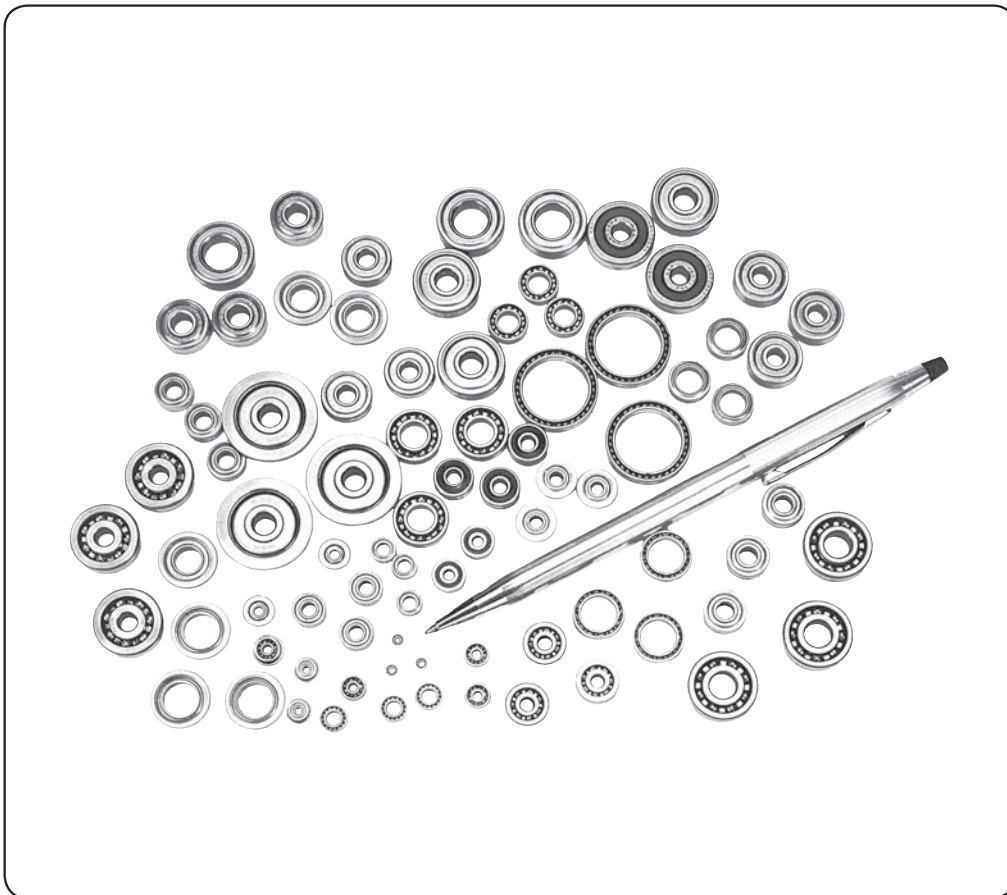

DESIGN AND TYPES

The size ranges of extra small and miniature ball bearings are shown in Table 1, and design/types and type designations are shown in Table 2. Types listed in the bearing tables are indicated by shading ■ in Table 2.

Table 1 Size Ranges of Bearings Units : mm

Series	Extra Small Ball Bearings	Miniature Ball Bearings
Metric	Outside diameter $D \geq 9$ Bore diameter $d < 10$	Outside diameter $D < 9$
Inch	Outside diameter $D \geq 9.525$ Bore diameter $d < 10$	Outside diameter $D < 9.525$

Please refer to NSK Miniature Ball Bearings (CAT. No. E126) for details.

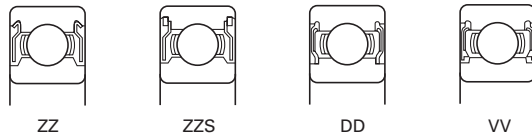

Table 2 Design/Types and Type Designations of Miniature and Extra Small Bearings

Design/Types	Type Designations				Remarks	
	Metric	Inch	Special			
			Metric	Inch		
	6○○	R	MR	—	Shielded and sealed bearings are available.	
 Thin section	—	—	SMT	—		
Single-Row Deep Groove Ball Bearings	 With flange	F6○○	FR	MF	—	Shielded and sealed bearings are available.
	 Extended inner ring	—	—	—	RW	Shielded bearings are available.
	 With flange and extended inner ring	—	—	—	FRW	Shielded bearings are available.
	 For synchro motors	—	—	—	SR00X00	Shielded bearings are available.
	 Pivot Ball Bearings	—	—	BCF	—	
 Thrust Ball Bearings	—	—	F	—		

Remark Other bearings, such as single-row angular contact ball bearings, are available.

TOLERANCES AND RUNNING ACCURACY

METRIC SERIES BEARINGS Table 7.2 (Pages A128 to A131)

The flange tolerances for metric series bearings are listed in Table 3.

Table 3 Flange Tolerances for Metric Flanged Bearings

(1) Tolerances of Flange Outside Diameter Units : m

Nominal Outer Ring Flange Outside Diameter D_1 (mm)		Deviation of a Single Outside Diameter of Outer Ring Flange ΔD_{1S}			
		Position Flange		Non-Position Flange	
over	incl.	high	low	high	low
-	6	+220	-36	0	-36
6	10	+220	-36	0	-36
10	18	+270	-43	0	-43
18	30	+330	-52	0	-52

(2) Flange Width Tolerances and Running Accuracies Units : m

Nominal Outside Diameter D (mm)		Deviation of a Single Outer Ring Flange Width ΔC_{1S}		Variation of Outer Ring Flange Width $V C_{1S}$			Perpendicularity of Outer Ring Outside Surface With Respect to the Flange Back Face S_{D1}			Axial Runout of Outer Ring Flange Back Face of Assembled Bearing S_{ea1}			
		Normal and Classes 6,5,4,2		Normal and Class 6	Class 5	Class 4	Class 2	Class 5	Class 4	Class 2	Class 5	Class 4	Class 2
over	incl.	high	low	max.			max.			max.			
2.5 ⁽¹⁾	6	Use the ΔB_s tolerance for d of the same bearing in the same class		Use the ΔVB_s tolerance for d of the same bearing in the same class	5	2.5	1.5	8	4	1.5	11	7	3
6	18				5	2.5	1.5	8	4	1.5	11	7	3
18	30				5	2.5	1.5	8	4	1.5	11	7	3

Notes ⁽¹⁾ Including 2.5 mm

INCH SERIES BEARINGS Table 7.2 (Pages A128 to A131)

The flange tolerances for inch design flanged bearings are listed in Table 7.9(2) (Pages A146 and A147).

INSTRUMENT BALL BEARINGS Table 7.9 (Pages A146 and A147)

RECOMMENDED FITS

Please refer to NSK Miniature Ball Bearings (CAT.No.E126).

INTERNAL CLEARANCES Table 8.11 (Page A169)

LIMITING SPEEDS

The limiting speeds listed in the bearing tables should be adjusted depending on bearing load conditions. In addition, higher speeds can be attained by making changes in the lubrication method, cage design, etc. Refer to Page A098 for detailed information.

EXTRA SMALL BALL BEARINGS · MINIATURE BALL BEARINGS

Metric Series
Bore Diameter 1 – 4 mm

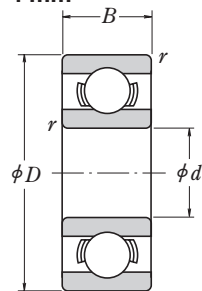

Open

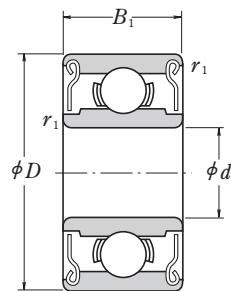

Shielded
ZZ · ZZ1

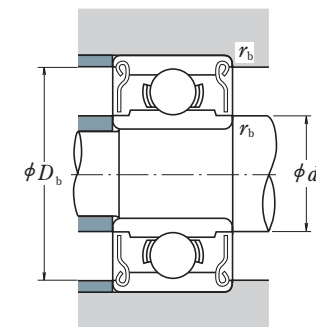
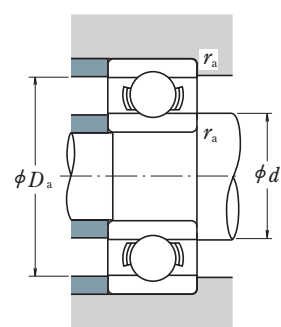

Boundary Dimensions (mm)						Basic Load Ratings (N)		Limiting Speeds (min ⁻¹)		Bearing Designations			Abutment and Fillet Dimensions (mm)						Mass (g)		
d	D	B	B ₁	r ⁽¹⁾ min.	r ₁ ⁽¹⁾ min.	C _r	C _{0r}	Grease Open Z · ZZ	Oil Open Z	Open	Shielded	Sealed	d _a min.	d _b max.	D _a max.	D _b min.	r _a max.	r _b max.	approx. Open	Shielded	
1	3	1	—	0.05	—	80	23	130 000	150 000	681	—	—	1.4	—	2.6	—	0.05	—	0.03	—	
	3	1.5	—	0.05	—	80	23	130 000	150 000	MR 31	—	—	1.4	—	2.6	—	0.05	—	0.04	—	
	4	1.6	—	0.1	—	138	35	100 000	120 000	691	—	—	1.8	—	3.2	—	0.1	—	0.09	—	
1.2	4	1.8	2.5	0.1	0.1	138	35	110 000	130 000	MR 41 X	MR 41 XZZ	—	2.0	1.9	3.2	3.5	0.1	0.1	0.10	0.14	
1.5	4	1.2	2	0.05	0.05	112	33	100 000	120 000	681 X	681 XZZ	—	1.9	2.1	3.6	3.6	0.05	0.05	0.07	0.11	
	5	2	2.6	0.15	0.15	237	69	85 000	100 000	691 X	691 XZZ	—	2.7	2.5	3.8	4.3	0.15	0.15	0.17	0.20	
	6	2.5	3	0.15	0.15	330	98	75 000	90 000	601 X	601 XZZ	—	2.7	3.0	4.8	5.4	0.15	0.15	0.33	0.38	
2	5	1.5	2.3	0.08	0.08	169	50	85 000	100 000	682	682 ZZ	—	2.6	2.7	4.4	4.2	0.08	0.08	0.12	0.17	
	5	2	2.5	0.1	0.1	187	58	85 000	100 000	MR 52 B	MR 52 BZZ	—	2.8	2.7	4.2	4.4	0.1	0.1	0.16	0.23	
	6	2.3	3	0.15	0.15	330	98	75 000	90 000	692	692 ZZ	—	3.2	3.0	4.8	5.4	0.15	0.15	0.28	0.38	
6	2.5	2.5	0.15	0.15	0.15	330	98	75 000	90 000	MR 62	MR 62 ZZ	—	3.2	3.0	4.8	5.2	0.15	0.15	0.30	0.29	
	7	2.5	3	0.15	0.15	385	127	63 000	75 000	MR 72	MR 72 ZZ	—	3.2	3.8	5.8	6.2	0.15	0.15	0.45	0.49	
	7	2.8	3.5	0.15	0.15	385	127	63 000	75 000	602	602 ZZ	—	3.2	3.8	5.8	6.2	0.15	0.15	0.51	0.58	
2.5	6	1.8	2.6	0.08	0.08	208	74	71 000	80 000	682 X	682 XZZ	—	3.1	3.7	5.4	5.4	0.08	0.08	0.23	0.29	
	7	2.5	3.5	0.15	0.15	385	127	63 000	75 000	692 X	692 XZZ	—	3.7	3.8	5.8	6.2	0.15	0.15	0.41	0.55	
	8	2.5	—	0.2	—	560	179	60 000	67 000	MR 82 X	—	—	4.1	—	6.4	—	0.2	—	0.56	—	
8	2.8	4	0.15	0.15	—	550	175	60 000	71 000	602 X	602 XZZ	—	3.7	4.1	6.8	7.0	0.15	0.15	0.63	0.83	
	3	6	2	2.5	0.1	0.1	208	74	71 000	80 000	MR 63	MR 63 ZZ	—	3.8	3.7	5.2	5.4	0.1	0.1	0.20	0.27
		7	2	3	0.1	0.1	390	130	63 000	75 000	683 A	683 AZZ	—	3.8	4.0	6.2	6.4	0.1	0.1	0.32	0.45
8		2.5	—	0.15	—	560	179	60 000	67 000	MR 83	—	—	4.2	—	6.8	—	0.15	—	0.54	—	
8	3	4	0.15	0.15	—	560	179	60 000	67 000	693	693 ZZ	—	4.2	4.3	6.8	7.3	0.15	0.15	0.61	0.83	
	9	2.5	4	0.2	0.15	570	187	56 000	67 000	MR 93	MR 93 ZZ	—	4.6	4.3	7.4	7.9	0.2	0.15	0.73	1.18	
	9	3	5	0.15	0.15	570	187	56 000	67 000	603	603 ZZ	—	4.2	4.3	7.8	7.9	0.15	0.15	0.87	1.45	
10	4	4	0.15	0.15	—	630	218	50 000	60 000	623	623 ZZ	—	4.2	4.3	8.8	8.0	0.15	0.15	1.65	1.66	
	13	5	5	0.2	0.2	1 300	485	40 000	48 000	633	633 ZZ	—	4.6	6.0	11.4	11.3	0.2	0.2	3.38	3.33	
	4	7	2	—	0.1	—	310	115	60 000	67 000	MR 74	—	—	4.8	—	6.2	—	0.1	—	0.22	—
7		—	2.5	—	0.1	255	107	60 000	71 000	—	MR 74 ZZ	—	—	4.8	—	6.3	—	0.1	—	0.29	—
8		2	3	0.15	0.1	395	139	56 000	67 000	MR 84	MR 84 ZZ	—	5.2	5.0	6.8	7.4	0.15	0.1	0.36	0.56	
9	2.5	4	(0.15)	(0.15)	640	225	53 000	63 000	684 A	684 AZZ	—	4.8	5.2	8.2	8.1	0.1	0.1	0.63	1.01		
10	3	4	0.2	0.15	710	270	50 000	60 000	MR 104 B	MR 104 BZZ	—	5.6	5.9	8.4	8.8	0.2	0.15	1.04	1.42		
11	4	4	0.15	0.15	960	345	48 000	56 000	694	694 ZZ	—	5.2	5.6	9.8	9.9	0.15	0.15	1.7	1.75		
12	4	4	0.2	0.2	960	345	48 000	56 000	604	604 ZZ	—	5.6	5.6	10.4	9.9	0.2	0.2	2.25	2.29		
13	5	5	0.2	0.2	1 300	485	40 000	48 000	624	624 ZZ	—	5.6	6.0	11.4	11.3	0.2	0.2	3.03	3.04		
16	5	5	0.3	0.3	1 700	670	36 000	43 000	634	634 ZZ1	—	6.0	7.5	14.0	13.8	0.3	0.3	5.24	5.21		

Note (1) Values in parentheses are not based on ISO 15.

Remark When using shielded bearings with a rotating outer ring, please contact NSK.

EXTRA SMALL BALL BEARINGS · MINIATURE BALL BEARINGS

Metric Series

Bore Diameter 5 – 9 mm

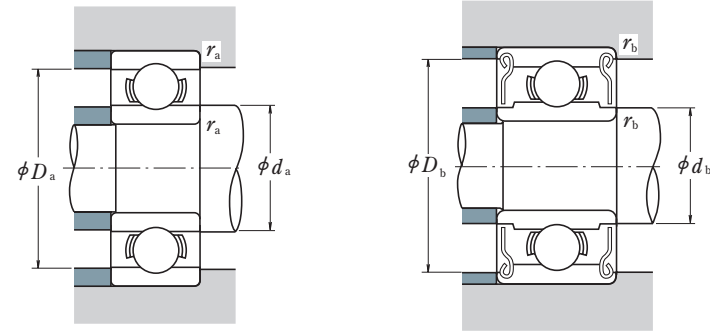
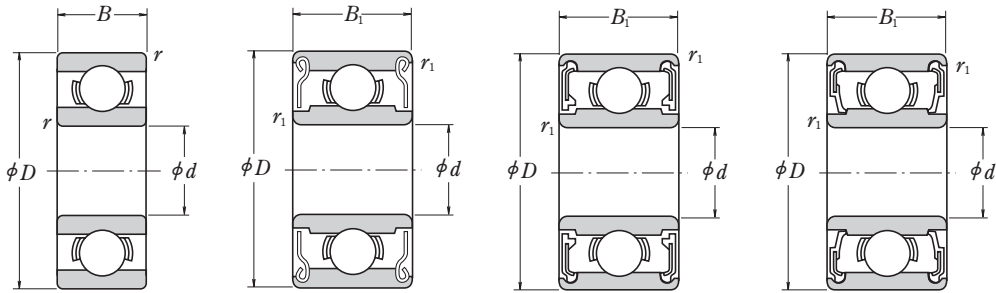

Open

Shielded
ZZ · ZZ1

Non-Contact
Sealed
VV

Contact
Sealed
DD

Boundary Dimensions (mm)						Basic Load Ratings (N)		Limiting Speeds (min ⁻¹)			Bearing Designations			Abutment and Fillet Dimensions (mm)						Mass (g)		
d	D	B	B ₁	r ⁽¹⁾ min.	r ₁ ⁽¹⁾ min.	C _r	C _{0r}	Open Z · ZZ V · VV	Oil D · DD	Grease Open Z	Open	Shielded	Sealed	d _a min.	d _b max.	D _a max.	D _b min.	r _a max.	r _b max.	Open	Shielded	
5	8	2	—	0.1	—	310	120	53 000	—	63 000	MR 85	—	—	5.8	—	7.2	—	0.1	—	0.26	—	
	8	—	2.5	—	0.1	278	131	53 000	—	63 000	—	MR 85 ZZ	—	5.8	—	7.4	—	0.1	—	—	0.34	
	9	2.5	3	0.15	0.15	430	168	50 000	—	60 000	MR 95	—	—	6.2	6.0	7.8	8.2	0.15	0.15	0.50	0.58	
	10	3	4	0.15	0.15	430	168	50 000	—	60 000	MR 105 ZZ	—	—	6.2	6.0	8.8	8.4	0.15	0.15	0.95	1.29	
	11	—	4	—	0.15	715	276	48 000	—	56 000	—	MR 115 ZZ	VV	—	6.3	—	9.8	—	0.15	0.15	—	1.49
	11	3	5	0.15	0.15	715	281	45 000	—	53 000	685	ZZ	—	6.2	6.2	9.8	9.9	0.15	0.15	1.2	1.96	
	13	4	4	0.2	0.2	1 080	430	43 000	40 000	50 000	695	ZZ	VV	DD	6.6	6.6	11.4	11.2	0.2	0.2	2.45	2.5
	14	5	5	0.2	0.2	1 330	505	40 000	38 000	50 000	605	ZZ	—	DD	6.6	6.9	12.4	12.2	0.2	0.2	3.54	3.48
	16	5	5	0.3	0.3	1 730	670	36 000	32 000	43 000	625	ZZ1	VV	DD	7.0	7.5	14.0	13.8	0.3	0.3	4.95	4.86
	19	6	6	0.3	0.3	2 340	885	32 000	30 000	40 000	635	ZZ1	VV	DD	7.0	8.5	17.0	16.5	0.3	0.3	8.56	8.34
6	10	2.5	3	0.15	0.1	495	218	45 000	—	53 000	MR 106	MR 106 ZZ1	—	7.2	7.0	8.8	9.3	0.15	0.1	0.56	0.68	
	12	3	4	0.2	0.15	715	292	43 000	40 000	50 000	MR 126	MR 126 ZZ	—	DD	7.6	7.2	10.4	10.9	0.2	0.15	1.27	1.74
	13	3.5	5	0.15	0.15	1 080	440	40 000	38 000	50 000	686 A	686 AZZ	VV	DD	7.2	7.4	11.8	11.7	0.15	0.15	1.91	2.69
	15	5	5	0.2	0.2	1 730	670	40 000	36 000	45 000	696	ZZ1	VV	DD	7.6	7.9	13.4	13.3	0.2	0.2	3.88	3.72
	17	6	6	0.3	0.3	2 260	835	38 000	34 000	45 000	606	ZZ	VV	DD	8.0	8.2	15.0	14.8	0.3	0.3	5.97	6.08
	19	6	6	0.3	0.3	2 340	885	32 000	30 000	40 000	626	ZZ1	VV	DD	8.0	8.5	17.0	16.5	0.3	0.3	8.15	7.94
	22	7	7	0.3	0.3	3 300	1 370	30 000	28 000	36 000	636	ZZ	VV	DD	8.0	10.5	20.0	19.0	0.3	0.3	14	14
	11	2.5	3	0.15	0.1	455	201	43 000	—	50 000	MR 117	MR 117 ZZ	—	—	8.2	8.0	9.8	10.5	0.15	0.1	0.62	0.72
	13	3	4	0.2	0.15	540	276	40 000	—	48 000	MR 137	MR 137 ZZ	—	—	8.6	9.0	11.4	11.6	0.2	0.15	1.58	2.02
	14	3.5	5	0.15	0.15	1 170	510	40 000	34 000	45 000	687	ZZ1	VV	DD	8.2	8.5	12.8	12.7	0.15	0.15	2.13	2.97
17	5	5	0.3	0.3	1 610	710	36 000	28 000	43 000	697	ZZ1	VV	DD	9.0	10.2	15.0	14.8	0.3	0.3	5.26	5.12	
19	6	6	0.3	0.3	2 340	885	36 000	32 000	43 000	607	ZZ1	VV	DD	9.0	9.1	17.0	16.5	0.3	0.3	7.67	7.51	
22	7	7	0.3	0.3	3 300	1 370	30 000	28 000	36 000	627	ZZ	VV	DD	9.0	10.5	20.0	19.0	0.3	0.3	12.7	12.9	
26	9	9	0.3	0.3	4 550	1 970	28 000	22 000	34 000	637	ZZ1	VV	DD	9.0	12.8	24.0	22.8	0.3	0.3	24	25	
8	12	2.5	3.5	0.15	0.1	545	274	40 000	—	48 000	MR 128	MR 128 ZZ1	—	9.2	9.0	10.8	11.3	0.15	0.1	0.71	0.97	
	14	3.5	4	0.2	0.15	820	385	38 000	32 000	45 000	MR 148	MR 148 ZZ	VV	DD	9.6	9.2	12.4	12.8	0.2	0.15	1.86	2.16
	16	4	5	0.2	0.2	1 610	710	36 000	28 000	43 000	688 A	688 AZZ1	VV	DD	9.6	10.2	14.4	14.2	0.2	0.2	3.12	4.02
	19	6	6	0.3	0.3	2 240	910	36 000	28 000	43 000	698	ZZ	VV	DD	10.0	10.0	17.0	16.5	0.3	0.3	7.23	7.18
	22	7	7	0.3	0.3	3 300	1 370	34 000	28 000	40 000	608	ZZ	VV	DD	10.0	10.5	20.0	19.0	0.3	0.3	12.1	12.2
	24	8	8	0.3	0.3	3 350	1 430	28 000	24 000	34 000	628	ZZ	VV	DD	10.0	12.0	22.0	20.5	0.3	0.3	17.2	17.4
	28	9	9	0.3	0.3	4 550	1 970	28 000	22 000	34 000	638	ZZ1	VV	DD	10.0	12.8	26.0	22.8	0.3	0.3	28.3	28.6
	17	4	5	0.2	0.2	1 330	665	36 000	24 000	43 000	689	ZZ1	VV	DD	10.6	11.5	15.4	15.2	0.2	0.2	3.53	4.43
	20	6	6	0.3	0.3	1 720	840	34 000	24 000	40 000	699	ZZ1	VV	DD	11.0	12.0	18.0	17.2	0.3	0.3	8.45	8.33
	24	7	7	0.3	0.3	3 350	1 430	32 000	24 000	38 000	609	ZZ	VV	DD	11.0	12.0	22.8	20.5	0.3	0.3	14.5	14.7
26	8	8	(0.6)	(0.6)	4 550	1 970	28 000	22 000	34 000	629	ZZ	VV	DD	11.0	12.8	24.0	22.8	0.3	0.3	19.5	19.3	
30	10	10	0.6	0.6	5 100	2 390	24 000	—	30 000	639	ZZ	VV	—	13.0	16.1	26.0	25.6	0.6	0.6	36.5	36	

Note ⁽¹⁾ Values in parentheses are not based on ISO 15.

Remarks 1. When using sealed or shielded bearings with a rotating outer ring, please contact NSK.

2. Bearings with snap rings are also available, please contact NSK for details.

EXTRA SMALL BALL BEARINGS · MINIATURE BALL BEARINGS

Metric Series With Flange
Bore Diameter 1 – 4 mm

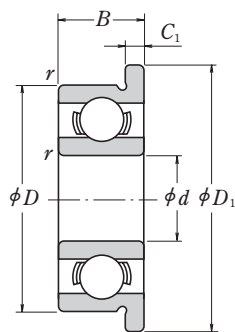

Open

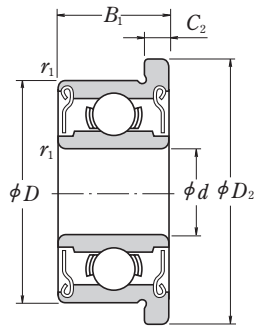

Shielded
ZZ · ZZ1

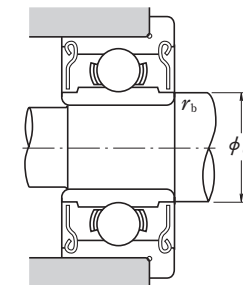
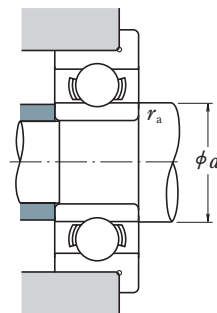

d	Boundary Dimensions (mm)										Basic Load Ratings (N)		Limiting Speeds (min ⁻¹)		Bearing Designations			Abutment and Fillet Dimensions (mm)				Mass (g)	
	D	D ₁	D ₂	B	B ₁	C ₁	C ₂	r ⁽¹⁾ min.	r ₁ ⁽¹⁾ min.	C _r	C _{0r}	Grease Open Z · ZZ	Oil Open Z	Open	Shielded	Sealed	d _a min.	d _b max.	r _a max.	r _b max.	approx. Open	Shielded	
1	3	3.8	—	1	—	0.3	—	0.05	—	80	23	130 000	150 000	F 681	—	—	1.4	—	0.05	—	0.04	—	
	4	5	—	1.6	—	0.5	—	0.1	—	140	36	100 000	120 000	F 691	—	—	1.8	—	0.1	—	0.14	—	
1.2	4	4.8	—	1.8	—	0.4	—	0.1	—	138	35	110 000	130 000	MF 41 X	—	—	2.0	—	0.1	—	0.12	—	
1.5	4	5	5	1.2	2	0.4	0.6	0.05	0.05	112	33	100 000	120 000	F 681 X	F 681 XZZ	—	1.9	2.1	0.05	0.05	0.09	0.14	
	5	6.5	6.5	2	2.6	0.6	0.8	0.15	0.15	237	69	85 000	100 000	F 691 X	F 691 XZZ	—	2.7	2.5	0.15	0.15	0.23	0.28	
	6	7.5	7.5	2.5	3	0.6	0.8	0.15	0.15	330	98	75 000	90 000	F 601 X	F 601 XZZ	—	2.7	3.0	0.15	0.15	0.42	0.52	
2	5	6.1	6.1	1.5	2.3	0.5	0.6	0.08	0.08	169	50	85 000	100 000	F 682	F 682 ZZ	—	2.6	2.7	0.08	0.08	0.16	0.22	
	5	6.2	6.2	2	2.5	0.6	0.6	0.1	0.1	187	58	85 000	100 000	MF 52 B	MF 52 BZZ	—	2.8	2.7	0.1	0.1	0.21	0.27	
	6	7.5	7.5	2.3	3	0.6	0.8	0.15	0.15	330	98	75 000	90 000	F 692	F 692 ZZ	—	3.2	3.0	0.15	0.15	0.35	0.48	
2.5	6	7.2	—	2.5	—	0.6	—	0.15	—	330	98	75 000	90 000	MF 62	—	—	3.2	—	0.15	—	0.36	—	
	7	8.2	8.2	2.5	3	0.6	0.6	0.15	0.15	385	127	63 000	75 000	MF 72	MF 72 ZZ	—	3.2	3.8	0.15	0.15	0.52	0.56	
	7	8.5	8.5	2.8	3.5	0.7	0.9	0.15	0.15	385	127	63 000	75 000	F 602	F 602 ZZ	—	3.2	3.1	0.15	0.15	0.60	0.71	
	8	9.2	—	2.5	—	0.6	—	0.2	—	560	179	60 000	67 000	F 682 X	F 682 XZZ	—	3.1	3.7	0.08	0.08	0.25	0.36	
3	7	8.1	8.1	2	3	0.5	0.8	0.1	0.1	390	130	63 000	75 000	F 692 X	F 692 XZZ	—	3.7	3.8	0.15	0.15	0.51	0.68	
	8	9.2	—	2.5	—	0.6	—	0.15	—	560	179	60 000	67 000	MF 82 X	—	—	4.1	—	0.2	—	0.62	—	
	8	9.5	9.5	2.8	4	0.7	0.9	0.15	0.15	550	175	60 000	71 000	F 602 X	F 602 XZZ	—	3.7	3.5	0.15	0.15	0.74	0.98	
	8	9.5	9.5	3	4	0.7	0.9	0.15	0.15	560	179	60 000	67 000	MF 63	MF 63 ZZ	—	3.8	3.7	0.1	0.1	0.27	0.33	
4	7	8.2	—	2	—	0.6	—	0.1	—	310	115	60 000	67 000	F 683 A	F 683 AZZ	—	3.8	4.0	0.1	0.1	0.37	0.53	
	7	—	8.2	—	2.5	—	0.6	—	0.1	255	107	60 000	71 000	MF 83	—	—	4.2	—	0.15	—	0.56	—	
	8	9.2	9.2	2	3	0.6	0.6	0.15	0.1	395	139	56 000	67 000	F 693	F 693 ZZ	—	4.2	4.3	0.15	0.15	0.70	0.97	
	9	10.5	10.5	3	5	0.7	1	0.15	0.15	570	187	56 000	67 000	MF 93	MF 93 ZZ	—	4.6	4.3	0.2	0.15	0.81	1.34	
	9	10.3	10.3	2.5	4	0.6	1	(0.15)	(0.15)	640	225	53 000	63 000	F 603	F 603 ZZ	—	4.2	4.3	0.15	0.15	1.0	1.63	
	10	11.5	11.5	4	4	1	1	0.15	0.15	630	218	50 000	60 000	F 623	F 623 ZZ	—	4.2	4.3	0.15	0.15	1.85	1.86	
	13	15	15	5	5	1	1	0.2	0.2	1 300	485	36 000	43 000	F 633	F 633 ZZ	—	4.6	6.0	0.2	0.2	3.73	3.59	
4	7	—	8.2	—	2.5	—	0.6	—	0.1	255	107	60 000	71 000	MF 74	—	—	4.8	—	0.1	—	0.29	—	
	8	9.2	9.2	2	3	0.6	0.6	0.15	0.1	395	139	56 000	67 000	MF 84	MF 84 ZZ	—	5.2	5.0	0.15	0.1	0.44	0.63	
	9	10.3	10.3	2.5	4	0.6	1	(0.15)	(0.15)	640	225	53 000	63 000	F 684	F 684 ZZ	—	4.8	5.2	0.1	0.1	0.70	1.14	
	10	11.2	11.6	3	4	0.6	0.8	0.2	0.15	710	270	50 000	60 000	MF 104 B	MF 104 BZZ	—	5.6	5.9	0.2	0.15	1.13	1.59	
	11	12.5	12.5	4	4	1	1	0.15	0.15	960	345	48 000	56 000	F 694	F 694 ZZ	—	5.2	5.6	0.15	0.15	1.91	1.96	
	12	13.5	13.5	4	4	1	1	0.2	0.2	960	345	48 000	56 000	F 604	F 604 ZZ	—	5.6	5.6	0.2	0.2	2.53	2.53	
	13	15	15	5	5	1	1	0.2	0.2	1 300	485	40 000	48 000	F 624	F 624 ZZ	—	5.6	6.0	0.2	0.2	3.38	3.53	
	16	18	18	5	5	1	1	0.3	0.3	1 730	670	36 000	43 000	F 634	F 634 ZZ1	—	6.0	7.5	0.3	0.3	5.73	5.62	

Note ⁽¹⁾ Values in parentheses are not based on ISO 15.

Remark When using shielded bearings with a rotating outer ring, please contact NSK.

EXTRA SMALL BALL BEARINGS · MINIATURE BALL BEARINGS

Metric Series With Flange
Bore Diameter 5 – 9 mm

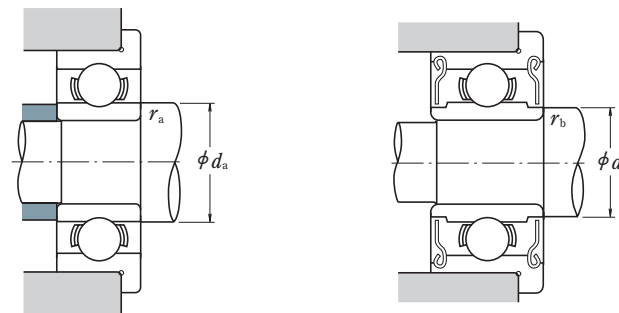
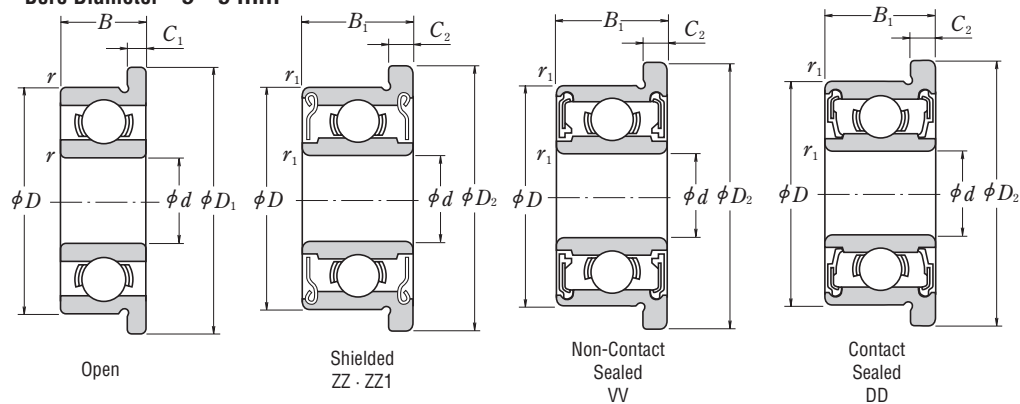

d	Boundary Dimensions (mm)									Basic Load Ratings (N)		Limiting Speeds (min ⁻¹)			Bearing Designations			Abutment and Fillet Dimensions (mm)				Mass (g)		
	D	D ₁	D ₂	B	B ₁	C ₁	C ₂	r min.	r ₁ min.	C _r	C _{0r}	Grease	Oil	Open	Shielded	Sealed	d _a min.	d _b max.	r _a max.	r _b max.	Open	Shielded		
5	8	9.2	—	2	—	0.6	—	0.1	—	310	120	53 000	—	63 000	MF 85	—	—	5.8	—	0.1	—	0.33	—	
	8	—	9.2	—	2.5	—	0.6	—	0.1	278	131	53 000	—	63 000	—	MF 85 ZZ	—	—	—	5.8	—	0.1	—	0.41
	9	10.2	10.2	2.5	3	0.6	0.6	0.15	0.15	430	168	50 000	—	60 000	MF 95	MF 95 ZZ1	—	—	6.2	6.0	0.15	0.15	0.59	0.66
	10	11.2	11.6	3	4	0.6	0.8	0.15	0.15	430	168	50 000	—	60 000	MF 105	MF 105 ZZ	—	—	6.2	6.0	0.15	0.15	1.05	1.46
	11	12.5	12.5	3	5	0.8	1	0.15	0.15	715	281	45 000	—	53 000	F 685	F 685 ZZ	—	—	6.2	6.2	0.15	0.15	1.37	2.18
	13	15	15	4	4	1	1	0.2	0.2	1 080	430	43 000	40 000	50 000	F 695	F 695 ZZ	VV	DD	6.6	6.6	0.2	0.2	2.79	2.84
	14	16	16	5	5	1	1	0.2	0.2	1 330	505	40 000	38 000	50 000	F 605	F 605 ZZ	—	DD	6.6	6.9	0.2	0.2	3.9	3.85
	16	18	18	5	5	1	1	0.3	0.3	1 730	670	36 000	32 000	43 000	F 625	F 625 ZZ1	VV	DD	7.0	7.5	0.3	0.3	5.37	5.27
	19	22	22	6	6	1.5	1.5	0.3	0.3	2 340	885	32 000	30 000	40 000	F 635	F 635 ZZ1	VV	DD	7.0	8.5	0.3	0.3	9.49	9.49
	6	10	11.2	11.2	2.5	3	0.6	0.6	0.15	0.1	495	218	45 000	—	53 000	MF 106	MF 106 ZZ1	—	—	7.2	7.0	0.15	0.1	0.65
12		13.2	13.6	3	4	0.6	0.8	0.2	0.15	715	292	43 000	40 000	50 000	MF 126	MF 126 ZZ	—	DD	7.6	7.2	0.2	0.15	1.38	1.94
13		15	15	3.5	5	1	1.1	0.15	0.15	1 080	440	40 000	38 000	50 000	F 686 A	F 686 AZZ	VV	DD	7.2	7.4	0.15	0.15	2.25	3.04
15		17	17	5	5	1.2	1.2	0.2	0.2	1 730	670	40 000	36 000	45 000	F 696	F 696 ZZ1	VV	DD	7.6	7.9	0.2	0.2	4.34	4.26
17		19	19	6	6	1.2	1.2	0.3	0.3	2 260	835	38 000	34 000	45 000	F 606	F 606 ZZ	VV	DD	8.0	8.2	0.3	0.3	6.58	6.61
19		22	22	6	6	1.5	1.5	0.3	0.3	2 340	885	32 000	30 000	40 000	F 626	F 626 ZZ1	VV	DD	8.0	8.5	0.3	0.3	9.09	9.09
22		25	25	7	7	1.5	1.5	0.3	0.3	3 300	1 370	30 000	28 000	36 000	F 636	F 636 ZZ	VV	DD	8.0	10.5	0.3	0.3	14.6	14.7
17		19	19	5	5	1.2	1.2	0.3	0.3	1 610	715	36 000	28 000	43 000	F 697	F 697 ZZ1	VV	DD	9.0	10.2	0.3	0.3	5.65	5.65
19		22	22	6	6	1.5	1.5	0.3	0.3	2 340	885	36 000	32 000	43 000	F 607	F 607 ZZ1	VV	DD	9.0	9.1	0.3	0.3	8.66	8.66
22		25	25	7	7	1.5	1.5	0.3	0.3	3 300	1 370	30 000	28 000	36 000	F 627	F 627 ZZ	VV	DD	9.0	10.5	0.3	0.3	14.2	14.2
8	12	13.2	13.6	2.5	3.5	0.6	0.8	0.15	0.1	545	274	40 000	—	48 000	MF 128	MF 128 ZZ1	—	—	9.2	9.0	0.15	0.1	0.82	1.15
	14	15.6	15.6	3.5	4	0.8	0.8	0.2	0.15	820	385	38 000	32 000	45 000	MF 148	MF 148 ZZ	VV	DD	9.6	9.2	0.2	0.15	2.09	2.39
	16	18	18	4	5	1	1.1	0.2	0.2	1 610	710	36 000	30 000	43 000	F 688 A	F 688 AZZ	VV	DD	9.6	10.2	0.2	0.2	3.54	4.47
	19	22	22	6	6	1.5	1.5	0.3	0.3	2 240	910	36 000	28 000	43 000	F 698	F 698 ZZ	VV	DD	10.0	10.0	0.3	0.3	8.35	8.3
	22	25	25	7	7	1.5	1.5	0.3	0.3	3 300	1 370	34 000	28 000	40 000	F 608	F 608 ZZ	VV	DD	10.0	10.5	0.3	0.3	13.4	13.5
	17	19	19	4	5	1	1.1	0.2	0.2	1 330	665	36 000	24 000	43 000	F 689	F 689 ZZ1	VV	DD	10.6	11.5	0.2	0.2	3.97	4.91
20	23	23	6	6	1.5	1.5	0.3	0.3	1 720	840	34 000	24 000	40 000	F 699	F 699 ZZ1	VV	DD	11.0	12.0	0.3	0.3	9.51	9.51	

Remark When using shielded bearings with a rotating outer ring, please contact NSK.

EXTRA SMALL BALL BEARINGS · MINIATURE BALL BEARINGS

Inch Series
Bore Diameter 1.016 – 9.525 mm

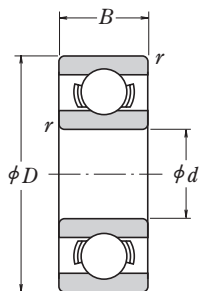

Open

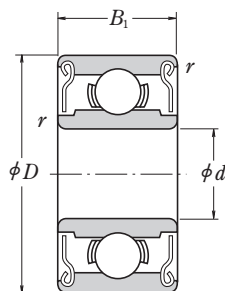

Shielded
ZZ · ZS

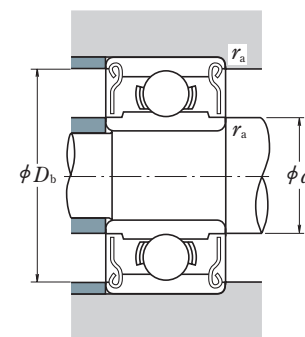
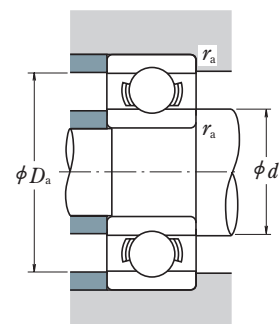

d	Boundary Dimensions (mm)				Basic Load Ratings (N)		Limiting Speeds (min ⁻¹)		Bearing	Designations	Abutment and Fillet Dimensions (mm)					Mass (g)	
	D	B	B ₁	r min.	C _r	C _{0r}	Grease Open Z · ZZ	Oil Open Z			Open	Shielded	d _a min.	d _b max.	D _a max.	D _b min.	r _a max.
1.016	3.175	1.191	—	0.1	80	23	130 000	150 000	R 09	—	1.9	—	2.3	—	0.1	0.04	—
1.191	3.967	1.588	2.380	0.1	138	35	110 000	130 000	R 0	R 0 ZZ	2.0	1.9	3.1	3.5	0.1	0.09	0.11
1.397	4.762	1.984	2.779	0.1	231	66	90 000	110 000	R 1	R 1 ZZ	2.2	2.3	3.9	4.1	0.1	0.15	0.19
1.984	6.350	2.380	3.571	0.1	310	108	67 000	80 000	R 1-4	R 1-4 ZZ	2.8	3.9	5.5	5.9	0.1	0.35	0.50
2.380	4.762	1.588	—	0.1	188	60	80 000	95 000	R 133	—	3.2	—	3.9	—	0.1	0.10	—
	4.762	—	2.380	0.1	143	52	80 000	95 000	R 133 ZZS	R 133 ZZS	—	3.0	—	4.2	0.1	—	0.13
	7.938	2.779	3.571	0.15	550	175	60 000	71 000	R 1-5	R 1-5 ZZ	3.6	4.1	6.7	7.0	0.15	0.60	0.72
3.175	6.350	2.380	2.779	0.1	283	95	67 000	80 000	R 144	R 144 ZZ	4.0	3.9	5.5	5.9	0.1	0.25	0.27
	7.938	2.779	3.571	0.1	560	179	60 000	67 000	R 2-5	R 2-5 ZZ	4.0	4.3	7.1	7.3	0.1	0.55	0.72
	9.525	2.779	3.571	0.15	640	225	53 000	63 000	R 2-6	R 2-6 ZZS	4.4	4.6	8.3	8.2	0.15	0.96	1.13
	9.525	3.967	3.967	0.3	630	218	56 000	67 000	R 2	R 2 ZZ	5.2	4.8	7.5	8.0	0.3	1.36	1.39
	12.700	4.366	4.366	0.3	640	225	53 000	63 000	R 2A	R 2A ZZ	5.2	4.6	10.7	8.2	0.3	3.3	3.23
3.967	7.938	2.779	3.175	0.1	360	149	53 000	63 000	R 155	R 155 ZZS	4.8	5.5	7.1	7.3	0.1	0.51	0.56
4.762	7.938	2.779	3.175	0.1	360	149	53 000	63 000	R 156	R 156 ZZS	5.6	5.5	7.1	7.3	0.1	0.39	0.42
	9.525	3.175	3.175	0.1	710	270	50 000	60 000	R 166	R 166 ZZ	5.6	5.9	8.7	8.8	0.1	0.81	0.85
	12.700	3.967	4.978	0.3	1 300	485	43 000	53 000	R 3	R 3 ZZ	6.8	6.5	10.7	11.2	0.3	2.21	2.79
6.350	9.525	3.175	3.175	0.1	420	204	48 000	56 000	R 168B	R 168 BZZ	7.2	7.0	8.7	8.9	0.1	0.58	0.62
	12.700	3.175	4.762	0.15	1 080	440	40 000	50 000	R 188	R 188 ZZ	7.6	7.4	11.5	11.6	0.15	1.53	2.21
	15.875	4.978	4.978	0.3	1 610	660	38 000	45 000	R 4B	R 4B ZZ	8.4	8.4	13.8	13.8	0.3	4.5	4.43
	19.050	5.558	7.142	0.4	2 620	1 060	36 000	43 000	R 4AA	R 4AA ZZ	9.4	9.0	16.0	16.6	0.4	7.48	9.17
7.938	12.700	3.967	3.967	0.15	540	276	40 000	48 000	R 1810	R 1810 ZZ	9.2	9.0	11.5	11.6	0.15	1.56	1.48
9.525	22.225	5.558	7.142	0.4	3 350	1 410	32 000	38 000	R 6	R 6 ZZ	12.6	11.9	19.2	20.0	0.4	9.02	11

- Remarks**
- When using shielded bearings with a rotating outer ring, please contact NSK.
 - Bearings with double shields (ZZ, ZZS) are also available with single shields (Z, ZS).

EXTRA SMALL BALL BEARINGS · MINIATURE BALL BEARINGS

Inch Series With Flange

Bore Diameter 1.191 – 9.525 mm

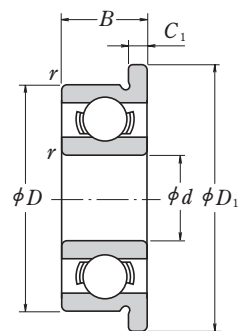

Open

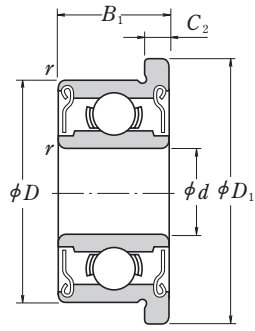

Shielded
ZZ · ZS

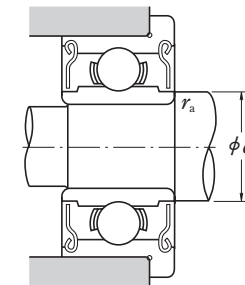
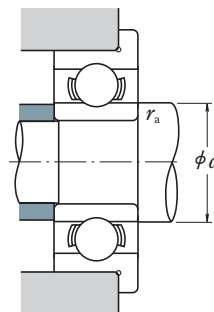

d	Boundary Dimensions (mm)							Basic Load Ratings (N)		Limiting Speeds (min ⁻¹)		Bearing Designations		Abutment and Fillet Dimensions (mm)			Mass (g)	
	D	D ₁	B	B ₁	C ₁	C ₂	r _{min.}	C _r	C _{0r}	Grease Open Z · ZZ	Oil Open Z	Open	Shielded	d _a min.	d _b max.	r _a max.	approx. Open	approx. Shielded
1.191	3.967	5.156	1.588	2.380	0.330	0.790	0.1	138	35	110 000	130 000	FR 0	FR 0 ZZ	2.0	1.9	0.1	0.11	0.16
1.397	4.762	5.944	1.984	2.779	0.580	0.790	0.1	231	66	90 000	110 000	FR 1	FR 1 ZZ	2.2	2.3	0.1	0.20	0.25
1.984	6.350	7.518	2.380	3.571	0.580	0.790	0.1	310	108	67 000	80 000	FR 1-4	FR 1-4 ZZ	2.8	3.9	0.1	0.41	0.58
2.380	4.762	5.944	1.588	—	0.460	—	0.1	188	60	80 000	95 000	FR 133	—	3.2	—	0.1	0.13	—
	4.762	5.944	—	2.380	—	0.790	0.1	143	52	80 000	95 000	—	FR 133 ZS	—	3.0	0.1	—	0.19
	7.938	9.119	2.779	3.571	0.580	0.790	0.15	550	175	60 000	71 000	FR 1-5	FR 1-5 ZZ	3.6	4.1	0.15	0.68	0.82
3.175	6.350	7.518	2.380	2.779	0.580	0.790	0.1	283	95	67 000	80 000	FR 144	FR 144 ZZ	4.0	3.9	0.1	0.31	0.35
	7.938	9.119	2.779	3.571	0.580	0.790	0.1	560	179	60 000	67 000	FR 2-5	FR 2-5 ZZ	4.0	4.3	0.1	0.62	0.81
	9.525	10.719	2.779	3.571	0.580	0.790	0.15	640	225	53 000	63 000	FR 2-6	FR 2-6 ZZS	4.4	4.6	0.15	1.04	1.25
	9.525	11.176	3.967	3.967	0.760	0.760	0.3	630	218	56 000	67 000	FR 2	FR 2 ZZ	5.2	4.8	0.3	1.51	1.55
3.967	7.938	9.119	2.779	3.175	0.580	0.910	0.1	360	149	53 000	63 000	FR 155	FR 155 ZS	4.8	5.5	0.1	0.59	0.67
4.762	7.938	9.119	2.779	3.175	0.580	0.910	0.1	360	149	53 000	63 000	FR 156	FR 156 ZS	5.6	5.5	0.1	0.47	0.53
	9.525	10.719	3.175	3.175	0.580	0.790	0.1	710	270	50 000	60 000	FR 166	FR 166 ZZ	5.6	5.9	0.1	0.90	0.98
	12.700	14.351	4.978	4.978	1.070	1.070	0.3	1 300	485	43 000	53 000	FR 3	FR 3 ZZ	6.8	6.5	0.3	2.97	3.09
6.350	9.525	10.719	3.175	3.175	0.580	0.910	0.1	420	204	48 000	56 000	FR 168B	FR 168 BZZ	7.2	7.0	0.1	0.66	0.75
	12.700	13.894	3.175	4.762	0.580	1.140	0.15	1 080	440	40 000	50 000	FR 188	FR 188 ZZ	7.6	7.4	0.15	1.64	2.49
	15.875	17.526	4.978	4.978	1.070	1.070	0.3	1 610	660	38 000	45 000	FR 4B	FR 4B ZZ	8.4	8.4	0.3	4.78	4.78
7.938	12.700	13.894	3.967	3.967	0.790	0.790	0.15	540	276	40 000	48 000	FR 1810	FR 1810 ZZ	9.2	9.0	0.15	1.71	1.63
9.525	22.225	24.613	7.142	7.142	1.570	1.570	0.4	3 350	1 410	32 000	38 000	FR 6	FR 6 ZZ	12.6	11.9	0.4	10.1	12.1

- Remarks**
1. When using shielded bearings with a rotating outer ring, please contact NSK.
 2. Bearings with double shields (ZZ, ZS) are also available with single shields (Z, ZS).

3. ANGULAR CONTACT BALL BEARINGS

INTRODUCTION C 072

TECHNICAL DATA

Free Space of Angular Contact Ball Bearings..... C 078

**Dynamic Equivalent Load of
Triplex Angular Contact Ball Bearings**..... C 080

**Angular Clearances in Double-Row
Angular Contact Ball Bearings**..... C 082

**Relationship Between Radial
and Axial Clearances in Double-Row
Angular Contact Ball Bearings**..... C 084

BEARING TABLES

Single-Row and Matched Angular Contact Ball Bearings

Bore Diameter 10 – 200 mm..... C 086

Double-Row Angular Contact Ball Bearings Open, Shielded, and Sealed Types

Bore Diameter 10 – 85 mm C 106

Four-Point-Contact Ball Bearings

Bore Diameter 30 – 200 mm..... C 110



DESIGN, TYPES, AND FEATURES

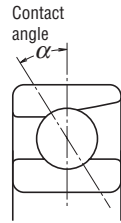

SINGLE-ROW ANGULAR CONTACT BALL BEARINGS

Single-row angular contact ball bearings have a contact angle allowing them to sustain significant axial loads in one direction together with radial loads. Because of their design, when a radial load is applied, an axial force component is produced; therefore, two or more opposed bearings must be used.

Since the rigidity of single-row angular contact ball bearings can be increased by preloading, they are often used in the main spindles of machine tools where high running accuracy is required (refer to Chapter 9 Preload on Page A192 for more information).

Usually, the cages for angular contact ball bearings with a contact angle of 30° (designation **A**) or 40° (designation **B**) are made in accordance with Table 1, but depending on the application, machined synthetic-resin cages or molded polyamide-resin cages may also be used. The basic load ratings given in the bearing tables are based on standard cages.

Though the figures in the bearing tables on Pages C086 to C101 for bearing bore diameters of 10 to 120 show bearings with single-shoulder inner rings, dual-shoulder bearings are also available. Please consult NSK for more detailed information.

Table 1 Features of Single-Row Angular Contact Ball Bearings

Cage	Material	Steel	Nylon 46		L-PPS resin	Brass	
		Method	Molded		Molded	Machined	
Spec.	Designation	W	TYN	T85	T7	Omitted	MR
Features	High Load Capacity	◎	○	◎	◎	○	◎
	High-Speed	△	◎	○	○	△	○
	High-Temperature	◎	△	△	◎	◎	◎
	Vibration	△	△	△	△	◎	◎

◎ Excellent ○ Good △ Fair

In addition, bearings with the same serial number will have different load ratings if the type of cage or number of balls are different.

Angular contact ball bearings with contact angles of 15° (designation **C**) and 25° (designation **A5**) are primarily for high precision or high-speed applications, and molded polyamide cages (designation TYN) or machined-brass cages or synthetic resin cages (designation T) are used.

The maximum operating temperature of molded polyamide cages is 150°C.

MATCHED ANGULAR CONTACT BALL BEARINGS

The types and features of matched angular contact ball bearings are shown in Table 2.

Table 2 Types and Features of Matched Angular Contact Ball Bearings

Figure	Arrangement	Features
	Back-to-Back (DB) (Example) 7208 A DB	Radial loads and axial loads in both directions can be sustained. Since the distance between the effective load centers a_0 is large, this type is suitable if moments are applied.
	Face-to-Face (DF) (Example) 7208 B DF	Radial loads and axial loads in both directions can be sustained. Compared with the DB Type, the distance between the effective load centers is small, so the capacity to sustain moments is inferior.
	Tandem (DT) (Example) 7208 A DT	Radial loads and axial loads in one direction can be sustained. Since two bearings share the axial load, this arrangement is used when the load in one direction is heavy.

NSKHPS™ ANGULAR CONTACT BALL BEARINGS

NSKHPS bearings feature high capacity, high limiting speed, and highly accurate universal matching. Molded polyamide cages are standard for the NSKHPS type.

ANGULAR CONTACT BALL BEARINGS

Formulation of Bearing Designations

Single-Row Matched Angular Contact Ball Bearings

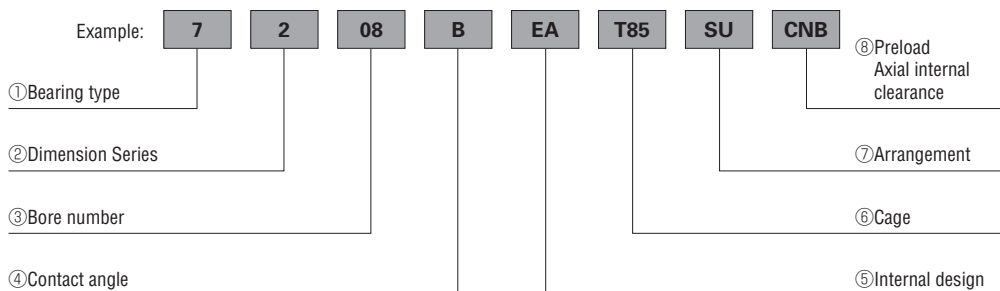

- ① Bearing type: 7 : Single-row angular contact ball bearings, matched angular contact ball bearings
- ② Dimension Series: 2 : 02 Series, 3 : 03 Series, 9 : 19 Series, 0 : 10 Series
- ③ Bore number: Less than 03, Bearing bore 00 : 10mm, 01 : 12mm, 02 : 15mm, 03 : 17mm
Over 04, Bearing bore Bore number × 5 (mm)
- ④ Contact angle: C : 15°, A5 : 25°, A : 30°, B : 40°
- ⑤ Internal design: EA : High Load Capacity
- ⑥ Cage: W : Pressed steel Cage, T85 : Machined brass cage (ball-guided),
No designation : Machined brass cage (inner ring guided), TYN : Polyamide resin cage,
T85 : Polyamide 46 resin cage, T7 : L-PPS resin cage
- ⑦ Arrangement: SU: Universal arrangement (single-row), DU : Universal arrangement (double-row),
DB : Back-to-back arrangement, DF : Face-to-face arrangement, DT : Tandem arrangement
- ⑧ Preload / Axial internal clearance: EL : Extra light preload, L : Light preload, M : Medium preload, H : Heavy preload
Omitted : CN clearance, C3 : Clearance greater than CN, C4 : Clearance greater than C3,
CNB : CN Clearance equivalent (universal arrangement)

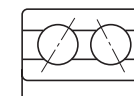

DOUBLE-ROW ANGULAR CONTACT BALL BEARINGS

Double-row angular contact ball bearings are essentially a back-to-back mounting of two single-row angular contact ball bearings, but their inner and outer rings are each integrated into one. These bearings can sustain axial loads in both directions and offer good capacity for sustaining moment loads. They are often used as fixed-end bearings and contain cages made of pressed steel.

Formulation of Bearing Designations

Double-Row Angular Contact Ball Bearings

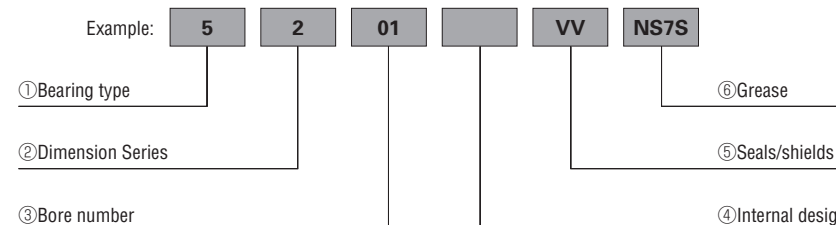

- ① Bearing type: 5 : Double-row angular contact ball bearings
- ② Dimension Series: 2 : 02 Series 3 : 03 Series
- ③ Bore number: 03 and under: 00 : 10mm, 01 : 12mm, 02 : 15mm, 03 : 17mm
04 and over: Bore diameter bore number × 5 (mm)
- ④ Internal design: ZZ: Steel shield on both sides, DDU: Rubber contact seal on both sides VV: Rubber noncontact seal on both sides
- ⑤ Seals/shields: Z: Steel shield on one sides, DU: Rubber contact seal on one side, V: Rubber non-contact seal on one side
- ⑥ Grease*: NS7: NS HI-LUBE

* A grease code is required when using shields or seals on both sides.



Four-Point-Contact Ball Bearings

The inner ring is split radially into two pieces. This design allows one bearing to sustain significant axial loads in either direction.

The contact angle is 35°, so axial load capacity is high. These bearings are suitable for carrying pure axial loads or combined loads where axial loads are high.

The cages are made of machined brass.

Formulation of Bearing Designations

Four-Point-Contact Ball Bearings

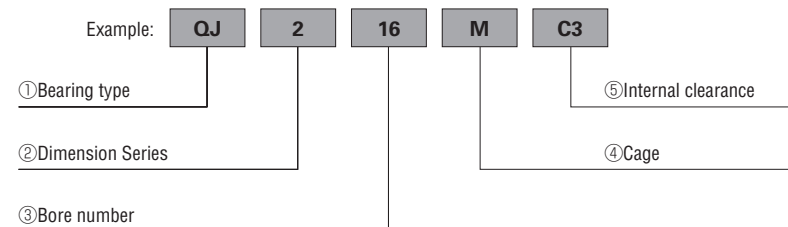

- ① Bearing type: QJ : Four-point contact ball bearings
- ② Dimension Series: 10 : 10 Series, 2 : 02 Series, 3 : 03 Series
- ③ Bore number: Less than 03, Bearing bore 00 : 10mm, 01 : 12mm, 02 : 15mm, 03 : 17mm
Over 04, Bearing bore Bore number × 5 (mm)
- ④ Cage: M : Machined-brass Cage (outer ring guided)
- ⑤ Internal clearance: Omitted : CN clearance,
C3 : Clearance greater than CN, C4 : Clearance greater than C3

PRECAUTIONS FOR USE OF ANGULAR CONTACT BALL BEARINGS

Under severe operating conditions where speed and temperature are close to bearing limits, lubrication is marginal, and vibration and moment loads are heavy, angular contact ball bearings may not be suitable, particularly when using certain types of cages. In such cases, please consult with NSK beforehand.

If the load on angular contact ball bearings becomes too small, or if the ratio of the axial and radial loads for matched bearings exceeds 'e' (listed in the bearing tables) during operation, slippage occurs between the balls and raceways, which may result in smearing. This is especially true with large bearings since the weight of the balls and cage is high. If such load conditions are expected, please consult with NSK for bearing selection.

TOLERANCES AND RUNNING ACCURACY

- SINGLE-ROW ANGULAR CONTACT BALL BEARINGS** Table 7.2 (Pages A128 to A131)
- NSKHPS ANGULAR CONTACT BALL BEARINGS**
Tolerances: Class 6,
Running Accuracy: Class 5 Table 7.2 (Pages A128 to A131)
- MATCHED ANGULAR CONTACT BALL BEARINGS** Table 7.2 (Pages A128 to A131)
- DOUBLE-ROW ANGULAR CONTACT BALL BEARINGS** Table 7.2 (Pages A128 to A131)
- FOUR-POINT-CONTACT BALL BEARINGS** Table 7.2 (Pages A128 to A131)

RECOMMENDED FITS

- SINGLE-ROW ANGULAR CONTACT BALL BEARINGS AND NSKHPS ANGULAR CONTACT BALL BEARINGS** Table 8.3 (Page A164)
Table 8.5 (Page A165)
- MATCHED ANGULAR CONTACT BALL BEARINGS** .. Table 8.3 (Page A164)
Table 8.5 (Page A165)
- DOUBLE-ROW ANGULAR CONTACT BALL BEARINGS** Table 8.3 (Page A164)
Table 8.5 (Page A165)
- FOUR-POINT-CONTACT BALL BEARINGS** Table 8.3 (Page A164)
Table 8.5 (Page A165)

INTERNAL CLEARANCES

MATCHED ANGULAR CONTACT BALL BEARINGS Table 8.18 (Page A174)

Matched angular contact ball bearings with precision classes over P5 are primarily used in the main spindles of machine tools; as such, they are used with a preload for rigidity. For ease of selection, internal clearances are adjusted to produce Very Light, Light, Medium, and Heavy preloads. These bearings also use a special fitting; please refer to Tables 9.1 and 9.5 (Pages A194 and A197) for more information.

The clearance (or preload) of matched bearings is obtained by axially tightening a pair of bearings till the side faces of their inner or outer rings are pressed against each other.

NSKHPS ANGULAR CONTACT BALL BEARINGS

Axial Internal Clearance (Measured Clearances) Units : μm

Nominal Bore Diameter d (mm)		Axial Internal Clearance			
		CNB		GA	
over	incl.	min.	max.	min.	max.
12	18	17	25	-2	6
18	30	20	28		
30	50	24	32		
50	80	29	41	-3	9

DOUBLE-ROW ANGULAR CONTACT BALL BEARINGS

For the clearance in double-row angular contact ball bearings, please consult with NSK.

FOUR-POINT CONTACT BALL BEARINGS Table 8.19 (Page A174)

LIMITING SPEEDS (Grease/Oil)

Limiting speeds (grease/oil) listed in the bearing tables are for matched angular contact ball bearings with standard cages. Please consult NSK regarding bearings with optional cages, as limiting speeds (grease/oil) may differ from those listed. For example, limiting speeds (grease/oil) of machined cages (no designation) are 1.25 times higher than pressed cages.

The limiting speeds of bearings with contact angles of 15° (designation **C**) and 25° (designation **A5**) are for bearings with a precision class of P5 or better with machined synthetic resin cages (T) or molded polyamide cages (TYN).

The limiting speeds listed in the bearing tables should be adjusted depending on bearing load conditions. In addition, higher speeds are attainable by making changes in the lubrication method, cage design, etc; refer to Page A098 for detailed information.

ANGULAR CONTACT BALL BEARINGS**TECHNICAL DATA****Free Space of Angular Contact Ball Bearings**

Angular contact ball bearings are used in various components, such as spindles of machine tools, vertical pump motors, and worm gear reducers.

Grease lubrication is usually used with these bearings; however, such grease lubrication may affect the bearing in terms of temperature rise or durability. To allow a bearing to demonstrate its full performance, the bearing must be filled with the proper amount of a suitable grease. To do so, knowledge of the bearing's free space is critical.

Various angular contact ball bearings are available independent of the numerous combinations of bearing series, contact angle, and cage type. The free space of frequently used bearings are listed below. Table 1 shows the free space of a bearing with a pressed cage for general use and Table 2 shows that of bearings with a high-tension brass machined cage. The contact angle designations A, B, and C in each table refer to the nominal contact angles of 30°, 40°, and 15° for each bearing.

Table 1 Free Space of Angular Contact Ball Bearings (1)
(With Pressed Steel Cages)

Units: cm³

Bearing Bore No.	Bearing Free Space			
	Bearing Series — Contact Angle Designation			
	72-A	72-B	73-A	73-B
00	1.5	1.4	2.9	2.8
01	2.1	2.0	3.7	3.5
02	2.8	2.7	4.8	4.6
03	3.7	3.6	6.2	5.9
04	6.2	5.9	8.4	8.0
05	7.8	7.4	13	12
06	12	11	20	19
07	16	15	26	24
08	20	19	36	34
09	25	24	48	45
10	28	27	63	60

Table 2 Free Space of Angular Contact Ball Bearings (2)
(With High-Tension Brass Machined Cages)

Units: cm³

Bearing Bore No.	Bearing Free Space				
	Bearing Series — Contact Angle Designation				
	70-C	72-A 72-C	72-B	73-A 73-C	73-B
00	0.9	1.0	1.0	2.2	2.1
01	0.9	1.6	1.6	2.5	2.5
02	1.2	1.9	1.9	3.4	3.3
03	1.6	2.7	2.7	4.6	4.4
04	3.0	4.7	4.2	6.1	5.9
05	3.5	6.0	5.3	9.2	9.0
06	4.3	8.5	8.1	14	13
07	6.5	12	11	18	17
08	8.3	14	14	25	24
09	10	18	17	34	33
10	11	20	20	45	44
11	16	26	25	57	55
12	17	33	31	71	69
13	18	38	37	87	83
14	24	43	42	107	103
15	24	47	45	129	123
16	34	58	57	152	146
17	37	71	70	179	172
18	44	88	85	207	201
19	44	105	105	261	244
20	47	127	127	282	278

Dynamic Equivalent Load of Triplex Angular Contact Ball Bearings

Three separate single-row bearings may be used side by side as shown in the figure when angular contact ball bearings are used to carry a large axial load. There are three combination patterns, which are expressed by combination designations DBD, DFD, and DTD.

As in the case of single-row and double-row bearings, the dynamic equivalent load, which is determined from the radial and axial loads acting on a bearing, is used to calculate the fatigue life for these combined bearings.

Assuming the dynamic equivalent radial load as P_r , the radial load as F_r , and axial load as F_a , the relationship between the dynamic equivalent radial load and bearing load may be approximated as follows:

$$P_r = XF_r + YF_a \quad \text{..... (1)}$$

where X : Radial load factor
 Y : Axial load factor } See Table 1

The axial load factor varies with contact angle. A small contact angle in an angular contact ball bearing varies substantially when axial load increases.

A change in the contact angle can be expressed by the ratio between the basic static load rating C_{0r} and axial load F_a . Axial load factors corresponding to this ratio at a contact angle of 15° are shown in Table 1. If angular contact ball bearings have contact angles of 25°, 30° and 40°, the effect of change in the contact angle on the axial load factor may be ignored and thus the axial load factor is assumed as constant.

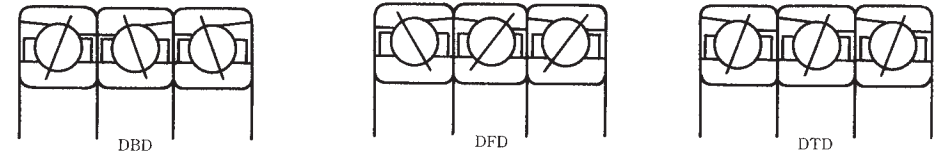

Table 1 Factors X and Y for Triplex Angular Contact Ball Bearing

Contact Angle α	j	$\frac{C_{0r}}{jF_a}$	$\frac{F_a}{F_r} \leq e$		$\frac{F_a}{F_r} > e$		e	Basic Load Rating of 3-Row Ball Bearings	
			X	Y	X	Y		C_r	C_{0r}
15°	1.5	5	1	0.64	0.58	1.46	0.51	2.16 times that of a single bearing	3 times that of a single bearing
		10		0.70		1.61			
		15		0.74		1.70			
		20		0.76		1.75			
		25		0.78		1.81			
		30		0.80		1.83			
40	0.83	1.91	0.39						
25°	—	—	1	0.48	0.54	1.16	0.68		
30°	—	—	1	0.41	0.52	1.01	0.80		
40°	—	—	1	0.29	0.46	0.76	1.14		
15°	3	5	1	2.28	0.95	2.37	0.51	2.16 times that of a single bearing	3 times that of a single bearing
		10		2.51		2.61			
		15		2.64		2.76			
		20		2.73		2.85			
		25		2.80		2.93			
		30		2.85		2.98			
40	2.98	3.11	0.39						
25°	—	—	1	1.70	0.88	1.88	0.68		
30°	—	—	1	1.45	0.84	1.64	0.80		
40°	—	—	1	1.02	0.76	1.23	1.14		
15°	1	5	1	0	0.44	1.10	0.51	2.16 times that of a single bearing	3 times that of a single bearing
		10				1.21			
		15				1.28			
		20				1.32			
		25				1.36			
		30				1.38			
40	1.44	0.39							
25°	—	—	1	0	0.41	0.87	0.68		
30°	—	—	1	0	0.39	0.76	0.80		
40°	—	—	1	0	0.35	0.57	1.14		

Arrangement	Load Direction
3-row matched stack, axial load is supported by 2 rows. (Symbol DBD or DFD)	<p>DBD</p>
	<p>DFD</p>
3-row matched stack, axial load is supported by 1 row. (Symbol DBD or DFD)	<p>DBD</p>
	<p>DFD</p>
3-row tandem matched stack (Symbol DTD)	<p>DTD</p>

Angular Clearances in Double-Row Angular Contact Ball Bearings

The angular clearance for double-row bearings is defined in exactly the same way as for single-row bearings; i.e., with one of the bearing rings fixed, the angular clearance refers to the greatest possible angular displacement of the axis of the other ring.

Since the angular clearance is the greatest total relative displacement of the two ring axes, it is twice the possible angle of inner and outer ring movement (the maximum angular displacement in one direction from the center without creating a moment).

The relationship between axial and angular clearance for double-row angular contact ball bearings is given by Equation (1) below:

$$\Delta_a = 2m_0 \left\{ \sin\alpha_0 + \frac{\theta R_i}{2m_0} - \sqrt{1 - \left(\cos\alpha_0 + \frac{\theta l}{4m_0} \right)^2} \right\} \quad (1)$$

- where Δ_a : Axial clearance (mm)
- m_0 : Distance between inner and outer ring groove curvature centers
- $m_0 = r_o + r_i - D_w$ (mm)
- r_o : Outer ring groove radius (mm)
- r_i : Inner ring groove radius (mm)
- α_0 : Initial contact angle (°)
- θ : Angular clearance (rad)
- R_i : Distance between shaft center and inner ring groove curvature center (mm)
- l : Distance between left and right groove centers of inner ring (mm)

The above equation is shown plotted in Fig. 1 for Series 52, 53, 32, and 33 double-row angular contact ball bearings.

The relationship between radial clearance Δ_r and axial clearance Δ_a for double-row angular contact ball bearings is listed on pages C086 and C087. Fig. 2 shows the relationship between angular clearance θ and radial clearance Δ_r based on equations from those pages.

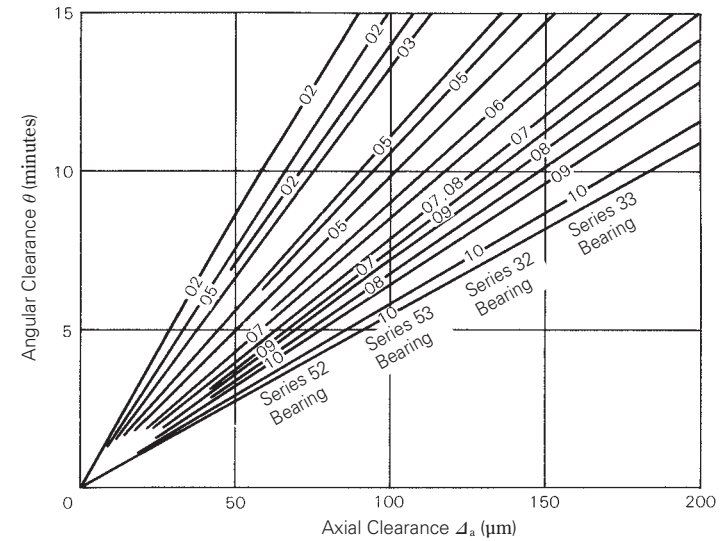

Fig. 1 Relationship Between Axial and Angular Clearances

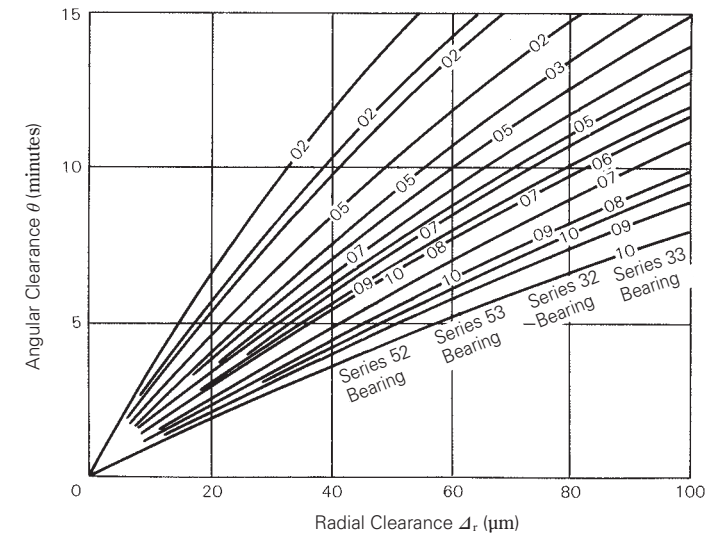

Fig. 2 Relationship Between Radial and Angular Clearances

Relationship Between Radial and Axial Clearances in Double-Row Angular Contact Ball Bearings

The relationship between the radial and axial internal clearances in double-row angular contact ball bearings can be determined geometrically as shown in Fig. 1 below.

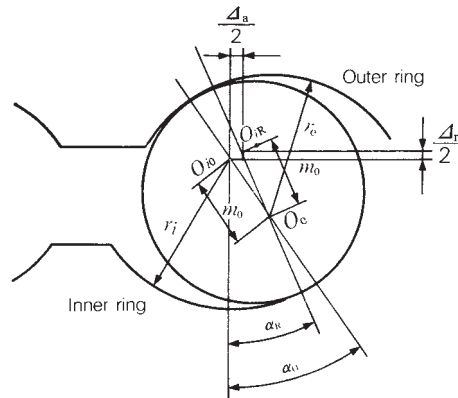

Fig. 1

- where Δ_r : Radial clearance (mm)
- Δ_a : Axial clearance (mm)
- α_o : Initial contact angle, inner or outer ring displaced axially
- α_R : Initial contact angle, inner or outer ring displaced radially
- O_o : Center of outer ring groove curvature (outer ring fixed)
- O_i : Center of inner ring groove curvature (inner ring displaced axially)
- O_{iR} : Center of inner ring groove curvature (inner ring displaced radially)
- m_o : Distance between inner and outer ring groove-curvature centers
 $m_o = r_i + r_o - D_w$
- D_w : Ball diameter (mm)
- r_i : Radius of inner ring groove (mm)
- r_o : Radius of outer ring groove (mm)

The following relations can be derived from Fig. 1:

$$m_o \sin \alpha_o = m_o \sin \alpha_R + \frac{\Delta_a}{2} \quad (1)$$

$$m_o \cos \alpha_o = m_o \cos \alpha_R - \frac{\Delta_r}{2} \quad (2)$$

since $\sin^2 \alpha_o = 1 - \cos^2 \alpha_o$,
 $(m_o \sin \alpha_o)^2 = m_o^2 - (m_o \cos \alpha_o)^2 \quad (3)$

By combining Equations (1), (2), and (3), we obtain the following:

$$\left(m_o \sin \alpha_R + \frac{\Delta_a}{2}\right)^2 = m_o^2 - \left(m_o \cos \alpha_R - \frac{\Delta_r}{2}\right)^2 \quad (4)$$

$$\therefore \Delta_a = 2 \sqrt{m_o^2 - \left(m_o \cos \alpha_R - \frac{\Delta_r}{2}\right)^2} - 2m_o \sin \alpha_R \quad (5)$$

α_R is 25° for Series 52 and 53 bearings and 32° for Series 32 and 33 bearings. If we set α_R equal to 0°, Equation (5) becomes:

$$\begin{aligned} \Delta_a &= 2 \sqrt{m_o^2 - \left(m_o - \frac{\Delta_r}{2}\right)^2} \\ &= 2 \sqrt{m_o \Delta_r - \frac{\Delta_r^2}{4}} \end{aligned}$$

However, $\frac{\Delta_r^2}{4}$ is negligible.

$$\therefore \Delta_a \doteq 2m_o^{1/2} \Delta_r^{1/2} \quad (6)$$

This is identical to the relationship between the radial and axial clearances in single-row deep groove ball bearings.

The value of m_o is dependent on the inner and outer ring groove radii. The relation between Δ_r and Δ_a , as given by Equation (5), is shown in Figs. 2 and 3 for Series 52, 53, 32, and 33 double-row angular contact ball bearings. When the clearance range is small, axial clearance is given approximately by the following:

$$\Delta_a \doteq \Delta_r \cot \alpha_R \quad (7)$$

However, when the clearance is relatively large, (when $\Delta_r/D_w > 0.002$) the error in Equation (7) can be quite large.

The contact angle α_R is independent of the radial

clearance; however, the initial contact angle α_o varies with the radial clearance when the inner or outer ring is displaced axially. This relationship is given by Equation (2).

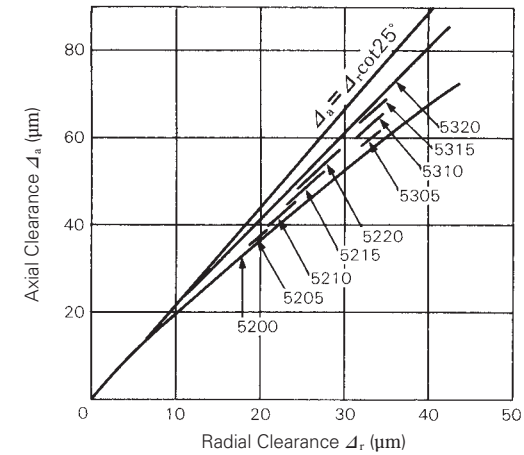

Fig. 2 Radial and Axial Clearances of Series 52 and 53 Bearings

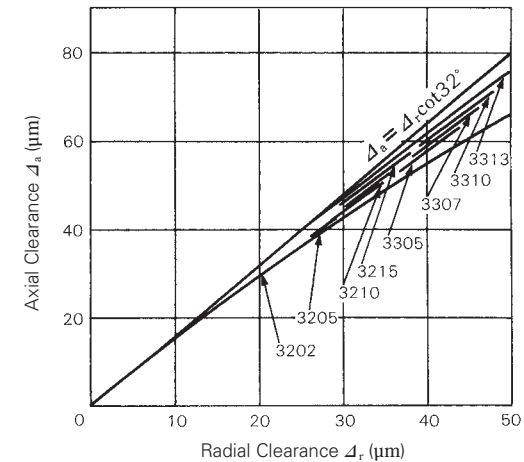
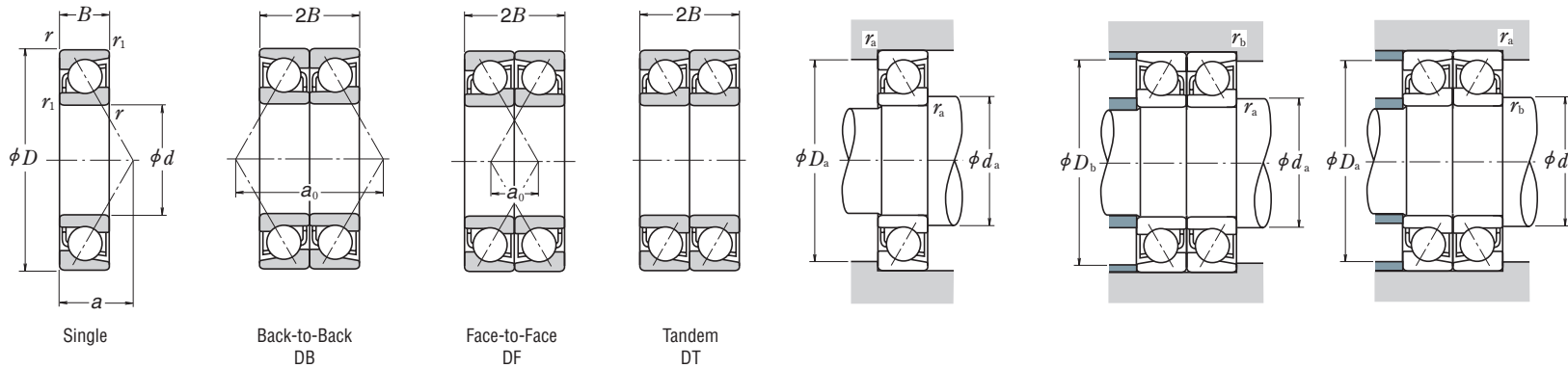

Fig. 3 Radial and Axial Clearances of Series 32 and 33 Bearings

■ ANGULAR CONTACT BALL BEARINGS

SINGLE/MATCHED MOUNTINGS
Bore Diameter 10 – 15 mm



Dynamic Equivalent Load $P = XF_r + YF_a$

Contact Angle	$\frac{if_0F_a^*}{C_{or}}$	e	Single, DT				DB or DF			
			$F_a/F_r \le e$		$F_a/F_r > e$		$F_a/F_r \le e$		$F_a/F_r > e$	
			X	Y	X	Y	X	Y	X	Y
15°	0.178	0.38	1	0	0.44	1.47	1	1.65	0.72	2.39
	0.357	0.40	1	0	0.44	1.40	1	1.57	0.72	2.28
	0.714	0.43	1	0	0.44	1.30	1	1.46	0.72	2.11
	1.07	0.46	1	0	0.44	1.23	1	1.38	0.72	2.00
	1.43	0.47	1	0	0.44	1.19	1	1.34	0.72	1.93
	2.14	0.50	1	0	0.44	1.12	1	1.26	0.72	1.82
25°	3.57	0.55	1	0	0.44	1.02	1	1.14	0.72	1.66
	5.35	0.56	1	0	0.44	1.00	1	1.12	0.72	1.63
	—	0.68	1	0	0.41	0.87	1	0.92	0.67	1.41
	—	0.80	1	0	0.39	0.76	1	0.78	0.63	1.24
30°	—	1.14	1	0	0.35	0.57	1	0.55	0.57	0.93

*For i, use 2 for DB and DF and 1 for DT

Static Equivalent Load $P_0 = X_0F_r + Y_0F_a$

Contact Angle	Single, DT		DB or DF		Single or DT mounting when $F_r > 0.5F_a + Y_0F_a$ use $P_0 = F_r$
	X ₀	Y ₀	X ₀	Y ₀	
15°	0.5	0.46	1	0.92	
25°	0.5	0.38	1	0.76	
30°	0.5	0.33	1	0.66	
40°	0.5	0.26	1	0.52	

Boundary Dimensions (mm)					Basic Load Ratings (Single) (N)		Factor f_0	Limiting Speeds (1) (min ⁻¹)		Eff. Load Center (mm) a	Abutment and Fillet Dimensions (mm)			Mass (kg) approx.	Bearing Designations (2)				Basic Load Ratings (Matched) (N)		Limiting Speeds (1) (Matched) (min ⁻¹)		Load Center Spacings (mm)		Abutment and Fillet Dimensions (mm)		
d	D	B	r min.	r ₁ min.	C _r	C _{0r}		Grease	Oil		d _a min.	D _a max.	r _a max.		Single	Standard	Option	Arrangement	C _r	C _{0r}	Grease	Oil	DB	DF	a ₀	DF	d _b (3) min.
10	22	6	0.3	0.15	2 880	1 450	—	40 000	56 000	6.7	12.5	19.5	0.3	0.010	7900 A5	TYN (M)	DB DF DT	4 700	2 900	32 000	43 000	13.5	1.5	—	20.8	0.15	
	22	6	0.3	0.15	3 000	1 520	14.1	48 000	63 000	5.1	12.5	19.5	0.3	0.010	7900 C	TYN (M),T	DB DF DT	4 900	3 050	38 000	53 000	10.3	1.7	—	20.8	0.15	
	26	8	0.3	0.15	5 350	2 600	—	24 000	34 000	9.2	12.5	23.5	0.3	0.019	7000 A	W (M), T, TYN	DB DF DT	8 750	5 200	20 000	28 000	18.4	2.4	11.2	24.8	0.15	
	26	8	0.3	0.15	5 300	2 490	12.6	45 000	63 000	6.4	12.5	23.5	0.3	0.019	7000 C	TYN W,(M),T	DB DF DT	8 650	5 000	36 000	50 000	12.8	3.2	—	24.8	0.15	
	30	9	0.6	0.3	5 400	2 710	—	22 000	30 000	10.3	15	25	0.6	0.032	7200 A	W (M), TYN	DB DF DT	8 800	5 400	18 000	24 000	20.5	2.5	12.5	27.5	0.3	
	30	9	0.6	0.3	5 000	2 500	—	16 000	22 000	12.9	15	25	0.6	0.032	7200 B	W (M), T	DB DF DT	8 100	5 000	13 000	18 000	25.8	7.8	12.5	27.5	0.3	
	30	9	0.6	0.3	5 400	2 610	13.2	40 000	56 000	7.2	15	25	0.6	0.032	7200 C	TYN W,(M),T	DB DF DT	8 800	5 200	32 000	45 000	14.4	3.6	—	27.5	0.3	
	35	11	0.6	0.3	9 300	4 300	—	16 000	22 000	12.0	15	30	0.6	0.053	7300 A	W (M), T	DB DF DT	15 100	8 600	13 000	17 000	24.0	2.0	12.5	32.5	0.3	
	35	11	0.6	0.3	8 750	4 050	—	14 000	20 000	14.9	15	30	0.6	0.054	7300 B	W (M), T	DB DF DT	14 200	8 100	11 000	16 000	29.9	7.9	12.5	32.5	0.3	
	12	24	6	0.3	0.15	3 200	1 770	—	38 000	53 000	7.2	14.5	21.5	0.3	0.011	7901 A5	TYN (M),T	DB DF DT	5 200	3 550	30 000	43 000	14.4	2.4	—	22.8	0.15
24		6	0.3	0.15	3 350	1 860	14.7	45 000	63 000	5.4	14.5	21.5	0.3	0.011	7901 C	TYN (M),T	DB DF DT	5 450	3 700	36 000	50 000	10.8	1.2	—	22.8	0.15	
28		8	0.3	0.15	5 800	2 980	—	22 000	30 000	9.8	14.5	25.5	0.3	0.021	7001 A	W (M), T, TYN	DB DF DT	9 400	5 950	18 000	24 000	19.5	3.5	13.2	26.8	0.15	
28		8	0.3	0.15	5 800	2 900	13.2	40 000	56 000	6.7	14.5	25.5	0.3	0.021	7001 C	TYN W,(M),T	DB DF DT	9 400	5 800	32 000	45 000	13.4	2.6	—	26.8	0.15	
32		10	0.6	0.3	8 000	4 050	—	20 000	28 000	11.4	17	27	0.6	0.037	7201 A	W (M), T, TYN	DB DF DT	13 000	8 050	16 000	22 000	22.7	2.7	14.5	29.5	0.3	
32		10	0.6	0.3	7 450	3 750	—	15 000	20 000	14.2	17	27	0.6	0.038	7201 B	W (M), T	DB DF DT	12 100	7 500	12 000	16 000	28.5	8.5	14.5	29.5	0.3	
32		10	0.6	0.3	8 150	3 750	—	20 000	30 000	14.2	17	27	0.6	0.036	*7201 BEA	T85	—	—	16 000	24 000	28.5	8.5	14.5	29.5	0.3		
32		10	0.6	0.3	7 900	3 850	12.5	36 000	50 000	7.9	17	27	0.6	0.036	7201 C	TYN W,(M),T	DB DF DT	12 800	7 700	30 000	40 000	15.9	4.1	—	29.5	0.3	
37		12	1	0.6	9 450	4 500	—	15 000	20 000	13.1	18	31	1	0.060	7301 A	W (M), T	DB DF DT	15 400	9 000	12 000	16 000	26.1	2.1	17	32	0.6	
37		12	1	0.6	8 850	4 200	—	13 000	18 000	16.3	18	31	1	0.062	7301 B	W (M), T	DB DF DT	14 400	8 400	10 000	14 000	32.6	8.6	17	32	0.6	
37	12	1	0.6	11 100	4 950	—	18 000	26 000	16.3	18	31	1	0.061	*7301 BEA	T85	—	—	15 000	22 000	32.6	8.6	17	32	0.6			
15	28	7	0.3	0.15	4 550	2 530	—	32 000	43 000	8.5	17.5	25.5	0.3	0.016	7902 A5	TYN (M),T	DB DF DT	7 400	5 050	26 000	34 000	17.0	3.0	—	26.8	0.15	
	28	7	0.3	0.15	4 750	2 640	14.5	38 000	53 000	6.4	17.5	25.5	0.3	0.016	7902 C	TYN (M),T	DB DF DT	7 750	5 300	30 000	43 000	12.8	1.2	—	26.8	0.15	
	32	9	0.3	0.15	6 100	3 450	—	19 000	26 000	11.3	17.5	29.5	0.3	0.030	7002 A	W (M), T, TYN	DB DF DT	9 950	6 850	15 000	22 000	22.6	4.6	16.2	30.8	0.15	
	32	9	0.3	0.15	6 250	3 400	14.1	34 000	48 000	7.6	17.5	29.5	0.3	0.030	7002 C	TYN W,(M),T	DB DF DT	10 100	6 750	28 000	38 000	15.3	2.7	—	30.8	0.15	
	35	11	0.6	0.3	8 650	4 650	—	18 000	24 000	12.7	20	30	0.6	0.045	7202 A	W (M), T, TYN	DB DF DT	14 000	9 300	14 000	20 000	25.4	3.4	17.5	32.5	0.3	
	35	11	0.6	0.3	7 950	4 300	—	13 000	18 000	16.0	20	30	0.6	0.046	7202 B	W (M), T	DB DF DT	12 900	8 600	10 000	14 000	32.0	10.0	17.5	32.5	0.3	
	35	11	0.6	0.3	9 800	4 800	—	18 000	26 000	16.0	20	30	0.6	0.044	*7202 BEA	T85	—	—	14 000	20 000	32.0	10.0	17.5	32.5	0.3		
	35	11	0.6	0.3	8 650	4 550	13.2	32 000	45 000	8.8	20	30	0.6	0.045	7202 C	TYN W,(M),T	DB DF DT	14 100	9 050	26 000	36 000	17.7	4.3	—	32.5	0.3	
	42	13	1	0.6	13 400	7 100	—	13 000	17 000	14.7	21	36	1	0.084	7302 A	W (M), T	DB DF DT	21 800	14 200	10 000	13 000	29.5	3.5	20	37	0.6	
	42	13	1	0.6	12 500	6 600	—	11 000	15 000	18.5	21	36	1	0.086	7302 B	W (M), T	DB DF DT	20 200	13 200	9 000	12 000	36.9	10.9	20	37	0.6	
42	13	1	0.6	14 300	6 900	—	16 000	22 000	18.5	21	36	1	0.084	*7302 BEA	T85	—	—	13 000	18 000	36.9	10.9	20	37	0.6			

Notes (1) For applications operating near the limiting speed, refer to Page C077.
 (2) Suffixes A, A5, B, and C represent contact angles of 30°, 25°, 40°, and 15° respectively.
 (3) Use the values of d_a (min) and r_a (max) for bearings with “—” in the d_a column.

Note (4) Cage designation (M) is usually omitted from the bearing designation.
 Remark Bearings with an asterisk (*) are NSKHPS angular contact ball bearings. In arrangements, they are limited to SU universal matching types. See Page C073 for details.

ANGULAR CONTACT BALL BEARINGS

SINGLE/MATCHED MOUNTINGS

Bore Diameter 17 – 25 mm

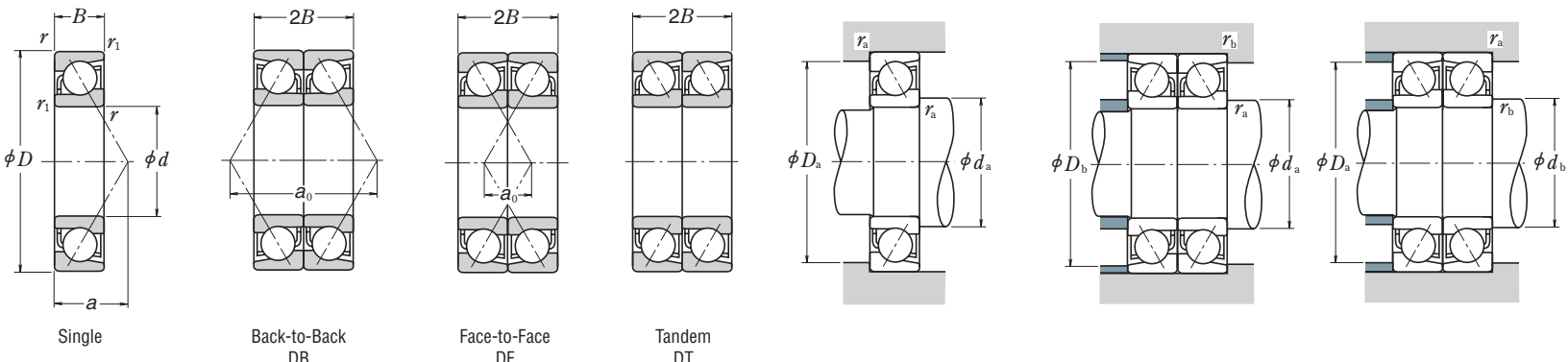

Dynamic Equivalent Load $P = X F_r + Y F_a$

Contact Angle	$i f_a F_a / C_{or}$	e	Single, DT				DB or DF			
			$F_a/F_r \leq e$		$F_a/F_r > e$		$F_a/F_r \leq e$		$F_a/F_r > e$	
			X	Y	X	Y	X	Y	X	Y
15°	0.178	0.38	1	0	0.44	1.47	1	1.65	0.72	2.39
	0.357	0.40	1	0	0.44	1.40	1	1.57	0.72	2.28
	0.714	0.43	1	0	0.44	1.30	1	1.46	0.72	2.11
	1.07	0.46	1	0	0.44	1.23	1	1.38	0.72	2.00
	1.43	0.47	1	0	0.44	1.19	1	1.34	0.72	1.93
	2.14	0.50	1	0	0.44	1.12	1	1.26	0.72	1.82
25°	3.57	0.55	1	0	0.44	1.02	1	1.14	0.72	1.66
	5.35	0.56	1	0	0.44	1.00	1	1.12	0.72	1.63
	0.68	0.80	1	0	0.41	0.87	1	0.92	0.67	1.41
	0.80	1	0	0.39	0.76	1	0.78	0.63	1.24	
	1.14	1	0	0.35	0.57	1	0.55	0.57	0.93	

*For i, use 2 for DB and DF and 1 for DT

Static Equivalent Load $P_0 = X_0 F_r + Y_0 F_a$

Contact Angle	Single, DT		DB or DF		Single or DT mounting When $F_r > 0.5 F_r + Y_0 F_a$ use $P_0 = F_r$
	X_0	Y_0	X_0	Y_0	
15°	0.5	0.46	1	0.92	
25°	0.5	0.38	1	0.76	
30°	0.5	0.33	1	0.66	
40°	0.5	0.26	1	0.52	

Boundary Dimensions (mm)	Basic Load Ratings (Single)		Factor	Limiting Speeds (1)		Eff. Load Center (mm)	Abutment and Fillet Dimensions (mm)			Mass (kg)	Bearing Designations (2)				Basic Load Ratings (Matched)		Limiting Speeds (1) (Matched)		Load Center Spacings (mm)		Abutment and Fillet Dimensions (mm)								
	d	D		B	r min.		r1 min.	C _r	C _{0r}		f ₀	Grease	Oil	a	d _a min.	D _a max.	r _a max.	Single	Standard	Option	Arrangement	C _r	C _{0r}	Grease	Oil	DB	DF	a ₀	DF
17	30	7	0.3	0.15	4 750	2 800	—	30 000	40 000	9.0	19.5	27.5	0.3	0.017	7903 A5	TYN	(M), T	DB DF DT	7 750	5 600	24 000	32 000	18.0	4.0	—	—	28.8	0.15	
	30	7	0.3	0.15	5 000	2 940	14.8	34 000	48 000	6.6	19.5	27.5	0.3	0.017	7903 C	TYN	(M), T	DB DF DT	8 150	5 850	28 000	38 000	13.3	0.7	—	—	28.8	0.15	
	35	10	0.3	0.15	6 400	3 800	—	17 000	24 000	12.5	19.5	32.5	0.3	0.040	7003 A	W	(M), T, TYN	DB DF DT	10 400	7 650	14 000	19 000	25.0	5.0	18.2	33.8	0.15		
	35	10	0.3	0.15	6 600	3 800	14.5	32 000	43 000	8.5	19.5	32.5	0.3	0.040	7003 C	TYN	(M), T	DB DF DT	10 700	7 600	26 000	34 000	17.0	3.0	—	—	33.8	0.15	
	40	12	0.6	0.3	10 800	6 000	—	16 000	22 000	14.2	22	35	0.6	0.067	7203 A	W	(M), T, TYN	DB DF DT	17 600	12 000	13 000	17 000	28.5	4.5	19.5	37.5	0.3		
	40	12	0.6	0.3	9 950	5 500	—	11 000	15 000	18.0	22	35	0.6	0.068	7203 B	W	(M), T	DB DF DT	16 100	11 000	9 000	12 000	35.9	11.9	19.5	37.5	0.3		
	40	12	0.6	0.3	11 600	6 100	—	16 000	22 000	18.2	22	35	0.6	0.065	*7203 BEA	T85	T7	—	—	—	—	13 000	18 000	36.3	12.3	19.5	37.5	0.3	
	40	12	0.6	0.3	10 900	5 850	13.3	28 000	38 000	9.8	22	35	0.6	0.065	7203 C	TYN	W, (M), T	DB DF DT	17 600	11 700	22 000	32 000	19.6	4.4	—	—	37.5	0.3	
	47	14	1	0.6	15 900	8 650	—	11 000	15 000	16.2	23	41	1	0.116	7303 A	W	(M), T	DB DF DT	25 900	17 300	9 000	12 000	32.5	4.5	22	42	0.6		
	47	14	1	0.6	14 800	8 000	—	10 000	14 000	20.4	23	41	1	0.118	7303 B	W	(M), T	DB DF DT	24 000	16 000	8 000	11 000	40.9	12.9	22	42	0.6		
	47	14	1	0.6	16 800	8 300	—	14 000	20 000	20.4	23	41	1	0.113	*7303 BEA	T85	—	—	—	—	11 000	16 000	40.9	12.9	22	42	0.6		
	20	37	9	0.3	0.15	6 600	4 050	—	24 000	32 000	11.1	22.5	34.5	0.3	0.037	7904 A5	TYN	(M), T	DB DF DT	10 700	8 100	19 000	26 000	22.3	4.3	—	—	35.8	0.15
		37	9	0.3	0.15	6 950	4 250	14.9	28 000	38 000	8.3	22.5	34.5	0.3	0.036	7904 C	TYN	(M), T	DB DF DT	11 300	8 500	22 000	32 000	16.6	1.4	—	—	35.8	0.15
		42	12	0.6	0.3	10 800	6 600	—	14 000	20 000	14.9	25	37	0.6	0.068	7004 A	W	(M), T, TYN	DB DF DT	17 600	13 200	12 000	16 000	29.9	5.9	22.5	39.5	0.3	
42		12	0.6	0.3	11 100	6 550	14.0	26 000	36 000	10.1	25	37	0.6	0.068	7004 C	TYN	W, (M), T	DB DF DT	18 000	13 100	20 000	30 000	20.3	3.7	—	—	39.5	0.3	
47		14	1	0.6	14 500	8 300	—	13 000	18 000	16.7	26	41	1	0.106	7204 A	W	(M), T, TYN	DB DF DT	23 500	16 600	11 000	15 000	33.3	5.3	25	42	0.6		
47		14	1	0.6	13 300	7 650	—	9 500	13 000	21.1	26	41	1	0.109	7204 B	W	(M), T	DB DF DT	21 600	15 300	7 500	11 000	42.1	14.1	25	42	0.6		
47		14	1	0.6	15 600	8 150	—	13 000	19 000	21.1	26	41	1	0.103	*7204 BEA	T85	T7	—	—	—	—	11 000	16 000	42.1	14.1	25	42	0.6	
47		14	1	0.6	14 600	8 050	13.3	24 000	34 000	11.5	26	41	1	0.104	7204 C	TYN	W, (M), T	DB DF DT	23 600	16 100	19 000	26 000	23.0	5.0	—	—	42	0.6	
52		15	1.1	0.6	18 700	10 400	—	10 000	13 000	17.9	27	45	1	0.146	7304 A	W	(M), T	DB DF DT	30 500	20 800	8 000	11 000	35.8	5.8	25	47	0.6		
52		15	1.1	0.6	17 300	9 650	—	9 000	12 000	22.6	27	45	1	0.150	7304 B	W	(M), T	DB DF DT	28 200	19 300	7 100	10 000	45.2	15.2	25	47	0.6		
52		15	1.1	0.6	19 800	10 500	—	13 000	18 000	22.6	27	45	1	0.149	*7304 BEA	T85	MR, T7	—	—	—	—	10 000	14 000	45.2	15.2	25	47	0.6	
25		42	9	0.3	0.15	7 450	5 150	—	20 000	28 000	12.3	27.5	39.5	0.3	0.043	7905 A5	TYN	(M), T	DB DF DT	12 100	10 300	16 000	22 000	24.6	6.6	—	—	40.8	0.15
		42	9	0.3	0.15	7 850	5 400	15.5	24 000	34 000	9.0	27.5	39.5	0.3	0.043	7905 C	TYN	(M), T	DB DF DT	12 700	10 800	19 000	26 000	18.0	0.0	—	—	40.8	0.15
		47	12	0.6	0.3	11 300	7 400	—	12 000	17 000	16.4	30	42	0.6	0.079	7005 A	W	(M), T, TYN	DB DF DT	18 300	14 800	10 000	14 000	32.8	8.8	27.5	44.5	0.3	
	47	12	0.6	0.3	11 700	7 400	14.7	22 000	30 000	10.8	30	42	0.6	0.078	7005 C	TYN	W, (M), T	DB DF DT	19 000	14 800	18 000	26 000	21.6	2.4	—	—	44.5	0.3	
	52	15	1	0.6	16 200	10 300	—	12 000	16 000	18.6	31	46	1	0.130	7205 A	W	(M), T, TYN	DB DF DT	26 300	20 500	9 500	13 000	37.2	7.2	30	47	0.6		
	52	15	1	0.6	14 800	9 400	—	8 500	11 000	23.7	31	46	1	0.133	7205 B	W	(M), T	DB DF DT	24 000	18 800	6 700	9 000	47.3	17.3	30	47	0.6		
	52	15	1	0.6	17 600	10 200	—	12 000	17 000	23.7	31	46	1	0.127	*7205 BEA	T85	T7	—	—	—	—	9 500	14 000	47.3	17.3	30	47	0.6	
	52	15	1	0.6	16 600	10 200	14.0	22 000	28 000	12.7	31	46	1	0.129	7205 C	TYN	W, (M), T	DB DF DT	27 000	20 400	17 000	24 000	25.3	4.7	—	—	47	0.6	
	62	17	1.1	0.6	26 400	15 800	—	8 500	11 000	21.1	32	55	1	0.235	7305 A	W	(M), T	DB DF DT	43 000	31 500	6 700	9 000	42.1	8.1	30	57	0.6		

Notes (1) For applications operating near the limiting speed, refer to Page C077.
 (2) Suffixes A, A5, B, and C represent contact angles of 30°, 25°, 40°, and 15° respectively.
 (3) Use the values of d_a (min) and r_a (max) for bearings with “—” in the d_a column.

Note (4) Cage designation (M) is usually omitted from the bearing designation.
Remark Bearings with an asterisk (*) are NSKHPS angular contact ball bearings. In arrangements, they are limited to SU universal matching types. See Page C073 for details.

ANGULAR CONTACT BALL BEARINGS

SINGLE/MATCHED MOUNTINGS

Bore Diameter 55 – 65 mm

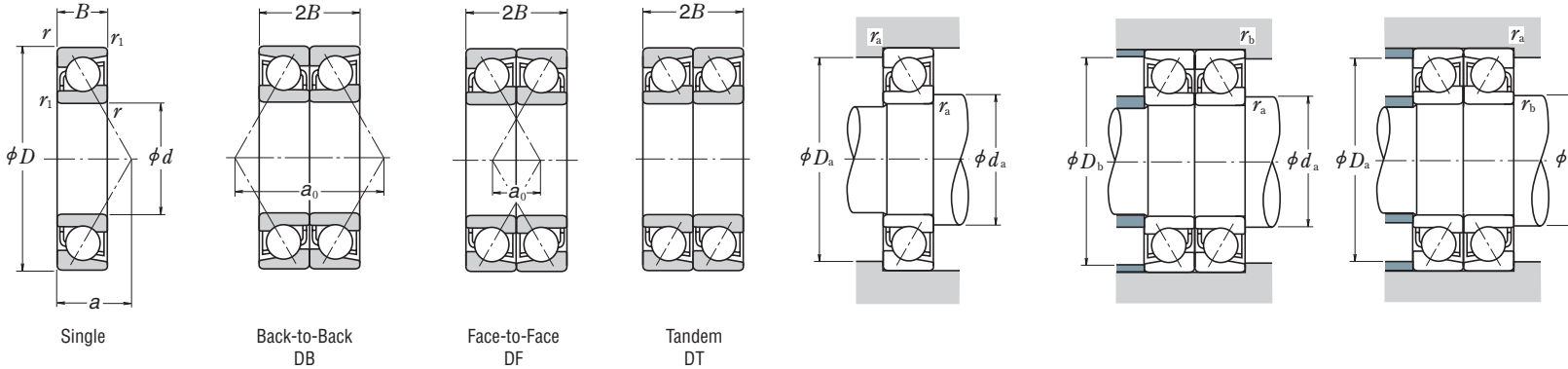

Dynamic Equivalent Load $P = XF_r + YF_a$

Contact Angle	$i/f_a \cdot C_{or}^*$	e	Single, DT							
			$F_a/F_r \leq e$				$F_a/F_r > e$			
			X	Y	X	Y	X	Y	X	Y
15°	0.178 0.357 0.714 1.07 1.43 2.14 3.57 5.35	0.38 0.40 0.43 0.46 0.47 0.50 0.55 0.56	1 0 0 0 0 0 0 0	0 0.44 1.40 1.47 1.30 1.23 1.19 1.12	1 1 1 1 1 1 1 1	1.65 1.57 1.46 1.38 1.34 1.26 1.14 1.12	0.72 0.72 0.72 0.72 0.72 0.72 0.72 0.72	2.39 2.28 2.11 2.00 1.93 1.82 1.66 1.63		
25°	—	0.68	1	0	0.41	0.87	1	0.92	0.67	1.41
30°	—	0.80	1	0	0.39	0.76	1	0.78	0.63	1.24
40°	—	1.14	1	0	0.35	0.57	1	0.55	0.57	0.93

*For i, use 2 for DB and DF and 1 for DT

Static Equivalent Load $P_0 = X_0 F_r + Y_0 F_a$

Contact Angle	Single, DT				Single or DT mounting When $F_r > 0.5 F_r + Y_0 F_a$ use $P_0 = F_r$
	X ₀	Y ₀	X ₀	Y ₀	
15°	0.5	0.46	1	0.92	
25°	0.5	0.38	1	0.76	
30°	0.5	0.33	1	0.66	
40°	0.5	0.26	1	0.52	

Boundary Dimensions (mm)					Basic Load Ratings (Single)		Factor	Limiting Speeds (1)		Eff. Load Center (mm) a	Abutment and Fillet Dimensions (mm)			Mass (kg) approx.	Bearing Designations (2)				Basic Load Ratings (Matched)		Limiting Speeds (1) (Matched)		Load Center Spacings (mm)		Abutment and Fillet Dimensions (mm)		
d	D	B	$r_{min.}$	$r_{1min.}$	C_r	C_{0r}		Grease	Oil		d_a min.	D_a max.	r_a max.		Single	Standard	Option	Arrangement	C_r	C_{0r}	Grease	Oil	DB a_0	DF	d_b (3) min.	D_b max.	r_b (3) max.
55	90	18	1.1	0.6	34 000	28 600	15.5	11 000	15 000	18.7	62	83	1	0.430	7011 C (M) W, T, TYN	DB DF DT	55 500	57 500	9 000	12 000	37.4	1.4	—	85	0.6		
	100	21	1.5	1	51 000	39 500	—	5 600	8 000	32.9	64	91	1.5	0.613	7211 A W (M), T, TYN	DB DF DT	83 000	79 000	4 500	6 300	65.7	23.7	61	94	1		
	100	21	1.5	1	46 500	36 000	—	4 000	5 600	43.0	64	91	1.5	0.627	7211 B W (M), T	DB DF DT	75 000	72 000	3 400	4 500	86.0	44.0	61	94	1		
	100	21	1.5	1	51 500	37 000	—	6 000	8 500	43.0	64	91	1.5	0.596	*7211 BEA T85 MR, T7	—	—	—	—	4 500	6 700	86.0	44.0	61	94	1	
	100	21	1.5	1	53 000	40 000	14.5	10 000	14 000	20.9	64	91	1.5	0.688	7211 C (M) W, T, TYN	DB DF DT	86 000	80 000	8 500	12 000	41.7	0.3	—	94	1		
	120	29	2	1	86 000	61 500	—	4 000	5 600	39.8	65	110	2	1.41	7311 A W (M), T	DB DF DT	139 000	123 000	3 200	4 300	79.5	21.5	61	114	1		
	120	29	2	1	89 000	58 500	—	5 000	7 500	51.2	65	110	2	1.36	*7311 BEA T85 MR, T7	—	—	—	—	4 000	6 000	102.4	44.4	61	114	1	
	120	29	2	1	89 000	58 500	—	3 600	5 000	51.2	65	110	2	1.42	7311 BEA W	DB DF DT	145 000	117 000	3 000	4 000	102.4	44.4	61	114	1		
60	85	13	1	0.6	18 300	17 700	—	9 500	13 000	23.4	66	79	1	0.197	7912 A5 (M) T, TYN	DB DF DT	29 800	35 500	7 500	10 000	46.8	20.8	—	80	0.6		
	85	13	1	0.6	19 400	18 700	16.5	11 000	15 000	16.2	66	79	1	0.194	7912 C (M) T, TYN	DB DF DT	31 500	37 500	9 000	12 000	32.4	6.4	—	80	0.6		
	95	18	1.1	0.6	33 000	29 500	—	5 600	8 000	31.4	67	88	1	0.417	7012 A W (M), T, TYN	DB DF DT	53 500	59 000	4 500	6 300	62.7	26.7	65	90	0.6		
	95	18	1.1	0.6	35 000	30 500	15.7	10 000	14 000	19.4	67	88	1	0.460	7012 C (M) W, T, TYN	DB DF DT	57 000	61 500	8 500	12 000	38.8	2.8	—	90	0.6		
	110	22	1.5	1	62 000	48 500	—	5 300	7 100	35.5	69	101	1.5	0.798	7212 A W (M), T, TYN	DB DF DT	100 000	97 500	4 300	6 000	71.1	27.1	66	104	1		
	110	22	1.5	1	56 000	44 500	—	3 800	5 300	46.7	69	101	1.5	0.815	7212 B W (M), T	DB DF DT	91 000	89 000	3 000	4 000	93.3	49.3	66	104	1		
	110	22	1.5	1	61 500	45 000	—	5 300	7 500	46.7	69	101	1.5	0.791	*7212 BEA T85 MR, T7	—	—	—	—	4 300	6 000	93.3	49.3	66	104	1	
	110	22	1.5	1	64 000	49 000	14.4	9 500	13 000	22.4	69	101	1.5	0.889	7212 C (M) W, T, TYN	DB DF DT	104 000	98 500	7 500	11 000	44.8	0.8	—	104	1		
130	31	2.1	1.1	98 000	71 500	—	3 800	5 000	42.9	72	118	2	1.74	7312 A W (M), T	DB DF DT	159 000	143 000	3 000	4 000	85.9	23.9	67	123	1			
65	130	31	2.1	1.1	102 000	68 500	—	4 800	6 700	55.4	72	118	2	1.70	*7312 BEA T85 MR, T7	—	—	—	—	3 800	5 600	110.7	48.7	67	123	1	
	130	31	2.1	1.1	102 000	68 500	—	3 400	4 500	55.4	72	118	2	1.77	7312 BEA W	DB DF DT	166 000	137 000	2 600	3 800	110.7	48.7	67	123	1		
	90	13	1	0.6	19 100	19 400	—	9 000	12 000	24.6	71	84	1	0.211	7913 A5 (M) T, TYN	DB DF DT	31 000	39 000	7 100	9 500	49.1	23.1	—	85	0.6		
	90	13	1	0.6	20 200	20 500	16.7	10 000	14 000	16.9	71	84	1	0.208	7913 C (M) T, TYN	DB DF DT	33 000	41 000	8 500	12 000	33.8	7.8	—	85	0.6		
	100	18	1.1	0.6	35 000	33 000	—	5 300	7 500	32.8	72	93	1	0.455	7013 A W (M), T, TYN	DB DF DT	56 500	65 500	4 300	6 000	65.6	29.6	70	95	0.6		
	100	18	1.1	0.6	37 000	34 500	15.9	10 000	13 000	20.0	72	93	1	0.493	7013 C (M) W, T, TYN	DB DF DT	60 500	68 500	8 000	11 000	40.1	4.1	—	95	0.6		
	120	23	1.5	1	70 500	58 000	—	4 800	6 700	38.2	74	111	1.5	1.03	7213 A W (M), T, TYN	DB DF DT	114 000	116 000	3 800	5 300	76.4	30.4	71	114	1		
	120	23	1.5	1	63 500	52 500	—	3 400	4 800	50.3	74	111	1.5	1.05	7213 B W (M), T	DB DF DT	103 000	105 000	2 800	3 800	100.6	54.6	71	114	1		
120	23	1.5	1	70 000	53 500	—	4 800	7 100	50.3	74	111	1.5	1.01	*7213 BEA T85 MR, T7	—	—	—	—	3 800	5 600	100.6	54.6	71	114	1		
120	23	1.5	1	73 000	58 500	14.6	9 000	12 000	23.9	74	111	1.5	1.14	7213 C (M) W, T, TYN	DB DF DT	119 000	117 000	7 100	9 500	47.8	1.8	—	114	1			
140	33	2.1	1.1	111 000	82 000	—	3 600	4 800	46.1	77	128	2	2.12	7313 A W (M), T	DB DF DT	180 000	164 000	2 800	3 800	92.2	26.2	72	133	1			
140	33	2.1	1.1	114 000	77 000	—	4 300	6 300	59.5	77	128	2	2.09	*7313 BEA T85 MR, T7	—	—	—	—	3 600	5 000	119.0	53.0	72	133	1		
140	33	2.1	1.1	114 000	77 000	—	3 200	4 300	59.5	77	128	2	2.17	7313 BEA W	DB DF DT	184 000	154 000	2 400	3 400	119.0	53.0	72	133	1			

Notes (1) For applications operating near the limiting speed, refer to Page C077.
 (2) Suffixes A, A5, B, and C represent contact angles of 30°, 25°, 40°, and 15° respectively.
 (3) Use the values of d_a (min) and r_a (max) for bearings with "—" in the d_a column.

Note (4) Cage designation (M) is usually omitted from the bearing designation.
Remark Bearings with an asterisk (*) are NSKHPS angular contact ball bearings. In arrangements, they are limited to SU universal matching types. See Page C073 for details.

ANGULAR CONTACT BALL BEARINGS

SINGLE/MATCHED MOUNTINGS

Bore Diameter 70 – 80 mm

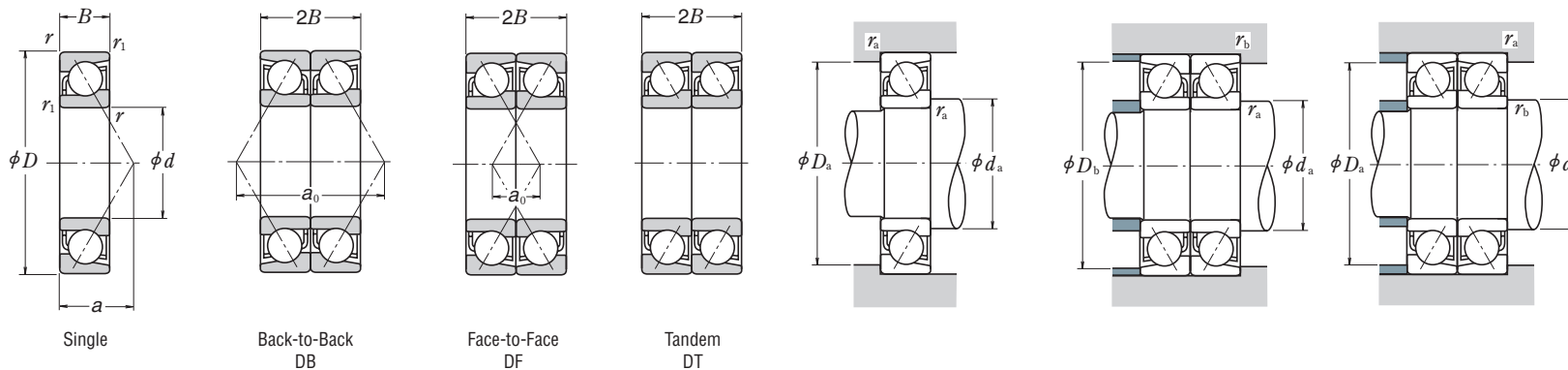

Dynamic Equivalent Load $P = XF_r + YF_a$

Contact Angle	$i f_0 F_a^*$ C_{0r}	e	Single, DT				DB or DF			
			$F_a/F_r \leq e$		$F_a/F_r > e$		$F_a/F_r \leq e$		$F_a/F_r > e$	
			X	Y	X	Y	X	Y	X	Y
15°	0.178	0.38	1	0	0.44	1.47	1	1.65	0.72	2.39
	0.357	0.40	1	0	0.44	1.40	1	1.57	0.72	2.28
	0.714	0.43	1	0	0.44	1.30	1	1.46	0.72	2.11
	1.07	0.46	1	0	0.44	1.23	1	1.38	0.72	2.00
	1.43	0.47	1	0	0.44	1.19	1	1.34	0.72	1.93
	2.14	0.50	1	0	0.44	1.12	1	1.26	0.72	1.82
	3.57	0.55	1	0	0.44	1.02	1	1.14	0.72	1.66
	5.35	0.56	1	0	0.44	1.00	1	1.12	0.72	1.63
	25°	—	0.68	1	0	0.41	0.87	1	0.92	0.67
30°	—	0.80	1	0	0.39	0.76	1	0.78	0.63	1.24
40°	—	1.14	1	0	0.35	0.57	1	0.55	0.57	0.93

*For i , use 2 for DB and DF and 1 for DT

Static Equivalent Load $P_0 = X_0 F_r + Y_0 F_a$

Contact Angle	Single, DT		DB or DF		Single or DT mounting When $F_r > 0.5 F_r + Y_0 F_a$ use $P_0 = F_r$
	X_0	Y_0	X_0	Y_0	
15°	0.5	0.46	1	0.92	
25°	0.5	0.38	1	0.76	
30°	0.5	0.33	1	0.66	
40°	0.5	0.26	1	0.52	

d	Boundary Dimensions (mm)					Basic Load Ratings (Single)		Factor f_0	Limiting Speeds (1) (min ⁻¹)		Eff. Load Center (mm) a	Abutment and Fillet Dimensions (mm)			Mass (kg) approx.	Bearing Designations (2)				Basic Load Ratings (Matched)		Limiting Speeds (1) (Matched)		Load Center Spacings (mm)		Abutment and Fillet Dimensions (mm)		
	D	B	r min.	r ₁ min.	C _r	C _{0r}	Grease		Oil	d _a min.		D _a max.	r _a max.	Single		Standard	Option	Arrangement	C _r	C _{0r}	Grease	Oil	DB	DF	d _b (3) min.	D _b max.	r _b (3) max.	
	70	100	16	1	0.6	26 500	26 300		—	8 000		11 000	27.8	76		94	1	0.341	7914 A5 (M) T, TYN	DB DF DT	43 000	52 500	6 300	9 000	55.6	23.6	—	95

Notes (1) For applications operating near the limiting speed, refer to Page C077.
 (2) Suffixes A, A5, B, and C represent contact angles of 30°, 25°, 40°, and 15° respectively.
 (3) Use the values of d_a (min) and r_a (max) for bearings with "—" in the d_b column.

Note (4) Cage designation (M) is usually omitted from the bearing designation.
Remark Bearings with an asterisk (*) are NSKHPS angular contact ball bearings. In arrangements, they are limited to SU universal matching types. See Page C073 for details.

ANGULAR CONTACT BALL BEARINGS

SINGLE/MATCHED MOUNTINGS

Bore Diameter 85 – 100 mm

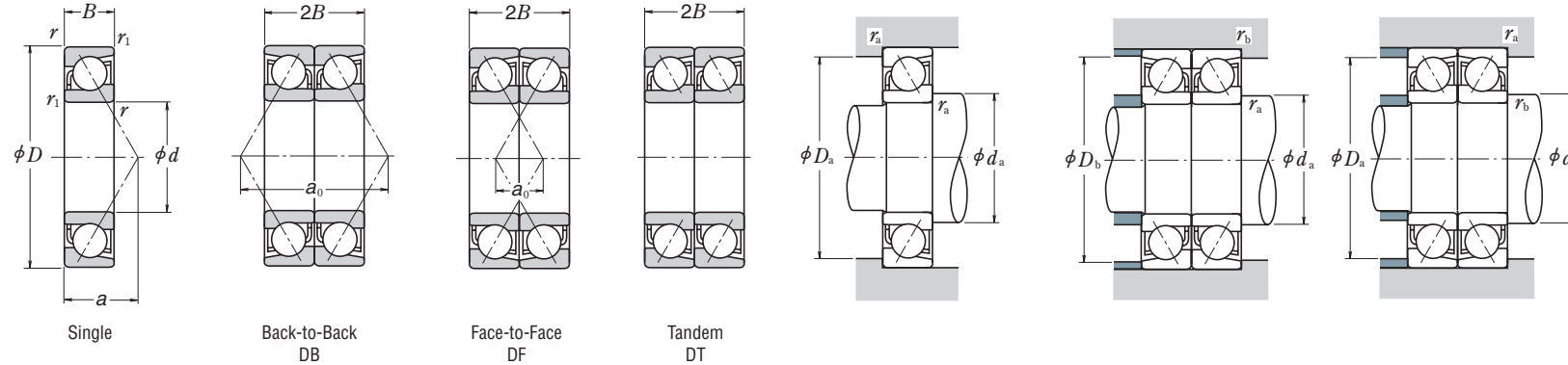

Dynamic Equivalent Load $P = X F_r + Y F_a$

Contact Angle	$i f_0 F_a^* / C_{0r}$	e	Single, DT				DB or DF			
			$F_a/F_r \leq e$		$F_a/F_r > e$		$F_a/F_r \leq e$		$F_a/F_r > e$	
			X	Y	X	Y	X	Y	X	Y
15°	0.178	0.38	1	0	0.44	1.47	1	1.65	0.72	2.39
	0.357	0.40	1	0	0.44	1.40	1	1.57	0.72	2.28
	0.714	0.43	1	0	0.44	1.30	1	1.46	0.72	2.11
	1.07	0.46	1	0	0.44	1.23	1	1.38	0.72	2.00
	1.43	0.47	1	0	0.44	1.19	1	1.34	0.72	1.93
	2.14	0.50	1	0	0.44	1.12	1	1.26	0.72	1.82
	3.57	0.55	1	0	0.44	1.02	1	1.14	0.72	1.66
	5.35	0.56	1	0	0.44	1.00	1	1.12	0.72	1.63
25°	—	0.68	1	0	0.41	0.87	1	0.92	0.67	1.41
30°	—	0.80	1	0	0.39	0.76	1	0.78	0.63	1.24
40°	—	1.14	1	0	0.35	0.57	1	0.55	0.57	0.93

*For i , use 2 for DB and DF and 1 for DT

Static Equivalent Load $P_0 = X_0 F_r + Y_0 F_a$

Contact Angle	Single, DT		DB or DF		Single or DT mounting When $F_a > 0.5 F_r + Y_0 F_a$ use $P_0 = F_r$
	X_0	Y_0	X_0	Y_0	
15°	0.5	0.46	1	0.92	
25°	0.5	0.38	1	0.76	
30°	0.5	0.33	1	0.66	
40°	0.5	0.26	1	0.52	

	Boundary Dimensions (mm)					Basic Load Ratings (Single)		Factor	Limiting Speeds (1)		Eff. Load Center (mm) a	Abutment and Fillet Dimensions (mm)			Mass (kg) approx.	Bearing Designations (2)				Basic Load Ratings (Matched)		Limiting Speeds (1) (Matched)		Load Center Spacings (mm)		Abutment and Fillet Dimensions (mm)		
	d	D	B	r min.	r_1 min.	C_r	C_{0r}		Grease	Oil		d_a min.	D_a max.	r_a max.		Single	Standard	Option	Arrangement	C_r	C_{0r}	Grease	Oil	DB	DF	a_0	DB	DF
85	120	18	1.1	0.6	36 500	38 500	—	6 700	9 000	32.9	92	113	1	0.541	7917 A5 (M) T, TYN	DB DF DT	59 500	77 000	5 300	7 500	65.8	29.8	—	115	0.6			
	120	18	1.1	0.6	39 000	40 500	16.5	8 000	11 000	22.7	92	113	1	0.534	7917 C (M) T, TYN	DB DF DT	63 000	81 500	6 300	9 000	45.5	9.5	—	115	0.6			
	130	22	1.1	0.6	56 500	56 000	—	4 300	5 600	42.0	92	123	1	0.913	7017 A W (M), T, TYN	DB DF DT	91 500	112 000	3 400	4 500	84.1	40.1	90	125	0.6			
	130	22	1.1	0.6	60 000	58 500	15.9	7 500	10 000	25.4	92	123	1	1.01	7017 C (M) W, T, TYN	DB DF DT	98 000	117 000	6 000	8 500	50.8	6.8	—	125	0.6			
	150	28	2	1	103 000	89 000	—	3 800	5 300	47.9	95	140	2	1.83	7217 A W (M), T, TYN	DB DF DT	167 000	178 000	3 000	4 300	95.8	39.8	91	144	1			
	150	28	2	1	93 000	81 000	—	2 800	3 800	63.3	95	140	2	1.87	7217 B W (M), T	DB DF DT	151 000	162 000	2 200	3 000	126.6	70.6	91	144	1			
	150	28	2	1	96 000	81 500	—	3 800	5 600	63.3	95	140	2	1.75	7217 BEA T85 MR	—	—	3 200	4 500	126.6	70.6	91	144	1				
	150	28	2	1	107 000	90 500	14.7	6 700	9 500	29.7	95	140	2	2.04	7217 C (M) W, T, TYN	DB DF DT	174 000	181 000	5 600	7 500	59.5	3.5	—	144	1			
	180	41	3	1.1	159 000	133 000	—	2 600	3 600	58.9	99	166	2.5	4.33	7317 A W (M), T	DB DF DT	258 000	265 000	2 200	2 800	117.5	35.5	92	173	1			
	180	41	3	1.1	146 000	122 000	—	2 400	3 200	76.1	99	166	2.5	4.42	7317 B W (M), T	DB DF DT	236 000	244 000	1 900	2 600	152.2	70.2	92	173	1			
	180	41	3	1.1	157 000	133 000	—	3 400	5 000	76.1	99	166	2.5	4.34	7317 BEA T85 MR, T7	—	—	2 800	4 000	152.2	70.2	92	173	1				
	90	125	18	1.1	0.6	39 500	43 500	—	6 300	8 500	34.1	97	118	1	0.560	7918 A5 (M) T, TYN	DB DF DT	64 000	87 000	5 000	7 100	68.1	32.1	—	120	0.6		
		125	18	1.1	0.6	41 500	46 000	16.6	7 500	10 000	23.4	97	118	1	0.563	7918 C (M) T, TYN	DB DF DT	67 500	92 000	6 000	8 500	46.8	10.8	—	120	0.6		
		140	24	1.5	1	67 500	66 500	—	3 800	5 300	45.2	99	131	1.5	1.19	7018 A W (M), T, TYN	DB DF DT	109 000	133 000	3 200	4 300	90.4	42.4	96	134	1		
		140	24	1.5	1	71 500	69 000	15.7	7 100	9 500	27.4	99	131	1.5	1.34	7018 C (M) W, T, TYN	DB DF DT	116 000	138 000	5 600	8 000	54.8	6.8	—	134	1		
		160	30	2	1	118 000	103 000	—	3 600	4 800	51.1	100	150	2	2.25	7218 A W (M), T, TYN	DB DF DT	191 000	206 000	2 800	4 000	102.2	42.2	96	154	1		
160		30	2	1	107 000	94 000	—	2 600	3 400	67.4	100	150	2	2.29	7218 B W (M), T	DB DF DT	173 000	188 000	2 000	2 800	134.9	74.9	96	154	1			
160		30	2	1	109 000	93 500	—	3 600	5 300	67.4	100	150	2	2.19	7218 BEA T85 MR	—	—	3 000	4 300	134.9	74.9	96	154	1				
160		30	2	1	123 000	105 000	14.6	6 300	9 000	31.7	100	150	2	2.51	7218 C (M) W, T, TYN	DB DF DT	199 000	209 000	5 300	7 100	63.5	3.5	—	154	1			
190		43	3	1.1	171 000	147 000	—	2 600	3 400	61.9	104	176	2.5	5.06	7318 A W (M), T	DB DF DT	277 000	294 000	2 000	2 800	123.8	37.8	97	183	1			
190		43	3	1.1	156 000	135 000	—	2 200	3 000	80.2	104	176	2.5	5.17	7318 B W (M), T	DB DF DT	254 000	270 000	1 800	2 400	160.5	74.5	97	183	1			
190		43	3	1.1	169 000	146 000	—	3 200	4 500	80.2	104	176	2.5	4.97	7318 BEA T85 MR	—	—	2 600	3 600	160.5	74.5	97	183	1				
95		130	18	1.1	0.6	40 000	45 500	—	6 000	8 500	35.2	102	123	1	0.597	7919 A5 (M) T, TYN	DB DF DT	64 500	91 000	4 800	6 700	70.5	34.5	—	125	0.6		
	130	18	1.1	0.6	42 500	48 000	16.7	7 100	10 000	24.1	102	123	1	0.591	7919 C (M) T, TYN	DB DF DT	68 500	96 000	5 600	8 000	48.1	12.1	—	125	0.6			
	145	24	1.5	1	67 000	67 000	—	4 500	6 300	46.6	104	136	1.5	1.43	7019 A W (M), T, TYN	DB DF DT	109 000	134 000	3 800	5 000	93.3	45.3	—	139	1			
	145	24	1.5	1	73 500	73 000	15.9	6 700	9 000	28.1	104	136	1.5	1.42	7019 C (M) T, TYN	DB DF DT	119 000	146 000	5 300	7 500	56.1	8.1	—	139	1			
	170	32	2.1	1.1	128 000	111 000	—	3 400	4 500	54.2	107	158	2	2.68	7219 A W (M), T, TYN	DB DF DT	208 000	221 000	2 600	3 600	108.5	44.5	102	163	1			
	170	32	2.1	1.1	116 000	101 000	—	2 400	3 200	71.6	107	158	2	2.74	7219 B W (M), T	DB DF DT	188 000	202 000	1 900	2 600	143.2	79.2	102	163	1			
	170	32	2.1	1.1	123 000	107 000	—	3 400	5 000	71.6	107	158	2	2.67	7219 BEA T85 MR, T7	—	—	2 800	4 000	143.2	79.2	102	163	1				
	170	32	2.1	1.1	133 000	112 000	14.6	6 000	8 500	33.7	107	158	2	3.05	7219 C (M) W, T, TYN	DB DF DT	216 000	224 000	4 800	6 700	67.5	3.5	—	163	1			
	200	45	3	1.1	183 000	162 000	—	2 400	3 200	65.1	109	186	2.5	5.83	7319 A W (M), T	DB DF DT	297 000	325 000	1 900	2 600	130.2	40.2	102	193	1			
	200	45	3	1.1	167 000	149 000	—	2 200	3 000	84.3	109	186	2.5	5.98	7319 B W (M), T	DB DF DT	272 000	298 000	1 700	2 400	168.7	78.7	102	193	1			
	200	45	3	1.1	180 000	160 000	—	3 000	4 500	84.3	109	186	2.5	5.82	7319 BEA T85 MR	—	—	2 400	3 600	168.7	78.7	102	193	1				
	100	140	20	1.1	0.6	47 500	51 500	—	5 600	8 000	38.0	107	133	1	0.804	7920 A5 (M) T, TYN	DB DF DT	77 000	103 000	4 500	6 300	76.0	36.0	—	135	0.6		
140		20	1.1	0.6	50 000	54 000	16.5	6 700	9 000	26.1	107	133	1	0.794	7920 C (M) T, TYN	DB DF DT	81 500	108 000	5 300	7 500	52.2	12.2	—	135	0.6			
150		24	1.5	1	68 500	70 500	—	4 500	6 000	48.1	109	141	1.5	1.48	7020 A W (M), T, TYN	DB DF DT	111 000	141 000	3 600	5 000	96.2	48.2	—	144	1			

Notes (1) For applications operating near the limiting speed, refer to Page C077.
 (2) Suffixes A, A5, B, and C represent contact angles of 30°, 25°, 40°, and 15° respectively.
 (3) Use the values of d_a (min) and r_a (max) for bearings with “—” in the d_b column.

<

ANGULAR CONTACT BALL BEARINGS

SINGLE/MATCHED MOUNTINGS

Bore Diameter 180 – 200 mm

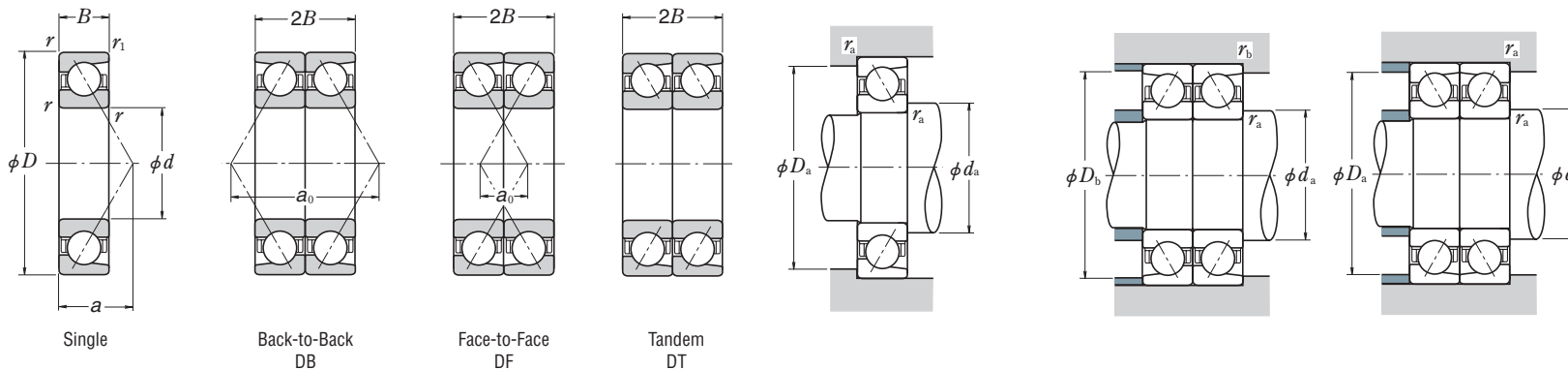

Dynamic Equivalent Load $P = XF_r + YF_a$

Contact Angle	$\frac{if_0 F_a}{C_{0r}}$	e	Single, DT				DB or DF			
			$F_a/F_r \leq e$		$F_a/F_r > e$		$F_a/F_r \leq e$		$F_a/F_r > e$	
			X	Y	X	Y	X	Y	X	Y
15°	0.178	0.38	1	0	0.44	1.47	1	1.65	0.72	2.39
	0.357	0.40	1	0	0.44	1.40	1	1.57	0.72	2.28
	0.714	0.43	1	0	0.44	1.30	1	1.46	0.72	2.11
	1.07	0.46	1	0	0.44	1.23	1	1.38	0.72	2.00
	1.43	0.47	1	0	0.44	1.19	1	1.34	0.72	1.93
	2.14	0.50	1	0	0.44	1.12	1	1.26	0.72	1.82
	3.57	0.55	1	0	0.44	1.02	1	1.14	0.72	1.66
	5.35	0.56	1	0	0.44	1.00	1	1.12	0.72	1.63
25°	—	0.68	1	0	0.41	0.87	1	0.92	0.67	1.41
30°	—	0.80	1	0	0.39	0.76	1	0.78	0.63	1.24
40°	—	1.14	1	0	0.35	0.57	1	0.55	0.57	0.93

*For i , use 2 for DB and DF and 1 for DT

Static Equivalent Load $P_0 = X_0 F_r + Y_0 F_a$

Contact Angle	Single, DT		DB or DF		Single or DT mounting When $F_r > 0.5 F_r + Y_0 F_a$ use $P_0 = F_r$
	X_0	Y_0	X_0	Y_0	
15°	0.5	0.46	1	0.92	
25°	0.5	0.38	1	0.76	
30°	0.5	0.33	1	0.66	
40°	0.5	0.26	1	0.52	

d	Boundary Dimensions (mm)					Basic Load Ratings (Single) (N)		Factor f_0	Limiting Speeds (1) (min ⁻¹)		Eff. Load Center (mm) a	Abutment and Fillet Dimensions (mm)			Mass (kg) approx.	Bearing Designations (2) Cage Designation (4)				Basic Load Ratings (Matched) (N)		Limiting Speeds (1) (Matched) (min ⁻¹)		Load Center Spacings (mm)		Abutment and Fillet Dimensions (mm)		
	D	B	r min.	r_1 min.	C_r	C_{0r}	Grease		Oil	d_a min.		D_a max.	r_a max.	Single		Standard	Option	Arrangement	C_r	C_{0r}	Grease	Oil	DB	DF	d_b (3) min.	D_b max.	r_b (3) max.	
	180	250	33	2	1	145 000	184 000		16.6	3 200		4 500	45.3	190		240	2	4.90	7936 C	(M)	—	DB DF DT	236 000	370 000	2 600	3 600	90.6	24.6
	280	46	2.1	1.1	207 000	252 000	—	1 900	2 400	89.4	192	268	2	10.5	7036 A	(M)	—	DB DF DT	335 000	505 000	1 500	2 000	178.8	86.8	—	273	1	
	320	52	4	1.5	305 000	385 000	—	1 700	2 200	98.2	198	302	3	18.1	7236 A	(M)	—	DB DF DT	495 000	770 000	1 400	1 800	196.3	92.3	—	311	1.5	
	320	52	4	1.5	276 000	350 000	—	1 500	2 000	130.9	198	302	3	18.4	7236 B	(M)	—	DB DF DT	450 000	700 000	1 200	1 700	261.8	157.8	—	311	1.5	
	380	75	4	1.5	410 000	535 000	—	1 500	2 000	118.3	198	362	3	42.1	7336 A	(M)	—	DB DF DT	665 000	1 070 000	1 200	1 600	236.6	86.6	—	371	1.5	
	380	75	4	1.5	375 000	490 000	—	1 300	1 800	155.0	198	362	3	42.6	7336 B	(M)	—	DB DF DT	605 000	975 000	1 100	1 500	309.9	159.9	—	371	1.5	
190	260	33	2	1	147 000	192 000	16.7	3 000	4 300	46.6	200	250	2	4.98	7938 C	(M)	TYN	DB DF DT	239 000	385 000	2 400	3 400	93.3	27.3	—	254	1	
	290	46	2.1	1.1	224 000	280 000	—	1 800	2 400	92.3	202	278	2	11.3	7038 A	(M)	—	DB DF DT	365 000	560 000	1 400	1 900	184.6	92.6	—	283	1	
	340	55	4	1.5	315 000	410 000	—	1 600	2 200	104.0	208	322	3	22.4	7238 A	(M)	—	DB DF DT	510 000	825 000	1 300	1 700	208.0	98.0	—	331	1.5	
	340	55	4	1.5	284 000	375 000	—	1 400	2 000	138.7	208	322	3	22.5	7238 B	(M)	—	DB DF DT	460 000	750 000	1 100	1 600	277.3	167.3	—	331	1.5	
	400	78	5	2	450 000	600 000	—	1 400	1 900	124.2	212	378	4	47.5	7338 A	(M)	T	DB DF DT	730 000	1 200 000	1 100	1 500	248.3	92.3	—	390	2	
	400	78	5	2	410 000	550 000	—	1 300	1 700	162.8	212	378	4	47.2	7338 B	(M)	—	DB DF DT	670 000	1 100 000	1 000	1 400	325.5	169.5	—	390	2	
200	280	38	2.1	1.1	189 000	244 000	16.5	2 800	4 000	51.2	212	268	2	6.85	7940 C	(M)	—	DB DF DT	305 000	490 000	2 200	3 200	102.3	26.3	—	273	1	
	310	51	2.1	1.1	240 000	310 000	—	1 700	2 200	99.1	212	298	2	13.7	7040 A	(M)	T	DB DF DT	390 000	620 000	1 300	1 800	198.2	96.2	—	303	1	
	360	58	4	1.5	335 000	450 000	—	1 500	2 000	109.8	218	342	3	26.5	7240 A	(M)	—	DB DF DT	550 000	900 000	1 200	1 600	219.6	103.6	—	351	1.5	
	360	58	4	1.5	305 000	410 000	—	1 300	1 800	146.5	218	342	3	26.6	7240 B	(M)	—	DB DF DT	495 000	815 000	1 100	1 500	292.9	176.9	—	351	1.5	
	420	80	5	2	475 000	660 000	—	1 300	1 800	129.5	222	398	4	54.4	7340 A	(M)	T	DB DF DT	770 000	1 320 000	1 100	1 400	259.0	99.0	—	410	2	
	420	80	5	2	430 000	600 000	—	1 200	1 600	170.1	222	398	4	55.3	7340 B	(M)	—	DB DF DT	700 000	1 200 000	950	1 300	340.1	180.1	—	410	2	

Notes (1) For applications operating near the limiting speed, refer to Page C077.
 (2) Suffixes A, A5, B, and C represent contact angles of 30°, 25°, 40°, and 15° respectively.
 (3) Use the values of d_a (min) and r_a (max) for bearings with “—” in the d_b column.

Note (4) Cage designation (M) is usually omitted from the bearing designation.

DOUBLE-ROW ANGULAR CONTACT BALL BEARINGS

Bore Diameter 10 – 45 mm

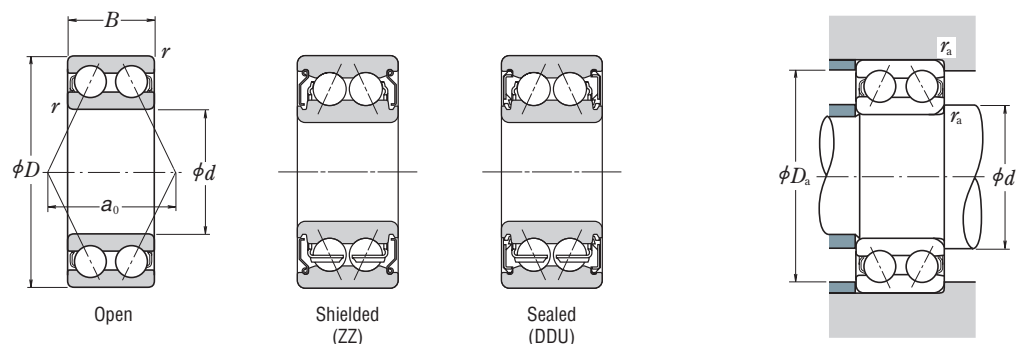

Dynamic Equivalent Load

$$P = XF_r + YF_a$$

$F_a/F_r \leq e$		$F_a/F_r > e$		e
X	Y	X	Y	
1	0.92	0.67	1.41	0.68

Static Equivalent Load

$$P_0 = F_r + 0.76 F_a$$

Boundary Dimensions (mm)				Basic Load Ratings (N)		Limiting Speeds (min ⁻¹)			Bearing Designations			Load Center Spacings (mm) a_0	Abutment and Fillet Dimensions (mm)			Mass (kg) approx.
d	D	B	r min.	C_r	C_{0r}	Grease		Oil	Open	Shielded	Sealed		d_a min.	D_a max.	r_a max.	
						Open ZZ	DDU	Open	Open	Shielded	Sealed					
10	30	14.3	0.6	7 150	3 900	17 000	—	22 000	5200	—	—	14.5	15	25	0.6	0.050
	30	14.3	0.6	7 150	3 900	17 000	15 000	—	—	5200ZZ	5200DDU	14.5	14	26	0.6	0.050
12	32	15.9	0.6	10 500	5 800	15 000	—	20 000	5201	—	—	16.7	17	27	0.6	0.060
	32	15.9	0.6	8 500	5 300	15 000	12 000	—	—	5201BZZ	5201BDDU	16.3	16	28	0.6	0.060
15	35	15.9	0.6	11 700	7 050	13 000	—	17 000	5202	—	—	18.3	20	30	0.6	0.070
	35	15.9	0.6	8 500	5 300	13 000	12 000	—	—	5202BZZ	5202BDDU	16.3	19	31	0.6	0.070
	42	19	1	17 600	10 200	11 000	—	15 000	5302	—	—	22	21	36	1	0.13
	42	19	1	14 700	9 100	11 000	10 000	—	—	5302AZZ	5302ADDU	21	21	36	1	0.13
17	40	17.5	0.6	14 600	9 050	11 000	—	15 000	5203	—	—	20.8	22	35	0.6	0.10
	40	17.5	0.6	12 700	8 300	11 000	10 000	—	—	5203AZZ	5203ADDU	20.1	21	36	0.6	0.10
	47	22.2	1	21 000	12 600	10 000	—	13 000	5303	—	—	25	23	41	1	0.18
	47	22.2	1	19 600	12 400	10 000	9 500	—	—	5303AZZ	5303ADDU	24.3	23	41	1	0.18
20	47	20.6	1	19 600	12 400	10 000	—	13 000	5204	—	—	24.3	26	41	1	0.16
	47	20.6	1	15 900	10 700	10 000	9 000	—	—	5204AZZ	5204ADDU	23	26	41	1	0.16
	52	22.2	1.1	24 600	15 000	9 000	—	12 000	5304	—	—	26.7	27	45	1	0.22
	52	22.2	1.1	19 700	12 800	9 000	8 500	—	—	5304AZZ	5304ADDU	25.4	27	45	1	0.22
25	52	20.6	1	21 300	14 700	8 500	—	11 000	5205	—	—	26.8	31	46	1	0.18
	52	20.6	1	16 900	12 300	8 500	7 500	—	—	5205BZZ	5205BDDU	25.4	31	46	1	0.18
	62	25.4	1.1	32 500	20 700	7 500	—	10 000	5305	—	—	31.8	32	55	1	0.35
	62	25.4	1.1	25 200	18 200	7 500	6 300	—	—	5305AZZ	5305ADDU	30.9	32	55	1	0.36
30	62	23.8	1	29 600	21 100	7 100	—	9 500	5206	—	—	31.6	36	56	1	0.30
	62	23.8	1	25 200	18 200	7 100	6 300	—	—	5206BZZ	5206BDDU	30.9	36	56	1	0.30
	72	30.2	1.1	40 500	28 100	6 300	—	8 500	5306	—	—	36.5	37	65	1	0.57
	72	30.2	1.1	39 000	28 700	6 300	5 300	—	—	5306AZZ	5306ADDU	36.6	37	65	1	0.57
35	72	27	1.1	39 000	28 700	6 300	—	8 000	5207	—	—	36.6	42	65	1	0.46
	72	27	1.1	34 000	25 300	6 300	5 300	—	—	5207AZZ	5207ADDU	36.3	42	65	1	0.46
	80	34.9	1.5	51 000	36 000	5 600	—	7 500	5307	—	—	41.6	44	71	1.5	0.76
	80	34.9	1.5	44 000	33 500	5 600	4 800	—	—	5307AZZ	5307ADDU	41.5	44	71	1.5	0.79
40	80	30.2	1.1	44 000	33 500	5 600	—	7 100	5208	—	—	41.5	47	73	1	0.62
	80	30.2	1.1	36 500	29 000	5 600	4 800	—	—	5208AZZ	5208ADDU	39.4	47	73	1	0.63
	90	36.5	1.5	56 500	41 000	5 300	—	6 700	5308	—	—	45.5	49	81	1.5	1.03
	90	36.5	1.5	49 500	38 000	5 300	4 500	—	—	5308AZZ	5308ADDU	43.8	49	81	1.5	1.05
45	85	30.2	1.1	49 500	38 000	5 000	—	6 700	5209	—	—	43.4	52	78	1	0.67
	85	30.2	1.1	41 500	33 500	5 000	4 300	—	—	5209A1ZZ	5209A1DDU	42.5	52	78	1	0.67
	100	39.7	1.5	68 500	51 000	4 500	—	6 000	5309	—	—	50.6	54	91	1.5	1.37

DOUBLE-ROW ANGULAR CONTACT BALL BEARINGS

Bore Diameter 50 – 85 mm

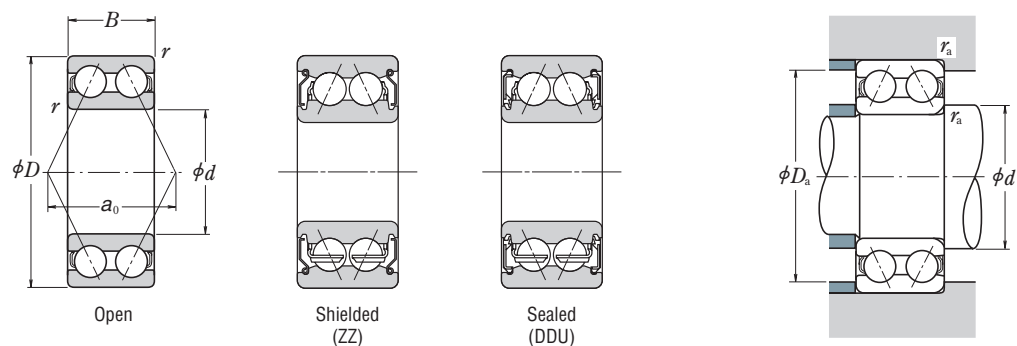

Dynamic Equivalent Load

$$P = XF_r + YF_a$$

$F_a/F_r \leq e$		$F_a/F_r > e$		e
X	Y	X	Y	
1	0.92	0.67	1.41	0.68

Static Equivalent Load

$$P_0 = F_r + 0.76 F_a$$

Boundary Dimensions (mm)				Basic Load Ratings (N)		Limiting Speeds (min ⁻¹)			Bearing Designations			Load Center Spacings (mm) a_0	Abutment and Fillet Dimensions (mm)			Mass (kg) approx.
d	D	B	r min.	C_r	C_{0r}	Grease		Oil	Open	Shielded	Sealed		d_a min.	D_a max.	r_a max.	
						Open ZZ	DDU	Open								
50	90	30.2	1.1	53 000	43 500	4 800	—	6 000	5210	—	—	45.9	57	83	1	0.72
	90	30.2	1.1	40 500	36 000	4 800	4 000	—	—	5210AZZ	5210ADDU	44	57	83	1	0.73
	110	44.4	2	81 500	61 500	4 300	—	5 600	5310	—	—	55.6	60	100	2	1.84
55	100	33.3	1.5	56 000	49 000	4 300	—	5 600	5211	—	—	50.1	64	91	1.5	1.01
	100	33.3	1.5	49 500	43 500	4 300	3 600	—	—	5211AZZ	5211ADDU	49.2	64	91	1.5	1.01
	120	49.2	2	95 000	73 000	3 800	—	5 000	5311	—	—	60.6	65	110	2	2.40
60	110	36.5	1.5	69 000	62 000	3 800	—	5 000	5212	—	—	56.5	69	101	1.5	1.33
	130	54	2.1	125 000	98 500	3 400	—	4 500	5312	—	—	69.2	72	118	2	2.92
65	120	38.1	1.5	76 500	69 000	3 600	—	4 500	5213	—	—	59.7	74	111	1.5	1.71
	140	58.7	2.1	142 000	113 000	3 200	—	4 300	5313	—	—	72.8	77	128	2	3.67
70	125	39.7	1.5	94 000	82 000	3 400	—	4 500	5214	—	—	63.8	79	116	1.5	1.75
	150	63.5	2.1	159 000	128 000	3 000	—	3 800	5314	—	—	78.3	82	138	2	4.55
75	130	41.3	1.5	93 500	83 000	3 200	—	4 300	5215	—	—	66.1	84	121	1.5	1.88
80	140	44.4	2	99 000	93 000	3 000	—	3 800	5216	—	—	69.6	90	130	2	2.51
85	150	49.2	2	116 000	110 000	2 800	—	3 600	5217	—	—	75.3	95	140	2	3.16

FOUR-POINT-CONTACT BALL BEARINGS

Bore Diameter 30 – 95 mm

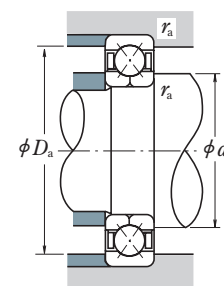
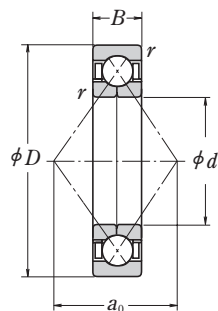

Dynamic Equivalent Load

$$P_a = F_a$$

Static Equivalent Load

$$P_{0a} = F_a$$

d	Boundary Dimensions (mm)			Basic Load Ratings (N)		Limiting Speeds (min ⁻¹)		Bearing Designation	Load Center Spacing (mm) a ₀	Abutment and Fillet Dimensions (mm)			Mass (kg) approx.
	D	B	r min.	C _a	C _{0a}	Grease	Oil			d _a min.	D _a max.	r _a max.	
30	62	16	1	31 000	45 000	8 500	12 000	QJ 206	32.2	36	56	1	0.24
	72	19	1.1	46 000	63 000	8 000	11 000	QJ 306	35.7	37	65	1	0.42
35	72	17	1.1	41 000	61 500	7 500	10 000	QJ 207	37.5	42	65	1	0.35
	80	21	1.5	55 000	80 000	7 100	9 500	QJ 307	40.3	44	71	1.5	0.57
40	80	18	1.1	49 000	77 500	6 700	9 000	QJ 208	42.0	47	73	1	0.45
	90	23	1.5	67 000	100 000	6 300	8 500	QJ 308	45.5	49	81	1.5	0.78
45	85	19	1.1	55 000	88 500	6 300	8 500	QJ 209	45.5	52	78	1	0.52
	100	25	1.5	87 500	133 000	5 600	7 500	QJ 309	50.8	54	91	1.5	1.05
50	90	20	1.1	57 000	97 000	5 600	8 000	QJ 210	49.0	57	83	1	0.59
	110	27	2	102 000	159 000	5 000	6 700	QJ 310	56.0	60	100	2	1.35
55	100	21	1.5	71 000	122 000	5 300	7 100	QJ 211	54.3	64	91	1.5	0.77
	120	29	2	118 000	187 000	4 500	6 300	QJ 311	61.3	65	110	2	1.75
60	110	22	1.5	85 500	150 000	4 800	6 300	QJ 212	59.5	69	101	1.5	0.98
	130	31	2.1	135 000	217 000	4 300	5 600	QJ 312	66.5	72	118	2	2.15
65	120	23	1.5	97 500	179 000	4 300	6 000	QJ 213	64.8	74	111	1.5	1.2
	140	33	2.1	153 000	250 000	3 800	5 300	QJ 313	71.8	77	128	2	2.7
70	125	24	1.5	106 000	197 000	4 000	5 600	QJ 214	68.3	79	116	1.5	1.3
	150	35	2.1	172 000	285 000	3 600	5 000	QJ 314	77.0	82	138	2	3.18
75	130	25	1.5	110 000	212 000	3 800	5 300	QJ 215	71.8	84	121	1.5	1.5
	160	37	2.1	187 000	320 000	3 400	4 800	QJ 315	82.3	87	148	2	3.9
80	125	22	1.1	77 000	167 000	3 800	5 300	QJ 1016	71.8	87	118	1	1.05
	140	26	2	124 000	236 000	3 600	5 000	QJ 216	77.0	90	130	2	1.85
	170	39	2.1	202 000	360 000	3 200	4 300	QJ 316	87.5	92	158	2	4.6
85	130	22	1.1	79 000	176 000	3 800	5 000	QJ 1017	75.3	92	123	1	1.1
	150	28	2	143 000	276 000	3 400	4 800	QJ 217	82.3	95	140	2	2.2
	180	41	3	218 000	405 000	3 000	4 000	QJ 317	92.8	99	166	2.5	5.34
90	140	24	1.5	94 000	208 000	3 400	4 800	QJ 1018	80.5	99	131	1.5	1.45
	160	30	2	164 000	320 000	3 200	4 300	QJ 218	87.5	100	150	2	2.75
	190	43	3	235 000	450 000	2 800	3 800	QJ 318	98.0	104	176	2.5	6.4
95	145	24	1.5	96 500	220 000	3 400	4 500	QJ 1019	84.0	104	136	1.5	1.5
	170	32	2.1	177 000	340 000	3 000	4 000	QJ 219	92.8	107	158	2	3.35
	200	45	3	251 000	495 000	2 600	3 600	QJ 319	103.3	109	186	2.5	7.4

Remark Please contact NSK when using four-point contact ball bearings.

FOUR-POINT-CONTACT BALL BEARINGS

Bore Diameter 100 – 200 mm

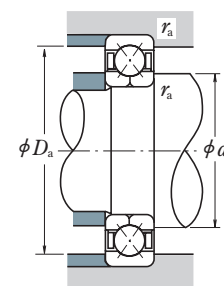
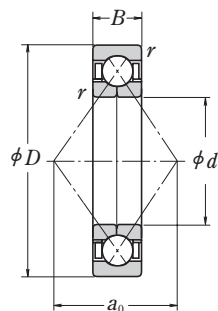

Dynamic Equivalent Load

$$P_a = F_a$$

Static Equivalent Load

$$P_{0a} = F_a$$

d	Boundary Dimensions (mm)			Basic Load Ratings (N)		Limiting Speeds (min ⁻¹)		Bearing Designation	Load Center Spacing (mm) a ₀	Abutment and Fillet Dimensions (mm)			Mass (kg) approx.
	D	B	r min.	C _a	C _{0a}	Grease	Oil			d _a min.	D _a max.	r _a max.	
100	150	24	1.5	98 500	232 000	3 200	4 300	QJ 1020	87.5	109	141	1.5	1.6
	180	34	2.1	199 000	390 000	2 800	3 800	QJ 220	98.0	112	168	2	4.0
	215	47	3	300 000	640 000	2 400	3 400	QJ 320	110.3	114	201	2.5	9.3
105	160	26	2	115 000	269 000	3 000	4 000	QJ 1021	92.8	115	150	2	2.0
	190	36	2.1	217 000	435 000	2 600	3 600	QJ 221	103.3	117	178	2	4.7
	225	49	3	305 000	640 000	2 400	3 200	QJ 321	115.5	119	211	2.5	10.5
110	170	28	2	139 000	315 000	2 800	3 800	QJ 1022	98.0	120	160	2	2.5
	200	38	2.1	235 000	490 000	2 600	3 400	QJ 222	108.5	122	188	2	5.6
	240	50	3	320 000	710 000	2 200	3 000	QJ 322	122.5	124	226	2.5	12.5
120	180	28	2	147 000	350 000	2 600	3 600	QJ 1024	105.0	130	170	2	2.65
	215	40	2.1	265 000	585 000	2 400	3 200	QJ 224	117.3	132	203	2	6.9
	260	55	3	360 000	835 000	2 000	2 800	QJ 324	133.0	134	246	2.5	15.4
130	200	33	2	169 000	415 000	2 400	3 200	QJ 1026	115.5	140	190	2	4.0
	230	40	3	274 000	635 000	2 200	3 000	QJ 226	126.0	144	216	2.5	7.7
	280	58	4	400 000	970 000	1 900	2 600	QJ 326	143.5	148	262	3	19
140	210	33	2	172 000	435 000	2 200	3 000	QJ 1028	122.5	150	200	2	4.3
	250	42	3	315 000	775 000	2 000	2 800	QJ 228	136.5	154	236	2.5	9.8
	300	62	4	440 000	1 110 000	1 700	2 400	QJ 328	154.0	158	282	3	24
150	225	35	2.1	197 000	505 000	2 000	2 800	QJ 1030	131.3	162	213	2	5.2
	270	45	3	360 000	925 000	1 800	2 600	QJ 230	147.0	164	256	2.5	12
	320	65	4	460 000	1 230 000	1 600	2 200	QJ 330	164.5	168	302	3	29
160	240	38	2.1	224 000	580 000	1 900	2 600	QJ 1032	140.0	172	228	2	6.4
	290	48	3	380 000	1 010 000	1 700	2 400	QJ 232	157.5	174	276	2.5	15
	340	68	4	505 000	1 400 000	1 500	2 000	QJ 332	175.1	178	322	3	31
170	260	42	2.1	268 000	705 000	1 800	2 400	QJ 1034	150.5	182	248	2	8.6
	310	52	4	425 000	1 180 000	1 600	2 200	QJ 234	168.0	188	292	3	19.5
	360	72	4	565 000	1 610 000	1 400	2 000	QJ 334	185.6	188	342	3	41
180	280	46	2.1	299 000	830 000	1 700	2 200	QJ 1036	161.0	192	268	2	11
	320	52	4	440 000	1 270 000	1 500	2 000	QJ 236	175.1	198	302	3	20.5
	380	75	4	595 000	1 770 000	1 300	1 800	QJ 336	196.1	198	362	3	48
190	290	46	2.1	325 000	925 000	1 600	2 200	QJ 1038	168.0	202	278	2	11.5
	340	55	4	440 000	1 290 000	1 400	2 000	QJ 238	185.6	208	322	3	23
	400	78	5	655 000	1 980 000	1 300	1 700	QJ 338	206.6	212	378	4	54.5
200	310	51	2.1	345 000	1 020 000	1 500	2 000	QJ 1040	178.6	212	298	2	15
	360	58	4	490 000	1 480 000	1 300	1 800	QJ 240	196.1	218	342	3	27
	420	80	5	690 000	2 180 000	1 200	1 600	QJ 340	217.1	222	398	4	61.5

Remark Please contact NSK when using four-point contact ball bearings.

4. SELF-ALIGNING BALL BEARINGS

INTRODUCTION C 116

BEARING TABLES

SELF-ALIGNING BALL BEARINGS

Bore Diameter 5 – 110 mm C 118



DESIGN, TYPES, AND FEATURES

The outer ring of a self-aligning ball bearing has a spherical raceway and its center of curvature coincides with that of the bearing; therefore, the axis of the inner ring, balls and cage can deflect to some extent around the bearing center. This type is recommended when the alignment of the shaft and housing is difficult and when the shaft may bend. Since the contact angle is small, axial load capacity is low. Pressed-steel cages are usually used.

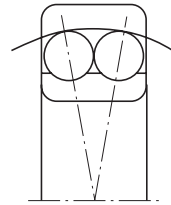

PROTRUSION AMOUNT

Some self-aligning ball bearings have balls that protrude from the side face as shown below. This protrusion amount b_1 is listed in the following table.

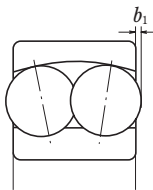

Bearing Designation	b_1 (mm)
2222(K), 2316(K)	0.5
2319(K), 2320(K) 2321, 2322(K)	0.5
1318(K)	1.5
1319(K)	2
1320(K), 1321 1322(K)	3

TOLERANCES AND RUNNING

ACCURACY Table 7.2 (Pages A128 to A131)

RECOMMENDED FITS Table 8.3 (Page A164)
..... Table 8.5 (Page A165)

INTERNAL CLEARANCE Table 8.13 (Page A170)

PERMISSIBLE MISALIGNMENT

The permissible misalignment of self-aligning ball bearings is approximately 0.07 to 0.12 radian (4° to 7°) under normal loads. However, depending on the surrounding structure, such an angle may not be possible. Take care in the design of the bearing surroundings.

SELF-ALIGNING BALL BEARINGS

Bore Diameter 5 – 30 mm

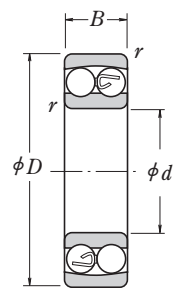

Cylindrical Bore

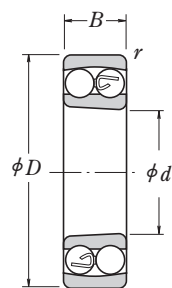

Tapered Bore

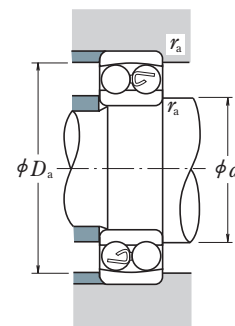

Dynamic Equivalent Load

$$P = X F_r + Y F_a$$

$F_a / F_r \leq e$		$F_a / F_r > e$	
X	Y	X	Y
1	Y_3	0.65	Y_2

Static Equivalent Load

$$P_0 = F_r + Y_0 F_a$$

The values of e , Y_2 , Y_3 , and Y_0 are listed in the table below.

Boundary Dimensions (mm)				Basic Load Ratings (N)		Limiting Speeds (min ⁻¹)		Bearing Designations	Abutment and Fillet Dimensions (mm)			Constant e	Axial Load Factors			Mass (kg) approx.	
d	D	B	r min.	C_r	C_{0r}	Grease	Oil		Cylindrical Bore	Tapered Bore ⁽¹⁾	d_a min.		D_a max.	r_a max.	Y_2		Y_3
5	19	6	0.3	2 530	475	30 000	36 000	135	—	7	17	0.3	0.34	2.9	1.9	1.9	0.009
6	19	6	0.3	2 530	475	30 000	36 000	126	—	8	17	0.3	0.34	2.9	1.9	1.9	0.008
7	22	7	0.3	2 750	600	26 000	32 000	127	—	9	20	0.3	0.31	3.1	2.0	2.1	0.013
8	22	7	0.3	2 750	600	26 000	32 000	108	—	10	20	0.3	0.31	3.1	2.0	2.1	0.016
9	26	8	0.6	4 150	895	26 000	30 000	129	—	13	22	0.6	0.32	3.1	2.0	2.1	0.021
10	30	9	0.6	5 550	1 190	22 000	28 000	1200	—	14	26	0.6	0.32	3.1	2.0	2.1	0.034
	30	14	0.6	7 450	1 590	24 000	28 000	2200	—	14	26	0.6	0.64	1.5	0.98	1.0	0.046
	35	11	0.6	7 350	1 620	20 000	24 000	1300	—	14	31	0.6	0.35	2.8	1.8	1.9	0.059
	35	17	0.6	9 200	2 010	18 000	22 000	2300	—	14	31	0.6	0.71	1.4	0.89	0.93	0.080
12	32	10	0.6	5 700	1 270	22 000	26 000	1201	—	16	28	0.6	0.36	2.7	1.8	1.8	0.041
	32	14	0.6	7 750	1 730	22 000	26 000	2201	—	16	28	0.6	0.58	1.7	1.1	1.1	0.051
	37	12	1	9 650	2 160	18 000	22 000	1301	—	17	32	1	0.33	2.9	1.9	2.0	0.068
	37	17	1	12 100	2 730	17 000	22 000	2301	—	17	32	1	0.60	1.6	1.1	1.1	0.089
15	35	11	0.6	7 600	1 750	18 000	22 000	1202	—	19	31	0.6	0.32	3.1	2.0	2.1	0.050
	35	14	0.6	7 800	1 850	18 000	22 000	2202	—	19	31	0.6	0.50	1.9	1.3	1.3	0.058
	42	13	1	9 700	2 290	16 000	20 000	1302	—	20	37	1	0.33	2.9	1.9	2.0	0.101
	42	17	1	12 300	2 910	14 000	18 000	2302	—	20	37	1	0.51	1.9	1.2	1.3	0.116
17	40	12	0.6	8 000	2 010	16 000	20 000	1203	—	21	36	0.6	0.31	3.1	2.0	2.1	0.074
	40	16	0.6	9 950	2 420	16 000	20 000	2203	—	21	36	0.6	0.50	1.9	1.3	1.3	0.089
	47	14	1	12 700	3 200	14 000	17 000	1303	—	22	42	1	0.32	3.1	2.0	2.1	0.13
	47	19	1	14 700	3 550	13 000	16 000	2303	—	22	42	1	0.51	1.9	1.2	1.3	0.16
20	47	14	1	10 000	2 610	14 000	17 000	1204	1204 K	25	42	1	0.29	3.4	2.2	2.3	0.12
	47	18	1	12 800	3 300	14 000	17 000	2204	2204 K	25	42	1	0.47	2.1	1.3	1.4	0.142
	52	15	1.1	12 600	3 350	12 000	15 000	1304	1304 K	26.5	45.5	1	0.29	3.4	2.2	2.3	0.164
	52	21	1.1	18 500	4 700	11 000	14 000	2304	2304 K	26.5	45.5	1	0.50	1.9	1.2	1.3	0.210
25	52	15	1	12 200	3 300	12 000	14 000	1205	1205 K	30	47	1	0.28	3.5	2.3	2.4	0.14
	52	18	1	12 400	3 450	12 000	14 000	2205	2205 K	30	47	1	0.41	2.4	1.5	1.6	0.16
	62	17	1.1	18 200	5 000	10 000	13 000	1305	1305 K	31.5	55.5	1	0.28	3.5	2.3	2.4	0.261
	62	24	1.1	24 900	6 600	9 500	12 000	2305	2305 K	31.5	55.5	1	0.47	2.1	1.4	1.4	0.340
30	62	16	1	15 800	4 650	10 000	12 000	1206	1206 K	35	57	1	0.25	3.9	2.5	2.6	0.22
	62	20	1	15 300	4 550	10 000	12 000	2206	2206 K	35	57	1	0.38	2.5	1.6	1.7	0.262
	72	19	1.1	21 400	6 300	8 500	11 000	1306	1306 K	36.5	65.5	1	0.26	3.7	2.4	2.5	0.391
	72	27	1.1	32 000	8 750	8 000	10 000	2306	2306 K	36.5	65.5	1	0.44	2.2	1.4	1.5	0.51

Note (1) Suffix K represents bearings with tapered bores (1 : 12).

Remark For dimensions related to adapters, refer to Page C348.

SELF-ALIGNING BALL BEARINGS

Bore Diameter 35 – 70 mm

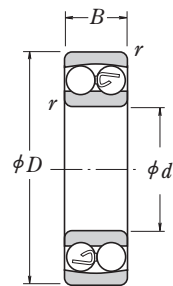

Cylindrical Bore

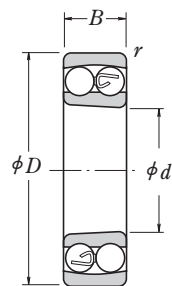

Tapered Bore

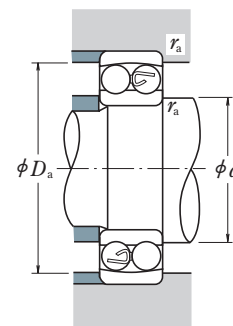

Dynamic Equivalent Load

$$P = XF_r + YF_a$$

$F_a/F_r \leq e$		$F_a/F_r > e$	
X	Y	X	Y
1	Y_3	0.65	Y_2

Static Equivalent Load

$$P_0 = F_r + Y_0 F_a$$

The values of e , Y_2 , Y_3 , and Y_0 are listed in the table below.

Boundary Dimensions (mm)				Basic Load Ratings (N)		Limiting Speeds (min ⁻¹)		Bearing Designations	Abutment and Fillet Dimensions (mm)			Constant e	Axial Load Factors			Mass (kg) approx.	
d	D	B	r min.	C_r	C_{0r}	Grease	Oil		Cylindrical Bore	Tapered Bore ⁽¹⁾	d_a min.		D_a max.	r_a max.	Y_2		Y_3
35	72	17	1.1	15 900	5 100	8 500	10 000	1207	1207 K	41.5	65.5	1	0.23	4.2	2.7	2.8	0.33
	72	23	1.1	21 700	6 600	8 500	10 000	2207	2207 K	41.5	65.5	1	0.37	2.6	1.7	1.8	0.403
	80	21	1.5	25 300	7 850	7 500	9 500	1307	1307 K	43	72	1.5	0.26	3.8	2.5	2.6	0.52
	80	31	1.5	40 000	11 300	7 100	9 000	2307	2307 K	43	72	1.5	0.46	2.1	1.4	1.4	0.687
40	80	18	1.1	19 300	6 500	7 500	9 000	1208	1208 K	46.5	73.5	1	0.22	4.3	2.8	2.9	0.42
	80	23	1.1	22 400	7 350	7 500	9 000	2208	2208 K	46.5	73.5	1	0.33	3.0	1.9	2.0	0.506
	90	23	1.5	29 800	9 700	6 700	8 500	1308	1308 K	48	82	1.5	0.24	4.0	2.6	2.7	0.727
	90	33	1.5	45 500	13 500	6 300	8 000	2308	2308 K	48	82	1.5	0.43	2.3	1.5	1.5	0.940
45	85	19	1.1	22 000	7 350	7 100	8 500	1209	1209 K	51.5	78.5	1	0.21	4.7	3.0	3.1	0.47
	85	23	1.1	23 300	8 150	7 100	8 500	2209	2209 K	51.5	78.5	1	0.30	3.2	2.1	2.2	0.556
	100	25	1.5	38 500	12 700	6 000	7 500	1309	1309 K	53	92	1.5	0.25	4.0	2.6	2.7	0.971
	100	36	1.5	55 000	16 700	5 600	7 100	2309	2309 K	53	92	1.5	0.41	2.4	1.5	1.6	1.3
50	90	20	1.1	22 800	8 100	6 300	8 000	1210	1210 K	56.5	83.5	1	0.21	4.7	3.1	3.2	0.535
	90	23	1.1	23 300	8 450	6 300	8 000	2210	2210 K	56.5	83.5	1	0.28	3.4	2.2	2.3	0.598
	110	27	2	43 500	14 100	5 600	6 700	1310	1310 K	59	101	2	0.23	4.2	2.7	2.8	1.23
	110	40	2	65 000	20 200	5 000	6 300	2310	2310 K	59	101	2	0.42	2.3	1.5	1.6	1.66
55	100	21	1.5	26 900	10 000	6 000	7 100	1211	1211 K	63	92	1.5	0.20	4.9	3.2	3.3	0.708
	100	25	1.5	26 700	9 900	6 000	7 100	2211	2211 K	63	92	1.5	0.28	3.5	2.3	2.4	0.807
	120	29	2	51 500	17 900	5 000	6 300	1311	1311 K	64	111	2	0.23	4.2	2.7	2.8	1.6
	120	43	2	76 500	24 000	4 800	6 000	2311	2311 K	64	111	2	0.41	2.4	1.5	1.6	2.12
60	110	22	1.5	30 500	11 500	5 300	6 300	1212	1212 K	68	102	1.5	0.18	5.3	3.4	3.6	0.91
	110	28	1.5	34 000	12 600	5 300	6 300	2212	2212 K	68	102	1.5	0.28	3.5	2.3	2.4	1.1
	130	31	2.1	57 500	20 800	4 500	5 600	1312	1312 K	71	119	2	0.23	4.3	2.8	2.9	2.0
	130	46	2.1	88 500	28 300	4 300	5 300	2312	2312 K	71	119	2	0.40	2.4	1.6	1.6	2.63
65	120	23	1.5	31 000	12 500	4 800	6 000	1213	1213 K	73	112	1.5	0.17	5.7	3.7	3.8	1.16
	120	31	1.5	43 500	16 400	4 800	6 000	2213	2213 K	73	112	1.5	0.28	3.5	2.3	2.4	1.5
	140	33	2.1	62 500	22 900	4 300	5 300	1313	1313 K	76	129	2	0.23	4.2	2.7	2.9	2.47
	140	48	2.1	97 000	32 500	3 800	4 800	2313	2313 K	76	129	2	0.39	2.5	1.6	1.7	3.3
70	125	24	1.5	35 000	13 800	4 800	5 600	1214	—	78	117	1.5	0.18	5.3	3.4	3.6	1.3
	125	31	1.5	44 000	17 100	4 500	5 600	2214	—	78	117	1.5	0.26	3.7	2.4	2.5	1.55
	150	35	2.1	75 000	27 700	4 000	5 000	1314	—	81	139	2	0.22	4.4	2.8	3.0	3.03
	150	51	2.1	111 000	37 500	3 600	4 500	2314	—	81	139	2	0.38	2.6	1.7	1.8	4.0

Note (1) Suffix K represents bearings with tapered bores (1 : 12).

Remark For dimensions related to adapters, refer to Pages C348 and C349.

SELF-ALIGNING BALL BEARINGS

Bore Diameter 75 – 110 mm

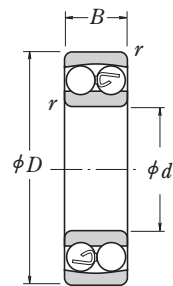

Cylindrical Bore

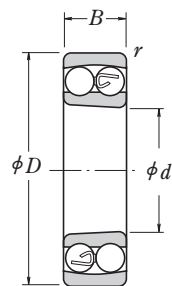

Tapered Bore

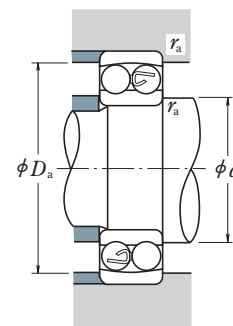

Dynamic Equivalent Load

$$P = X F_r + Y F_a$$

$F_a / F_r \leq e$		$F_a / F_r > e$	
X	Y	X	Y
1	Y_3	0.65	Y_2

Static Equivalent Load

$$P_0 = F_r + Y_0 F_a$$

The values of e , Y_2 , Y_3 , and Y_0 are listed in the table below.

Boundary Dimensions (mm)				Basic Load Ratings (N)		Limiting Speeds (min ⁻¹)		Bearing Designations	Abutment and Fillet Dimensions (mm)			Constant e	Axial Load Factors			Mass (kg) approx.	
d	D	B	r min.	C_r	C_{0r}	Grease	Oil		Cylindrical Bore	Tapered Bore ⁽¹⁾	d_a min.		D_a max.	r_a max.	Y_2		Y_3
75	130	25	1.5	39 000	15 700	4 300	5 300	1215	1215 K	83	122	1.5	0.17	5.6	3.6	3.8	1.36
	130	31	1.5	44 500	17 800	4 300	5 300	2215	2215 K	83	122	1.5	0.25	3.9	2.5	2.6	1.6
	160	37	2.1	80 000	30 000	3 800	4 500	1315	1315 K	86	149	2	0.22	4.4	2.8	2.9	3.63
	160	55	2.1	125 000	43 000	3 400	4 300	2315	2315 K	86	149	2	0.38	2.5	1.6	1.7	4.84
80	140	26	2	40 000	17 000	4 000	5 000	1216	1216 K	89	131	2	0.16	6.0	3.9	4.1	1.68
	140	33	2	49 000	19 900	4 000	5 000	2216	2216 K	89	131	2	0.25	3.9	2.5	2.7	2.02
	170	39	2.1	89 000	33 000	3 600	4 300	1316	1316 K	91	159	2	0.22	4.5	2.9	3.1	4.24
	170	58	2.1	130 000	45 000	3 200	4 000	* 2316	* 2316 K	91	159	2	0.39	2.5	1.6	1.7	5.75
85	150	28	2	49 500	20 800	3 800	4 500	1217	1217 K	94	141	2	0.17	5.7	3.7	3.8	2.1
	150	36	2	58 500	23 600	3 800	4 800	2217	2217 K	94	141	2	0.25	3.9	2.5	2.6	2.56
	180	41	3	98 500	38 000	3 400	4 000	1317	1317 K	98	167	2.5	0.21	4.6	2.9	3.1	5.03
	180	60	3	142 000	51 500	3 000	3 800	2317	2317 K	98	167	2.5	0.37	2.6	1.7	1.8	6.68
90	160	30	2	57 500	23 500	3 600	4 300	1218	1218 K	99	151	2	0.17	5.8	3.8	3.9	2.56
	160	40	2	70 500	28 700	3 600	4 300	2218	2218 K	99	151	2	0.27	3.7	2.4	2.5	3.22
	190	43	3	117 000	44 500	3 200	3 800	* 1318	* 1318 K	103	177	2.5	0.22	4.3	2.8	2.9	5.83
	190	64	3	154 000	57 500	2 800	3 600	2318	2318 K	103	177	2.5	0.38	2.6	1.7	1.7	7.87
95	170	32	2.1	64 000	27 100	3 400	4 000	1219	1219 K	106	159	2	0.17	5.8	3.7	3.9	3.12
	170	43	2.1	84 000	34 500	3 400	4 000	2219	2219 K	106	159	2	0.27	3.7	2.4	2.5	3.96
	200	45	3	129 000	51 000	3 000	3 600	* 1319	* 1319 K	108	187	2.5	0.23	4.3	2.8	2.9	6.79
	200	67	3	161 000	64 500	2 800	3 400	* 2319	* 2319 K	108	187	2.5	0.38	2.6	1.7	1.8	9.09
100	180	34	2.1	69 500	29 700	3 200	3 800	1220	1220 K	111	169	2	0.17	5.6	3.6	3.8	3.74
	180	46	2.1	94 500	38 500	3 200	3 800	2220	2220 K	111	169	2	0.27	3.7	2.4	2.5	4.71
	215	47	3	140 000	57 500	2 800	3 400	* 1320	* 1320 K	113	202	2.5	0.24	4.1	2.7	2.8	8.4
	215	73	3	187 000	79 000	2 400	3 200	* 2320	* 2320 K	113	202	2.5	0.38	2.6	1.7	1.8	11.7
105	190	36	2.1	75 000	32 500	3 000	3 600	1221	—	116	179	2	0.18	5.5	3.6	3.7	4.43
	190	50	2.1	109 000	45 000	3 000	3 600	2221	—	116	179	2	0.28	3.5	2.3	2.4	5.73
	225	49	3	154 000	64 500	2 600	3 200	* 1321	—	118	212	2.5	0.23	4.2	2.7	2.9	9.58
	225	77	3	200 000	87 000	2 400	3 000	* 2321	—	118	212	2.5	0.38	2.6	1.7	1.7	14.5
110	200	38	2.1	87 000	38 500	2 800	3 400	1222	1222 K	121	189	2	0.17	5.7	3.7	3.9	5.21
	200	53	2.1	122 000	51 500	2 800	3 400	* 2222	* 2222 K	121	189	2	0.28	3.5	2.2	2.3	6.75
	240	50	3	161 000	72 000	2 400	3 000	* 1322	* 1322 K	123	227	2.5	0.22	4.4	2.8	3.0	11.5
	240	80	3	211 000	94 500	2 200	2 800	* 2322	* 2322 K	123	227	2.5	0.37	2.6	1.7	1.8	17.5

Notes (1) Suffix K represents bearings with tapered bores (1 : 12).

(*) The balls of the bearings marked * protrude slightly from the bearing face. The protrusion amounts are shown on Page C114.

Remark For dimensions related to adapters, refer to Pages C350 and C351.

5. CYLINDRICAL ROLLER BEARINGS

SINGLE-ROW AND DOUBLE-ROW CYLINDRICAL ROLLER BEARINGS

INTRODUCTION C 126

TECHNICAL DATA

Free Space of Cylindrical Roller Bearings C 130

BEARING TABLES

Single-Row Cylindrical Roller Bearings

Bore Diameter 20 – 500 mm C 132

L-Shaped Thrust Collars For Cylindrical Roller Bearings

Bore Diameter 20 – 320 mm C 156

Double-Row Cylindrical Roller Bearings

Bore Diameter 25 – 360 mm C 158

FULL COMPLEMENT CYLINDRICAL ROLLER BEARINGS

SINGLE-ROW(NCF), DOUBLE-ROW(NNCF) AND FOR SHEAVES

INTRODUCTION C 162

BEARING TABLES

Single-Row(NCF) Bore Diameter 100 – 800 mm C 166

Double-Row(NNCF) Bore Diameter 100 – 500 mm C 170

For Sheaves: Open Fixed-End Bearings **RS-48E4, RS-49E4**

Free-End Bearings **RSF-48E4, RSF-49E4**

Bore Diameter 50 – 560 mm C 174

For Sheaves: Prelubricated Type **RS-50, RS-50NR**

Bore Diameter 40 – 400 mm C 178



DESIGN, TYPES, AND FEATURES

Cylindrical roller bearings are classified into the following types depending on whether or not they have ribs on their rings:

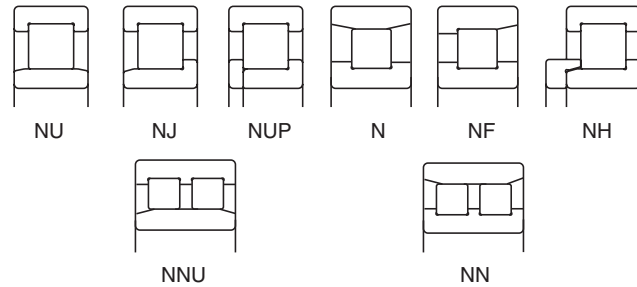

Types NU, N, NNU, and NN are suitable as free-end bearings. Types NJ and NF can sustain limited axial loads in one direction. Types NH and NUP can be used as fixed-end bearings.

The NH type consists of NJ-type cylindrical roller bearings and HJ-type L-shaped thrust collars (see Pages C156 and C157).

The inner ring loose rib of the NUP type should be mounted so that the marked side is on the outside.

Features of Single-Row Cylindrical Roller Bearings

Cage Spec.	Material	Steel	Steel	Polyamide 66 resin	L-PPS resin	Brass	
		Pressed		Molded		Machined	
Designation		W	EW	ET	ET7	M	EM
High Load Capacity		○	◎	◎	◎	△	◎
High-Speed		△	○	○	○	○	◎
High-Temperature		○	○	△	○	○	○
Vibration		×	×	×	×	△	○

◎ Excellent ○ Good △ Fair × Poor

If a cage is nonstandard for a given bearing number the number of rollers may vary; in such a case, the load rating will differ from that listed in the bearing tables.

Many NN double-row bearings have tapered bores, and they are primarily used in the main spindles of machine tools. Cages are made of either molded polyphenylenesulfide (PPS) or machined brass.

Formulation of Bearing Designations

Single-Row Cylindrical Roller Bearing

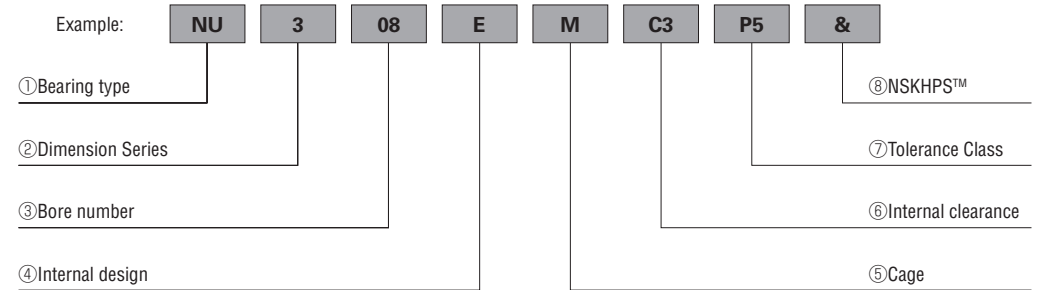

- ① Bearing type: NU : Single-row cylindrical roller bearings (Outer ring with both ribs + Inner ring without rib)
Please refer to page C124 for detailed information.
- ② Dimension Series: 10 : 10 Series, 2: 02 Series, 22 : 22 Series, 3 : 03 Series, 23 : 23 Series, 4 : 04 Series,
- ③ Bore number: Less than 03, Bearing bore 01 : 12mm, 02 : 15mm, 03 : 17mm
Over 04, Bearing bore Bore number X 5 (mm)
- ④ Internal design: E : High load capacity
- ⑤ Cage: W : Pressed-steel Cage, M : Machined Brass Cage, No designation : Machined-brass cage (in Series 10)
T : Polyamide 66 resin cage, T7 : L-PPS resin cage
- ⑥ Internal clearance: For All Radial Brgs.
Omitted : CN clearance, C3 : Clearance greater than CN, C4 : Clearance greater than C3, CG : Special Clearance
For Non-Interchangeable Cylindrical Roller Bearings
CC : Normal Clearance, CC3 : Clearance greater than CC, CC4 : Clearance greater than CC3, CCG : Special Clearance
- ⑦ Tolerance class: Omitted : ISO Normal, P6 : ISO Class 6,
P5 : ISO Class 5, P4 : ISO Class 4
- ⑧ NSKHPS™: & : NSKHPS™ Designation
Tolerance Class : ISO Normal

NSKHPS™ Cylindrical Roller Bearings

Features

Compared with conventional bearings ...

- Maximum Bearing Life **60% longer**
- New Product **Wide product lineup**

- Improved reliability
Up to 60% longer life than that of conventional bearings by optimization of the bearing's internal design and improvement of processing technology.
- Wide product lineup
NSK offers a wide lineup of NSKHPS bearings with four types of cages for wide range of sizes, offering a high degree of versatility for various general-purpose applications.
 - Pressed-steel cage with high cost performance
 - Highly reliable machined-brass cage
 - Polyamide-resin cage that excels in heat and chemical resistance

PRECAUTIONS FOR USE OF CYLINDRICAL ROLLER BEARINGS

If the load on cylindrical roller bearings becomes too small during operation, slippage occurs between the rollers and raceways, which may result in smearing. This tendency is prevalent especially with large bearings since the weight of the rollers and cage is high.

In case of strong shock loads or vibration, pressed-steel cages are sometimes inadequate.

If very small bearing loads, strong shock loads, or vibration are expected, please consult with NSK for selection of the bearings.

Bearings with molded polyamide cages (ET type) can be used continuously at temperatures between -40 and 120 °C. If the bearings are to be used in gear oil, nonflammable hydraulic oil, or ester oil at a temperature over 100 °C, please contact NSK beforehand.

TOLERANCES AND RUNNING ACCURACY

CYLINDRICAL ROLLER BEARINGS Table 7.2 (Pages A128 to A131)

NSKHPS CYLINDRICAL ROLLER BEARINGS

Tolerance for Dimensions : ISO Normal

Running Accuracy : ISO Normal

DOUBLE-ROW CYLINDRICAL ROLLER

BEARINGS Table 7.2 (Pages A128 to A131)

Table 2 Tolerances for Roller Inscribed Circle Diameter F_w and Roller Circumscribed Circle Diameter E_w of Cylindrical Roller Bearings With Interchangeable Rings

Units : m

Nominal Bore Diameter d (mm)		Tolerances for F_w of Types NU, NJ, NUP, NH, and NNU ΔF_w		Tolerances for E_w of Types N, NF, and NN ΔE_w	
over	incl.	high	low	high	low
—	20	+10	0	0	-10
20	50	+15	0	0	-15
50	120	+20	0	0	-20
120	200	+25	0	0	-25
200	250	+30	0	0	-30
250	315	+35	0	0	-35
315	400	+40	0	0	-40
400	500	+45	0	—	—

RECOMMENDED FITS

CYLINDRICAL ROLLER BEARINGS..... Table 8.3 (Page A164)

Table 8.5 (Page A165)

DOUBLE-ROW CYLINDRICAL ROLLER

BEARINGS Table 8.3 (Page A164)

Table 8.5 (Page A165)

INTERNAL CLEARANCES

CYLINDRICAL ROLLER BEARINGS..... Table 8.15 (Page A171)

NSKHPS CYLINDRICAL ROLLER BEARINGS

INTERNAL CLEARANCE DESIGNATION : CN, C3, C4

DOUBLE-ROW CYLINDRICAL ROLLER BEARINGS..... Table 8.15 (Page A171)

PERMISSIBLE MISALIGNMENT

The permissible misalignment of cylindrical roller bearings varies depending on the type and internal specifications, but under normal loads, the angles are approximately as follows:

Cylindrical roller bearings of Width Series 0 or 1 0.0012 radian (4')

Cylindrical roller bearings of Width Series 2 0.0006 radian (2')

For double-row cylindrical roller bearings, nearly no misalignment is allowed.

LIMITING SPEEDS (Mechanical)

In some single-row cylindrical roller bearings, optional cage types are available for special purposes or customer requests. The limiting speeds (mechanical) in the bearing tables reflect values for the standard cage type. Please consult with NSK regarding limiting speeds (mechanical) for optional cages.

LIMITING SPEEDS (Grease/Oil)

The limiting speeds (grease) and limiting speeds (oil) listed in the bearing tables should be adjusted depending on bearing load. Furthermore, higher speeds are attainable by making changes in the lubrication method, cage design, etc. Refer to Page A098 for more detailed information.

■ CYLINDRICAL ROLLER BEARINGS**TECHNICAL DATA****Free Space of Cylindrical Roller Bearings**

Cylindrical roller bearings often employ grease lubrication because it makes maintenance easier and simplifies the peripheral construction of the housing. Select a grease brand appropriate for the operating conditions while noting the grease fill amount and position of the bearing and housing.

Cylindrical roller bearings can be divided into types NU, NJ, N, NF, NH, and NUP according to the collar, collar ring, and position of the inner or outer ring ribs. Even if bearings belong to the same Dimension Series, they may have different amounts of free space depending on whether the cage

provided is made from pressed-steel or from machined high-tension brass. When determining the grease filling amount, please refer to Tables 1 and 2 for the free space of NU type bearings.

For other types, the free space can be determined from a free space ratio based on the NU type, as shown in Table 3. For example, the free space of an NJ310 bearing with a pressed steel cage may be calculated approximately as 47 cm³. This result was obtained by multiplying the free space of the bearing (52 cm³) in Table 1 by the space ratio 0.90 for the NJ type (Table 3).

Table 1 Free Space of Cylindrical Roller Bearings (NU Type) (1) (With Pressed Cage)

Units: cm³

Bearing Bore No.	Bearing Free Space			
	Bearing Series			
	NU2	NU3	NU22	NU23
05	6.6	11	7.8	16
06	9.6	17	12	24
07	14	22	18	35
08	18	31	22	44
09	20	42	23	62
10	23	52	26	80
11	30	68	35	102
12	37	85	45	130
13	44	107	57	156
14	51	124	62	179
15	58	155	70	226
16	71	177	85	260
17	85	210	104	300
18	103	244	134	365
19	132	283	164	415
20	151	335	200	540

Table 2 Free Space of Cylindrical Roller Bearings (NU Type) (2) (With High-Tension Brass Machined Cage)

Units: cm³

Bearing Bore No.	Bearing Free Space			
	Bearing Series			
	NU2	NU3	NU22	NU23
05	5.0	7.6	5.7	10
06	7.4	12	7.9	16
07	9.6	16	12	27
08	12	21	15	32
09	15	29	16	45
10	18	38	17	58
11	22	52	24	77
12	26	62	31	88
13	31	74	43	104
14	37	92	44	129
15	42	102	50	149
16	51	122	60	181
17	64	164	74	200
18	79	193	96	279
19	94	218	116	280
20	115	221	137	355

Table 3 Ratio of Free Space in Cylindrical Roller Bearing Types

NU Type	NJ Type	N Type	NF Type
1	0.90	1.05	0.95

■ SINGLE-ROW CYLINDRICAL ROLLER BEARINGS

Bore Diameter 20 – 30 mm

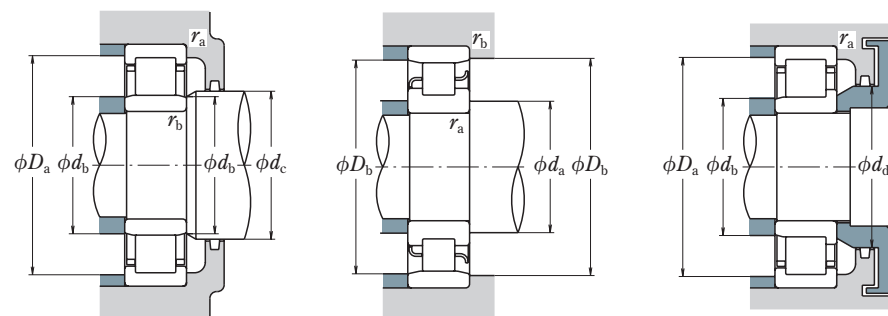
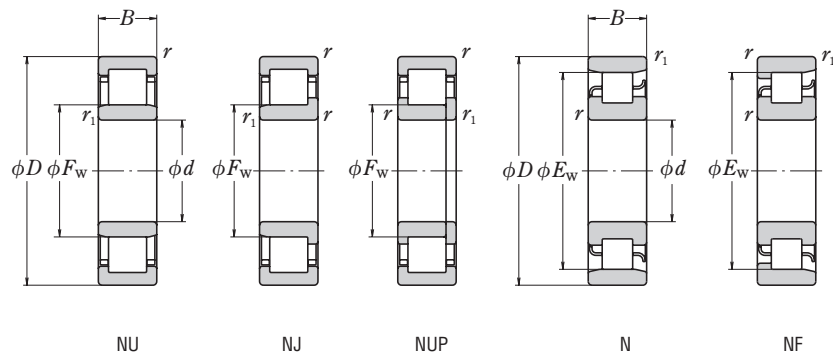

d	Boundary Dimensions (mm)						Basic Load Ratings (N)		Thermal Reference Speed	Speeds (min ⁻¹)		
	D	B	r min.	r ₁ min.	F _W	E _W	C _r	C _{0r}		Limiting Speeds		
										(⁵) Mechanical	Grease	
20	47	14	1	0.6	—	40	15 400	12 700	18 000	—	12 000	
	47	14	1	0.6	26.5	—	25 700	22 600	16 000	—	13 000	
	47	18	1	0.6	27	—	20 700	18 400	19 000	—	11 000	
	52	15	1.1	0.6	—	44.5	21 400	17 300	14 000	—	10 000	
	52	15	1.1	0.6	27.5	—	31 500	26 900	13 000	—	12 000	
	52	21	1.1	0.6	28.5	—	30 500	27 200	14 000	—	11 000	
	52	21	1.1	0.6	27.5	—	42 000	39 000	13 000	—	11 000	
	25	47	12	0.6	0.3	30.5	—	14 300	13 100	15 000	—	15 000
		52	15	1	0.6	—	45	17 700	15 700	16 000	—	10 000
		52	15	1	0.6	31.5	—	33 500	27 700	14 000	17 000	12 000
		52	15	1	0.6	31.5	—	29 300	27 700	14 000	17 000	12 000
		52	18	1	0.6	31.5	—	40 000	34 500	14 000	20 000	12 000
52		18	1	0.6	31.5	—	35 000	34 500	14 000	20 000	12 000	
62		17	1.1	1.1	—	53	29 300	25 200	12 000	—	8 000	
62		17	1.1	1.1	34	—	48 000	37 500	11 000	15 000	10 000	
62		17	1.1	1.1	34	—	41 500	37 500	11 000	15 000	10 000	
62		24	1.1	1.1	34	—	65 500	56 000	11 000	18 000	9 000	
62		24	1.1	1.1	34	—	57 000	56 000	11 000	18 000	9 000	
80		21	1.5	1.5	38.8	62.8	46 500	40 000	9 500	—	7 100	
30	55	13	1	0.6	36.5	48.5	19 700	19 600	13 000	—	12 000	
	62	16	1	0.6	—	53.5	24 900	23 300	13 000	—	8 500	
	62	16	1	0.6	37.5	—	45 000	37 500	12 000	14 000	9 500	
	62	16	1	0.6	37.5	—	39 000	37 500	12 000	14 000	9 500	
	62	20	1	0.6	37.5	—	56 500	50 000	12 000	17 000	9 500	
	62	20	1	0.6	37.5	—	49 000	50 000	12 000	17 000	9 500	
	72	19	1.1	1.1	—	62	38 500	35 000	10 000	—	7 100	
	72	19	1.1	1.1	40.5	—	61 000	50 000	9 500	13 000	8 500	
	72	19	1.1	1.1	40.5	—	53 000	50 000	9 500	13 000	8 500	
	72	27	1.1	1.1	40.5	—	86 000	77 500	9 500	16 000	8 000	
	72	27	1.1	1.1	40.5	—	74 500	77 500	9 500	16 000	8 000	
	90	23	1.5	1.5	45	73	62 500	55 000	8 500	—	6 000	

Notes (1) Cage designation (M) is usually omitted from the bearing designation.
 (2) When L-shaped thrust collars (see Pages C156-C157) are used, the bearings are considered the NH type.

Bearing Designations	Cage ⁽¹⁾ Standard Option	Abutment and Fillet Dimensions (mm)														Mass (kg) approx.			
		(2)		(3)		(4)		(5)		(6)		(7)		(8)					
		NU	NJ	NUP	N	NF	d _a ⁽³⁾ min.	d _b min.	d _b ⁽⁴⁾ max.	d _c min.	d _d min.	D _a ⁽³⁾ max.	D _b max.	D _b min.	r _a max.		r _b max.		
N 204	W	—	—	—	—	N NF	25	—	—	—	—	—	—	—	43	42	1	0.6	0.107
NU204E	T	T7	NU	NJ	NUP	—	25	24	25	29	32	42	—	—	—	—	1	0.6	0.107
NU2204	W	M	NU	NJ	—	—	25	24	25	29	32	42	—	—	—	—	1	0.6	0.144
N 304	W	—	—	—	—	N NF	26.5	—	—	—	—	—	—	—	48	46	1	0.6	0.148
NU304E	T	T7	NU	NJ	NUP	—	26.5	24	26	30	33	45.5	—	—	—	—	1	0.6	0.145
NU2304	M	—	NU	NJ	NUP	—	26.5	24	27	30	33	45.5	—	—	—	—	1	0.6	0.217
NU2304E	T7	—	NU	NJ	NUP	—	26.5	24	26	30	33	45.5	—	—	—	—	1	0.6	0.209
NU1005	(M)	—	NU	—	—	—	—	27	30	32	—	43	—	—	—	—	0.6	0.3	0.094
N 205	W	M	—	—	—	N NF	30	—	—	—	—	—	—	—	48	46	1	0.6	0.135
*NU205E	W	M, T, T7	NU	NJ	NUP	—	30	29	30	34	37	47	—	—	—	—	1	0.6	0.136
NU205E	W	M, T, T7	NU	NJ	NUP	—	30	29	30	34	37	47	—	—	—	—	1	0.6	0.136
*NU2205E	M	T, T7	NU	NJ	NUP	—	30	29	30	34	37	47	—	—	—	—	1	0.6	0.16
NU2205E	M	T, T7	NU	NJ	NUP	—	30	29	30	34	37	47	—	—	—	—	1	0.6	0.16
N 305	W	M	—	—	—	N NF	31.5	—	—	—	—	—	—	—	55.5	50	1	1	0.233
*NU305E	W	M, T, T7	NU	NJ	NUP	—	31.5	31.5	32	37	40	55.5	—	—	—	—	1	1	0.269
NU305E	W	M, T, T7	NU	NJ	NUP	—	31.5	31.5	32	37	40	55.5	—	—	—	—	1	1	0.269
*NU2305E	M	T, T7	NU	NJ	NUP	—	31.5	31.5	32	37	40	55.5	—	—	—	—	1	1	0.338
NU2305E	M	T, T7	NU	NJ	NUP	—	31.5	31.5	32	37	40	55.5	—	—	—	—	1	1	0.338
NU405	W	—	NU	NJ	—	N NF	33	33	37	41	46	72	72	64	1.5	1.5	—	—	0.57
NU1006	(M)	—	NU	—	—	N	35	34	36	38	—	50	51	49	1	0.5	—	—	0.136
N 206	W	M	—	—	—	N NF	35	—	—	—	—	—	—	—	58	56	1	0.6	0.208
*NU206E	W	M, T, T7	NU	NJ	NUP	—	35	34	36	40	44	57	—	—	—	—	1	0.6	0.205
NU206E	W	M, T, T7	NU	NJ	NUP	—	35	34	36	40	44	57	—	—	—	—	1	0.6	0.205
*NU2206E	M	T, T7	NU	NJ	NUP	—	35	34	36	40	44	57	—	—	—	—	1	0.6	0.255
NU2206E	M	T, T7	NU	NJ	NUP	—	35	34	36	40	44	57	—	—	—	—	1	0.6	0.255
N 306	W	M	—	—	—	N NF	36.5	—	—	—	—	—	—	—	65.5	64	1	1	0.353
*NU306E	W	M, T, T7	NU	NJ	NUP	—	36.5	36.5	39	44	48	65.5	—	—	—	—	1	1	0.409
NU306E	W	M, T, T7	NU	NJ	NUP	—	36.5	36.5	39	44	48	65.5	—	—	—	—	1	1	0.409
*NU2306E	M	T, T7	NU	NJ	NUP	—	36.5	36.5	39	44	48	65.5	—	—	—	—	1	1	0.518
NU2306E	M	T, T7	NU	NJ	NUP	—	36.5	36.5	39	44	48	65.5	—	—	—	—	1	1	0.518
NU406	W	M	NU	NJ	—	N NF	38	38	43	47	52	82	82	75	1.5	1.5	—	—	0.758

Notes (3) If axial loads are applied, increase d_a and reduce D_a from the values listed above.
 (4) d_b (max.) refers to values for adjusting rings for NU and NJ bearings.
 (5) The limiting speeds (mechanical) in the bearing tables are for standard cages.
Remark Bearings denoted by an asterisk (*) are NSKHPST™ cylindrical roller bearings.

■ SINGLE-ROW CYLINDRICAL ROLLER BEARINGS

Bore Diameter 35 – 40 mm

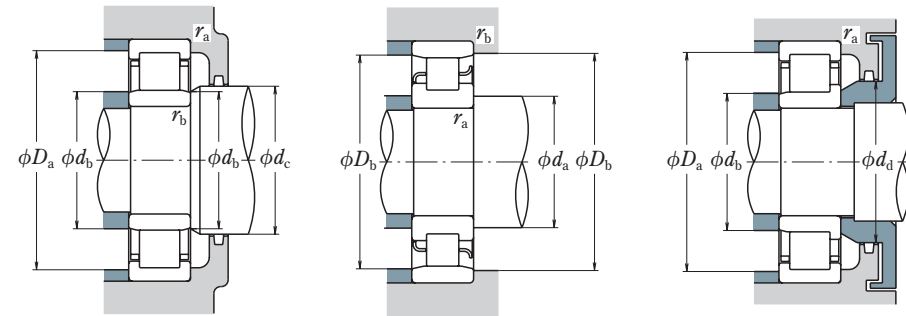
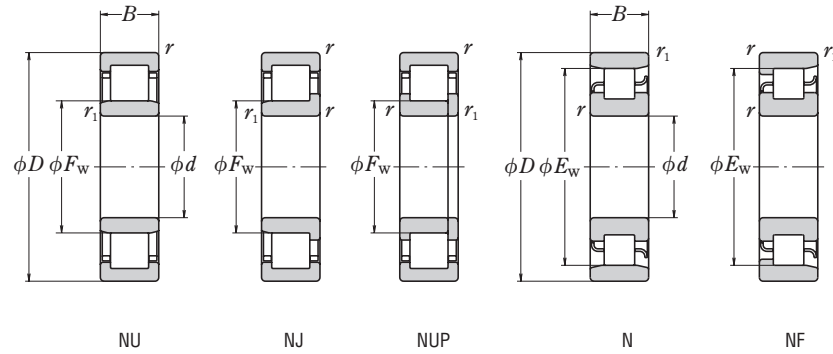

d	Boundary Dimensions (mm)						Basic Load Ratings (N)		Thermal Reference Speed	Speeds (min ⁻¹)	
	D	B	r	r ₁	F _w	E _w	C _r	C _{0r}		Limiting Speeds	
			min.	min.						(⁵) Mechanical	Grease
35	62	14	1	0.6	42	55	22 600	23 200	11 000	—	11 000
	72	17	1.1	0.6	—	61.8	35 500	34 000	11 000	—	7 500
	72	17	1.1	0.6	44	—	58 000	50 000	10 000	12 000	8 500
	72	17	1.1	0.6	44	—	50 500	50 000	10 000	12 000	8 500
	72	23	1.1	0.6	44	—	71 000	65 500	11 000	15 000	8 500
	72	23	1.1	0.6	44	—	61 500	65 500	11 000	15 000	8 500
	80	21	1.5	1.1	—	68.2	49 500	47 000	9 500	—	6 300
	80	21	1.5	1.1	46.2	—	76 500	65 500	8 500	11 000	7 500
	80	21	1.5	1.1	46.2	—	66 500	65 500	8 500	11 000	7 500
	80	31	1.5	1.1	46.2	—	107 000	101 000	9 000	14 000	6 700
80	31	1.5	1.1	46.2	—	93 000	101 000	9 000	14 000	6 700	
100	25	1.5	1.5	53	83	75 500	69 000	7 500	—	5 300	
40	68	15	1	0.6	47	61	27 300	29 000	10 000	—	10 000
	80	18	1.1	1.1	—	70	43 500	43 000	9 500	—	6 700
	80	18	1.1	1.1	49.5	—	64 000	55 500	9 000	11 000	7 500
	80	18	1.1	1.1	49.5	—	55 500	55 500	9 000	11 000	7 500
	80	23	1.1	1.1	49.5	—	83 000	77 500	9 000	13 000	7 500
	80	23	1.1	1.1	49.5	—	72 500	77 500	9 000	13 000	7 500
	90	23	1.5	1.5	—	77.5	58 500	57 000	8 500	—	5 600
	90	23	1.5	1.5	52	—	95 500	81 500	7 500	10 000	6 700
	90	23	1.5	1.5	52	—	83 000	81 500	7 500	10 000	6 700
	90	33	1.5	1.5	52	—	131 000	122 000	8 000	12 000	6 000
90	33	1.5	1.5	52	—	114 000	122 000	8 000	12 000	6 000	
110	27	2	2	58	92	95 500	89 000	6 700	—	4 800	

Bearing Designations	Abutment and Fillet Dimensions (mm)										Mass (kg)		
	Cage ⁽¹⁾		NU		NJ		NUP		N			NF	
	Standard	Option	d _a ⁽²⁾ min.	d _b min.	d _b ⁽⁴⁾ max.	d _c min.	d _d min.	D _a ⁽³⁾ max.	D _b max.	D _b min.		r _a max.	r _b max.
NU1007	(M)	—	40	39	41	44	—	57	58	56	1	0.5	
N 207	W	M	41.5	—	—	—	—	68	64	1	0.6		
*NU207E	W	M, T, T7	41.5	39	42	46	50	65.5	—	—	1	0.6	
NU207E	W	M, T, T7	41.5	39	42	46	50	65.5	—	—	1	0.6	
*NU2207E	M	T, T7	41.5	39	42	46	50	65.5	—	—	1	0.6	
NU2207E	M	T, T7	41.5	39	42	46	50	65.5	—	—	1	0.6	
N 307	W	M	43	—	—	—	—	73.5	70	1.5	1		
*NU307E	W	M, T, T7	41.5	41.5	44	48	53	72	—	—	1.5	1	
NU307E	W	M, T, T7	41.5	41.5	44	48	53	72	—	—	1.5	1	
*NU2307E	M	T, T7	43	41.5	44	48	53	72	—	—	1.5	1	
NU2307E	M	T, T7	43	41.5	44	48	53	72	—	—	1.5	1	
NU407	W	—	43	43	51	55	61	92	92	85	1.5	1.5	
NU1008	(M)	—	45	44	46	49	—	63	64	62	1	0.6	
N 208	W	M	46.5	—	—	—	—	73.5	72	1	1		
*NU208E	W	M, T, T7	46.5	46.5	48	52	56	73.5	—	—	1	1	
NU208E	W	M, T, T7	46.5	46.5	48	52	56	73.5	—	—	1	1	
*NU2208E	M	T, T7	46.5	46.5	48	52	56	73.5	—	—	1	1	
NU2208E	M	T, T7	46.5	46.5	48	52	56	73.5	—	—	1	1	
N 308	W	M	48	—	—	—	—	82	79	1.5	1.5		
*NU308E	W	M, T, T7	48	48	50	55	60	82	—	—	1.5	1.5	
NU308E	W	M, T, T7	48	48	50	55	60	82	—	—	1.5	1.5	
*NU2308E	M	T, T7	48	48	50	55	60	82	—	—	1.5	1.5	
NU2308E	M	T, T7	48	48	50	55	60	82	—	—	1.5	1.5	
NU408	W	—	49	49	56	60	67	101	101	94	2	2	

Notes (1) Cage designation (M) is usually omitted from the bearing designation.
 (2) When L-shaped thrust collars (see Pages C156-C157) are used, the bearings are considered the NH type.

Notes (3) If axial loads are applied, increase d_a and reduce D_a from the values listed above.
 (4) d_b (max.) refers to values for adjusting rings for NU and NJ bearings.
 (5) The limiting speeds (mechanical) in the bearing tables are for standard cages.
 Remark Bearings denoted by an asterisk (*) are NSKHPS™ cylindrical roller bearings.

■ SINGLE-ROW CYLINDRICAL ROLLER BEARINGS

Bore Diameter 45 – 50 mm

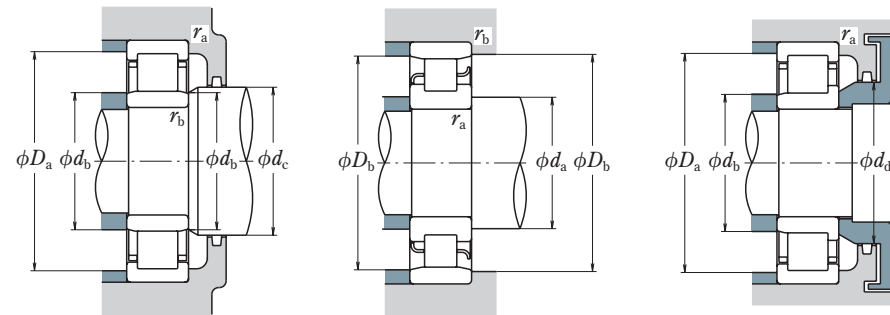
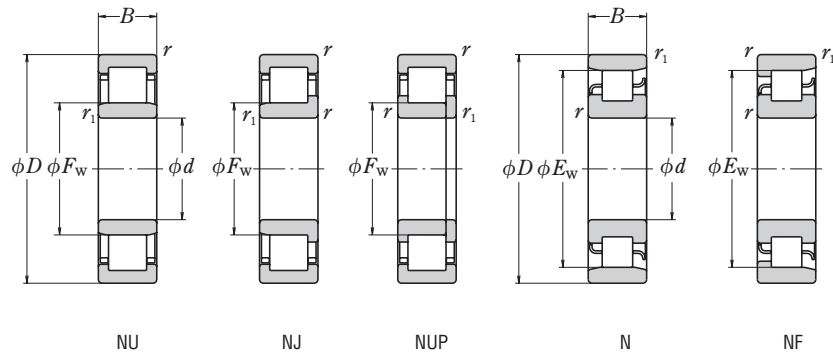

d	Boundary Dimensions (mm)						Basic Load Ratings (N)		Thermal Reference Speed	Speeds (min ⁻¹)	
	D	B	r	r ₁	F _w	E _w	C _r	C _{0r}		Limiting Speeds	
			min.	min.						(⁵) Mechanical	Grease
45	75	16	1	0.6	52.5	67.5	32 500	35 500	9 500	—	9 000
	85	19	1.1	1.1	—	75	46 000	47 000	9 000	—	6 300
	85	19	1.1	1.1	54.5	—	72 500	66 500	8 500	10 000	6 700
	85	19	1.1	1.1	54.5	—	63 000	66 500	8 500	10 000	6 700
	85	23	1.1	1.1	54.5	—	87 500	84 500	8 500	12 000	6 700
	85	23	1.1	1.1	54.5	—	76 000	84 500	8 500	12 000	6 700
	100	25	1.5	1.5	—	86.5	79 000	77 500	7 500	—	5 000
	100	25	1.5	1.5	58.5	—	112 000	98 500	7 100	9 000	6 000
	100	25	1.5	1.5	58.5	—	97 500	98 500	7 100	9 000	6 000
	100	36	1.5	1.5	58.5	—	158 000	153 000	7 100	11 000	5 300
	100	36	1.5	1.5	58.5	—	137 000	153 000	7 100	11 000	5 300
	120	29	2	2	64.5	100.5	107 000	102 000	6 300	—	4 300
50	80	16	1	0.6	57.5	72.5	32 000	36 000	8 500	—	8 000
	90	20	1.1	1.1	—	80.4	48 000	51 000	8 500	—	5 600
	90	20	1.1	1.1	59.5	—	79 500	76 500	8 000	9 000	6 300
	90	20	1.1	1.1	59.5	—	69 000	76 500	8 000	9 000	6 300
	90	23	1.1	1.1	59.5	—	96 000	97 000	7 500	11 000	6 300
	90	23	1.1	1.1	59.5	—	83 500	97 000	7 500	11 000	6 300
	110	27	2	2	—	95	87 000	86 000	7 100	—	4 500
	110	27	2	2	65	—	127 000	113 000	6 700	8 000	5 000
	110	27	2	2	65	—	110 000	113 000	6 700	8 000	5 000
	110	40	2	2	65	—	187 000	187 000	6 700	10 000	5 000
	110	40	2	2	65	—	163 000	187 000	6 700	10 000	5 000
	130	31	2.1	2.1	—	110.8	139 000	136 000	5 600	—	4 000
130	31	2.1	2.1	70.8	—	129 000	124 000	5 600	—	4 000	

Notes (1) Cage designation (M) is usually omitted from the bearing designation.
 (2) When L-shaped thrust collars (see Pages C156-C157) are used, the bearings are considered the NH type.

Bearing Designations	Abutment and Fillet Dimensions (mm)										Mass (kg)						
	Cage ⁽¹⁾		⁽²⁾		⁽³⁾		⁽⁴⁾		⁽⁵⁾			approx.					
	Standard Option	NU	NJ	NUP	N	NF	d _a min.	d _b min.	d _b max.	d _c min.			d _d min.	D _a max.	D _b max.	D _b min.	r _a max.
NU1009	(M)	—	NU	—	—	N NF	50	49	51	54	—	70	71	68	1	0.6	0.279
N 209	W	M	—	—	—	N NF	51.5	—	—	—	—	—	78.5	77	1	1	0.429
*NU209E	W	M, T, T7	NU	NJ	NUP	—	51.5	51.5	52	57	61	78.5	—	—	1	1	0.438
NU209E	W	M, T, T7	NU	NJ	NUP	—	51.5	51.5	52	57	61	78.5	—	—	1	1	0.438
*NU2209E	M	T, T7	NU	NJ	NUP	—	51.5	51.5	52	57	61	78.5	—	—	1	1	0.521
NU2209E	M	T, T7	NU	NJ	NUP	—	51.5	51.5	52	57	61	78.5	—	—	1	1	0.521
N 309	W	M	—	—	—	N NF	53	—	—	—	—	—	92	77	1.5	1.5	0.869
*NU309E	W	M, T, T7	NU	NJ	NUP	—	53	53	56	60	66	92	—	—	1.5	1.5	1.01
NU309E	W	M, T, T7	NU	NJ	NUP	—	53	53	56	60	66	92	—	—	1.5	1.5	1.01
*NU2309E	M	T, T7	NU	NJ	NUP	—	53	53	56	60	66	92	—	—	1.5	1.5	1.28
NU2309E	M	T, T7	NU	NJ	NUP	—	53	53	56	60	66	92	—	—	1.5	1.5	1.28
NU409	W	—	NU	NJ	NUP	N NF	54	54	62	66	74	111	111	103	2	2	1.62
NU1010	(M)	—	NU	NJ	NUP	N	55	54	56	59	—	75	76	73	1	0.6	0.301
N 210	W	M	—	—	—	N NF	56.5	—	—	—	—	—	83.5	82	1	1	0.483
*NU210E	W	M, T, T7	NU	NJ	NUP	—	56.5	56.5	57	62	67	83.5	—	—	1	1	0.50
NU210E	W	M, T, T7	NU	NJ	NUP	—	56.5	56.5	57	62	67	83.5	—	—	1	1	0.50
*NU2210E	M	T, T7	NU	NJ	NUP	—	56.5	56.5	57	62	67	83.5	—	—	1	1	0.562
NU2210E	M	T, T7	NU	NJ	NUP	—	56.5	56.5	57	62	67	83.5	—	—	1	1	0.562
N 310	W	M	—	—	—	N NF	59	—	—	—	—	—	101	97	2	2	1.11
*NU310E	W	M, T, T7	NU	NJ	NUP	—	59	59	63	67	73	101	—	—	2	2	1.3
NU310E	W	M, T, T7	NU	NJ	NUP	—	59	59	63	67	73	101	—	—	2	2	1.3
*NU2310E	M	T, T7	NU	NJ	NUP	—	59	59	63	67	73	101	—	—	2	2	1.7
NU2310E	M	T, T7	NU	NJ	NUP	—	59	59	63	67	73	101	—	—	2	2	1.7
N 410	W	M	—	—	—	N NF	65	—	—	—	—	—	117	113	2	2	2
NU410	W	M	NU	NJ	NUP	—	61	61	68	73	81	119	119	113.3	2	2	1.99

Notes (3) If axial loads are applied, increase d_a and reduce D_a from the values listed above.
 (4) d_b (max.) refers to values for adjusting rings for NU and NJ bearings.
 (5) The limiting speeds (mechanical) in the bearing tables are for standard cages.
Remark Bearings denoted by an asterisk (*) are NSKHPS™ cylindrical roller bearings.

■ SINGLE-ROW CYLINDRICAL ROLLER BEARINGS

Bore Diameter 55 – 60 mm

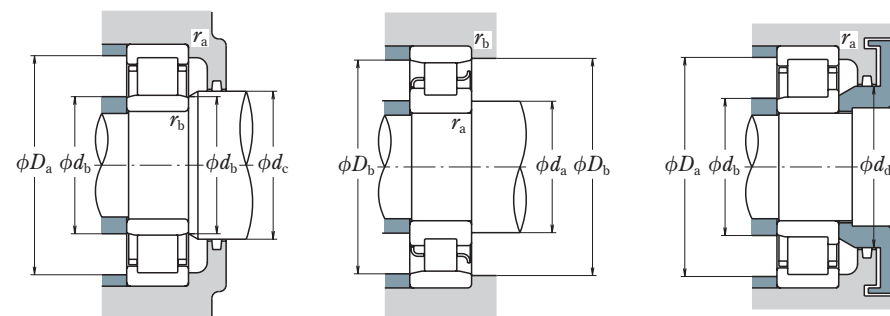
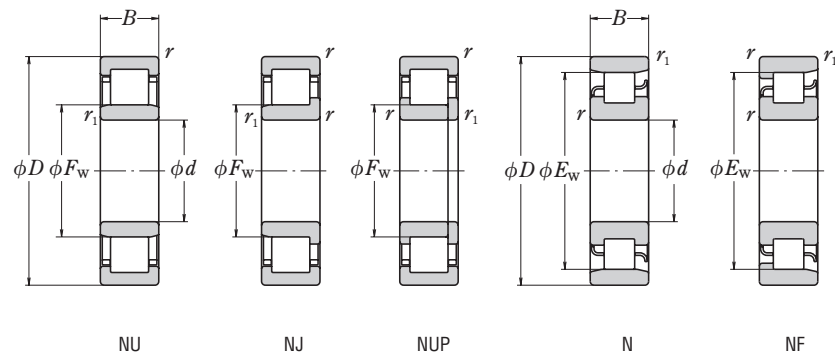

d	Boundary Dimensions (mm)						Basic Load Ratings (N)		Thermal Reference Speed	Speeds (min ⁻¹)	
	D	B	r	r ₁	F _w	E _w	C _r	C _{0r}		Limiting Speeds	
			min.	min.						(⁵) Mechanical	Grease
55	90	18	1.1	1	64.5	80.5	37 500	44 000	8 000	—	7 500
	100	21	1.5	1.1	—	88.5	58 000	62 500	7 500	—	5 300
	100	21	1.5	1.1	66	—	99 000	98 500	6 700	8 500	5 600
	100	21	1.5	1.1	66	—	86 500	98 500	6 700	8 500	5 600
	100	25	1.5	1.1	66	—	117 000	122 000	6 700	10 000	5 600
	100	25	1.5	1.1	66	—	101 000	122 000	6 700	10 000	5 600
	120	29	2	2	—	104.5	111 000	111 000	6 300	—	4 000
	120	29	2	2	70.5	—	158 000	143 000	6 000	7 500	4 500
	120	29	2	2	70.5	—	137 000	143 000	6 000	7 500	4 500
	120	43	2	2	70.5	—	231 000	233 000	6 000	9 000	4 500
	120	43	2	2	70.5	—	201 000	233 000	6 000	9 000	4 500
	140	33	2.1	2.1	77.2	117.2	139 000	138 000	5 300	—	3 800
60	95	18	1.1	1	69.5	85.5	40 000	48 500	7 500	—	6 700
	110	22	1.5	1.5	—	97.5	68 500	75 000	7 100	—	4 800
	110	22	1.5	1.5	72	—	112 000	107 000	6 300	7 500	5 300
	110	22	1.5	1.5	72	—	97 500	107 000	6 300	7 500	5 300
	110	28	1.5	1.5	72	—	151 000	157 000	6 300	9 500	5 300
	110	28	1.5	1.5	72	—	131 000	157 000	6 300	9 500	5 300
	130	31	2.1	2.1	—	113	124 000	126 000	6 000	—	3 800
	130	31	2.1	2.1	77	—	124 000	126 000	6 000	—	3 800
	130	31	2.1	2.1	77	—	169 000	157 000	5 600	9 500	4 800
	130	31	2.1	2.1	77	—	150 000	157 000	5 600	9 500	4 800
	130	46	2.1	2.1	77	—	251 000	262 000	5 600	8 500	4 300
	130	46	2.1	2.1	77	—	222 000	262 000	5 600	8 500	4 300
150	35	2.1	2.1	83	127	167 000	168 000	5 000	—	3 400	

Bearing Designations	Abutment and Fillet Dimensions (mm)												Mass (kg)				
	Cage ⁽¹⁾		⁽²⁾		⁽³⁾		⁽⁴⁾		⁽³⁾		⁽³⁾			approx.			
	Standard Option	NU	NJ	NUP	N	NF	d _a min.	d _b min.	d _b max.	d _c min.	d _d min.	D _a max.			D _b max.	D _b min.	r _a max.
NU1011	(M)	—	NU	NJ	—	N	61.5	60	63	66	—	83.5	85		82	1	1
N 211	W	M	—	—	—	N	63	—	—	—	—	—	93.5	91	1.5	1	0.634
*NU211E	W	M, T, T7	NU	NJ	NUP	—	63	61.5	64	68	73	92	—	—	1.5	1	0.669
NU211E	W	M, T, T7	NU	NJ	NUP	—	63	61.5	64	68	73	92	—	—	1.5	1	0.669
*NU2211E	M	T, T7	NU	NJ	NUP	—	63	61.5	64	68	73	92	—	—	1.5	1	0.783
NU2211E	M	T, T7	NU	NJ	NUP	—	63	61.5	64	68	73	92	—	—	1.5	1	0.783
N 311	W	M	—	—	—	N	64	—	—	—	—	—	111	107	2	2	1.42
*NU311E	W	M, T, T7	NU	NJ	NUP	—	64	64	68	72	80	111	—	—	2	2	1.64
NU311E	W	M, T, T7	NU	NJ	NUP	—	64	64	68	72	80	111	—	—	2	2	1.64
*NU2311E	M	T, T7	NU	NJ	NUP	—	64	64	68	72	80	111	—	—	2	2	2.18
NU2311E	M	T, T7	NU	NJ	NUP	—	64	64	68	72	80	111	—	—	2	2	2.18
NU411	W	—	NU	NJ	NUP	N	66	66	75	79	87	129	129	119	2	2	2.5
NU1012	(M)	—	NU	NJ	—	N	66.5	65	68	71	—	88.5	90	87	1	1	0.474
N 212	W	M	—	—	—	N	68	—	—	—	—	—	102	100	1.5	1.5	0.823
*NU212E	W	M, T, T7	NU	NJ	NUP	—	68	68	70	75	80	102	—	—	1.5	1.5	0.824
NU212E	W	M, T, T7	NU	NJ	NUP	—	68	68	70	75	80	102	—	—	1.5	1.5	0.824
*NU2212E	M	T, T7	NU	NJ	NUP	—	68	68	70	75	80	102	—	—	1.5	1.5	1.06
NU2212E	M	T, T7	NU	NJ	NUP	—	68	68	70	75	80	102	—	—	1.5	1.5	1.06
N 312	W	M	—	—	—	N	71	—	—	—	—	—	119	115	2	2	1.78
NU312	W	M	NU	NJ	NUP	—	71	71	75	79	86	119	—	—	2	2	1.82
*NU312E	M	T, T7	NU	NJ	NUP	—	71	71	75	79	86	119	—	—	2	2	2.06
NU312E	M	T, T7	NU	NJ	NUP	—	71	71	75	79	86	119	—	—	2	2	2.06
*NU2312E	M	T, T7	NU	NJ	NUP	—	71	71	75	79	86	119	—	—	2	2	2.7
NU2312E	M	T, T7	NU	NJ	NUP	—	71	71	75	79	86	119	—	—	2	2	2.7
NU412	W	M	NU	NJ	NUP	N	71	71	80	85	94	139	139	130	2	2	3.04

Notes (1) Cage designation (M) is usually omitted from the bearing designation.
 (2) When L-shaped thrust collars (see Pages C156-C157) are used, the bearings are considered the NH type.

Notes (3) If axial loads are applied, increase d_a and reduce D_a from the values listed above.
 (4) d_b (max.) refers to values for adjusting rings for NU and NJ bearings.
 (5) The limiting speeds (mechanical) in the bearing tables are for standard cages.
Remark Bearings denoted by an asterisk (*) are NSKHPS™ cylindrical roller bearings.

■ SINGLE-ROW CYLINDRICAL ROLLER BEARINGS

Bore Diameter 65 – 70 mm

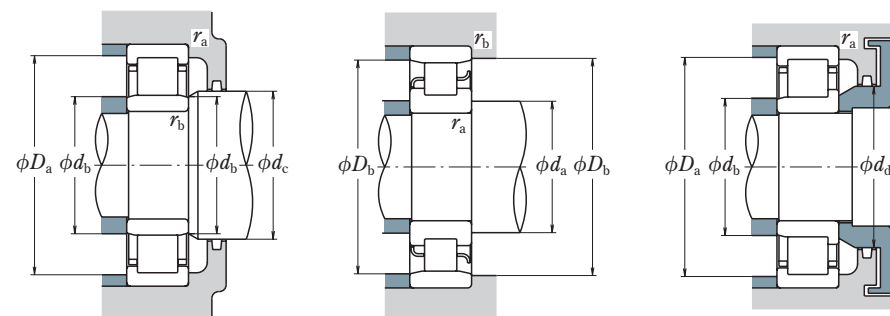
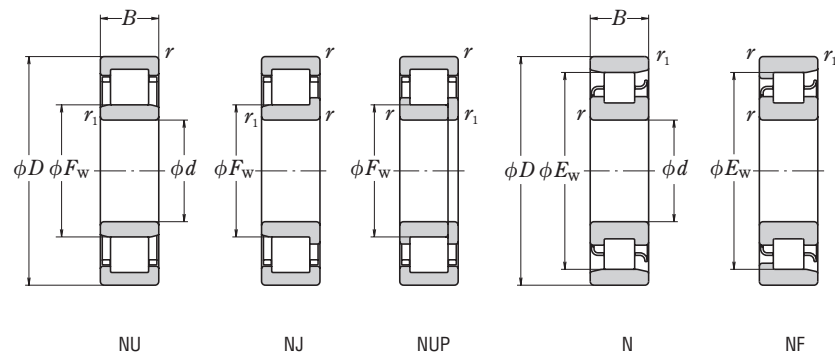

d	Boundary Dimensions (mm)						Basic Load Ratings (N)		Thermal Reference Speed	Speeds (min ⁻¹)	
	D	B	r min.	r ₁ min.	F _w	E _w	C _r	C _{0r}		Limiting Speeds	
										(⁵) Mechanical	Grease
65	100	18	1.1	1	74.5	90.5	41 000	51 000	6 700	—	6 300
	120	23	1.5	1.5	—	105.6	84 000	94 500	6 300	—	4 300
	120	23	1.5	1.5	78.5	—	124 000	119 000	6 000	7 100	4 800
	120	23	1.5	1.5	78.5	—	108 000	119 000	6 000	7 100	4 800
	120	31	1.5	1.5	78.5	—	171 000	181 000	6 000	8 500	4 800
	120	31	1.5	1.5	78.5	—	149 000	181 000	6 000	8 500	4 800
	140	33	2.1	2.1	—	121.5	135 000	139 000	5 600	—	3 600
	140	33	2.1	2.1	83.5	—	135 000	139 000	5 600	—	3 600
	140	33	2.1	2.1	82.5	—	204 000	191 000	5 300	8 500	4 300
	140	33	2.1	2.1	82.5	—	181 000	191 000	5 300	8 500	4 300
	140	48	2.1	2.1	82.5	—	263 000	265 000	5 600	7 500	3 800
	140	48	2.1	2.1	82.5	—	233 000	265 000	5 600	7 500	3 800
70	160	37	2.1	2.1	—	135.3	195 000	203 000	4 500	—	4 000
	160	37	2.1	2.1	89.3	—	182 000	186 000	4 800	—	3 200
	110	20	1.1	1	80	100	58 500	70 500	6 300	—	6 000
	125	24	1.5	1.5	—	110.5	83 500	95 000	6 300	—	4 000
	125	24	1.5	1.5	83.5	—	136 000	137 000	5 600	9 000	5 000
	125	24	1.5	1.5	83.5	—	119 000	137 000	5 600	9 000	5 000
	125	31	1.5	1.5	83.5	—	179 000	194 000	5 600	8 000	4 500
	125	31	1.5	1.5	83.5	—	156 000	194 000	5 600	8 000	4 500
	150	35	2.1	2.1	—	130	149 000	156 000	5 600	—	3 200
	150	35	2.1	2.1	90	—	158 000	168 000	5 300	—	3 200
	150	35	2.1	2.1	89	—	231 000	222 000	4 800	8 000	4 000
	150	35	2.1	2.1	89	—	205 000	222 000	4 800	8 000	4 000
	150	51	2.1	2.1	89	—	310 000	325 000	5 000	7 100	3 600
	150	51	2.1	2.1	89	—	274 000	325 000	5 000	7 100	3 600
	180	42	3	3	100	152	228 000	236 000	4 500	—	2 800

Bearing Designations	Abutment and Fillet Dimensions (mm)												Mass (kg) approx.					
	Cage ⁽¹⁾ Standard Option	Cage ⁽²⁾					d _a ⁽³⁾ min.	d _b min.	d _b ⁽⁴⁾ max.	d _c min.	d _d min.	D _a ⁽³⁾ max.		D _b max.	D _b min.	r _a max.	r _b max.	
		NU	NJ	NUP	N	NF												
NU1013	(M)	—	NU	NJ	—	N	NF	71.5	70	73	76	—	93.5	95	92	1	1	0.504
N 213	W	M	—	—	—	N	NF	73	—	—	—	—	112	108	1.5	1.5	1.05	
*NU213E	W	M, T, T7	NU	NJ	NUP	—	—	73	73	76	81	87	112	—	—	1.5	1.5	1.05
NU213E	W	M, T, T7	NU	NJ	NUP	—	—	73	73	76	81	87	112	—	—	1.5	1.5	1.05
*NU2213E	M	T, T7	NU	NJ	NUP	—	—	73	73	76	81	87	112	—	—	1.5	1.5	1.41
NU2213E	M	T, T7	NU	NJ	NUP	—	—	73	73	76	81	87	112	—	—	1.5	1.5	1.41
N 313	W	M	—	—	—	N	NF	76	—	—	—	—	129	125	2	2	2.17	
NU313	W	M	NU	NJ	NUP	—	—	76	76	81	85	93	129	—	—	2	2	2.23
*NU313E	M	T, T7	NU	NJ	NUP	—	—	76	76	80	85	93	129	—	—	2	2	2.56
NU313E	M	T, T7	NU	NJ	NUP	—	—	76	76	80	85	93	129	—	—	2	2	2.56
*NU2313E	M	T, T7	NU	NJ	NUP	—	—	76	76	80	85	93	129	—	—	2	2	3.16
NU2313E	M	T, T7	NU	NJ	NUP	—	—	76	76	80	85	93	129	—	—	2	2	3.16
N 413	M	—	—	—	—	N	NF	76	—	—	—	—	149	138.8	2	2	3.63	
NU413	W	M	NU	NJ	—	—	—	76	76	86	91	100	149	—	—	2	2	3.63
NU1014	(M)	—	NU	NJ	NUP	N	NF	76.5	75	79	82	—	103.5	105	101	1	1	0.693
N 214	W	M	—	—	—	N	NF	78	—	—	—	—	117	113	1.5	1.5	1.14	
*NU214E	M	T, T7	NU	NJ	NUP	—	—	78	78	81	86	92	117	—	—	1.5	1.5	1.29
NU214E	M	T, T7	NU	NJ	NUP	—	—	78	78	81	86	92	117	—	—	1.5	1.5	1.29
*NU2214E	M	T, T7	NU	NJ	NUP	—	—	78	78	81	86	92	117	—	—	1.5	1.5	1.49
NU2214E	M	T, T7	NU	NJ	NUP	—	—	78	78	81	86	92	117	—	—	1.5	1.5	1.49
N 314	W	M	—	—	—	N	NF	81	—	—	—	—	139	133.5	2	2	2.67	
NU314	W	M	NU	NJ	NUP	—	—	81	81	87	92	100	139	—	—	2	2	2.75
*NU314E	M	T, T7	NU	NJ	NUP	—	—	81	81	86	92	100	139	—	—	2	2	3.09
NU314E	M	T, T7	NU	NJ	NUP	—	—	81	81	86	92	100	139	—	—	2	2	3.09
*NU2314E	M	T, T7	NU	NJ	NUP	—	—	81	81	86	92	100	139	—	—	2	2	3.92
NU2314E	M	T, T7	NU	NJ	NUP	—	—	81	81	86	92	100	139	—	—	2	2	3.92
NU414	W	M	NU	NJ	NUP	N	NF	83	83	97	102	112	167	167	155	2.5	2.5	5.28

Notes (1) Cage designation (M) is usually omitted from the bearing designation.
 (2) When L-shaped thrust collars (see Pages C156-C157) are used, the bearings are considered the NH type.

Notes (3) If axial loads are applied, increase d_a and reduce D_a from the values listed above.
 (4) d_b (max.) refers to values for adjusting rings for NU and NJ bearings.
 (5) The limiting speeds (mechanical) in the bearing tables are for standard cages.

Remark Bearings denoted by an asterisk (*) are NSKHPS™ cylindrical roller bearings.

■ SINGLE-ROW CYLINDRICAL ROLLER BEARINGS

Bore Diameter 75 mm

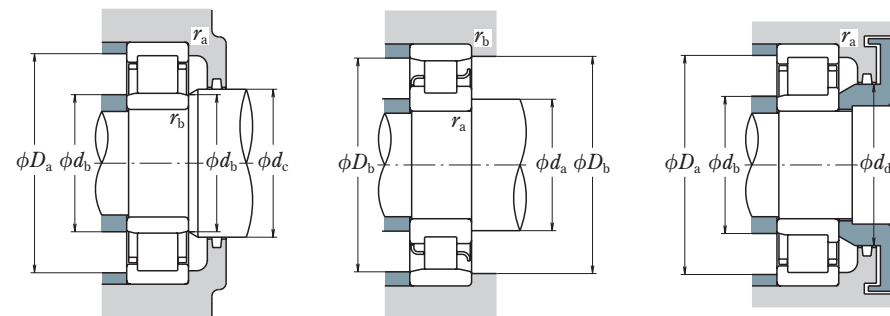
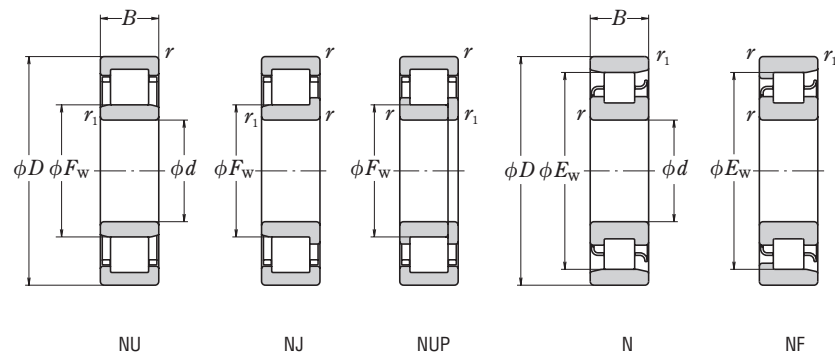

d	Boundary Dimensions (mm)						Basic Load Ratings (N)		Thermal Reference Speed	Speeds (min ⁻¹)	
	D	B	r	r ₁	F _w	E _w	C _r	C _{0r}		Limiting Speeds	
			min.	min.						(⁵) Mechanical	Grease
75	115	20	1.1	1	85	105	60 000	74 500	6 000	—	5 600
	130	25	1.5	1.5	—	116.5	96 500	111 000	6 000	—	3 800
	130	25	1.5	1.5	88.5	—	150 000	156 000	5 300	8 500	4 800
	130	25	1.5	1.5	88.5	—	130 000	156 000	5 300	8 500	4 800
	130	31	1.5	1.5	88.5	—	186 000	207 000	5 300	7 500	4 300
	130	31	1.5	1.5	88.5	—	162 000	207 000	5 300	7 500	4 300
	160	37	2.1	2.1	—	139.5	179 000	189 000	5 000	—	3 000
	160	37	2.1	2.1	95.5	—	179 000	189 000	5 000	—	3 000
	160	37	2.1	2.1	95	—	271 000	263 000	4 500	7 500	3 800
	160	37	2.1	2.1	95	—	240 000	263 000	4 500	7 500	3 800
160	55	2.1	2.1	95	—	370 000	395 000	4 800	6 700	3 400	
	55	2.1	2.1	95	—	330 000	395 000	4 800	6 700	3 400	
	45	3	3	104.5	160.5	262 000	274 000	4 300	—	2 600	

Notes (1) Cage designation (M) is usually omitted from the bearing designation.
 (2) When L-shaped thrust collars (see Pages C156-C157) are used, the bearings are considered the NH type.

Bearing Designations	Abutment and Fillet Dimensions (mm)														Mass (kg) approx.		
	Cage ⁽¹⁾		⁽²⁾		d _a ⁽³⁾ min.	d _b min.	d _b ⁽⁴⁾ max.	d _c min.	d _d min.	D _a ⁽³⁾ max.	D _b max.	D _b min.	r _a max.	r _b max.			
	Standard Option	NU	NJ	NUP												N	NF
NU1015	(M)	—	NU	—	N	NF	81.5	80	83	87	—	108.5	110	106	1	1	0.731
N 215	W	M	—	—	N	NF	83	—	—	—	—	122	119	1.5	1.5	1.23	
*NU215E	M	T, T7	NU	NJ	NUP	—	83	83	86	90	96	122	—	—	1.5	1.5	1.44
NU215E	M	T, T7	NU	NJ	NUP	—	83	83	86	90	96	122	—	—	1.5	1.5	1.44
*NU2215E	M	T, T7	NU	NJ	NUP	—	83	83	86	90	96	122	—	—	1.5	1.5	1.57
NU2215E	M	T, T7	NU	NJ	NUP	—	83	83	86	90	96	122	—	—	1.5	1.5	1.57
N 315	W	M	—	—	N	NF	86	—	—	—	—	149	143	2	2	3.2	
NU315	W	M	NU	NJ	NUP	—	86	86	93	97	106	149	—	—	2	2	3.26
*NU315E	M	T, T7	NU	NJ	NUP	—	86	86	92	97	106	149	—	—	2	2	3.73
NU315E	M	T, T7	NU	NJ	NUP	—	86	86	92	97	106	149	—	—	2	2	3.73
*NU2315E	M	T, T7	NU	NJ	NUP	—	86	86	92	97	106	149	—	—	2	2	4.86
NU2315E	M	T, T7	NU	NJ	NUP	—	86	86	92	97	106	149	—	—	2	2	4.86
NU415	W	M	NU	NJ	—	N	NF	88	88	102	107	118	177	164	2.5	2.5	6.27

Notes (3) If axial loads are applied, increase d_a and reduce D_a from the values listed above.
 (4) d_b (max.) refers to values for adjusting rings for NU and NJ bearings.
 (5) The limiting speeds (mechanical) in the bearing tables are for standard cages.
Remark Bearings denoted by an asterisk (*) are NSKHPS™ cylindrical roller bearings.

SINGLE-ROW CYLINDRICAL ROLLER BEARINGS

Bore Diameter 80 – 90 mm

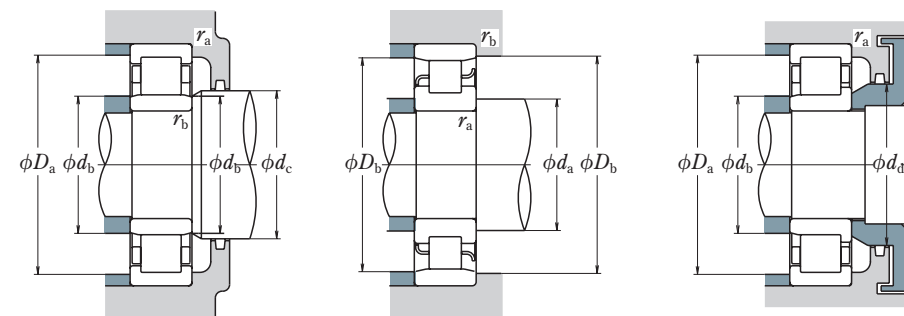
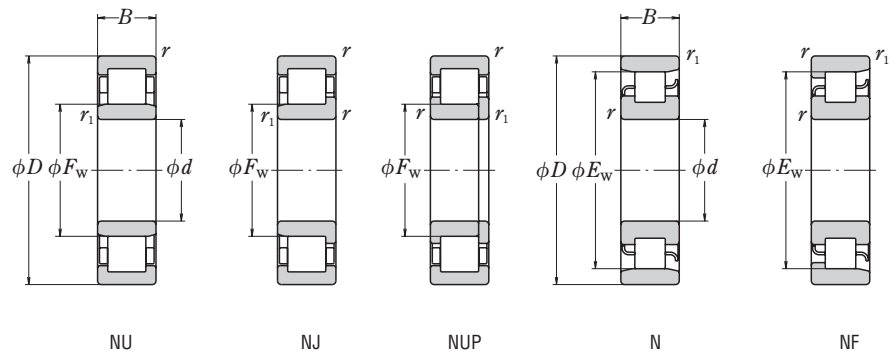

d	Boundary Dimensions (mm)						Basic Load Ratings (N)		Thermal Reference Speed	Speeds (min ⁻¹)	
	D	B	r min.	r ₁ min.	F _W	E _W	C _r	C _{0r}		Limiting Speeds	
										(⁵) Mechanical	Grease
80	125	22	1.1	1	91.5	113.5	72 500	90 500	6 000	—	5 300
	140	26	2	2	—	125.3	106 000	122 000	5 600	—	3 600
	140	26	2	2	95.3	—	160 000	167 000	5 000	8 000	4 500
	140	26	2	2	95.3	—	139 000	167 000	5 000	8 000	4 500
	140	33	2	2	95.3	—	214 000	243 000	5 000	7 100	4 000
	140	33	2	2	95.3	—	186 000	243 000	5 000	7 100	4 000
	170	39	2.1	2.1	—	147	190 000	207 000	4 800	—	2 800
	170	39	2.1	2.1	101	—	289 000	282 000	4 300	7 100	3 600
	170	39	2.1	2.1	101	—	256 000	282 000	4 300	7 100	3 600
	170	39	2.1	2.1	101	—	400 000	430 000	4 500	6 300	3 200
85	170	58	2.1	2.1	101	—	355 000	430 000	4 500	6 300	3 200
	200	48	3	3	110	170	299 000	315 000	4 000	—	2 600
	130	22	1.1	1	96.5	118.5	74 500	95 500	5 600	—	5 000
	150	28	2	2	—	133.8	120 000	140 000	5 300	—	3 400
	150	28	2	2	100.5	—	192 000	199 000	4 800	7 500	4 300
	150	28	2	2	100.5	—	167 000	199 000	4 800	7 500	4 300
	150	36	2	2	100.5	—	250 000	279 000	4 800	6 700	3 800
	150	36	2	2	100.5	—	217 000	279 000	4 800	6 700	3 800
	180	41	3	3	—	156	225 000	247 000	4 500	—	2 600
	180	41	3	3	108	—	212 000	228 000	4 800	—	2 600
90	180	41	3	3	108	—	360 000	330 000	4 000	6 700	3 400
	180	41	3	3	108	—	291 000	330 000	4 000	6 700	3 400
	180	60	3	3	108	—	485 000	485 000	4 300	6 000	3 000
	180	60	3	3	108	—	395 000	485 000	4 300	6 000	3 000
	210	52	4	4	113	177	335 000	350 000	4 000	—	3 000
	140	24	1.5	1.1	103	127	88 000	114 000	5 300	—	4 500
	160	30	2	2	—	143	152 000	178 000	5 000	—	3 200
	160	30	2	2	107	—	205 000	217 000	4 800	7 100	4 000
	160	30	2	2	107	—	182 000	217 000	4 800	7 100	4 000
	160	40	2	2	107	—	274 000	315 000	4 800	6 300	3 600

Bearing Designations	Abutment and Fillet Dimensions (mm)												Mass (kg)					
	Cage ⁽¹⁾ Standard Option	Cage ⁽²⁾					d _a ⁽³⁾ min.	d _b min.	d _b ⁽⁴⁾ max.	d _c min.	d _d min.	D _a ⁽³⁾ max.		D _b max.	D _b min.	r _a max.	r _b max.	
		NU	NJ	NUP	N	NF												
NU1016	(M)	—	NU	—	NUP	N	—	86.5	85	90	94	—	118.5	120	115	1	1	0.969
N 216	W	M	—	—	—	N	NF	89	—	—	—	—	131	128	2	2	1.47	
*NU216E	M	T, T7	NU	NJ	NUP	—	—	89	89	92	97	104	131	—	—	2	2	1.7
NU216E	M	T, T7	NU	NJ	NUP	—	—	89	89	92	97	104	131	—	—	2	2	1.7
*NU2216E	M	T, T7	NU	NJ	NUP	—	—	89	89	92	97	104	131	—	—	2	2	1.96
NU2216E	M	T, T7	NU	NJ	NUP	—	—	89	89	92	97	104	131	—	—	2	2	1.96
N 316	W	M	—	—	—	N	NF	91	—	—	—	—	159	150	2	2	3.85	
*NU316E	M	T, T7	NU	NJ	NUP	—	—	91	91	98	105	114	159	—	—	2	2	4.45
NU316E	M	T, T7	NU	NJ	NUP	—	—	91	91	98	105	114	159	—	—	2	2	4.45
*NU2316E	M	T, T7	NU	NJ	NUP	—	—	91	91	98	105	114	159	—	—	2	2	5.73
NU2316E	M	T, T7	NU	NJ	NUP	—	—	91	91	98	105	114	159	—	—	2	2	5.73
NU416	W	M	NU	NJ	—	N	NF	93	93	107	112	124	187	187	173	2.5	2.5	7.36
NU1017	(M)	—	NU	—	—	N	—	91.5	90	95	99	—	123.5	125	120	1	1	1.01
N 217	W	M	—	—	—	N	NF	94	—	—	—	—	141	137	2	2	1.87	
*NU217E	M	T, T7	NU	NJ	NUP	—	—	94	94	98	104	110	141	—	—	2	2	2.11
NU217E	M	T, T7	NU	NJ	NUP	—	—	94	94	98	104	110	141	—	—	2	2	2.11
*NU2217E	M	T, T7	NU	NJ	NUP	—	—	94	94	98	104	110	141	—	—	2	2	2.44
NU2217E	M	T, T7	NU	NJ	NUP	—	—	94	94	98	104	110	141	—	—	2	2	2.44
N 317	W	M	—	—	—	N	NF	98	—	—	—	—	167	159	2.5	2.5	4.53	
NU317	W	N	NU	NJ	NUP	—	—	98	98	105	110	119	167	—	—	2.5	2.5	4.6
*NU317E	M	—	NU	NJ	NUP	—	—	98	98	105	110	119	167	—	—	2.5	2.5	5.26
NU317E	M	T, T7	NU	NJ	NUP	—	—	98	98	105	110	119	167	—	—	2.5	2.5	5.26
*NU2317E	M	—	NU	NJ	NUP	—	—	98	98	105	110	119	167	—	—	2.5	2.5	6.77
NU2317E	M	T, T7	NU	NJ	NUP	—	—	98	98	105	110	119	167	—	—	2.5	2.5	6.77
NU417	M	—	NU	NJ	—	N	NF	101	101	110	115	128	194	194	180	3	3	9.56
NU1018	(M)	—	NU	—	NUP	N	—	98	96.5	101	106	—	132	133.5	129	1.5	1	1.35
N 218	W	M	—	—	—	N	NF	99	—	—	—	—	151	146	2	2	2.31	
*NU218E	M	T, T7	NU	NJ	NUP	—	—	99	99	104	109	116	151	—	—	2	2	2.6
NU218E	M	T, T7	NU	NJ	NUP	—	—	99	99	104	109	116	151	—	—	2	2	2.6
*NU2218E	M	T, T7	NU	NJ	NUP	—	—	99	99	104	109	116	151	—	—	2	2	3.11
NU2218E	M	T, T7	NU	NJ	NUP	—	—	99	99	104	109	116	151	—	—	2	2	3.11
N 318	W	M	—	—	—	N	NF	103	—	—	—	—	177	168	2.5	2.5	5.31	
NU318	W	M	NU	NJ	NUP	—	—	103	103	112	117	127	177	—	—	2.5	2.5	5.38
*NU318E	M	—	NU	NJ	NUP	—	—	103	103	111	117	127	177	—	—	2.5	2.5	6.1
NU318E	M	T, T7	NU	NJ	NUP	—	—	103	103	111	117	127	177	—	—	2.5	2.5	6.1
*NU2318E	M	—	NU	NJ	NUP	—	—	103	103	111	117	127	177	—	—	2.5	2.5	7.9
NU2318E	M	T, T7	NU	NJ	NUP	—	—	103	103	111	117	127	177	—	—	2.5	2.5	7.9
NU418	M	—	NU	NJ	—	N	NF	106	106	120	125	139	209	209	196	3	3	11.5

Notes (1) Cage designation (M) is usually omitted from the bearing designation.
 (2) When L-shaped thrust collars (see Pages C156-C157) are used, the bearings are considered the NH type.

Notes (3) If axial loads are applied, increase d_a and reduce D_a from the values listed above.
 (4) d_b (max.) refers to values for adjusting rings for NU and NJ bearings.
 (5) The limiting speeds (mechanical) in the bearing tables are for standard cages.

Remark Bearings denoted by an asterisk (*) are NSKHPS™ cylindrical roller bearings.

Bore Diameter 95 – 105 mm

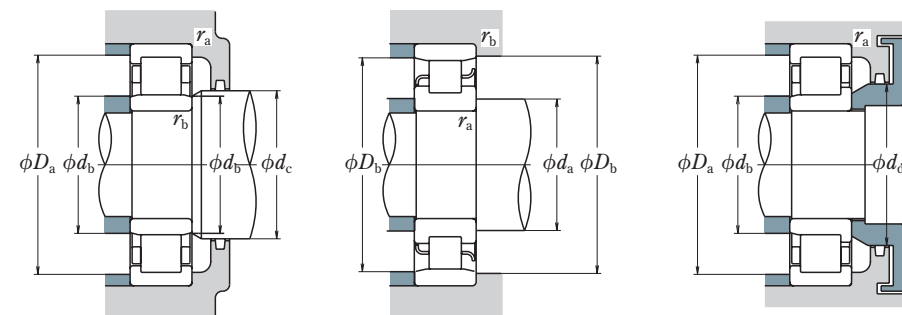
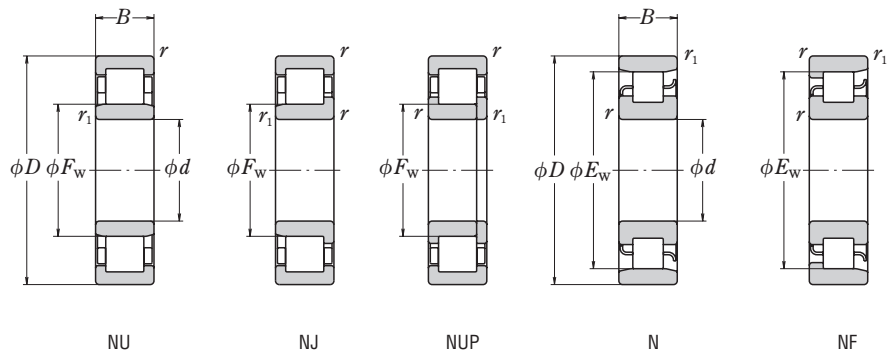

d	Boundary Dimensions (mm)						Basic Load Ratings (N)		Thermal Reference Speed	Speeds (min ⁻¹)		
	D	B	r	r ₁	F _w	E _w	C _r	C _{0r}		(⁵) Limiting Speeds		
95	145	24	1.5	1.1	108	132	90 000	120 000	5 000	—	4 300	
	170	32	2.1	2.1	—	151.5	166 000	196 000	4 800	—	3 000	
	170	32	2.1	2.1	112.5	—	249 000	265 000	4 300	6 700	3 800	
	170	32	2.1	2.1	112.5	—	220 000	265 000	4 300	6 700	3 800	
	170	43	2.1	2.1	112.5	—	325 000	370 000	4 500	6 000	3 400	
	170	43	2.1	2.1	112.5	—	286 000	370 000	4 500	6 000	3 400	
	200	45	3	3	—	173.5	259 000	289 000	4 300	—	2 400	
	200	45	3	3	121.5	—	259 000	289 000	4 300	—	2 400	
	200	45	3	3	121.5	—	410 000	385 000	3 800	6 000	3 000	
	200	45	3	3	121.5	—	335 000	385 000	3 800	6 000	3 000	
	200	67	3	3	121.5	—	565 000	585 000	3 800	5 300	2 600	
	200	67	3	3	121.5	—	460 000	585 000	3 800	5 300	2 600	
	240	55	4	4	133.5	201.5	400 000	445 000	3 200	—	2 600	
	100	150	24	1.5	1.1	113	137	93 000	126 000	4 800	—	4 300
		180	34	2.1	2.1	—	160	183 000	217 000	4 500	—	2 800
		180	34	2.1	2.1	119	—	305 000	305 000	4 300	6 300	3 600
		180	34	2.1	2.1	119	—	249 000	305 000	4 300	6 300	3 600
		180	46	2.1	2.1	119	—	410 000	445 000	4 300	5 600	3 200
		180	46	2.1	2.1	119	—	335 000	445 000	4 300	5 600	3 200
		215	47	3	3	—	185.5	299 000	335 000	4 000	—	2 200
		215	47	3	3	129.5	—	299 000	335 000	4 000	—	2 200
		215	47	3	3	127.5	—	465 000	425 000	3 600	5 600	2 800
		215	47	3	3	127.5	—	380 000	425 000	3 600	5 600	2 800
215		73	3	3	127.5	—	700 000	715 000	3 400	5 000	2 400	
215		73	3	3	127.5	—	570 000	715 000	3 400	5 000	2 400	
250		58	4	4	139	211	450 000	500 000	3 000	—	2 600	
105		160	26	2	1.1	119.5	145.5	109 000	149 000	4 500	—	4 000
		190	36	2.1	2.1	—	168.8	201 000	241 000	4 500	—	3 400
	190	36	2.1	2.1	125	—	320 000	310 000	4 300	6 000	3 400	
	190	36	2.1	2.1	125	—	262 000	310 000	4 300	6 000	3 400	
	225	49	3	3	—	195	340 000	390 000	3 800	—	2 200	
	225	49	3	3	133	—	525 000	480 000	3 400	5 300	2 600	
	225	49	3	3	133	—	425 000	480 000	3 400	5 300	2 600	
	260	60	4	4	144.5	220.5	495 000	555 000	2 800	—	2 400	

Bearing Designations	Abutment and Fillet Dimensions (mm)											Mass (kg)						
	Cage ⁽¹⁾ Standard Option					d _a ⁽²⁾ min.	d _b min.	d _b ⁽⁴⁾ max.	d _c	d _d	D _a ⁽³⁾ max.		D _b max.	D _b min.	r _a max.	r _b max.		
NU1019	(M)	—	NU	NJ	—							N					103	101.5
N 219	W	M	—	—	—	N	106	—	—	—	—	159	155	2	2	2	2.79	
* NU219E	M	T, T7	NU	NJ	—	NUP	106	106	110	116	123	159	—	—	2	2	3.17	
NU219E	M	T, T7	NU	NJ	—	NUP	—	106	106	110	116	123	159	—	2	2	3.17	
* NU2219E	M	T, T7	NU	NJ	—	NUP	—	106	106	110	116	123	159	—	2	2	3.81	
NU2219E	M	T, T7	NU	NJ	—	NUP	—	106	106	110	116	123	159	—	2	2	3.81	
N 319	W	M	—	—	—	N	108	—	—	—	—	187	177	2.5	2.5	6.09		
NU319	W	M	NU	NJ	—	NUP	108	108	118	124	134	187	—	—	2.5	2.5	6.23	
* NU319E	M	—	NU	NJ	—	NUP	108	108	118	124	134	187	—	—	2.5	2.5	7.13	
NU319E	M	T, T7	NU	NJ	—	NUP	—	108	108	118	124	134	187	—	—	2.5	2.5	7.13
* NU2319E	M	—	NU	NJ	—	NUP	—	108	108	118	124	134	187	—	—	2.5	2.5	9.21
NU2319E	M	T, T7	NU	NJ	—	NUP	—	108	108	118	124	134	187	—	—	2.5	2.5	9.21
NU419	M	—	NU	NJ	—	N	111	111	130	136	149	224	224	206	3	3	13.6	
NU1020	(M)	—	NU	NJ	—	NUP	108	106.5	111	116	—	142	143.5	139	1.5	1	1.47	
N 220	W	M	—	—	—	N	111	—	—	—	—	169	163	2	2	3.36		
* NU220E	M	—	NU	NJ	—	NUP	111	111	116	122	130	169	—	—	2	2	3.81	
NU220E	M	T, T7	NU	NJ	—	NUP	—	111	111	116	122	130	169	—	—	2	2	3.81
* NU2220E	M	—	NU	NJ	—	NUP	—	111	111	116	122	130	169	—	—	2	2	4.69
NU2220E	M	T, T7	NU	NJ	—	NUP	—	111	111	116	122	130	169	—	—	2	2	4.69
N 320	W	M	—	—	—	N	113	—	—	—	—	202	190	2.5	2.5	7.59		
NU320	W	M	NU	NJ	—	NUP	113	113	126	132	143	202	—	—	2.5	2.5	7.69	
* NU320E	M	—	NU	NJ	—	NUP	113	113	124	132	143	202	—	—	2.5	2.5	8.63	
NU320E	M	T, T7	NU	NJ	—	NUP	—	113	113	124	132	143	202	—	—	2.5	2.5	8.63
* NU2320E	M	—	NU	NJ	—	NUP	—	113	113	124	132	143	202	—	—	2.5	2.5	11.8
NU2320E	M	T, T7	NU	NJ	—	NUP	—	113	113	124	132	143	202	—	—	2.5	2.5	11.8
NU420	M	—	NU	NJ	—	N	116	116	135	141	156	234	234	215	3	3	15.5	
NU1021	(M)	—	NU	—	—	N	114	111.5	118	122	—	151	153.5	147	2	1	1.83	
N 221	W	M	—	—	—	N	116	—	—	—	—	179	172	2	2	4.0		
* NU221E	M	—	NU	NJ	—	NUP	116	116	121	129	137	179	—	—	2	2	4.58	
NU221E	M	—	NU	NJ	—	NUP	—	116	116	121	129	137	179	—	—	2	2	4.58
N 321	W	M	—	—	—	N	118	—	—	—	—	212	199	2.5	2.5	8.69		
* NU321E	M	—	NU	NJ	—	NUP	118	118	131	137	149	212	—	—	2.5	2.5	9.84	
NU321E	M	—	NU	NJ	—	NUP	—	118	118	131	137	149	212	—	—	2.5	2.5	9.84
NU421	M	—	NU	NJ	—	N	121	121	141	147	162	244	244	225	3	3	17.3	

Notes (1) Cage designation (M) is usually omitted from the bearing designation.
 (2) When L-shaped thrust collars (see Pages C156-C157) are used, the bearings are considered the NH type.

Notes (3) If axial loads are applied, increase d_a and reduce D_a from the values listed above.
 (4) d_b (max.) refers to values for adjusting rings for NU and NJ bearings.
 (5) The limiting speeds (mechanical) in the bearing tables are for standard cages.
Remark Bearings denoted by an asterisk (*) are NSKHPS™ cylindrical roller bearings.

SINGLE-ROW CYLINDRICAL ROLLER BEARINGS

Bore Diameter 110 – 130 mm

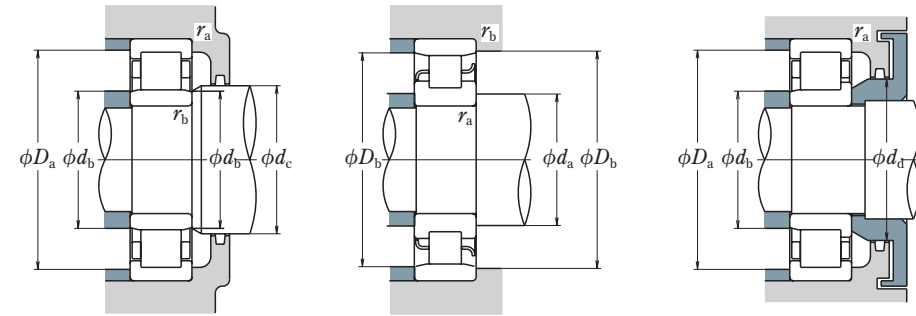
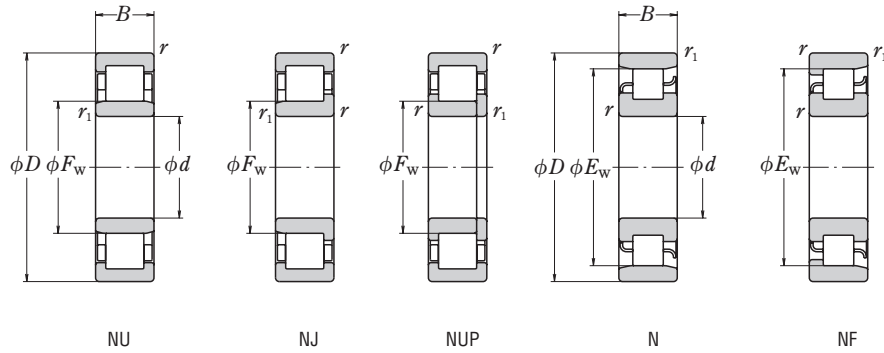

<i>d</i>	Boundary Dimensions (mm)						Basic Load Ratings (N)		Thermal Reference Speed	Speeds (min ⁻¹)	
	<i>D</i>	<i>B</i>	<i>r</i> _{min.}	<i>r</i> _{1 min.}	<i>F_W</i>	<i>E_W</i>	<i>C_r</i>	<i>C_{0r}</i>		Limiting Speeds	
										Mechanical	Grease
110	170	28	2	1.1	125	155	131 000	174 000	4 500	—	3 800
	200	38	2.1	2.1	—	178.5	229 000	272 000	4 300	—	2 600
	200	38	2.1	2.1	132.5	—	360 000	365 000	4 000	5 600	3 200
	200	38	2.1	2.1	132.5	—	293 000	365 000	4 000	5 600	3 200
	200	53	2.1	2.1	132.5	—	470 000	515 000	4 000	5 000	2 800
	200	53	2.1	2.1	132.5	—	385 000	515 000	4 000	5 000	2 800
	240	50	3	3	—	207	380 000	435 000	3 400	—	2 000
	240	50	3	3	143	—	555 000	525 000	3 200	5 000	2 600
	240	50	3	3	143	—	450 000	525 000	3 200	5 000	2 600
	240	80	3	3	143	—	830 000	880 000	3 000	4 500	2 200
	240	80	3	3	143	—	675 000	880 000	3 000	4 500	2 200
	280	65	4	4	155	—	550 000	620 000	2 600	—	2 200
120	180	28	2	1.1	135	165	139 000	191 000	4 000	—	3 400
	215	40	2.1	2.1	—	191.5	260 000	320 000	4 000	—	2 400
	215	40	2.1	2.1	143.5	—	410 000	420 000	3 600	5 300	3 000
	215	40	2.1	2.1	143.5	—	335 000	420 000	3 600	5 300	3 000
	215	58	2.1	2.1	143.5	—	555 000	620 000	3 600	4 800	2 600
	215	58	2.1	2.1	143.5	—	450 000	620 000	3 600	4 800	2 600
	260	55	3	3	—	226	450 000	510 000	3 000	—	2 200
	260	55	3	3	154	—	650 000	610 000	2 800	4 800	2 200
	260	55	3	3	154	—	530 000	610 000	2 800	4 800	2 200
	260	86	3	3	154	—	975 000	1 030 000	2 600	4 300	2 000
	260	86	3	3	154	—	795 000	1 030 000	2 600	4 300	2 000
	310	72	5	5	170	260	675 000	770 000	2 400	—	2 000
130	200	33	2	1.1	148	182	172 000	238 000	4 000	—	3 200
	230	40	3	3	—	204	270 000	340 000	3 800	—	2 200
	230	40	3	3	153.5	—	445 000	455 000	3 400	5 000	2 600
	230	40	3	3	153.5	—	365 000	455 000	3 400	5 000	2 600
	230	64	3	3	153.5	—	650 000	735 000	3 400	4 500	2 400
	230	64	3	3	153.5	—	530 000	735 000	3 400	4 500	2 400
	280	58	4	4	—	243	500 000	570 000	2 800	—	2 200
	280	58	4	4	167	—	760 000	735 000	2 600	4 300	2 200
	280	58	4	4	167	—	615 000	735 000	2 600	4 300	2 200
	280	93	4	4	167	—	1 130 000	1 230 000	2 400	3 800	1 900
	280	93	4	4	167	—	920 000	1 230 000	2 400	3 800	1 900
	340	78	5	5	185	285	825 000	955 000	2 000	—	1 800

Notes (1) Cage designation (M) is usually omitted from the bearing designation.
(2) When L-shaped thrust collars (see Pages C156-C157) are used, the bearings are considered the NH type.

Bearing Designations	Abutment and Fillet Dimensions (mm)										Mass (kg)									
	Cage ⁽¹⁾		Standard Option							<i>d_a</i> ⁽³⁾ _{min.}		<i>d_b</i> _{min.}	<i>d_b</i> ⁽⁴⁾ _{max.}	<i>d_c</i> _{min.}	<i>d_d</i> _{min.}	<i>D_a</i> ⁽³⁾ _{max.}	<i>D_b</i> _{max.}	<i>D_b</i> _{min.}	<i>r_a</i> _{max.}	<i>r_b</i> _{max.}
	(⁽²⁾)	(⁽²⁾)	NU	NJ	NUP	N	NF													
NU1022	(M)	—	NU	NJ	—	N	NF	119	116.5	123	128	—	161	163.5	157	2	1	—	—	2.27
N 222	W	M	—	—	—	N	NF	121	—	—	—	—	—	189	182	2	2	—	—	4.64
*NU222E	M	—	NU	NJ	NUP	—	—	121	121	129	135	144	189	—	—	2	2	—	—	5.37
NU222E	M	T, T7	—	NU	NJ	NUP	—	—	121	121	129	135	144	189	—	—	2	2	—	5.37
*NU222E	M	—	NU	NJ	NUP	—	—	121	121	129	135	144	189	—	—	2	2	—	—	7.65
NU222E	M	—	NU	NJ	NUP	—	—	121	121	129	135	144	189	—	—	2	2	—	—	7.65
N 322	W	M	—	—	—	N	NF	123	—	—	—	—	—	227	211	2.5	2.5	—	—	10.3
*NU322E	M	—	NU	NJ	NUP	—	—	123	123	139	145	158	227	—	—	2.5	2.5	—	—	11.8
NU322E	M	—	NU	NJ	NUP	—	—	123	123	139	145	158	227	—	—	2.5	2.5	—	—	11.8
*NU2322E	M	—	NU	NJ	NUP	—	—	123	123	139	145	158	227	—	—	2.5	2.5	—	—	18.8
NU2322E	M	—	NU	NJ	NUP	—	—	123	123	139	145	158	227	—	—	2.5	2.5	—	—	18.8
NU422	M	—	NU	NJ	—	—	—	126	126	151	157	173	264	—	—	3	3	—	—	22.1
NU1024	(M)	—	NU	NJ	NUP	N	—	129	126.5	133	138	—	171	173.5	167	2	1	—	—	2.43
N 224	W	M	—	—	—	N	NF	131	—	—	—	—	—	204	196	2	2	—	—	5.63
*NU224E	M	—	NU	NJ	NUP	—	—	131	131	140	146	156	204	—	—	2	2	—	—	6.43
NU224E	M	—	NU	NJ	NUP	—	—	131	131	140	146	156	204	—	—	2	2	—	—	6.43
*NU224E	M	—	NU	NJ	NUP	—	—	131	131	140	146	156	204	—	—	2	2	—	—	9.51
NU224E	M	—	NU	NJ	NUP	—	—	131	131	140	146	156	204	—	—	2	2	—	—	9.51
N 324	W	M	—	—	—	N	NF	133	—	—	—	—	—	247	230	2.5	2.5	—	—	12.9
*NU324E	M	—	NU	NJ	NUP	—	—	133	133	150	156	171	247	—	—	2.5	2.5	—	—	15
NU324E	M	—	NU	NJ	NUP	—	—	133	133	150	156	171	247	—	—	2.5	2.5	—	—	15
*NU2324E	M	—	NU	NJ	NUP	—	—	133	133	150	156	171	247	—	—	2.5	2.5	—	—	25
NU2324E	M	—	NU	NJ	NUP	—	—	133	133	150	156	171	247	—	—	2.5	2.5	—	—	25
NU424	M	—	NU	NJ	NUP	N	—	140	140	166	172	190	290	290	266	4	4	—	—	30.2
NU1026	(M)	—	NU	NJ	—	N	NF	139	136.5	146	151	—	191	193.5	184	2	1	—	—	3.66
N 226	W	M	—	—	—	N	NF	143	—	—	—	—	—	217	208	2.5	2.5	—	—	6.48
*NU226E	M	—	NU	NJ	NUP	—	—	143	143	150	158	168	217	—	—	2.5	2.5	—	—	8.03
NU226E	M	T, T7	—	NU	NJ	NUP	—	—	143	143	150	158	168	217	—	—	2.5	2.5	—	8.03
*NU226E	M	—	NU	NJ	NUP	—	—	143	143	150	158	168	217	—	—	2.5	2.5	—	—	9.44
NU226E	M	—	NU	NJ	NUP	—	—	143	143	150	158	168	217	—	—	2.5	2.5	—	—	9.44
N 326	M	—	—	—	—	N	NF	146	—	—	—	—	—	264	247.5	3	3	—	—	17.7
*NU326E	M	—	NU	NJ	NUP	—	—	146	146	163	169	184	264	—	—	3	3	—	—	18.7
NU326E	M	—	NU	NJ	NUP	—	—	146	146	163	169	184	264	—	—	3	3	—	—	18.7
*NU2326E	M	—	NU	NJ	NUP	—	—	146	146	163	169	184	264	—	—	3	3	—	—	30
NU2326E	M	—	NU	NJ	NUP	—	—	146	146	163	169	184	264	—	—	3	3	—	—	30
NU426	M	—	NU	NJ	—	NF	—	150	150	180	187	208	320	320	291	4	4	—	—	39.6

Notes (3) If axial loads are applied, increase *d_a* and reduce *D_a* from the values listed above.
(4) *d_b* (max.) refers to values for adjusting rings for NU and NJ bearings.
(5) The limiting speeds (mechanical) in the bearing tables are for standard cages.
Remark Bearings denoted by an asterisk (*) are NSKHPS™ cylindrical roller bearings.

■ SINGLE-ROW CYLINDRICAL ROLLER BEARINGS

Bore Diameter 140 – 160 mm

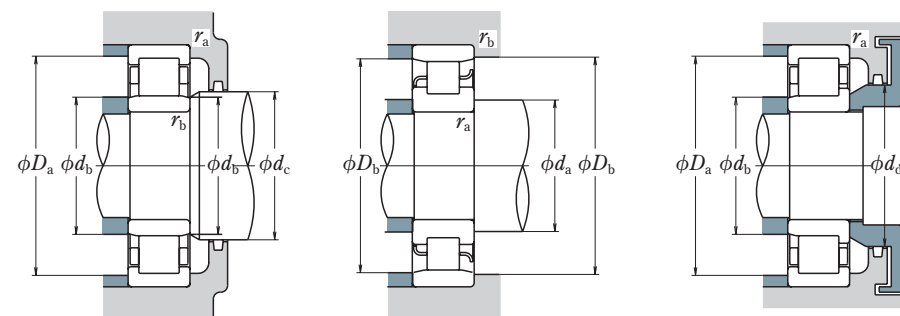
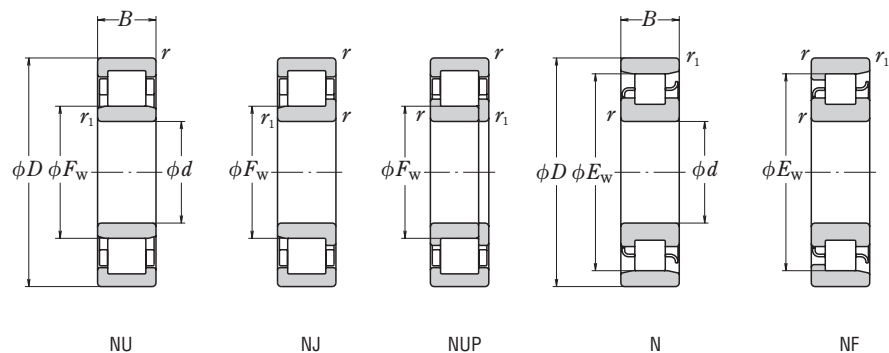

<i>d</i>	Boundary Dimensions (mm)						Basic Load Ratings (N)		Thermal Reference Speed	Speeds (min ⁻¹)	
	<i>D</i>	<i>B</i>	<i>r</i> _{min.}	<i>r</i> _{1 min.}	<i>F_w</i>	<i>E_w</i>	<i>C_r</i>	<i>C_{0r}</i>		Limiting Speeds	Grease
	(5)										
140	210	33	2	1.1	158	192	176 000	250 000	3 800	—	3 000
	250	42	3	3	—	221	297 000	375 000	3 400	—	2 000
	250	42	3	3	169	—	485 000	515 000	3 200	4 500	2 400
	250	42	3	3	169	—	395 000	515 000	3 200	4 500	2 400
	250	68	3	3	169	—	675 000	790 000	3 200	4 000	2 200
	250	68	3	3	169	—	550 000	790 000	3 200	4 000	2 200
	300	62	4	4	—	260	550 000	640 000	2 600	—	2 000
	300	62	4	4	180	—	815 000	795 000	2 400	4 000	2 000
	300	62	4	4	180	—	665 000	795 000	2 400	4 000	2 000
	300	102	4	4	180	—	1 250 000	1 380 000	2 200	2 600	1 700
150	225	35	2.1	1.5	169.5	205.5	202 000	294 000	3 600	—	2 800
	270	45	3	3	—	238	360 000	465 000	3 000	—	1 800
	270	45	3	3	182	—	550 000	595 000	2 800	4 300	2 200
	270	45	3	3	182	—	450 000	595 000	2 800	4 300	2 200
	270	73	3	3	182	—	780 000	930 000	2 800	3 800	2 000
	270	73	3	3	182	—	635 000	930 000	2 800	3 800	2 000
	320	65	4	4	—	277	665 000	805 000	2 200	—	1 800
	320	65	4	4	193	—	930 000	920 000	2 200	3 800	1 800
	320	65	4	4	193	—	760 000	920 000	2 200	3 800	1 800
	320	108	4	4	193	—	1 430 000	1 600 000	2 000	2 400	1 600
160	240	38	2.1	1.5	180	220	238 000	340 000	3 400	—	2 600
	290	48	3	3	—	255	430 000	570 000	2 800	—	2 200
	290	48	3	3	195	—	615 000	665 000	2 600	4 000	2 200
	290	48	3	3	195	—	500 000	665 000	2 600	4 000	2 200
	290	80	3	3	193	—	995 000	1 190 000	2 400	3 600	1 900
	290	80	3	3	193	—	810 000	1 190 000	2 400	3 600	1 900
	340	68	4	4	—	292	700 000	875 000	2 000	—	1 700
	340	68	4	4	204	—	1 060 000	1 050 000	1 900	3 600	1 700
	340	68	4	4	204	—	860 000	1 050 000	1 900	3 600	1 700
	340	114	4	4	204	—	1 310 000	1 820 000	1 800	2 400	1 500

Bearing Designations		Abutment and Fillet Dimensions (mm)													Mass (kg)			
Cage ⁽¹⁾ Standard Option	(2)	NU	NJ	NUP	N	NF	<i>d_a</i> ⁽³⁾	<i>d_b</i>	<i>d_b</i> ⁽⁴⁾	<i>d_c</i>	<i>d_d</i>	<i>D_a</i> ⁽³⁾	<i>D_b</i>	<i>D_b</i>	<i>r_a</i>	<i>r_b</i>	approx.	
							min.	min.	max.	min.	min.	max.	max.	min.	max.			
NU1028	(M)	—	NU	NJ	NUP	N	—	149	146.5	156	161	—	201	203.5	194	2	1	3.87
N 228	W	M	—	—	—	N	NF	153	—	—	—	—	237	225	2.5	2.5	8.08	
*NU228E	M	—	NU	NJ	NUP	—	—	153	153	165	171	182	237	—	—	2.5	2.5	9.38
NU228E	M	—	NU	NJ	NUP	—	—	153	153	165	171	182	237	—	—	2.5	2.5	9.38
*NU228E	M	—	NU	NJ	NUP	—	—	153	153	165	171	182	237	—	—	2.5	2.5	15.2
NU228E	M	—	NU	NJ	NUP	—	—	153	153	165	171	182	237	—	—	2.5	2.5	15.2
N 328	M	—	—	—	—	N	NF	156	—	—	—	—	284	266	3	3	21.7	
*NU328E	M	—	NU	NJ	NUP	—	—	156	156	176	182	198	284	—	—	3	3	22.8
NU328E	M	—	NU	NJ	NUP	—	—	156	156	176	182	198	284	—	—	3	3	22.8
*NU2328E	M	—	NU	NJ	NUP	—	—	156	156	176	182	198	284	—	—	3	3	37.7
NU2328E	M	—	NU	NJ	NUP	—	—	156	156	176	182	198	284	—	—	3	3	37.7
NU428	M	—	NU	NJ	—	N	—	160	160	193	200	222	340	340	308	4	4	46.4
NU1030	(M)	—	NU	NJ	—	N	NF	161	158	167	173	—	214	217	208	2	1.5	4.77
N 230	W	M	—	—	—	N	NF	163	—	—	—	—	257	242	2.5	2.5	10.4	
*NU230E	M	—	NU	NJ	NUP	—	—	163	163	177	184	196	257	—	—	2.5	2.5	11.9
NU230E	M	—	NU	NJ	NUP	—	—	163	163	177	184	196	257	—	—	2.5	2.5	11.9
*NU2230E	M	—	NU	NJ	NUP	—	—	163	163	177	184	196	257	—	—	2.5	2.5	19.3
NU2230E	M	—	NU	NJ	NUP	—	—	163	163	177	184	196	257	—	—	2.5	2.5	19.3
N 330	M	—	—	—	—	N	NF	166	—	—	—	—	304	283	3	3	25.8	
*NU330E	M	—	NU	NJ	NUP	—	—	166	166	188	195	213	304	—	—	3	3	27.1
NU330E	M	—	NU	NJ	NUP	—	—	166	166	188	195	213	304	—	—	3	3	27.1
*NU2330E	M	—	NU	NJ	NUP	—	—	166	166	188	195	213	304	—	—	3	3	45.1
NU2330E	M	—	NU	NJ	NUP	—	—	166	166	188	195	213	304	—	—	3	3	45.1
NU430	M	—	NU	NJ	—	—	—	170	170	208	216	237	360	—	—	4	4	55.8
NU1032	(M)	—	NU	NJ	—	N	NF	171	168	178	184	—	229	232	222	2	1.5	5.81
N 232	M	—	—	—	—	N	NF	173	—	—	—	—	277	261	2.5	2.5	14.1	
*NU232E	M	—	NU	NJ	NUP	—	—	173	173	190	197	210	277	—	—	2.5	2.5	14.7
NU232E	M	—	NU	NJ	NUP	—	—	173	173	190	197	210	277	—	—	2.5	2.5	14.7
*NU2232E	M	—	NU	NJ	NUP	—	—	173	173	188	197	210	277	—	—	2.5	2.5	24.5
NU2232E	M	—	NU	NJ	NUP	—	—	173	173	188	197	210	277	—	—	2.5	2.5	24.5
N 332	M	—	—	—	—	N	—	176	—	—	—	—	324	298	3	3	30.8	
*NU332E	M	—	NU	NJ	NUP	—	—	176	176	199	211	228	324	—	—	3	3	32.1
NU332E	M	—	NU	NJ	NUP	—	—	176	176	199	211	228	324	—	—	3	3	32.1
NU2332E	M	—	NU	NJ	NUP	—	—	176	176	199	211	228	324	—	—	3	3	53.9

Notes (1) Cage designation (M) is usually omitted from the bearing designation.
 (2) When L-shaped thrust collars (see Pages C156-C157) are used, the bearings are considered the NH type.

Notes (3) If axial loads are applied, increase *d_a* and reduce *D_a* from the values listed above.
 (4) *d_b* (max.) refers to values for adjusting rings for NU and NJ bearings.

(5) The limiting speeds (mechanical) in the bearing tables are for standard cages.
Remark Bearings denoted by an asterisk (*) are NSKHPS™ cylindrical roller bearings.

■ SINGLE-ROW CYLINDRICAL ROLLER BEARINGS

Bore Diameter 170 – 200 mm

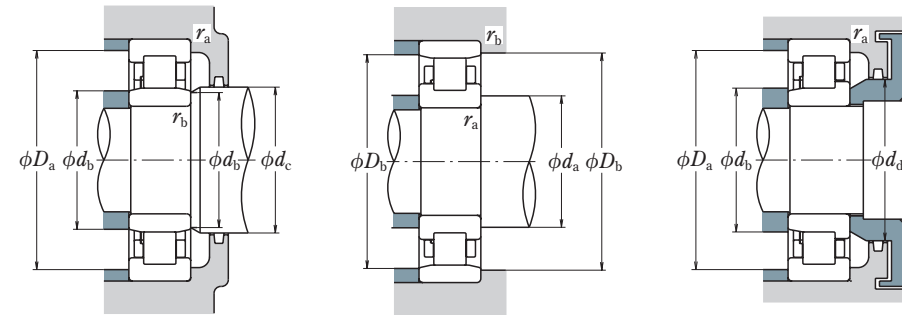
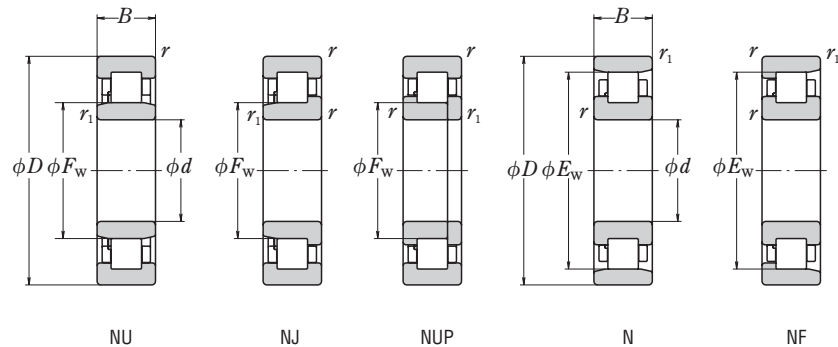

d	Boundary Dimensions (mm)						Basic Load Ratings (N)		Thermal Reference Speed	Speeds (min ⁻¹)	
	D	B	r min.	r ₁ min.	F _w	E _w	C _r	C _{0r}		Limiting Speeds	
										Mechanical	Grease
170	260	42	2.1	2.1	193	237	287 000	415 000	3 200	—	2 400
	310	52	4	4	—	272	475 000	635 000	2 600	—	2 000
	310	52	4	4	207	—	740 000	800 000	2 400	3 800	2 000
	310	52	4	4	207	—	605 000	800 000	2 400	3 800	2 000
	310	86	4	4	205	—	1 140 000	1 330 000	2 200	3 200	1 800
	310	86	4	4	205	—	925 000	1 330 000	2 200	3 200	1 800
	360	72	4	4	—	310	795 000	1 010 000	1 900	—	1 600
	360	72	4	4	218	—	930 000	1 150 000	1 800	3 400	1 600
	360	120	4	4	216	—	1 490 000	2 070 000	1 600	2 200	1 400
	180	280	46	2.1	2.1	205	255	355 000	510 000	3 000	—
320		52	4	4	—	282	495 000	675 000	2 400	—	1 900
320		52	4	4	217	—	770 000	850 000	2 200	3 600	1 900
320		52	4	4	217	—	625 000	850 000	2 200	3 600	1 900
320		86	4	4	215	—	1 240 000	1 510 000	2 000	3 200	1 700
320		86	4	4	215	—	1 010 000	1 510 000	2 000	3 200	1 700
380		75	4	4	—	328	905 000	1 150 000	1 700	—	1 500
380		75	4	4	231	—	985 000	1 230 000	1 700	2 800	1 500
380		126	4	4	227	—	1 560 000	2 220 000	1 500	2 000	1 300
190		290	46	2.1	2.1	215	265	365 000	535 000	2 800	—
	340	55	4	4	—	299	555 000	770 000	2 200	—	1 800
	340	55	4	4	230	—	855 000	955 000	2 000	3 400	1 800
	340	55	4	4	230	—	695 000	955 000	2 000	3 400	1 800
	340	92	4	4	228	—	1 360 000	1 670 000	1 900	3 000	1 600
	340	92	4	4	228	—	1 100 000	1 670 000	1 900	3 000	1 600
	400	78	5	5	—	345	975 000	1 260 000	1 600	—	1 400
	400	78	5	5	245	—	1 060 000	1 340 000	1 600	2 600	1 400
	400	132	5	5	240	—	1 770 000	2 520 000	1 400	2 000	1 300
	200	310	51	2.1	2.1	229	281	390 000	580 000	2 600	—
360		58	4	4	—	316	620 000	865 000	2 000	—	1 700
360		58	4	4	243	—	945 000	1 060 000	1 900	3 200	1 700
360		58	4	4	243	—	765 000	1 060 000	1 900	3 200	1 700
360		98	4	4	241	—	1 500 000	1 870 000	1 800	2 200	1 500
360		98	4	4	241	—	1 220 000	1 870 000	1 800	2 200	1 500
420		80	5	5	—	360	975 000	1 270 000	1 600	—	1 300
420		80	5	5	258	—	1 140 000	1 450 000	1 500	2 600	1 300
420		138	5	5	253	—	1 910 000	2 760 000	1 300	1 900	1 200

Bearing Designations	Abutment and Fillet Dimensions (mm)											Mass (kg)						
	Cage ⁽¹⁾ Standard Option	Cage ⁽²⁾					d _a ⁽³⁾ min.	d _b min.	d _b ⁽⁴⁾ max.	d _c	d _d		D _a ⁽³⁾ max.	D _b max.	D _b min.	r _a max.	r _b max.	
		NU	NJ	NUP	N	NF												
NU1034	(M)	—	NU	NJ	—	N	—	181	181	190	197	—	249	249	239	2	2	7.91
N 234	M	—	—	—	—	N	NF	186	—	—	—	—	294	278	3	3	17.4	
*NU234E	M	—	NU	NJ	NUP	—	—	186	186	202	211	223	294	—	—	3	3	18.3
NU234E	M	—	NU	NJ	NUP	—	—	186	186	202	211	223	294	—	—	3	3	18.3
*NU2234E	M	—	NU	NJ	NUP	—	—	186	186	200	211	223	294	—	—	3	3	29.9
NU2234E	M	—	NU	NJ	NUP	—	—	186	186	200	211	223	294	—	—	3	3	29.9
N 334	M	—	—	—	—	N	NF	186	—	—	—	—	344	316	3	3	36.6	
NU334E	M	—	NU	NJ	NUP	—	—	186	186	213	223	241	344	—	—	3	3	37.9
NU2334E	M	—	NU	NJ	NUP	—	—	186	186	210	223	241	344	—	—	3	3	63.4
NU1036	(M)	—	NU	NJ	—	N	NF	191	191	202	209	—	269	269	258	2	2	10.2
N 236	M	—	—	—	—	N	NF	196	—	—	—	—	304	288	3	3	18.1	
*NU236E	M	—	NU	NJ	NUP	—	—	196	196	212	221	233	304	—	—	3	3	19
NU236E	M	—	NU	NJ	NUP	—	—	196	196	212	221	233	304	—	—	3	3	19
*NU2236E	M	—	NU	NJ	NUP	—	—	196	196	210	221	233	304	—	—	3	3	31.4
NU2236E	M	—	NU	NJ	NUP	—	—	196	196	210	221	233	304	—	—	3	3	31.4
N 336	M	—	—	—	—	N	NF	196	—	—	—	—	364	335	3	3	42.6	
NU336E	M	—	NU	NJ	NUP	—	—	196	196	226	235	255	364	—	—	3	3	44
NU2336E	M	—	NU	NJ	NUP	—	—	196	196	222	235	255	364	—	—	3	3	74.6
NU1038	(M)	—	NU	NJ	—	N	—	201	201	212	219	—	279	279	268	2	2	10.7
N 238	M	—	—	—	—	N	NF	206	—	—	—	—	324	305	3	3	22	
*NU238E	M	—	NU	NJ	NUP	—	—	206	206	225	234	247	324	—	—	3	3	23
NU238E	M	—	NU	NJ	NUP	—	—	206	206	225	234	247	324	—	—	3	3	23
*NU2238E	M	—	NU	NJ	NUP	—	—	206	206	223	234	247	324	—	—	3	3	38.3
NU2238E	M	—	NU	NJ	NUP	—	—	206	206	223	234	247	324	—	—	3	3	38.3
N 338	M	—	—	—	—	N	—	210	—	—	—	—	380	352	4	4	48.7	
NU338E	M	—	NU	NJ	NUP	—	—	210	210	240	248	268	380	—	—	4	4	50.6
NU2338E	M	—	NU	NJ	NUP	—	—	210	210	235	248	268	380	—	—	4	4	86.2
NU1040	(M)	—	NU	NJ	—	N	NF	211	211	226	233	—	299	299	284	2	2	14
N 240	M	—	—	—	—	N	NF	216	—	—	—	—	344	323	3	3	26.2	
*NU240E	M	—	NU	NJ	NUP	—	—	216	216	238	247	261	344	—	—	3	3	27.4
NU240E	M	—	NU	NJ	NUP	—	—	216	216	238	247	261	344	—	—	3	3	27.4
*NU2240E	M	—	NU	NJ	NUP	—	—	216	216	235	247	261	344	—	—	3	3	46.1
NU2240E	M	—	NU	NJ	NUP	—	—	216	216	235	247	261	344	—	—	3	3	46.1
N 340	M	—	—	—	—	N	NF	220	—	—	—	—	400	367	4	4	55.3	
NU340E	M	—	NU	NJ	NUP	—	—	220	220	252	263	283	400	—	—	4	4	57.1
NU2340E	M	—	NU	NJ	NUP	—	—	220	220	247	263	283	400	—	—	4	4	99.3

Notes ⁽¹⁾ Cage designation (M) is usually omitted from the bearing designation.
⁽²⁾ When L-shaped thrust collars (see Pages C156-C157) are used, the bearings are considered the NH type.

Notes ⁽³⁾ If axial loads are applied, increase d_a and reduce D_a from the values listed above.
⁽⁴⁾ d_b (max.) refers to values for adjusting rings for NU and NJ bearings.
⁽⁵⁾ The limiting speeds (mechanical) in the bearing tables are for standard cages.

Remark Bearings denoted by an asterisk (*) are NSKHPS™ cylindrical roller bearings.

■ SINGLE-ROW CYLINDRICAL ROLLER BEARINGS

Bore Diameter 220 – 500 mm

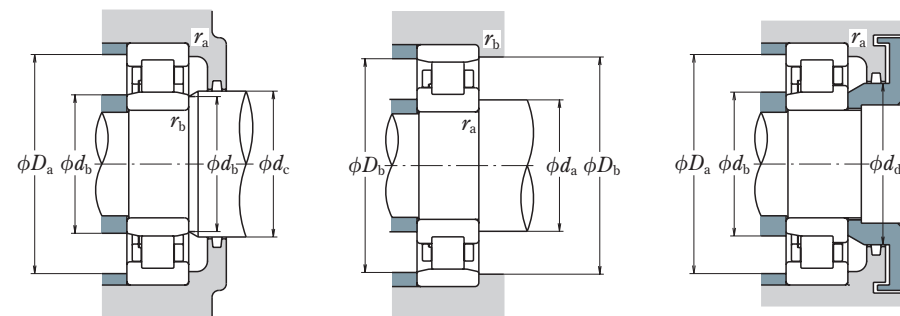
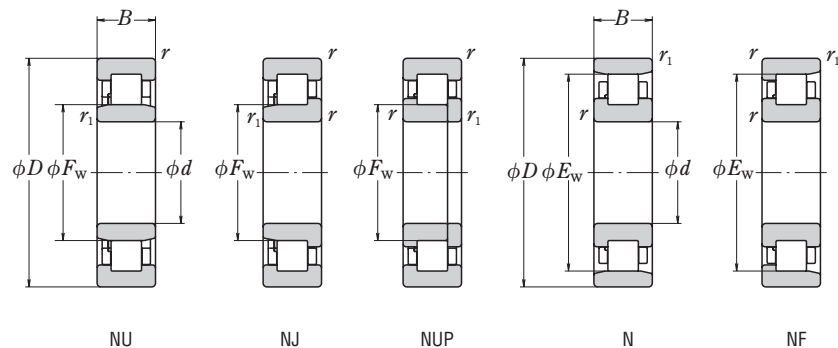

d	Boundary Dimensions (mm)						Basic Load Ratings (N)		Speeds (min ⁻¹)		
	D	B	r	r ₁	F _w	E _w	C _r	C _{0r}	Thermal Reference Speed	Limiting Speeds	
	min.	min.	min.	min.	min.	Mechanical				Grease	
220	340	56	3	3	250	310	500 000	750 000	2 400	—	1 800
400	65	4	4	—	350	—	760 000	1 080 000	1 800	—	1 500
400	65	4	4	268	—	—	1 110 000	1 250 000	1 800	—	1 500
400	65	4	4	268	—	—	905 000	1 250 000	1 800	—	1 500
400	108	4	4	270	—	—	1 140 000	1 810 000	1 700	—	1 300
460	88	5	5	—	396	—	1 190 000	1 570 000	1 400	—	1 200
460	88	5	5	284	—	—	1 190 000	1 570 000	1 400	—	1 200
240	360	56	3	3	270	330	530 000	820 000	2 200	—	1 600
440	72	4	4	—	385	—	935 000	1 340 000	1 600	—	1 300
440	72	4	4	295	—	—	935 000	1 340 000	1 600	—	1 300
440	120	4	4	295	—	—	1 440 000	2 320 000	1 500	—	1 200
500	95	5	5	—	430	—	1 360 000	1 820 000	1 200	—	1 100
500	95	5	5	310	—	—	1 360 000	1 820 000	1 200	—	1 100
260	400	65	4	4	296	364	645 000	1 000 000	1 900	—	1 500
480	80	5	5	—	420	—	1 100 000	1 580 000	1 500	—	1 200
480	80	5	5	320	—	—	1 100 000	1 580 000	1 500	—	1 200
480	130	5	5	320	—	—	1 710 000	2 770 000	1 300	—	1 100
540	102	6	6	336	—	—	1 540 000	2 090 000	1 100	—	1 000
280	420	65	4	4	316	384	660 000	1 050 000	1 800	—	1 400
500	80	5	5	—	440	—	1 140 000	1 680 000	1 300	—	1 100
500	80	5	5	340	—	—	1 140 000	1 680 000	1 300	—	1 100
300	460	74	4	4	340	420	885 000	1 400 000	1 600	—	1 300
540	85	5	5	364	—	—	1 400 000	2 070 000	1 200	—	1 100
320	480	74	4	4	360	440	905 000	1 470 000	1 500	—	1 200
580	92	5	5	—	510	—	1 540 000	2 270 000	1 100	—	950
580	92	5	5	390	—	—	1 540 000	2 270 000	1 100	—	950
340	520	82	5	5	385	475	1 080 000	1 740 000	1 400	—	1 100
360	540	82	5	5	405	495	1 110 000	1 830 000	1 300	—	1 000
380	560	82	5	5	425	—	1 140 000	1 910 000	1 200	—	1 000
400	600	90	5	5	450	550	1 360 000	2 280 000	1 100	—	900
420	620	90	5	5	470	570	1 390 000	2 380 000	1 100	—	850
440	650	94	6	6	493	—	1 470 000	2 530 000	1 000	—	800
460	680	100	6	6	516	624	1 580 000	2 740 000	950	—	750
480	700	100	6	6	536	644	1 620 000	2 860 000	900	—	750
500	720	100	6	6	556	664	1 660 000	2 970 000	900	—	710

Bearing Designations	Abutment and Fillet Dimensions (mm)										Mass (kg)		
	Cage ⁽¹⁾		NU		NJ		NUP		N			NF	
	Standard	Option	d _a ⁽²⁾ min.	d _b min.	d _b ⁽⁴⁾ max.	d _c min.	d _d min.	D _a ⁽³⁾ max.	D _b max.	D _b min.		r _a max.	r _b max.
NU1044	(M)	—	233	233	247	254	—	327	327	313	2.5	2.5	18.2
N 244	M	—	236	—	—	—	—	—	384	357	3	3	37
*NU244E	M	—	236	236	264	273	289	384	—	—	3	3	37.4
NU244E	M	—	236	236	264	273	289	384	—	—	3	3	37.4
NU2244	M	—	—	236	264	273	289	384	—	—	3	3	61.8
N 344	M	—	240	—	—	—	—	—	440	403	4	4	72.8
NU344	M	—	240	240	278	287	307	440	—	—	4	4	74.6
NU1048	(M)	—	253	253	266	275	—	347	347	333	2.5	2.5	19.5
N 248	M	—	256	—	—	—	—	—	424	392	3	3	49.6
NU248	M	—	256	256	289	298	316	424	—	—	3	3	50.4
NU2248	M	—	—	256	289	298	316	424	—	—	3	3	84.9
N 348	M	—	260	—	—	—	—	—	480	438	4	4	92.3
NU348	M	—	260	260	304	313	333	480	—	—	4	4	94.6
NU1052	(M)	—	276	276	292	300	—	384	384	367	3	3	29.1
N 252	M	—	280	—	—	—	—	—	460	428	4	4	66.2
NU252	M	—	280	280	314	323	343	460	—	—	4	4	67.1
NU2252	M	—	—	280	314	323	343	460	—	—	4	4	111
NU352	M	—	286	286	330	339	359	514	—	—	5	5	118
NU1056	(M)	—	296	296	312	320	—	404	404	387	3	3	30.8
N 256	M	—	300	—	—	—	—	—	480	448	4	4	69.6
NU256	M	—	300	300	334	344	364	480	—	—	4	4	70.7
NU1060	(M)	—	316	316	336	344	—	444	444	424	3	3	43.7
NU260	M	—	320	320	358	368	391	520	—	—	4	4	89.2
NU1064	(M)	—	336	336	356	365	—	464	464	444	3	3	46.1
N 264	M	—	340	—	—	—	—	—	560	519	4	4	110
NU264	M	—	340	340	384	394	420	560	—	—	4	4	112
NU1068	(M)	—	360	360	381	390	—	500	500	479	4	4	61.8
NU1072	(M)	—	380	380	400	410	—	520	520	499	4	4	64.6
NU1076	(M)	—	—	400	420	430	—	540	—	—	4	4	67.5
NU1080	(M)	—	420	420	445	455	—	580	580	554.5	4	4	88.2
NU1084	(M)	—	440	440	465	475	—	600	600	574.5	4	4	91.7
NU1088	(M)	—	—	466	488	498	—	624	—	—	5	5	105
NU1092	(M)	—	486	486	511	521	—	654	654	628.5	5	5	123
NU1096	(M)	—	506	506	531	541	—	674	674	654	5	5	127
NU10/500	(M)	—	526	526	551	558	—	694	694	674	5	5	131

Notes ⁽¹⁾ Cage designation (M) is usually omitted from the bearing designation.
⁽²⁾ When L-shaped thrust collars (see Pages C156-C157) are used, the bearings are considered the NH type.

Notes ⁽³⁾ If axial loads are applied, increase d_a and reduce D_a from the values listed above.
⁽⁴⁾ d_b (max.) refers to values for adjusting rings for NU and NJ bearings.
 Remark Bearings denoted by an asterisk (*) are NSKHPS™ cylindrical roller bearings.

■ CYLINDRICAL ROLLER BEARINGS

L-Shaped Thrust Collars

Bore Diameter 20 – 85 mm

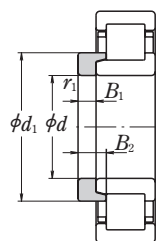

L-Shaped Thrust Collar

d	Boundary Dimensions (mm)				Bearing Designation	Mass (kg) approx.
	d ₁	B ₁	B ₂	r ₁ min.		
20	30	3	6.75	0.6	HJ 204	0.012
	29.8	3	5.5	0.6	HJ 204 E	0.011
	30	3	7.5	0.6	HJ 2204	0.012
25	29.8	3	6.5	0.6	HJ 2204 E	0.012
	31.7	4	7.5	0.6	HJ 304	0.017
	31.4	4	6.5	0.6	HJ 304 E	0.017
30	31.8	4	8.5	0.6	HJ 2304	0.017
	31.4	4	7.5	0.6	HJ 2304 E	0.018
	34.8	3	6	0.6	HJ 205 E	0.014
35	34.8	3	6.5	0.6	HJ 2205 E	0.014
	38.2	4	7	1.1	HJ 305 E	0.025
	38.2	4	8	1.1	HJ 2305 E	0.026
40	43.6	6	10.5	1.5	HJ 405	0.057
	41.3	4	7	0.6	HJ 206 E	0.025
	41.4	4	7.5	0.6	HJ 2206 E	0.025
45	45.1	5	8.5	1.1	HJ 306 E	0.042
	45.1	5	9.5	1.1	HJ 2306 E	0.043
	50.5	7	11.5	1.5	HJ 406	0.080
50	48.2	4	7	0.6	HJ 207 E	0.033
	48.2	4	8.5	0.6	HJ 2207 E	0.035
	51.1	6	9.5	1.1	HJ 307 E	0.060
55	51.1	6	11	1.1	HJ 2307 E	0.062
	59	8	13	1.5	HJ 407	0.12
	54.1	5	8.5	1.1	HJ 208 E	0.049
60	54.1	5	9	1.1	HJ 2208 E	0.050
	57.6	7	11	1.5	HJ 308 E	0.088
	57.7	7	12.5	1.5	HJ 2308 E	0.091
65	64.8	8	13	2	HJ 408	0.14
	59.1	5	8.5	1.1	HJ 209 E	0.055
	59.1	5	9	1.1	HJ 2209 E	0.055
70	64.5	7	11.5	1.5	HJ 309 E	0.11
	64.5	7	13	1.5	HJ 2309 E	0.113
	71.7	8	13.5	2	HJ 409	0.175
75	64.1	5	9	1.1	HJ 210 E	0.061
	71.4	8	13	2	HJ 2210 E	0.061
	71.4	8	14.5	2	HJ 310 E	0.151
80	78.8	9	14.5	2.1	HJ 2310 E	0.155
	78.8	9	14.5	2.1	HJ 410	0.23
	70.9	6	9.5	1.1	HJ 211 E	0.087
85	70.9	6	10	1.1	HJ 2211 E	0.088
	77.6	9	14	2	HJ 311 E	0.195
	77.6	9	15.5	2	HJ 2311 E	0.20
90	85.2	10	16.5	2.1	HJ 411	0.29
	77.7	6	10	1.5	HJ 212 E	0.108
	77.7	6	10	1.5	HJ 2212 E	0.108
95	84.5	9	14.5	2.1	HJ 312 E	0.231
	84.5	9	16	2.1	HJ 2312 E	0.237
	91.8	10	16.5	2.1	HJ 412	0.34
100	84.5	6	10	1.5	HJ 213 E	0.129
	84.5	6	10.5	1.5	HJ 2213 E	0.131
	90.6	10	15.5	2.1	HJ 313 E	0.288
105	90.6	10	18	2.1	HJ 2313 E	0.298
	98.5	11	18	2.1	HJ 413	0.42
	89.5	7	11	1.5	HJ 214 E	0.157
110	89.5	7	11.5	1.5	HJ 2214 E	0.158
	97.5	10	15.5	2.1	HJ 314 E	0.33
	97.5	10	18.5	2.1	HJ 2314 E	0.345
115	110.5	12	20	3	HJ 414	0.605
	94.5	7	11	1.5	HJ 215 E	0.166
	94.5	7	11.5	1.5	HJ 2215 E	0.167
120	104.2	11	16.5	2.1	HJ 315 E	0.41
	104.2	11	19.5	2.1	HJ 2315 E	0.43
	116	13	21.5	3	HJ 415	0.71
125	101.6	8	12.5	2	HJ 216 E	0.222
	101.6	8	12.5	2	HJ 2216 E	0.222
	110.6	11	17	2.1	HJ 316 E	0.46
130	111	11	20	2.1	HJ 2316 E	0.48
	122	13	22	3	HJ 416	0.78
	107.6	8	12.5	2	HJ 217 E	0.25
135	107.6	8	13	2	HJ 2217 E	0.252
	117.9	12	18.5	3	HJ 317 E	0.575
	117.9	12	22	3	HJ 2317 E	0.595
140	126	14	24	4	HJ 417	0.88
	114.3	9	14	2	HJ 218 E	0.32
	114.3	9	15	2	HJ 2218 E	0.325
145	124.2	12	18.5	3	HJ 318 E	0.63
	124.2	12	22	3	HJ 2318 E	0.66
	137	14	24	4	HJ 418	1.05
150	120.6	9	14	2.1	HJ 219 E	0.355
	120.6	9	15.5	2.1	HJ 2219 E	0.365
	132.2	13	20.5	3	HJ 319 E	0.785
155	132.2	13	24.5	3	HJ 2319 E	0.815
	147	15	25.5	4	HJ 419	1.3
	127.5	10	15	2.1	HJ 220 E	0.44
160	127.5	10	16	2.1	HJ 2220 E	0.45
	139.6	13	20.5	3	HJ 320 E	0.89
	139.6	13	23.5	3	HJ 2320 E	0.92
165	153.5	16	27	4	HJ 420	1.5
	145	13	20.5	3	HJ 321 E	0.97
	159.5	16	27	4	HJ 421	1.65
170	141.7	11	17	2.1	HJ 222 E	0.62
	141.7	11	19.5	2.1	HJ 2222 E	0.645
	155.8	14	22	3	HJ 322 E	1.21
175	155.8	14	26.5	3	HJ 2322 E	1.27
	171	17	29.5	4	HJ 422	2.1
	153.4	11	17	2.1	HJ 224 E	0.71
180	153.4	11	20	2.1	HJ 2224 E	0.745
	168.6	14	22.5	3	HJ 324 E	1.41
	168.6	14	26	3	HJ 2324 E	1.46
185	188	17	30.5	5	HJ 424	2.6
	164.2	11	17	3	HJ 226 E	0.79
	164.2	11	21	3	HJ 2226 E	0.84
190	182.3	14	23	4	HJ 326 E	1.65
	182.3	14	28	4	HJ 2326 E	1.73
	205	18	32	5	HJ 426	3.3
195	180	11	18	3	HJ 228 E	0.99
	180	11	23	3	HJ 2228 E	1.07
	196	15	25	4	HJ 328 E	2.04
200	196	15	31	4	HJ 2328 E	2.14
	219	18	33	5	HJ 428	3.75

Bore Diameter 90 – 320 mm

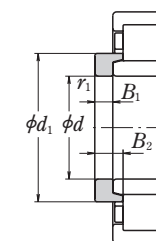

L-Shaped Thrust Collar

d	Boundary Dimensions (mm)				Bearing Designation	Mass (kg) approx.
	d ₁	B ₁	B ₂	r ₁ min.		
150	193.7	12	19.5	3	HJ 230 E	1.26
	193.7	12	24.5	3	HJ 2230 E	1.35
	210	15	25	4	HJ 330 E	2.35
155	210	15	31.5	4	HJ 2330 E	2.48
	234	20	36.5	5	HJ 430	4.7
	207.3	12	20	3	HJ 232 E	1.48
160	206.1	12	24.5	3	HJ 2232 E	1.55
	222	15	25	4	HJ 332 E	2.59
	222.1	15	32	4	HJ 2332 E	2.76
165	220.8	12	20	4	HJ 234 E	1.7
	219.5	12	24	4	HJ 2234 E	1.79
	238	16	33.5	4	HJ 430 E	3.25
170	230.8	12	20	4	HJ 236 E	1.79
	229.5	12	24	4	HJ 2236 E	1.88
	252	17	35	4	HJ 436 E	3.85
175	244.5	13	21.5	4	HJ 238 E	2.19
	243.2	13	26.5	4	HJ 2238 E	2.31
	260.6	18	36.5	5	HJ 438 E	4.45
180	258.2	14	23	4	HJ 240 E	2.65
	258	14	34	4	HJ 2240	2.6
	256.9	14	28	4	HJ 2240 E	2.78
185	280	18	30	5	HJ 340 E	5.0
	286	15	27.5	4	HJ 244	3.55
	286	15	36.5	4	HJ 2244	3.55
190	307	20	36	5	HJ 344	7.05
	313	16	29.5	4	HJ 248	4.65
	313	16	38.5	4	HJ 2248	4.65
195	334	22	39.5	5	HJ 348	8.2
	340	18	33	5	HJ 252	6.2
	340	18	40.5	5	HJ 2252	6.2
200	362	24	43	6	HJ 352	11.4
	360	18	33	5	HJ 256	7.4
	387	20	34.5	5	HJ 260	9.15
205	415	21	37	5	HJ 264	11.3

DOUBLE-ROW CYLINDRICAL ROLLER BEARINGS

Bore Diameter 25 – 140 mm

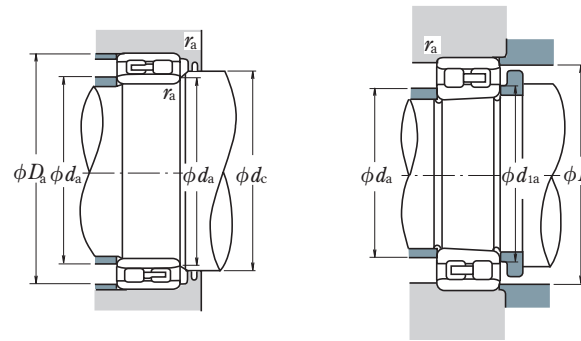
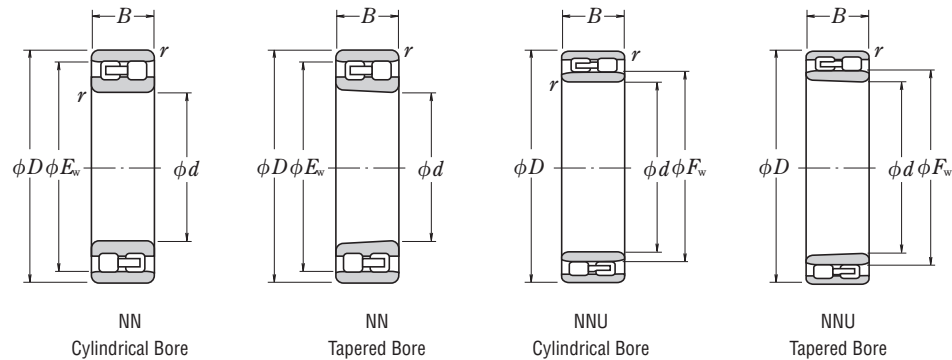

d	Boundary Dimensions (mm)					Basic Load Ratings (N)		Limiting Speeds (min ⁻¹)	
	D	B	r min.	F _w	E _w	C _r	C _{0r}	Grease	Oil
25	47	16	0.6	—	41.3	25 800	30 000	14 000	17 000
30	55	19	1	—	48.5	31 000	37 000	12 000	14 000
35	62	20	1	—	55	39 500	50 000	10 000	12 000
40	68	21	1	—	61	43 500	55 500	9 000	11 000
45	75	23	1	—	67.5	52 000	68 500	8 500	10 000
50	80	23	1	—	72.5	53 000	72 500	7 500	9 000
55	90	26	1.1	—	81	69 500	96 500	6 700	8 000
60	95	26	1.1	—	86.1	73 500	106 000	6 300	7 500
65	100	26	1.1	—	91	77 000	116 000	6 000	7 100
70	110	30	1.1	—	100	97 500	148 000	5 600	6 700
75	115	30	1.1	—	105	96 500	149 000	5 300	6 300
80	125	34	1.1	—	113	119 000	186 000	4 800	6 000
85	130	34	1.1	—	118	125 000	201 000	4 500	5 600
90	140	37	1.5	—	127	143 000	228 000	4 300	5 000
95	145	37	1.5	—	132	150 000	246 000	4 000	5 000
100	140	40	1.1	112	—	155 000	295 000	4 000	5 000
	150	37	1.5	—	137	157 000	265 000	4 000	4 800
105	145	40	1.1	117	—	161 000	315 000	3 800	4 800
	160	41	2	—	146	198 000	320 000	3 800	4 500
110	150	40	1.1	122	—	167 000	335 000	3 600	4 500
	170	45	2	—	155	229 000	375 000	3 400	4 300
120	165	45	1.1	133.5	—	183 000	360 000	3 200	4 000
	180	46	2	—	165	239 000	405 000	3 200	3 800
130	180	50	1.5	144	—	274 000	545 000	3 000	3 800
	200	52	2	—	182	284 000	475 000	3 000	3 600
140	190	50	1.5	154	—	283 000	585 000	2 800	3 600
	210	53	2	—	192	298 000	515 000	2 800	3 400

Bearing Designations		Abutment and Fillet Dimensions (mm)						Mass (kg)
Cylindrical Bore	Tapered Bore ⁽¹⁾	d _a ⁽²⁾		d _{1a}	d _c	D _a	r _a	approx.
		min.	max.	min.	max.	min.	max.	
NN 3005	NN 3005 KR	29	—	29	—	43	42	0.127
NN 3006	NN 3006 KR	35	—	36	—	50	50	0.198
NN 3007	NN 3007 KR	40	—	41	—	57	56	0.258
NN 3008	NN 3008 KR	45	—	46	—	63	62	0.309
NN 3009	NN 3009 KR	50	—	51	—	70	69	0.407
NN 3010	NN 3010 KR	55	—	56	—	75	74	0.436
NN 3011	NN 3011 KR	61.5	—	62	—	83.5	83	0.647
NN 3012	NN 3012 KR	66.5	—	67	—	88.5	88	0.693
NN 3013	NN 3013 KR	71.5	—	72	—	93.5	93	0.741
NN 3014	NN 3014 KR	76.5	—	77	—	103.5	102	1.06
NN 3015	NN 3015 KR	81.5	—	82	—	108.5	107	1.11
NN 3016	NN 3016 KR	86.5	—	87	—	118.5	115	1.54
NN 3017	NN 3017 KR	91.5	—	92	—	123.5	120	1.63
NN 3018	NN 3018 KR	98	—	99	—	132	129	2.09
NN 3019	NN 3019 KR	103	—	104	—	137	134	2.19
NNU 4920	NNU 4920 KR	106.5	111	108	115	133.5	—	1.9
NN 3020	NN 3020 KR	108	—	109	—	142	139	2.28
NNU 4921	NNU 4921 KR	111.5	116	113	120	138.5	—	1.99
NN 3021	NN 3021 KR	114	—	115	—	151	148	2.88
NNU 4922	NNU 4922 KR	116.5	121	118	125	143.5	—	2.07
NN 3022	NN 3022 KR	119	—	121	—	161	157	3.71
NNU 4924	NNU 4924 KR	126.5	133	128	137	158.5	—	2.85
NN 3024	NN 3024 KR	129	—	131	—	171	167	4.04
NNU 4926	NNU 4926 KR	138	143	140	148	172	—	3.85
NN 3026	NN 3026 KR	139	—	141	—	191	185	5.88
NNU 4928	NNU 4928 KR	148	153	150	158	182	—	4.08
NN 3028	NN 3028 KR	149	—	151	—	201	195	6.34

Note ⁽¹⁾ Suffix KR represents bearings with tapered bores (taper 1 : 12).

Remark Double-row cylindrical roller bearings are generally produced in high precision classes (Class 5 or better).

Note ⁽²⁾ d_a (max.) refers to values for adjusting rings for NNU bearings.

DOUBLE-ROW CYLINDRICAL ROLLER BEARINGS

Bore Diameter 150 – 360 mm

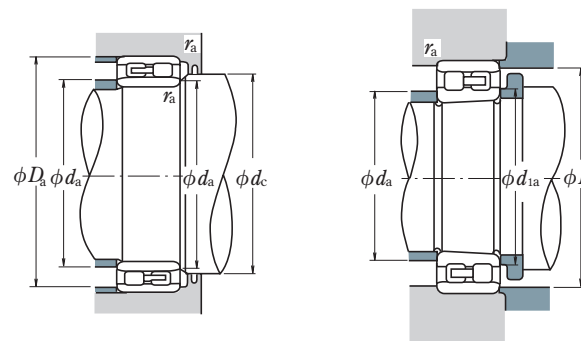
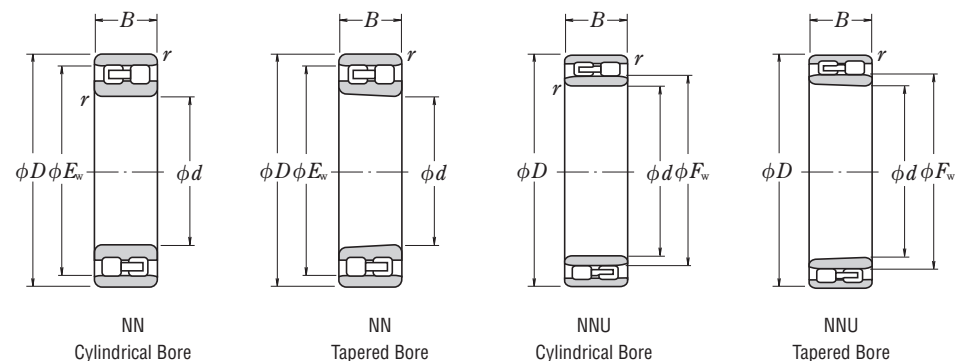

d	Boundary Dimensions (mm)					Basic Load Ratings (N)		Limiting Speeds (min ⁻¹)	
	D	B	r min.	F _w	E _w	C _r	C _{0r}	Grease	Oil
150	210	60	2	167	—	350 000	715 000	2 600	3 200
	225	56	2.1	—	206	335 000	585 000	2 600	3 000
160	220	60	2	177	—	365 000	760 000	2 400	3 000
	240	60	2.1	—	219	375 000	660 000	2 400	2 800
170	230	60	2	187	—	375 000	805 000	2 400	2 800
	260	67	2.1	—	236	450 000	805 000	2 200	2 600
180	250	69	2	200	—	480 000	1 020 000	2 200	2 600
	280	74	2.1	—	255	565 000	995 000	2 000	2 400
190	260	69	2	211.5	—	485 000	1 060 000	2 000	2 600
	290	75	2.1	—	265	595 000	1 080 000	2 000	2 400
200	280	80	2.1	223	—	570 000	1 220 000	1 900	2 400
	310	82	2.1	—	282	655 000	1 170 000	1 800	2 200
220	300	80	2.1	243	—	600 000	1 330 000	1 700	2 200
	340	90	3	—	310	815 000	1 480 000	1 700	2 000
240	320	80	2.1	263	—	625 000	1 450 000	1 600	2 000
	360	92	3	—	330	855 000	1 600 000	1 500	1 800
260	360	100	2.1	289	—	935 000	2 100 000	1 400	1 800
	400	104	4	—	364	1 030 000	1 920 000	1 400	1 700
280	380	100	2.1	309	—	960 000	2 230 000	1 300	1 700
	420	106	4	—	384	1 080 000	2 080 000	1 300	1 500
300	420	118	3	336	—	1 230 000	2 870 000	1 200	1 500
	460	118	4	—	418	1 290 000	2 460 000	1 200	1 400
320	440	118	3	356	—	1 260 000	3 050 000	1 100	1 400
	480	121	4	—	438	1 350 000	2 670 000	1 100	1 300
340	520	133	5	—	473	1 670 000	3 300 000	1 000	1 200
360	540	134	5	—	493	1 700 000	3 450 000	950	1 200

Bearing Designations		Abutment and Fillet Dimensions (mm)							Mass (kg)
Cylindrical Bore	Tapered Bore ⁽¹⁾	d _a ⁽²⁾		d _{1a}	d _c	D _a	r _a	approx.	
		min.	max.	min.	min.	max.	min.		max.
NNU 4930 NN 3030	NNU 4930 KR NN 3030 KR	159	166	162	171	201	—	2	6.39
		161	—	162	—	214	209	2	7.77
NNU 4932 NN 3032	NNU 4932 KR NN 3032 KR	169	176	172	182	211	—	2	6.76
		171	—	172	—	229	222	2	9.41
NNU 4934 NN 3034	NNU 4934 KR NN 3034 KR	179	186	182	192	221	—	2	7.12
		181	—	183	—	249	239	2	12.8
NNU 4936 NN 3036	NNU 4936 KR NN 3036 KR	189	199	193	205	241	—	2	10.4
		191	—	193	—	269	258	2	16.8
NNU 4938 NN 3038	NNU 4938 KR NN 3038 KR	199	211	203	217	251	—	2	10.9
		201	—	203	—	279	268	2	17.8
NNU 4940 NN 3040	NNU 4940 KR NN 3040 KR	211	222	214	228	269	—	2	15.3
		211	—	214	—	299	285	2	22.7
NNU 4944 NN 3044	NNU 4944 KR NN 3044 KR	231	242	234	248	289	—	2	16.6
		233	—	236	—	327	313	2.5	29.6
NNU 4948 NN 3048	NNU 4948 KR NN 3048 KR	251	262	254	269	309	—	2	18
		253	—	256	—	347	334	2.5	32.7
NNU 4952 NN 3052	NNU 4952 KR NN 3052 KR	271	288	275	295	349	—	2	31.1
		276	—	278	—	384	368	3	47.7
NNU 4956 NN 3056	NNU 4956 KR NN 3056 KR	291	308	295	315	369	—	2	33
		296	—	298	—	404	388	3	51.1
NNU 4960 NN 3060	NNU 4960 KR NN 3060 KR	313	335	318	343	407	—	2.5	51.9
		316	—	319	—	444	422	3	70.7
NNU 4964 NN 3064	NNU 4964 KR NN 3064 KR	333	355	338	363	427	—	2.5	54.9
		336	—	340	—	464	442	3	76.6
NN 3068	NN 3068 KR	360	—	365	—	500	477	4	102
NN 3072	NN 3072 KR	380	—	385	—	520	497	4	106

Note ⁽¹⁾ Suffix KR represents bearings with tapered bores (taper 1 : 12).

Remark Double-row cylindrical roller bearings are generally produced in high precision classes (Class 5 or better).

Note ⁽²⁾ d_a (max.) refers to values for adjusting rings for NNU bearings.

FULL COMPLEMENT SINGLE-ROW (NCF) / DOUBLE-ROW (NNCF) CYLINDRICAL ROLLER BEARINGS

Design, Types, and Features

Cageless, full complement cylindrical roller bearings have the maximum possible number of rollers and can sustain much heavier loads than cylindrical roller bearings of the same size with cages. On the other hand, high-speed capability is inferior to the bearings with cages.

Open single- and double-row bearings are mostly used in general industrial applications at low speed and under heavy load, while shielded double-row bearings are often used in crane sheaves.

Table 1 Features of Full Complement Cylindrical Roller Bearings

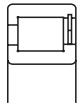
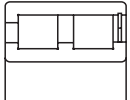
Appearance	Type	Design and Features
	NCF	The outer and inner rings and rollers are inseparable since a retaining snap ring is installed at the side opposite the outer ring rib. It can sustain axial loads in only one direction.
	NNCF	NNCF is a double-row version of NCF. It can sustain heavy radial loads.

Tolerances and Running AccuracyTable 7.2 (Pages A128 to A131)

Single-Row
Double-Row

Recommended Fits

Single-Row
Double-Row

Inner Ring RotationTable 8.3 (Page A164)
Table 8.5 (Page A165)

Outer Ring RotationTable 2 below

Table 2 Fits and Internal Clearances for Full Complement Cylindrical Roller Bearings

Operating Conditions		Fitting Between Inner Ring and Shaft	Fitting Between Outer Ring and Housing Bore	Recommended Internal Clearance
Outer Ring Rotation	Thin-walled housings and heavy loads	g6 or h6	P7	C 3
	Normal to heavy loads	g6 or h6	N7	C 3
	Light or fluctuating loads	g6 or h6	M7	CN

Permissible Misalignment

The permissible misalignment of full complement single-row cylindrical roller bearings is generally 0.0006 radian (2') under normal load. For double-row bearings, nearly no misalignment is allowed.

FULL COMPLEMENT CYLINDRICAL ROLLER BEARINGS FOR SHEAVES

DESIGN, TYPES, AND FEATURES

Cylindrical roller bearings for sheaves are specially designed thin-walled, broad-width, full complement double-row bearings. They are also widely used in general industrial machines running at low speed and under heavy loads. There are several Series, as shown in Table 1.

Table 1 Series of Cylindrical Roller Bearings for Sheaves

Bearing Type		Fixed-End	Free-End
Open Type	Without Snap Ring	RS-48E4 RS-49E4	RSF-48E4 RSF-49E4
	Shielded Type	Without Snap Ring With Snap Ring	RS-50 RS-50NR

All bearings are inseparable, and the RSF type can be used as a free-end bearing. In this case, please refer to the permissible axial displacement in the bearing tables.

Since these cylindrical roller bearings are double-row and full complement, they can withstand heavy shock loads and moments and have sufficient axial load capacity for use in sheaves.

Shielded bearing units allow for the reduction of the number of parts surrounding the bearing, therefore allowing for a simple, compact design.

The surface of these bearings is treated with a rust preventive.

Table 2 Features of Full Complement Cylindrical Roller Bearings for Sheaves

Diagram	Type	Design and Features
	RS-48E4 RS-49E4	These types feature a double-row outer ring with center rib and two single-row inner rings with ribs. The outer and inner rings and rollers are inseparable since there are two retaining snap rings at the sides of the outer ring. They can sustain an axial load in either direction, so they may be used as fixed-end bearings. An oil groove and holes are located at the center of the outer ring.
	RSF-48E4 RSF-49E4	These types feature a double-row outer ring without ribs and a double-row inner ring with three ribs. The outer and inner rings and rollers are inseparable since there is a retaining snap ring at the middle of the outer ring. They can be used as free-end bearings, and permissible axial movement is listed in the bearing tables. An oil groove and holes are located at the center of the outer ring.
	RS-50 RS-50NR	These types are shielded on both sides and feature a double-row outer ring with center rib and two inner rings with ribs. They can sustain an axial load in either direction. They are prelubricated, but it is possible to replenish the grease through an oil groove and hole. The RS-50NR type is designated if there are snap rings at the outside of the outer ring. Surfaces are treated with a rust preventive.

TOLERANCES AND RUNNING ACCURACY..... Table 7.2 (Pages A128 to A131)

RECOMMENDED FITS AND INTERNAL CLEARANCES

When used with outer ring rotation for sheaves or wheels, the fit and radial internal clearance should conform to Table 3.

Table 3 Fits and Internal Clearances for Cylindrical Roller Bearings for Sheaves

Operating Conditions		Fitting Between Inner Ring and Shaft	Fitting Between Outer Ring and Housing Bore	Recommended Internal Clearance
Outer Ring Rotation	Thin-walled housings and heavy loads	g6 or h6	P7	C3
	Normal to heavy loads	g6 or h6	N7	C3
	Light or fluctuating loads	g6 or h6	M7	CN

The fits listed in Tables 8.3 (Page A164) and 8.5 (Page A165) apply when used with inner ring rotation in general applications, and internal clearance should conform to Table 4.

Table 4 Units : m

Nominal Bore Dia. d (mm)	Clearances			
	CN		C3	
over incl.	min.	max.	min.	max.
30 40	15	50	35	70
40 50	20	55	40	75
50 65	20	65	45	90
65 80	25	75	55	105
80 100	30	80	65	115
100 120	35	90	80	135
120 140	40	105	90	155
140 160	50	115	100	165
160 180	60	125	110	175
180 200	65	135	125	195
200 225	75	150	140	215
225 250	90	165	155	230
250 280	100	180	175	255
280 315	110	195	195	280
315 355	125	215	215	305
355 400	140	235	245	340
400 450	155	275	270	390
450 500	180	300	300	420

■ FULL COMPLEMENT CYLINDRICAL ROLLER BEARINGS

NCF Type, Single-Row

Bore Diameter 100 – 260 mm

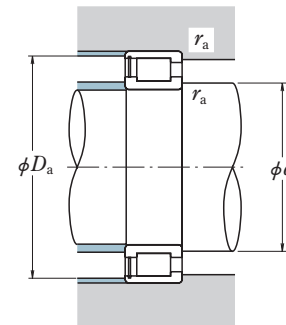
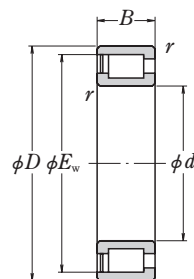

d	Boundary Dimensions (mm)				Basic Load Ratings (kN)		Bearing Designation
	D	B	r min.	E _W	C _r	C _{0r}	
100	140	24	1.1	130.5	132	209	NCF2920V
	150	37	1.5	139.7	209	310	NCF3020V
110	150	24	1.1	141	138	229	NCF2922V
	170	45	2	156.3	278	405	NCF3022V
120	165	27	1.1	154	177	305	NCF2924V
	180	46	2	167.58	293	440	NCF3024V
130	180	30	1.5	166.5	210	370	NCF2926V
	200	52	2	183.81	415	615	NCF3026V
140	190	30	1.5	179.4	227	395	NCF2928V
	210	53	2	197.82	435	680	NCF3028V
150	210	36	2	195	289	505	NCF2930V
	225	56	2.1	206.82	460	710	NCF3030V
160	220	36	2	207	310	535	NCF2932V
	240	60	2.1	224.8	520	810	NCF3032V
170	215	22	1.5	203.5	149	272	NCF1834V
	230	36	2	218	320	570	NCF2934V
	260	67	2.1	242.87	675	1 070	NCF3034V
180	225	22	1.5	215	154	290	NCF1836V
	250	42	2	231.5	390	695	NCF2936V
	280	74	2.1	260.3	785	1 260	NCF3036V
190	240	24	1.5	228.7	178	335	NCF1838V
	260	42	2	243.6	435	785	NCF2938V
	290	75	2.1	269.9	805	1 320	NCF3038V
200	250	24	1.5	237	182	350	NCF1840V
	280	48	2.1	261	530	955	NCF2940V
	310	82	2.1	287.8	910	1 510	NCF3040V
220	270	24	2	257.7	191	385	NCF1844V
	300	48	2.1	282	555	1 050	NCF2944V
	340	90	3	312.3	1 100	1 820	NCF3044V
240	300	28	2	283	236	470	NCF1848V
	320	48	2.1	303	580	1 140	NCF2948V
	360	92	3	335.25	1 160	1 990	NCF3048V
260	320	28	2	307	247	510	NCF1852V
	360	60	2.1	333.2	750	1 460	NCF2952V
	400	104	4	376.1	1 570	2 600	NCF3052V

Abutment and Fillet Dimensions (mm)			Mass (kg) approx.
d _a	D _a	r _a max.	
109	131	1	1.0
111	140	1.5	2.1
119	142	1	1.1
122	157	2	3.3
130	155	1	1.7
132	168	2	3.6
141	168	1.5	2.2
142	187	2	5.6
151	180	1.5	2.3
152	198	2	5.9
163	196	2	3.7
165	209	2	7.1
173	208	2	3.8
175	225	2	8.6
182	204	1.5	1.8
183	219	2	4.1
185	244	2	11.9
192	216	1.5	1.8
193	236	2	6.0
195	263	2	15.8
202	229	1.5	2.4
203	245	2	6.5
206	273	2	16.7
213	238	1.5	2.5
216	263	2	8.9
216	293	2	21.4
234	258	2	2.7
236	283	2	9.6
238	320	2.5	28.2
254	285	2	4.2
257	304	2	10.4
259	340	2.5	31.2
275	308	2	4.5
277	342	2	18.1
282	377	3	45.3

Remark Full complement cylindrical roller bearings are designed for specific applications; when using them, please contact NSK.

■ FULL COMPLEMENT CYLINDRICAL ROLLER BEARINGS

NCF Type, Single-Row

Bore Diameter 300 – 800 mm

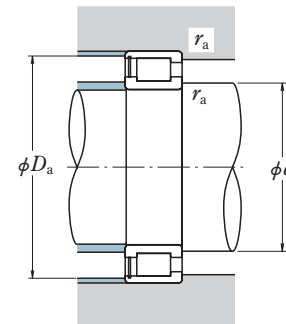
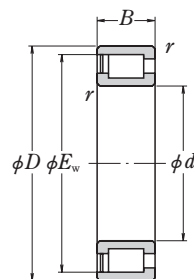

d	Boundary Dimensions (mm)				Basic Load Ratings (kN)		Bearing Designation
	D	B	r min.	E _W	C _r	C _{0r}	
300	380	38	2.5	359	445	870	NCF1860V
	420	72	3	389.6	1 120	2 200	NCF2960V
	460	118	4	431.7	1 980	3 500	NCF3060V
320	400	38	2.1	380	460	925	NCF1864V
	440	72	3	410	1 150	2 340	NCF2964V
	480	121	4	449.6	2 170	3 900	NCF3064V
340	420	38	2.1	401	475	985	NCF1868V
	460	72	3	430.3	1 190	2 470	NCF2968V
	520	133	5	485.8	2 480	4 350	NCF3068V
360	440	38	2.5	422	490	1 040	NCF1872V
	480	72	3	450.7	1 220	2 610	NCF2972V
	540	134	5	503.6	2 550	4 600	NCF3072V
380	480	46	2.5	452.8	575	1 230	NCF1876V
	520	82	4	486.7	1 600	3 350	NCF2976V
	560	135	5	521.4	2 610	4 800	NCF3076V
400	500	46	2.5	475.7	590	1 300	NCF1880V
	540	82	4	511	1 650	3 550	NCF2980V
	600	148	5	558.7	3 050	5 750	NCF3080AV
420	520	46	2.1	491	600	1 340	NCF1884V
	560	82	4	523.2	1 680	3 650	NCF2984V
	620	150	5	577.7	3 000	5 650	NCF3084V
440	540	46	2.1	514	615	1 410	NCF1888V
	600	95	4	562	2 070	4 300	NCF2988V
	580	56	3	552.7	920	1 950	NCF1892V
460	620	95	4	576.5	2 100	4 450	NCF2992V
	600	56	3	573	940	2 040	NCF1896V
	650	100	5	615	2 380	5 100	NCF2996V
500	620	56	3	593.5	960	2 120	NCF18/500V
	670	100	5	630.2	2 420	5 250	NCF29/500V
	650	56	3	624	990	2 240	NCF18/530V
530	680	56	3	654.7	1 020	2 360	NCF18/560V
	820	195	6	770	5 600	11 300	NCF30/560V
	730	60	3	695.5	1 140	2 680	NCF18/600V
600	800	118	5	752	3 050	7 300	NCF29/600V
	780	69	4	742	1 470	3 400	NCF18/630V
	820	69	4	780	1 520	3 550	NCF18/670V
670	870	74	4	832.5	1 650	3 900	NCF18/710V
750	920	78	5	882.3	1 930	4 600	NCF18/750V
800	980	82	5	936	2 110	5 100	NCF18/800V

Abutment and Fillet Dimensions (mm)			Mass (kg)
d _a	D _a	r _a max.	approx.
319	360	2	9.7
320	398	2.5	30.7
323	435	3	67.6
338	381	2	10.3
340	418	2.5	33
343	454	3	73
359	402	2	10.7
361	438	2.5	34.1
368	490	4	97
380	423	2	11.5
381	457	2.5	36
388	509	4	102
400	458	2	18.6
404	493	3	52
408	529	4	108
421	478	2	19.5
425	513	3	53.4
429	568	4	139
440	498	2	20.5
445	533	3	55.7
449	588	4	147
461	518	2	21.3
466	572	3	78.2
483	555	2.5	32.5
486	591	3	81.2
503	575	2.5	33.8
510	617	4	95.1
524	594	2.5	35
531	637	4	98.4
554	625	2.5	36.9
585	655	2.5	39.3
598	778	5	332.5
626	702	2.5	48.9
633	764	4	164.9
659	748	3	68.8
700	787	3	72.7
741	836	3	87.6
786	883	4	103.3
832	950	4	123.1

Remark Full complement cylindrical roller bearings are designed for specific applications; when using them, please contact NSK.

■ FULL COMPLEMENT CYLINDRICAL ROLLER BEARINGS

NNCF Type, Double-Row

Bore Diameter 100 – 260 mm

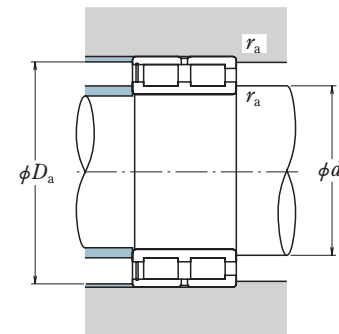
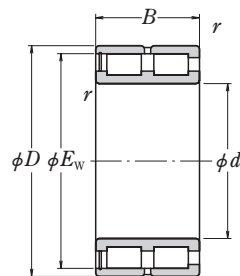

d	Boundary Dimensions (mm)				Basic Load Ratings (kN)		Bearing Designation
	D	B	r min.	E _w	C _r	C _{0r}	
100	140	40	1.1	129.8	194	400	NNCF4920V
	150	67	1.5	139.7	360	615	NNCF5020V
110	150	40	1.1	138.4	202	430	NNCF4922V
	170	80	2	156.3	490	840	NNCF5022V
120	165	45	1.1	153.8	226	480	NNCF4924V
	180	80	2	167.58	500	885	NNCF5024V
130	180	50	1.5	165.7	262	555	NNCF4926V
	200	95	2	183.81	710	1 230	NNCF5026V
140	190	50	1.5	176.2	272	595	NNCF4928V
	210	95	2	197.82	750	1 360	NNCF5028V
150	210	60	2	191.6	390	865	NNCF4930V
	225	100	2.1	206.82	785	1 420	NNCF5030V
160	220	60	2	204.1	410	930	NNCF4932V
	240	109	2.1	224.8	895	1 620	NNCF5032V
170	230	60	2	212.4	415	975	NNCF4934V
	260	122	2.1	242.87	1 160	2 140	NNCF5034V
180	250	69	2	230.5	550	1 230	NNCF4936V
	280	136	2.1	260.3	1 340	2 510	NNCF5036V
190	260	69	2	240.7	565	1 290	NNCF4938V
	290	136	2.1	269.9	1 380	2 630	NNCF5038V
200	250	50	1.5	235.9	320	825	NNCF4840V
	280	80	2.1	259.5	665	1 500	NNCF4940V
	310	150	2.1	287.75	1 560	3 000	NNCF5040V
220	270	50	1.5	256.9	340	905	NNCF4844V
	300	80	2.1	277	695	1 620	NNCF4944V
	340	160	3	312.3	1 890	3 650	NNCF5044V
240	300	60	2	282.6	495	1 340	NNCF4848V
	320	80	2.1	300	725	1 770	NNCF4948V
	360	160	3	335.25	1 990	4 000	NNCF5048V
260	320	60	2	303.6	515	1 450	NNCF4852V
	360	100	2.1	331.5	1 050	2 530	NNCF4952V
	400	190	4	376.1	2 690	5 200	NNCF5052V

Abutment and Fillet Dimensions (mm)			Mass (kg) approx.
d _a	D _a	r _a max.	
109	130	1	2.0
111	140	1.5	3.8
119	140	1	2.1
122	157	2	6.1
130	155	1	2.9
132	168	2	6.5
141	168	1.5	3.9
142	187	2	10.3
151	178	1.5	4.2
152	198	2	10.8
163	196	2	6.6
165	209	2	13
173	206	2	7.0
175	225	2	15.8
183	216	2	7.3
185	244	2	22.1
193	236	2	10.7
195	263	2	29.4
203	245	2	11.1
206	273	2	30.8
213	237	1.5	5.9
216	263	2	15.7
216	293	2	39.7
233	257	1.5	6.4
236	283	2	17
238	320	2.5	50.7
254	285	2	10.3
257	302	2	18.4
259	340	2.5	54.3
275	304	2	11
277	342	2	32
282	377	3	82.7

Remark Full complement cylindrical roller bearings are designed for specific applications; when using them, please contact NSK.

■ FULL COMPLEMENT CYLINDRICAL ROLLER BEARINGS

NNCF Type, Double-Row

Bore Diameter 280 – 500 mm

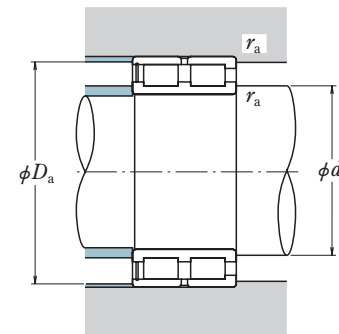
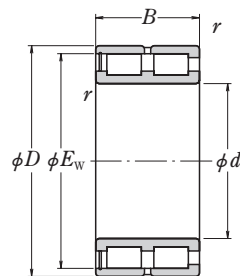

d	Boundary Dimensions (mm)				Basic Load Ratings (kN)		Bearing Designation
	D	B	r min.	E _W	C _r	C _{0r}	
280	350	69	2	332.5	685	1 860	NNCF4856V
	380	100	2.1	352.5	1 090	2 720	NNCF4956V
	420	190	4	390.5	2 770	5 450	NNCF5056V
300	380	80	2.1	357.2	805	2 160	NNCF4860V
	420	118	3	386.5	1 580	3 800	NNCF4960V
	460	218	4	431.7	3 400	7 000	NNCF5060V
320	400	80	2.1	380.2	835	2 310	NNCF4864V
	440	118	3	404.5	1 620	4 000	NNCF4964V
	480	218	4	446.9	3 500	7 350	NNCF5064V
340	420	80	2.1	397.4	855	2 430	NNCF4868V
	460	118	3	431	1 690	4 300	NNCF4968V
	520	243	5	485.8	4 250	8 750	NNCF5068V
360	440	80	2.1	420.4	885	2 580	NNCF4872V
	480	118	3	449	1 730	4 500	NNCF4972V
	540	243	5	503.6	4 350	9 150	NNCF5072V
380	480	100	2.1	450.6	1 260	3 600	NNCF4876V
	520	140	4	482.5	2 180	5 650	NNCF4976V
	560	243	5	521.4	4 500	9 600	NNCF5076V
400	500	100	2.1	471.7	1 290	3 750	NNCF4880V
	540	140	4	503	2 240	5 900	NNCF4980V
	600	272	5	558.7	5 050	10 900	NNCF5080V
420	520	100	2.1	492	1 320	3 950	NNCF4884V
	560	140	4	523	2 290	6 200	NNCF4984V
	620	272	5	577.7	5 150	11 300	NNCF5084V
440	540	100	2.1	513	1 350	4 150	NNCF4888V
	600	160	4	560.5	3 000	7 850	NNCF4988V
460	580	118	3	549.2	1 730	5 150	NNCF4892V
	620	160	4	573	3 050	8 050	NNCF4992V
480	600	118	3	565.8	1 760	5 300	NNCF4896V
	650	170	5	603	3 350	8 900	NNCF4996V
500	620	118	3	590.7	1 810	5 600	NNCF48/500V
	670	170	5	629	3 400	9 350	NNCF49/500V

Abutment and Fillet Dimensions (mm)			Mass (kg) approx.
d _a	D _a	r _a max.	
295	334	2	16
297	361	2	34
302	395	3	87.7
318	361	2	23
320	398	2.5	52
323	435	3	125
338	381	2	24.3
340	418	2.5	55
343	454	3	131
359	400	2	25.6
361	438	2.5	58
368	490	4	177
379	421	2	27
381	457	2.5	61
388	509	4	186
399	459	2	45.5
404	493	3	90.5
408	529	4	194
420	479	2	47.5
425	513	3	94.5
429	568	4	256
440	498	2	49.5
445	533	3	98.5
449	588	4	267
461	518	2	51.5
466	572	3	136
483	555	2.5	77.5
486	591	3	142
503	575	2.5	80.5
510	617	4	167
524	594	2.5	83.5
531	637	4	173

Remark Full complement cylindrical roller bearings are designed for specific applications; when using them, please contact NSK.

■ FULL COMPLEMENT CYLINDRICAL ROLLER BEARINGS FOR SHEAVES

RS-48 · RS-49 Types
 RSF-48 · RSF-49 Types
 Bore Diameter 50 – 220 mm

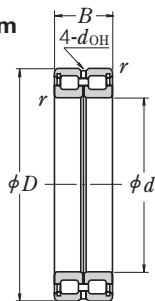

Fixed-End Bearing
RS

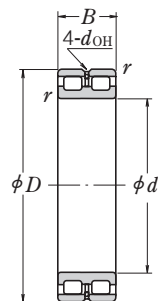

Free-End Bearing
RSF

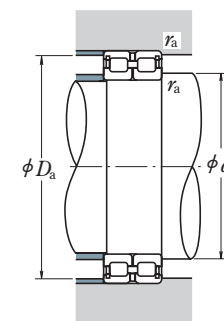

Boundary Dimensions (mm)				Basic Load Ratings (N)		Limiting Speeds (min ⁻¹)	
<i>d</i>	<i>D</i>	<i>B</i>	<i>r</i> min.	<i>C_r</i>	<i>C_{0r}</i>	Grease	Oil
50	72	22	0.6	48 000	75 500	2 000	4 000
60	85	25	1	68 500	118 000	1 600	3 200
65	90	25	1	70 500	125 000	1 600	3 200
70	100	30	1	102 000	168 000	1 400	2 800
80	110	30	1	109 000	191 000	1 300	2 600
90	125	35	1.1	147 000	268 000	1 100	2 200
100	125	25	1	87 500	189 000	1 100	2 200
	140	40	1.1	194 000	400 000	1 000	2 000
105	130	25	1	89 000	196 000	1 000	2 000
	145	40	1.1	199 000	420 000	950	1 900
110	140	30	1	114 000	260 000	950	1 900
	150	40	1.1	202 000	430 000	900	1 800
120	150	30	1	119 000	283 000	900	1 800
	165	45	1.1	226 000	480 000	800	1 600
130	165	35	1.1	162 000	390 000	800	1 600
	180	50	1.5	262 000	555 000	750	1 500
140	175	35	1.1	167 000	415 000	750	1 500
	190	50	1.5	272 000	595 000	710	1 400
150	190	40	1.1	235 000	575 000	670	1 400
	210	60	2	390 000	865 000	670	1 300
160	200	40	1.1	243 000	615 000	630	1 300
	220	60	2	410 000	930 000	600	1 200
170	215	45	1.1	265 000	650 000	600	1 200
	230	60	2	415 000	975 000	600	1 200
180	225	45	1.1	272 000	685 000	560	1 100
	250	69	2	495 000	1 130 000	530	1 100
190	240	50	1.5	315 000	785 000	530	1 100
	260	69	2	510 000	1 180 000	500	1 000
200	250	50	1.5	320 000	825 000	500	1 000
	280	80	2.1	665 000	1 500 000	480	950
220	270	50	1.5	340 000	905 000	450	900
	300	80	2.1	695 000	1 620 000	430	850

Remark Cylindrical roller bearings for sheaves are designed for specific applications; when using them, please contact NSK.

Bearing Designations ⁽¹⁾		Dimensions (mm)		Abutment and Fillet Dimensions (mm)			Mass (kg)
Fixed-End Bearing	Free-End Bearing	<i>d</i> _{OH} ⁽²⁾	Axial Disp. ⁽³⁾	<i>d</i> _a min.	<i>D</i> _a max.	<i>r</i> _a max.	approx.
RS-4910E4	RSF-4910E4	2.5	1.5	54	68	0.6	0.30
RS-4912E4	RSF-4912E4	2.5	1.5	65	80	1	0.46
RS-4913E4	RSF-4913E4	2.5	2	70	85	1	0.50
RS-4914E4	RSF-4914E4	3	2	75	95	1	0.79
RS-4916E4	RSF-4916E4	3	2	85	105	1	0.89
RS-4918E4	RSF-4918E4	3	2	96.5	118.5	1	1.35
RS-4820E4	RSF-4820E4	2.5	1.5	105	120	1	0.74
RS-4920E4	RSF-4920E4	3	2	106.5	133.5	1	1.97
RS-4821E4	RSF-4821E4	2.5	1.5	110	125	1	0.77
RS-4921E4	RSF-4921E4	3	2	111.5	138.5	1	2.05
RS-4822E4	RSF-4822E4	3	2	115	135	1	1.09
RS-4922E4	RSF-4922E4	3	2	116.5	143.5	1	2.15
RS-4824E4	RSF-4824E4	3	2	125	145	1	1.28
RS-4924E4	RSF-4924E4	4	3	126.5	158.5	1	2.95
RS-4826E4	RSF-4826E4	3	2	136.5	158.5	1	1.9
RS-4926E4	RSF-4926E4	5	3.5	138	172	1.5	3.95
RS-4828E4	RSF-4828E4	3	2	146.5	168.5	1	2.03
RS-4928E4	RSF-4928E4	5	3.5	148	182	1.5	4.25
RS-4830E4	RSF-4830E4	3	2	156.5	183.5	1	2.85
RS-4930E4	RSF-4930E4	5	3.5	159	201	2	6.65
RS-4832E4	RSF-4832E4	3	2	166.5	193.5	1	3.05
RS-4932E4	RSF-4932E4	5	3.5	169	211	2	7.0
RS-4834E4	RSF-4834E4	4	3	176.5	208.5	1	4.1
RS-4934E4	RSF-4934E4	4	3.5	179	221	2	7.35
RS-4836E4	RSF-4836E4	4	3	186.5	218.5	1	4.3
RS-4936E4	RSF-4936E4	6	4.5	189	241	2	10.7
RS-4838E4	RSF-4838E4	5	3.5	198	232	1.5	5.65
RS-4938E4	RSF-4938E4	6	4.5	199	251	2	11.1
RS-4840E4	RSF-4840E4	5	3.5	208	242	1.5	5.95
RS-4940E4	RSF-4940E4	7	5	211	269	2	15.7
RS-4844E4	RSF-4844E4	5	3.5	228	262	1.5	6.45
RS-4944E4	RSF-4944E4	7	5	231	289	2	17

Notes ⁽¹⁾ Suffix E4 indicates that the outer ring contains oil holes and an oil groove.

⁽²⁾ *d*_{OH} represents the oil hole diameter in the outer ring.

⁽³⁾ Axial Disp. refers to permissible axial displacement for free-end bearings.

■ FULL COMPLEMENT CYLINDRICAL ROLLER BEARINGS FOR SHEAVES

RS-48 · RS-49 Types

RSF-48 · RSF-49 Types

Bore Diameter 240 – 560 mm

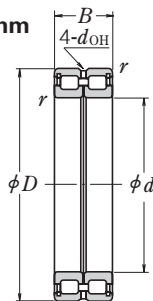

Fixed-End Bearing
RS

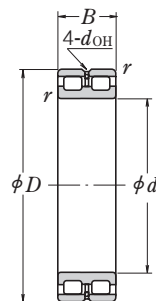

Free-End Bearing
RSF

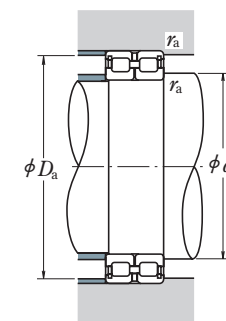

d	Boundary Dimensions (mm)			Basic Load Ratings (N)		Limiting Speeds (min ⁻¹)	
	D	B	r min.	C _r	C _{0r}	Grease	Oil
240	300	60	2	495 000	1 340 000	430	850
	320	80	2.1	725 000	1 770 000	400	800
260	320	60	2	515 000	1 450 000	380	750
	360	100	2.1	1 050 000	2 530 000	360	710
280	350	69	2	610 000	1 690 000	340	710
	380	100	2.1	1 090 000	2 720 000	340	670
300	380	80	2.1	805 000	2 160 000	320	630
	420	118	3	1 460 000	3 400 000	300	600
320	400	80	2.1	835 000	2 310 000	300	600
	440	118	3	1 500 000	3 600 000	280	560
340	420	80	2.1	855 000	2 430 000	280	560
	460	118	3	1 560 000	3 900 000	260	530
360	440	80	2.1	885 000	2 580 000	260	530
	480	118	3	1 600 000	4 050 000	260	500
380	480	100	2.1	1 260 000	3 600 000	240	500
	520	140	4	2 040 000	5 200 000	240	450
400	500	100	2.1	1 290 000	3 750 000	240	480
	540	140	4	2 100 000	5 450 000	220	450
420	520	100	2.1	1 320 000	3 950 000	220	450
	560	140	4	2 150 000	5 700 000	200	430
440	540	100	2.1	1 350 000	4 150 000	200	430
	600	160	4	2 840 000	7 350 000	190	380
460	580	118	3	1 730 000	5 150 000	190	380
	620	160	4	2 870 000	7 500 000	190	380
480	600	118	3	1 760 000	5 300 000	190	380
	650	170	5	3 200 000	8 500 000	180	360
500	620	118	3	1 810 000	5 600 000	180	360
	670	170	5	3 300 000	8 900 000	170	340
530	710	180	5	3 400 000	9 200 000	160	320
	750	190	5	3 800 000	10 100 000	150	300

Remark Cylindrical roller bearings for sheaves are designed for specific applications; when using them, please contact NSK.

Bearing Designations ⁽¹⁾		Dimensions (mm)		Abutment and Fillet Dimensions (mm)			Mass (kg) approx.
Fixed-End Bearing	Free-End Bearing	d _{OH} ⁽²⁾	Axial Disp. ⁽³⁾	d _a min.	D _a max.	r _a max.	
RS-4848E4	RSF-4848E4	5	3.5	249	291	2	10.3
RS-4948E4	RSF-4948E4	7	5	251	309	2	18.4
RS-4852E4	RSF-4852E4	5	3.5	269	311	2	11
RS-4952E4	RSF-4952E4	8	6	271	349	2	32
RS-4856E4	RSF-4856E4	6	4.5	289	341	2	16
RS-4956E4	RSF-4956E4	8	6	291	369	2	34
RS-4860E4	RSF-4860E4	6	5	311	369	2	23
RS-4960E4	RSF-4960E4	9	7	313	407	2.5	52
RS-4864E4	RSF-4864E4	6	5	331	389	2	24.3
RS-4964E4	RSF-4964E4	9	7	333	427	2.5	55
RS-4868E4	RSF-4868E4	6	5	351	409	2	25.6
RS-4968E4	RSF-4968E4	9	7	353	447	2.5	58
RS-4872E4	RSF-4872E4	6	5	371	429	2	27
RS-4972E4	RSF-4972E4	9	7	373	467	2.5	61
RS-4876E4	RSF-4876E4	8	6	391	469	2	45.5
RS-4976E4	RSF-4976E4	11	8	396	504	3	90.5
RS-4880E4	RSF-4880E4	8	6	411	489	2	47.5
RS-4980E4	RSF-4980E4	11	8	416	524	3	94.5
RS-4884E4	RSF-4884E4	8	6	431	509	2	49.5
RS-4984E4	RSF-4984E4	11	8	436	544	3	98.5
RS-4888E4	RSF-4888E4	8	6	451	529	2	51.5
RS-4988E4	RSF-4988E4	11	8	456	584	3	136
RS-4892E4	RSF-4892E4	9	7	473	567	2.5	77.5
RS-4992E4	RSF-4992E4	11	8	476	604	3	142
RS-4896E4	RSF-4896E4	9	7	493	587	2.5	80.5
RS-4996E4	RSF-4996E4	12	9	500	630	4	167
RS-48/500E4	RSF-48/500E4	9	7	513	607	2.5	83.5
RS-49/500E4	RSF-49/500E4	12	9	520	650	4	173
RS-49/530E4	RSF-49/530E4	12	11	550	690	4	206
RS-49/560E4	RSF-49/560E4	12	11	580	730	4	231

Notes ⁽¹⁾ Suffix E4 indicates that the outer ring contains oil holes and an oil groove.

⁽²⁾ d_{OH} represents the oil hole diameter in the outer ring.

⁽³⁾ Axial Disp. refers to permissible axial displacement for free-end bearings.

■ FULL COMPLEMENT CYLINDRICAL ROLLER BEARINGS FOR SHEAVES

RS-50 Type (Prelubricated)
Bore Diameter 40 – 400 mm

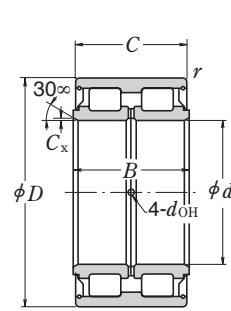

Without Locating Ring

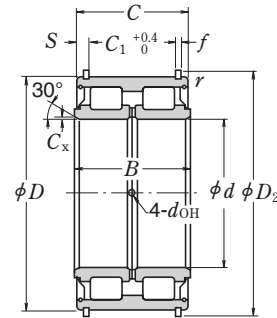

With Locating Ring

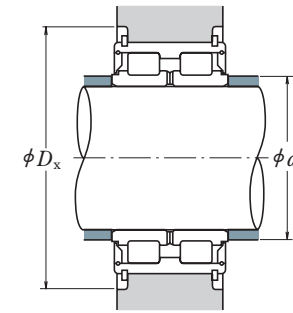

Boundary Dimensions (mm)						Basic Load Ratings (N)		Limiting Speeds (min ⁻¹) Grease
<i>d</i>	<i>D</i>	<i>B</i>	<i>C</i>	<i>C_x</i> ⁽¹⁾ min.	<i>r</i> min.	<i>C_r</i>	<i>C_{0r}</i>	
40	68	38	37	0.4	0.6	79 500	116 000	2 400
45	75	40	39	0.4	0.6	95 500	144 000	2 200
50	80	40	39	0.4	0.6	100 000	158 000	2 000
55	90	46	45	0.6	0.6	118 000	193 000	1 800
60	95	46	45	0.6	0.6	123 000	208 000	1 700
65	100	46	45	0.6	0.6	128 000	224 000	1 600
70	110	54	53	0.6	0.6	171 000	285 000	1 400
75	115	54	53	0.6	0.6	179 000	305 000	1 400
80	125	60	59	0.6	0.6	251 000	430 000	1 200
85	130	60	59	0.6	0.6	256 000	445 000	1 200
90	140	67	66	1	0.6	305 000	540 000	1 100
95	145	67	66	1	0.6	310 000	565 000	1 100
100	150	67	66	1	0.6	320 000	585 000	1 000
110	170	80	79	1.1	1	385 000	695 000	900
120	180	80	79	1.1	1	400 000	750 000	850
130	200	95	94	1.1	1	535 000	1 000 000	750
140	210	95	94	1.1	1	550 000	1 040 000	710
150	225	100	99	1.3	1	620 000	1 210 000	670
160	240	109	108	1.3	1.1	695 000	1 370 000	630
170	260	122	121	1.3	1.1	860 000	1 680 000	600
180	280	136	135	1.3	1.1	980 000	1 910 000	530
190	290	136	135	1.3	1.1	1 120 000	2 230 000	500
200	310	150	149	1.3	1.1	1 310 000	2 650 000	480
220	340	160	159	1.5	1.1	1 510 000	3 100 000	430
240	360	160	159	1.5	1.1	1 570 000	3 350 000	400
260	400	190	189	2	1.5	2 130 000	4 500 000	360
280	420	190	189	2	1.5	2 170 000	4 700 000	340
300	460	218	216	2	1.5	2 670 000	5 850 000	300
320	480	218	216	2	1.5	2 720 000	6 100 000	300
340	520	243	241	2.1	2	3 350 000	7 550 000	260
360	540	243	241	2.1	2	3 450 000	7 850 000	260
380	560	243	241	2.1	2	3 550 000	8 400 000	240
400	600	272	270	2.1	2	4 250 000	9 950 000	220

Note ⁽¹⁾ These values represent chamfer dimensions of the inner ring in the radial direction.

- Remarks 1. Quality grease is prepacked in the bearings.
2. Grease can be supplied through oil holes in the inner rings.

Bearing Designations		Locating Ring Dimensions (mm)				Oil Holes (mm) <i>d_{OH}</i>	Abutment and Fillet Dimensions (mm)		Mass (kg) approx.
Without Locating Ring	With Locating Ring	<i>C₁</i>	<i>S</i>	<i>D₂</i>	<i>f</i>		<i>d_a</i> min.	<i>D_x</i> min.	
RS-5008	RS-5008NR	28	4.5	71.8	2	2.5	43.5	77.5	0.56
RS-5009	RS-5009NR	30	4.5	78.8	2	2.5	48.5	84.5	0.70
RS-5010	RS-5010NR	30	4.5	83.8	2	2.5	53.5	89.5	0.76
RS-5011	RS-5011NR	34	5.5	94.8	2.5	3	60	101	1.17
RS-5012	RS-5012NR	34	5.5	99.8	2.5	3	65	106	1.25
RS-5013	RS-5013NR	34	5.5	104.8	2.5	3	70	111	1.32
RS-5014	RS-5014NR	42	5.5	114.5	2.5	3	75	121	1.87
RS-5015	RS-5015NR	42	5.5	119.5	2.5	3	80	126	2.0
RS-5016	RS-5016NR	48	5.5	129.5	2.5	3	85	136	2.65
RS-5017	RS-5017NR	48	5.5	134.5	2.5	3	90	141	2.75
RS-5018	RS-5018NR	54	6	145.4	2.5	4	96	153.5	3.75
RS-5019	RS-5019NR	54	6	150.4	2.5	4	101	158.5	3.95
RS-5020	RS-5020NR	54	6	155.4	2.5	4	106	163.5	4.05
RS-5022	RS-5022NR	65	7	175.4	2.5	5	116.5	183.5	6.1
RS-5024	RS-5024NR	65	7	188	3	5	126.5	197	7.0
RS-5026	RS-5026NR	77	8.5	207	3	5	136.5	217	10.6
RS-5028	RS-5028NR	77	8.5	217	3	5	146.5	227	11.3
RS-5030	RS-5030NR	81	9	232	3	6	157	242	13.7
RS-5032	RS-5032NR	89	9.5	247	3	6	167	257	16.8
RS-5034	RS-5034NR	99	11	270	4	6	177	285	22.2
RS-5036	RS-5036NR	110	12.5	294	5	6	187	318	30
RS-5038	RS-5038NR	110	12.5	304	5	6	197	328	32
RS-5040	RS-5040NR	120	14.5	324	5	6	207	352	41
RS-5044	RS-5044NR	130	14.5	356	6	7	228.5	382	53
RS-5048	RS-5048NR	130	14.5	376	6	7	248.5	402	57
RS-5052	RS-5052NR	154	17.5	416	7	8	270	444	86
RS-5056	RS-5056NR	154	17.5	436	7	8	290	472	92
RS-5060	RS-5060NR	178	19	476	7	8	310	512	130
RS-5064	—	—	—	—	—	8	330	—	135
RS-5068	—	—	—	—	—	10	352	—	185
RS-5072	—	—	—	—	—	10	372	—	192
RS-5076	—	—	—	—	—	10	392	—	196
RS-5080	—	—	—	—	—	10	412	—	280

- Remarks 3. Cylindrical roller bearings for sheaves are designed for specific applications; when using them, please contact NSK.
4. For shields with outside diameters larger than 180 mm, the above figure is different from the actual shape. For detailed drawings, please contact NSK.

6. TAPERED ROLLER BEARINGS

INTRODUCTION C 182

TECHNICAL DATA

Free Space of Tapered Roller Bearings C 188

BEARING TABLES

METRIC SERIES TAPERED ROLLER BEARINGS

Bore Diameter 15 – 100 mm C 190

Bore Diameter 105 – 240 mm C 202

Bore Diameter 260 – 440 mm C 208

INCH SERIES TAPERED ROLLER BEARINGS

Bore Diameter 12.000 – 47.625 mm C 210

Bore Diameter 48.412 – 69.850 mm C 224

Bore Diameter 70.000 – 206.375 mm C 232

Appendix 14 (Page E020) contains the index for inch series tapered roller bearings.

DOUBLE-ROW TAPERED ROLLER BEARINGS

Bore Diameter 40 – 260 mm C 246



DESIGN, TYPES, AND FEATURES

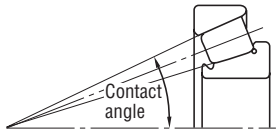

Tapered roller bearings are designed so the apices of the cones formed by the raceways of the inner and outer rings and the inner ring rollers all coincide at one point on the axis of the bearing. When a radial load is imposed, a component axial force occurs; therefore, it is necessary to use two bearings in opposition or some other multiple-bearing arrangement.

For Metric Series medium-angle or steep-angle tapered roller bearings, the respective contact angle designation C or D is added after the bore number. For normal-angle tapered roller bearings, no contact angle designation is used. Medium-angle tapered roller bearings are primarily used for the pinion shafts of differential gears in automobiles.

Some bearings with high load capacity (HR Series) contain a J suffix that indicates they conform to ISO specifications for outer ring back face raceway diameter, outer ring width, and contact angle. Therefore, the inner ring assembly and outer ring of bearings with a J suffix are internationally interchangeable.

Some Metric Series tapered roller bearings specified by ISO 355 have different dimensions from past Series 3XX bearings. Some of these are listed in the bearing tables. These conform to ISO specifications for the small-end diameter of the inner ring and contact angle. The inner and outer ring assemblies are internationally interchangeable. The bearing designation structure, which has changed from the past, is listed below:

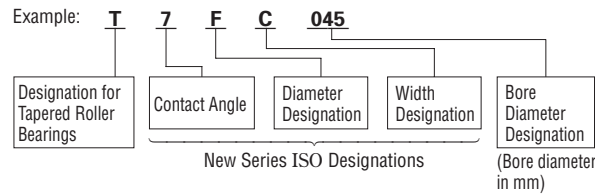

Inch Series bearings also exist. Inner ring assemblies and outer rings are approximately formulated as follows (excluding four-row tapered roller bearings):

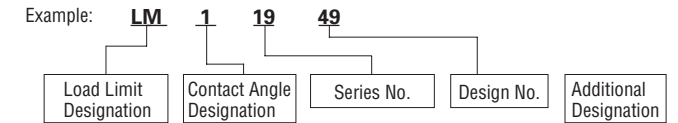

Various arrangements of tapered roller bearings (excluding single-row bearings) are available.

The cages of tapered roller bearings are usually made of pressed steel.

Table 1 Design and Features of Tapered Roller Bearing Arrangements

Design	Arrangement	Ex. Bearing Designation	Features
	Back-to-back	HR30210JDB+KLR10	Two standard bearings are combined. The bearing clearances are adjusted by inner ring spacers or outer ring spacers. The inner rings, outer rings, and spacers are marked with serial numbers and mating marks. Components with the same serial number can be assembled by referring to the matching indications.
	Face-to-face	HR30210JDF+KR	
	KBE Type	100KBE31+L	The KBE type is a back-to-back arrangement of bearings with an integrated outer ring spacer. The KH type is a face-to-face arrangement in which the inner rings are integrated. Since the bearing clearance is adjusted using spacers, components must have the same serial number for assembly with reference to the matching indications.
	KH Type	110KH31+K	

TOLERANCES AND RUNNING ACCURACY

METRIC SERIES TAPERED ROLLER BEARINGS Table 7.3 (Pages A132 to A135)

INCH SERIES TAPERED ROLLER BEARINGS Table 7.4 (Pages A136 and A137)

The following precision classes apply to some Inch Series tapered roller bearings. For more details, please consult with NSK.

(1) J line bearings (bearings preceded by ▲ in the bearing tables)

Table 2 Tolerances for Inner Rings (CLASS K)

Units : m

Nominal Bore Diameter d (mm)		Δd_{mp}		V_{dp}	V_{dmp}	K_{ia}
over	incl.	high	low	max.	max.	max.
10	18	0	-12	12	9	15
18	30	0	-12	12	9	18
30	50	0	-12	12	9	20
50	80	0	-15	15	11	25
80	120	0	-20	20	15	30
120	180	0	-25	25	19	35
180	250	0	-30	30	23	50
250	315	0	-35	35	26	60
315	400	0	-40	40	30	70

Table 3 Tolerances for Outer Rings (CLASS K)

Units : m

Nominal Outside Diameter D (mm)		ΔD_{mp}		V_{Dp}	V_{Dmp}	K_{ea}
over	incl.	high	low	max.	max.	max.
18	30	0	-12	12	9	18
30	50	0	-14	14	11	20
50	80	0	-16	16	12	25
80	120	0	-18	18	14	35
120	150	0	-20	20	15	40
150	180	0	-25	25	19	45
180	250	0	-30	30	23	50
250	315	0	-35	35	26	60
315	400	0	-40	40	30	70
400	500	0	-45	45	34	80

Table 4 Deviations of Actual Bearing Width and Actual Effective Widths of Inner Subunit and Outer Ring (CLASS K)

Units : m

Nominal Bore Diameter d (mm)		Deviation of Actual Effective Width of Inner Subunit ΔT_{1s}		Deviation of Actual Effective Width of Outer Ring ΔT_{2s}		Deviation of Actual Bearing Width ΔT_s	
over	incl.	high	low	high	low	high	low
10	80	+100	0	+100	0	+200	0
80	120	+100	-100	+100	-100	+200	-200
120	315	+150	-150	+200	-100	+350	-250
315	400	+200	-200	+200	-200	+400	-400

(2) Bearings for Front Axles of Automobiles
(In the bearing tables, these are preceded by "T")

Table 5 Tolerances for Deviations of a Single Bore Diameter and Actual Bearing Width

Units : m

Nominal Bore Diameter d			Deviation of a Single Bore Diameter Δd_s		Deviation of Actual Bearing Width ΔT_s	
over (mm)	incl. 1/25.4	incl. (mm)	high	low	high	low
—	76.200	3.0000	+20	0	+356	0

The tolerances for outside diameter and those for radial runout of the inner rings and outer rings conform to Table 7.4.2 (Pages A136 and A137).

(3) Special Chamfer Dimensions

For bearings marked "spec." in the r column of the bearing tables have inner ring back-face side dimensions as shown in the following figure:

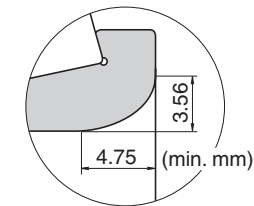

■ TAPERED ROLLER BEARINGS**RECOMMENDED FITS**

METRIC SERIES TAPERED ROLLER BEARINGS Table 8.3 (Page A164)
Table 8.5 (Page A165)

INCH SERIES TAPERED ROLLER BEARINGS Table 8.7 (Page A166)
Table 8.8 (Page A167)

INTERNAL CLEARANCE

**METRIC SERIES TAPERED ROLLER BEARINGS
(Matched and Double-Row)** Table 8.17 (Page A173)

**INCH SERIES TAPERED ROLLER BEARINGS
(Matched and Double-Row)** Table 8.17 (Page A173)

DIMENSIONS RELATED TO MOUNTING

The dimensions related to mounting tapered roller bearings are listed in the bearing tables. Since the cages protrude from the ring faces of tapered roller bearings, please use care when designing shafts and housings.

When heavy axial loads are imposed, the shaft shoulder dimensions and strength must be sufficient to support the inner ring rib.

PERMISSIBLE MISALIGNMENT

The permissible misalignment angle for tapered roller bearings is approximately 0.0009 radian (3').

LIMITING SPEEDS (GREASE/OIL)

The limiting speeds (grease) and limiting speeds (oil) listed in the bearing tables should be adjusted depending on bearing load conditions. Furthermore, higher speeds are attainable by making changes in the lubrication method, cage design, etc. Refer to page A098 for more detailed information.

PRECAUTIONS FOR USE OF TAPERED ROLLER BEARINGS

1. If the load on tapered roller bearings becomes too small, or if the ratio of the axial and radial loads for matched bearings during operation exceeds ' e ' as listed in the bearing tables, slippage between the rollers and raceways occurs, which may result in smearing. This is especially prevalent with large bearings since the weight of the rollers and cage is high. If such load conditions are expected, please contact NSK for selection of the bearings.
2. Confirm the dimensions of D_a , D_b , S_a , and S_b when adopting HR Series bearings.

TECHNICAL DATA

Free Space of Tapered Roller Bearings

Tapered roller bearings can carry radial loads and unidirectional axial loads and offer high capacity. These bearings are used widely in machines with relatively severe loading conditions, usually in various combinations of opposed or combined single-row bearings.

Tapered roller bearings are usually lubricated with grease to facilitate easier maintenance and inspection. Be sure to select a grease appropriate for operating conditions and use the proper amount of grease in the housing space. The necessary free space for various bearing Series are listed in Table 6.

The free space of a tapered roller bearing is measured as the outer volume of the bearing less the inner ring, outer ring, and cage, as shown in Figure 1. The bearing is filled so that grease reaches the inner ring rib surface and pocket surface sufficiently. Take care regarding the fill amount and state of the grease, especially if grease leakage occurs or if maintaining low running torque is important.

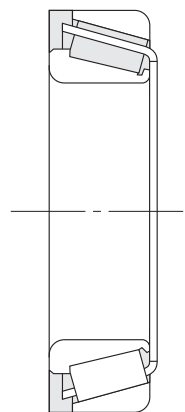

Fig. 1 Free Space in a Tapered Roller Bearing

Table 6 Free Space of Tapered Roller Bearings

Units: cm³

Bearing Bore No.	Bearing Free Space									
	Bearing Series									
	HR329-J	HR320-XJ	HR330-J	HR331-J	HR302-J	HR322-J	HR332-J	HR303-J	HR303-DJ	HR323-J
02	—	—	—	—	—	—	—	4.5	—	—
03	—	—	—	—	3.3	4.3	—	5.7	—	—
04	—	3.5	—	—	5.3	6.6	—	7.2	—	9.2
/22	—	3.6	—	—	—	7.3	—	9.1	—	—
05	—	3.7	4.3	—	6.3	7.4	7.5	11	13	15
/28	—	5.3	—	—	8.8	9.8	10	16	—	—
06	—	6.2	6.7	—	9.2	11	12	18	21	23
/32	—	6.6	—	—	11	13	14	20	—	—
07	4.0	7.5	8.9	—	13	17	18	23	26	35
08	5.8	9.1	11	—	18	23	25	31	35	45
09	—	11	—	18	22	24	26	41	48	58
10	—	12	15	20	23	26	29	55	59	77
11	8.8	19	21	29	30	36	40	72	78	99
12	9.0	20	23	—	39	47	53	88	95	130
13	—	21	25	—	45	62	65	110	120	150
14	17	29	33	—	53	67	69	130	150	190
15	—	30	34	—	58	73	74	160	180	230
16	—	40	—	—	75	91	100	200	200	270
17	—	43	49	76	92	120	130	230	250	320
18	28	58	—	110	110	150	—	260	310	370
19	29	60	—	—	140	170	—	310	350	430
20	37	64	—	150	160	210	240	380	460	580

■ SINGLE-ROW TAPERED ROLLER BEARINGS

Bore Diameter 15 – 28 mm

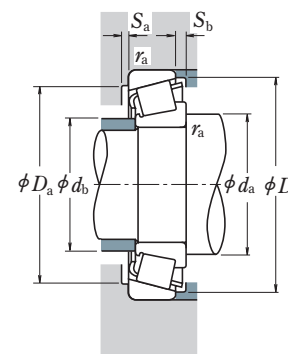
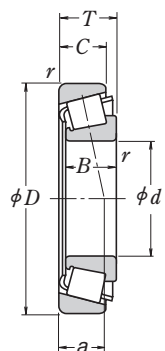
**Dynamic Equivalent Load**

$$P = XF_r + YF_a$$

$F_a/F_r \leq e$		$F_a/F_r > e$	
X	Y	X	Y
1	0	0.4	Y_1

Static Equivalent Load

$$P_0 = 0.5F_r + Y_0F_a$$

When $F_r > 0.5F_r + Y_0F_a$, use $P_0 = F_r$ The values of e , Y_1 , and Y_0 are given in the table below.

d	Boundary Dimensions (mm)				Ring: Inner Outer r min.	Basic Load Ratings (N)		Limiting Speeds (min ⁻¹)		Bearing Designation	ISO355 Dimension Series approx.	Abutment and Fillet Dimensions (mm)						Eff. Load Center (mm) a	Constant e	Axial Load Factors		Mass (kg) approx.				
	D	T	B	C		C _r	C _{0r}	Grease	Oil			d _a min.	d _b max.	D _a max.	D _b min.	S _a min.	S _b min.			Ring: Inner Outer r _a max.	Y ₁		Y ₀			
15	35	11.75	11	10	0.6	0.6	14 800	13 200	11 000	15 000	30202	—	23	19	30	30	33	2	1.5	0.6	0.6	8.2	0.32	1.9	1.0	0.053
	42	14.25	13	11	1	1	23 600	21 100	9 500	13 000	HR 30302 J	2FB	24	22	36	36	38.5	2	3	1	1	9.5	0.29	2.1	1.2	0.098
17	40	13.25	12	11	1	1	20 100	19 900	9 500	13 000	HR 30203 J	2DB	26	23	34	34	37.5	2	2	1	1	9.7	0.35	1.7	0.96	0.079
	40	17.25	16	14	1	1	27 100	28 000	9 500	13 000	HR 32203 J	2DD	26	22	34	34	37	2	3	1	1	11.2	0.31	1.9	1.1	0.103
	47	15.25	14	12	1	1	29 200	26 700	8 500	12 000	HR 30303 J	2FB	26	24	41	40	43	2	3	1	1	10.4	0.29	2.1	1.2	0.134
	47	15.25	14	10.5	1	1	22 000	20 300	8 000	11 000	30303 D	—	29	23	41	34	44	2	4.5	1	1	15.4	0.81	0.74	0.41	0.129
20	47	20.25	19	16	1	1	37 500	36 500	8 500	11 000	HR 32303 J	2FD	28	23	41	39	43	2	4	1	1	12.5	0.29	2.1	1.2	0.178
	42	15	15	12	0.6	0.6	24 600	27 400	9 000	12 000	HR 32004 XJ	3CC	28	24	37	35	40	3	3	0.6	0.6	10.6	0.37	1.6	0.88	0.097
	47	15.25	14	12	1	1	27 900	28 500	8 000	11 000	HR 30204 J	2DB	29	27	41	40	44	2	3	1	1	11.0	0.35	1.7	0.96	0.127
	47	15.25	14	12	0.3	1	23 900	24 000	8 000	11 000	HR 30204 C-A-	—	29	26	41	37	44	2	3	0.3	1	13.0	0.55	1.1	0.60	0.126
	47	19.25	18	15	1	1	35 500	37 500	8 500	11 000	HR 32204 J	2DD	29	25	41	38	44.5	3	4	1	1	12.6	0.33	1.8	1.0	0.161
22	47	19.25	18	15	1	1	31 500	33 500	8 000	11 000	HR 32204 CJ	5DD	29	25	41	36	44	2	4	1	1	14.5	0.52	1.2	0.64	0.166
	52	16.25	15	13	1.5	1.5	35 000	33 500	7 500	10 000	HR 30304 J	2FB	31	27	44	44	47.5	2	3	1.5	1.5	11.6	0.30	2.0	1.1	0.172
	52	16.25	15	12	1.5	1.5	25 300	24 500	7 100	10 000	30304 D	—	34	26	43	37	49	2	4	1.5	1.5	16.7	0.81	0.74	0.41	0.168
	52	22.25	21	18	1.5	1.5	45 500	47 500	8 000	11 000	HR 32304 J	2FD	33	26	43	42	48	3	4	1.5	1.5	13.9	0.30	2.0	1.1	0.241
	44	15	15	11.5	0.6	0.6	25 600	29 400	8 500	11 000	HR 320/22 XJ	3CC	30	27	39	37	42	3	3.5	0.6	0.6	11.1	0.40	1.5	0.83	0.103
	50	15.25	14	12	1	1	29 200	30 500	7 500	10 000	HR 302/22	—	31	29	44	42	47	2	3	1	1	11.6	0.37	1.6	0.90	0.139
	50	15.25	14	12	1	1	27 200	29 500	7 500	10 000	HR 302/22 C	—	31	29	44	40	47	2	3	1	1	13.0	0.49	1.2	0.67	0.144
	50	19.25	18	15	1	1	36 500	40 500	7 500	11 000	HR 322/22	—	31	28	44	41	47	2	4	1	1	13.5	0.37	1.6	0.89	0.18
	50	19.25	18	15	1	1	33 500	39 500	7 500	10 000	HR 322/22 C	—	31	29	44	39	48	2	4	1	1	15.2	0.51	1.2	0.65	0.185
	56	17.25	16	14	1.5	1.5	37 000	36 500	7 100	9 500	HR 303/22	—	33	30	47	46	50	2	3	1.5	1.5	12.4	0.32	1.9	1.0	0.208
25	56	17.25	16	13	1.5	1.5	34 500	34 000	6 700	9 500	HR 303/22 C	—	33	30	47	44	52.5	3	4	1.5	1.5	15.9	0.59	1.0	0.56	0.207
	47	15	15	11.5	0.6	0.6	27 400	33 000	8 000	11 000	HR 32005 XJ	4CC	33	30	42	40	45	3	3.5	0.6	0.6	11.8	0.43	1.4	0.77	0.116
	47	17	17	14	0.6	0.6	31 000	38 000	8 000	11 000	HR 33005 J	2CE	33	29	42	41	44	3	3	0.6	0.6	11.0	0.29	2.1	1.1	0.131
	52	16.25	15	13	1	1	32 000	35 000	7 100	10 000	HR 30205 J	3CC	34	31	46	44	48.5	2	3	1	1	12.7	0.37	1.6	0.88	0.157
	52	16.25	15	12	1	1	28 100	31 500	9 700	9 500	HR 30205 C	—	34	32	46	43	49.5	2	4	1	1	14.4	0.53	1.1	0.62	0.155
	52	19.25	18	16	1	1	40 000	45 000	7 100	10 000	HR 32205 J	2CD	34	30	46	44	50	2	3	1	1	13.5	0.36	1.7	0.92	0.189
	52	19.25	18	15	1	1	35 000	42 000	7 100	9 500	HR 32205 C	—	34	30	46	40	50	2	4	1	1	15.8	0.53	1.1	0.62	0.19
	52	22	22	18	1	1	47 500	56 500	7 500	10 000	HR 33205 J	2DE	34	29	46	43	49.5	4	4	1	1	14.1	0.35	1.7	0.94	0.221
	62	18.25	17	15	1.5	1.5	47 500	46 000	6 300	8 500	HR 30305 J	2FB	36	34	54	54	57	2	3	1.5	1.5	13.2	0.30	2.0	1.1	0.27
	62	18.25	17	14	1.5	1.5	42 000	45 000	6 000	8 500	HR 30305 C	—	36	35	53	49	58.5	3	4	1.5	1.5	16.4	0.55	1.1	0.60	0.276
	62	18.25	17	13	1.5	1.5	38 000	40 500	5 600	8 000	HR 30305 DJ	(7FB)	39	34	53	47	59	2	5	1.5	1.5	19.9	0.83	0.73	0.40	0.265
	62	18.25	17	13	1.5	1.5	38 000	40 500	5 600	8 000	HR 31305 J	7FB	39	33	53	47	59	3	5	1.5	1.5	19.9	0.83	0.73	0.40	0.265
	62	25.25	24	20	1.5	1.5	62 500	66 000	6 300	8 500	HR 32305 J	2FD	38	32	53	51	57	3	5	1.5	1.5	15.6	0.30	2.0	1.1	0.376
28	52	16	16	12	1	1	32 000	39 000	7 100	9 500	HR 320/28 XJ	4CC	37	33	46	44	50	3	4	1	1	12.8	0.43	1.4	0.77	0.146
	58	17.25	16	14	1	1	39 500	41 500	6 300	9 000	HR 302/28	—	37	34	52	50	55	2	3	1	1	13.2	0.35	1.7	0.93	0.203
	58	17.25	16	12	1	1	34 000	38 500	6 300	8 500	HR 302/28 C	—	37	34	52	48	54	2	5	1	1	16.9	0.64	0.94	0.52	0.198
	58	20.25	19	16	1	1	47 500	54 000	6 300	9 000	HR 322/28	—	37	34	52	49	55	2	4	1	1	14.6	0.37	1.6	0.89	0.243
	58	20.25	19	16	1	1	42 000	49 500	6 300	9 000	HR 322/28 CJ	5DD	37	33	52	45	55	2	4	1	1	16.8	0.56	1.1	0.59	0.251
	68	19.75	18	15	1.5	1.5	55 000	55 500	6 000	8 000	HR 303/28	—	39	37	59	58	61	2	4.5	1.5	1.5	14.5	0.31	1.9	1.1	0.341
	68	19.75	18	14	1.5	1.5	49 500	50 500	5 600	7 500	HR 303/28 C	—	39	38	59	57	63	3	5.5	1.5	1.5	17.4	0.52	1.2	0.64	0.335

Remark Suffix C represents medium-angle tapered roller bearings. Since they are designed for specific applications, please consult NSK when using bearings with suffix C.

SINGLE-ROW TAPERED ROLLER BEARINGS

Bore Diameter 30 – 35 mm

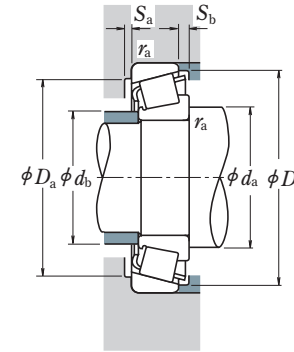
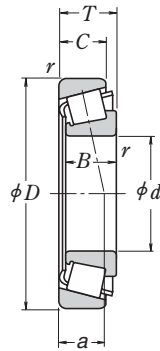

Dynamic Equivalent Load

$$P = XF_r + YF_a$$

$F_a/F_r \leq e$		$F_a/F_r > e$	
X	Y	X	Y
1	0	0.4	Y_1

Static Equivalent Load

$$P_0 = 0.5F_r + Y_0F_a$$

When $F_r > 0.5F_r + Y_0F_a$, use $P_0 = F_r$

The values of e , Y_1 , and Y_0 are given in the table below.

Boundary Dimensions (mm)					Ring:		Basic Load Ratings (N)		Limiting Speeds (min ⁻¹)		Bearing Designation	ISO355 Dimension Series approx.	Abutment and Fillet Dimensions (mm)						Ring: Inner Outer r_a max.	Eff. Load Center (mm) a	Constant e	Axial Load Factors		Mass (kg) approx.			
d	D	T	B	C	Inner	Outer	C_r	C_{0r}	Grease	Oil			d_a min.	d_b max.	D_a max.	D_b min.	S_a min.	S_b min.				r_a min.	r_a max.		Y_1	Y_0	
30	47	12	12	9	0.3	0.3	17 600	24 400	7 500	10 000	HR 32906 J HR 32006 XJ HR 33006 J	2BD	34	34	44	42	44	3	3	0.3	0.3	9.2	0.32	1.9	1.0	0.074	
	55	17	17	13	1	1	36 000	44 500	6 700	9 000		4CC	39	35	49	47	53	3	4	1	1	13.5	0.43	1.4	0.77	0.172	
	55	20	20	16	1	1	42 000	54 000	6 700	9 000		2CE	39	35	49	48	52	3	4	1	1	13.1	0.29	2.1	1.1	0.208	
	62	17.25	16	14	1	1	43 000	47 500	6 000	8 000	HR 30206 J HR 30206 C HR 32206 J	3DB	39	37	56	52	58	2	3	1	1	13.9	0.37	1.6	0.88	0.238	
		17.25	16	12	1	1	35 500	37 000	5 600	7 500		—	39	36	56	49	59	2	5	1	1	17.8	0.68	0.88	0.49	0.221	
		21.25	20	17	1	1	52 000	60 000	6 000	8 500		3DC	39	36	56	51	58.5	2	4	1	1	15.4	0.37	1.6	0.88	0.297	
		62	21.25	20	16	1	1	48 000	56 000	6 000	8 000	HR 32206 C HR 32006 J HR 30306 J HR 30306 C	—	39	35	56	48	59	2	5	1	1	17.8	0.55	1.1	0.60	0.293
			25	19.5	1	1	66 500	79 500	6 000	8 000	2DE		39	35	56	52	59.5	5	5.5	1	1	16.1	0.34	1.8	0.97	0.355	
			20.75	19	16	1.5	1.5	59 500	60 000	5 300	7 500		2FB	41	40	63	62	66	3	4.5	1.5	1.5	15.1	0.32	1.9	1.1	0.403
	20.75		19	14	1.5	1.5	56 500	55 500	5 300	7 100	—		41	38	63	59	67	3	6.5	1.5	1.5	18.5	0.55	1.1	0.60	0.383	
	72	20.75	19	14	1.5	1.5	49 000	52 500	4 800	6 700	HR 30306 DJ HR 30306 J HR 32306 J HR 32306 CJ	(7FB)	44	40	63	55	68	3	6.5	1.5	1.5	23.1	0.83	0.73	0.40	0.393	
		20.75	19	14	1.5	1.5	49 000	52 500	4 800	6 800		7FB	44	40	63	55	68	3	6.5	1.5	1.5	23.1	0.83	0.73	0.40	0.393	
28.75		27	23	1.5	1.5	80 000	88 500	5 600	7 500	2FD		43	38	63	59	66	3	5.5	1.5	1.5	18.0	0.32	1.9	1.1	0.57		
28.75		27	23	1.5	1.5	76 000	86 500	5 600	7 500	5FD		43	36	63	54	68	3	5.5	1.5	1.5	22.0	0.55	1.1	0.60	0.583		
32		17	17	13	1	1	37 500	47 000	6 300	8 500		HR 320/32 XJ 330/32 HR 302/32 HR 302/32 C	4CC	41	37	52	49	55	3	4	1	1	14.2	0.45	1.3	0.73	0.191
		21	20	16	1	1	41 000	50 000	6 300	8 500			—	41	37	52	50	55	2	4	1	1	13.8	0.31	1.9	1.1	0.225
	18.25	17	15	1	1	48 500	54 000	5 600	8 000	—	41		39	59	56	61	3	3	1	1	14.7	0.37	1.6	0.88	0.277		
	18.25	17	14	1	1	45 500	52 500	5 600	7 500	—	41		39	59	54	62	3	4	1	1	16.9	0.55	1.1	0.60	0.273		
65	22.25	21	18	1	1	56 000	65 000	6 000	8 000	HR 322/32 HR 322/32 C HR 332/32 J 303/32	—	41	38	59	54	61	3	4	1	1	15.9	0.37	1.6	0.88	0.336		
	22.25	21	17	1	1	49 500	60 000	5 600	7 500		—	41	39	59	51	62	3	5	1	1	20.2	0.59	1.0	0.56	0.335		
	26	26	20.5	1	1	70 000	86 500	5 600	8 000		2DE	41	38	59	55	62	5	5.5	1	1	17.0	0.35	1.7	0.95	0.40		
	21.75	20	17	1.5	1.5	56 000	56 000	5 300	7 100		—	44	42	66	64	68	3	4.5	1.5	1.5	15.9	0.33	1.8	1.0	0.435		
	35	14	14	11.5	0.6	0.6	27 400	39 000	6 300		8 500	HR 32907 J HR 32007 XJ HR 33007 J	2BD	43	40	50	50	52.5	3	2.5	0.6	0.6	10.7	0.29	2.1	1.1	0.123
18		18	14	1	1	43 500	55 500	5 600	8 000	4CC	44		40	56	54	60	4	4	1	1	15.0	0.45	1.3	0.73	0.229		
21		21	17	1	1	49 000	65 000	5 600	8 000	2CE	44		40	56	55	59	4	4	1	1	14.1	0.31	2.0	1.1	0.267		
72		18.25	17	15	1.5	1.5	54 000	59 500	5 300	7 100	HR 30207 J HR 30207 C HR 32207 J	3DB	46	43	63	62	67	3	3	1.5	1.5	15.0	0.37	1.6	0.88	0.34	
		18.25	17	13	1.5	1.5	47 000	54 500	5 000	6 700		—	46	44	63	59	68	3	5	1.5	1.5	19.6	0.66	0.91	0.50	0.331	
		24.25	23	19	1.5	1.5	70 500	83 500	5 300	7 100		3DC	46	42	63	61	67.5	3	5	1.5	1.5	17.9	0.37	1.6	0.88	0.456	
72		24.25	23	18	1.5	1.5	60 500	71 500	5 000	7 100	HR 32207 C HR 33207 J HR 30307 J	—	46	42	63	58	68.5	3	6	1.5	1.5	20.6	0.55	1.1	0.60	0.442	
		28	28	22	1.5	1.5	86 500	108 000	5 300	7 100		2DE	46	41	63	61	68	5	6	1.5	1.5	18.3	0.35	1.7	0.93	0.54	
		22.75	21	18	2	1.5	76 000	79 000	4 800	6 700		2FB	47	45	71	69	74	3	4.5	2	1.5	16.7	0.32	1.9	1.1	0.538	
		80	22.75	21	16	2	1.5	68 000	70 500	4 800		6 300	HR 30307 C HR 30307 DJ HR 31307 J HR 32307 J	—	47	44	71	65	74	3	6.5	2	1.5	20.3	0.55	1.1	0.60
22.75			21	15	2	1.5	62 000	68 000	4 300	6 000	7FB	51		44	71	62	77	3	7.5	2	1.5	25.2	0.83	0.73	0.40	0.519	
22.75			21	15	2	1.5	62 000	68 000	4 300	6 000	7FB	51		44	71	62	77	3	7.5	2	1.5	25.2	0.83	0.73	0.40	0.52	
32.75	31		25	2	1.5	99 000	111 000	5 000	6 700	2FE	49	43		71	66	74	3	7.5	2	1.5	20.7	0.32	1.9	1.1	0.765		

Remark Suffix C represents medium-angle tapered roller bearings. Since they are designed for specific applications, please consult NSK when using bearings with suffix C.

■ SINGLE-ROW TAPERED ROLLER BEARINGS

Bore Diameter 40 – 50 mm

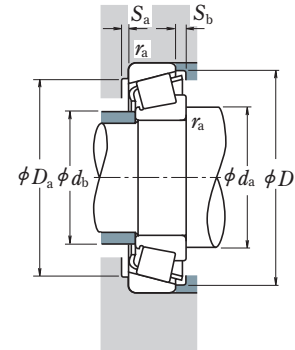
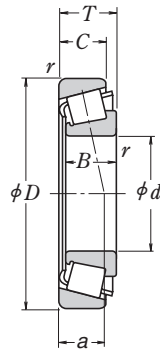

Dynamic Equivalent Load

$$P = XF_r + YF_a$$

$F_a/F_r \leq e$		$F_a/F_r > e$	
X	Y	X	Y
1	0	0.4	Y_1

Static Equivalent Load

$$P_0 = 0.5F_r + Y_0F_a$$

When $F_r > 0.5F_r + Y_0F_a$, use $P_0 = F_r$

The values of e , Y_1 , and Y_0 are given in the table below.

d	Boundary Dimensions (mm)				Ring: Inner Outer	Basic Load Ratings (N)	Limiting Speeds (min ⁻¹)		ISO355 Dimension Series approx.	Abutment and Fillet Dimensions (mm)						Eff. Load Center (mm) a	Constant e	Axial Load Factors		Mass (kg) approx.				
	D	T	B	C			C _r	C _{0r}		Grease	Oil	d _a min.	d _b max.	D _a max.	D _b min.			S _a min.	S _b min.		r _a min.	r _a max.	Y ₁	Y ₀
40	62	15	15	12	0.6	0.6	34 000	47 000	2BC	48	44	57	57	59	3	3	0.6	0.6	11.5	0.29	2.1	1.1	0.161	
	68	19	19	14.5	1	1	53 000	71 000	3CD	49	45	62	60	65.5	4	4.5	1	1	15.0	0.38	1.6	0.87	0.28	
	68	22	22	18	1	1	59 000	81 500	2BE	49	45	62	61	65	4	4	1	1	14.6	0.28	2.1	1.2	0.322	
	75	26	26	20.5	1.5	1.5	78 500	101 000	2CE	51	46	66	65	71	4	5.5	1.5	1.5	18.0	0.36	1.7	0.93	0.503	
	80	19.75	18	16	1.5	1.5	63 500	70 000	3DB	51	48	71	69	75	3	3.5	1.5	1.5	16.6	0.37	1.6	0.88	0.437	
	80	24.75	23	19	1.5	1.5	77 000	90 500	3DC	51	48	71	68	75	3	5.5	1.5	1.5	18.9	0.37	1.6	0.88	0.548	
	80	24.75	23	19	1.5	1.5	74 000	90 500	5DC	51	47	71	65	76	3	5.5	1.5	1.5	21.9	0.55	1.1	0.60	0.558	
	80	32	32	25	1.5	1.5	107 000	137 000	2DE	51	46	71	67	76	5	7	1.5	1.5	20.8	0.36	1.7	0.92	0.744	
	90	25.25	23	20	2	1.5	90 500	101 000	2FB	52	52	81	76	82	3	5	2	1.5	19.5	0.35	1.7	0.96	0.758	
	90	25.25	23	18	2	1.5	84 500	93 500	—	52	50	81	72	84	3	7	2	1.5	22.8	0.53	1.1	0.62	0.735	
	90	25.25	23	17	2	1.5	80 000	89 500	7FB	56	50	81	70	87	3	8	2	1.5	28.7	0.83	0.73	0.40	0.728	
	90	25.25	23	17	2	1.5	80 000	89 500	7FB	56	50	81	70	87	3	8	2	1.5	28.7	0.83	0.73	0.40	0.728	
	90	35.25	33	27	2	1.5	120 000	145 000	2FD	54	50	81	73	82	3	8	2	1.5	23.4	0.35	1.7	0.96	1.05	
	45	68	15	15	12	0.6	0.6	34 500	50 500	2BC	53	50	63	62	64	3	3	0.6	0.6	12.3	0.32	1.9	1.0	0.187
		75	20	20	15.5	1	1	60 000	83 000	3CC	54	51	69	67	72	4	4.5	1	1	16.6	0.39	1.5	0.84	0.354
		75	24	24	19	1	1	69 000	99 000	2CE	54	51	69	67	71	4	5	1	1	16.3	0.29	2.0	1.1	0.414
80		26	26	20.5	1.5	1.5	84 000	113 000	3CE	56	51	71	69	77	4	5.5	1.5	1.5	19.1	0.38	1.6	0.86	0.552	
85		20.75	19	16	1.5	1.5	68 500	79 500	3DB	56	53	76	74	80	3	4.5	1.5	1.5	18.3	0.41	1.5	0.81	0.488	
85		24.75	23	19	1.5	1.5	83 000	102 000	3DC	56	53	76	73	81	3	5.5	1.5	1.5	20.1	0.41	1.5	0.81	0.602	
85		24.75	23	19	1.5	1.5	75 500	95 500	5DC	56	52	76	70	82	3	5.5	1.5	1.5	23.6	0.59	1.0	0.56	0.603	
85		32	32	25	1.5	1.5	111 000	147 000	3DE	56	51	76	72	81	5	7	1.5	1.5	22.0	0.39	1.6	0.86	0.817	
95		29	26.5	20	2.5	2.5	88 500	109 000	7FC	60	53	83	71	91	3	9	2	2	32.1	0.87	0.69	0.38	0.918	
95		36	35	30	2.5	2.5	139 000	174 000	2ED	60	54	83	79	89	5	6	2	2	23.5	0.32	1.9	1.02	1.22	
100		27.25	25	22	2	1.5	112 000	127 000	2FB	57	58	91	86	93	3	5	2	1.5	21.1	0.35	1.7	0.96	1.01	
100		27.25	25	18	2	1.5	95 500	109 000	7FB	61	57	91	79	96	3	9	2	1.5	31.5	0.83	0.73	0.40	0.957	
100		27.25	25	18	2	1.5	95 500	109 000	2FD	59	56	91	82	93	3	8	2	1.5	25.0	0.35	1.7	0.96	1.42	
100		38.25	36	30	2	1.5	144 000	177 000	3CC	59	56	74	71	77	4	4.5	1	1	17.9	0.42	1.4	0.78	0.38	
50		100	36	35	30	2.5	2.5	144 000	185 000	2ED	65	59	88	83	94	6	6	2	2	24.2	0.34	1.8	0.96	1.3
		72	15	15	12	0.6	0.6	36 000	54 000	2BC	58	54	67	66	69	3	3	0.6	0.6	13.5	0.34	1.8	0.97	0.193
	80	20	20	15.5	1	1	61 000	87 000	3CC	59	56	74	71	77	4	4.5	1	1	17.9	0.42	1.4	0.78	0.38	
	80	24	24	19	1	1	70 500	104 000	2CE	59	55	74	71	76	4	5	1	1	17.4	0.32	1.9	1.0	0.452	
	85	26	26	20	1.5	1.5	89 000	126 000	3CE	61	56	76	74	82	4	6	1.5	1.5	20.3	0.41	1.5	0.8	0.597	
	90	21.75	20	17	1.5	1.5	76 000	91 500	3DB	61	58	81	79	85	3	4.5	1.5	1.5	19.6	0.42	1.4	0.79	0.557	
	90	24.75	23	19	1.5	1.5	87 500	109 000	3DC	61	57	81	78	86	3	5.5	1.5	1.5	21.0	0.42	1.4	0.79	0.642	
	90	24.75	23	18	1.5	1.5	77 500	102 000	5DC	61	58	81	76	87	3	6.5	1.5	1.5	24.6	0.59	1.0	0.56	0.655	
	90	32	32	24.5	1.5	1.5	118 000	165 000	3DE	61	56	81	76	87	5	7.5	1.5	1.5	23.2	0.41	1.5	0.80	0.867	
	105	32	29	22	3	3	109 000	133 000	7FC	74	59	91	78	100	5	10	2.5	2.5	36.4	0.87	0.69	0.38	1.22	
	110	29.25	27	23	2.5	2	130 000	148 000	2FB	65	65	100	95	102	3	6	2	2	23.1	0.35	1.7	0.96	1.28	
	110	29.25	27	19	2.5	2	114 000	132 000	7FB	70	62	100	87	105	3	10	2	2	34.3	0.83	0.73	0.40	1.26	
	110	29.25	27	19	2.5	2	114 000	132 000	7FB	70	62	100	87	105	3	10	2	2	34.3	0.83	0.73	0.40	1.26	
	110	42.25	40	33	2.5	2	176 000	220 000	2FD	68	62	100	91	102	3	9	2	2	28.0	0.35	1.7	0.96	1.88	
	110	42.25	40	33	2.5	2	164 000	218 000	5FD	68	59	100	82	103	3	9	2	2	32.8	0.55	1.1	0.60	1.93	

Remark Suffix C represents medium-angle tapered roller bearings. Since they are designed for specific applications, please consult NSK when using bearings with suffix C.

SINGLE-ROW TAPERED ROLLER BEARINGS

Bore Diameter 55 – 65 mm

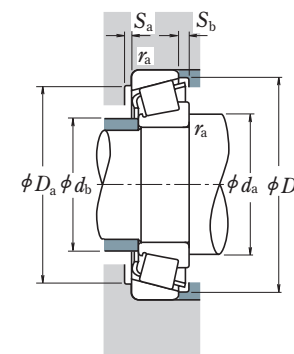
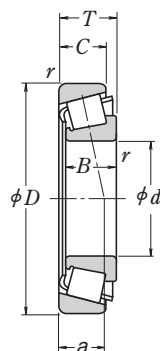

Dynamic Equivalent Load

$$P = XF_r + YF_a$$

$F_a/F_r \leq e$		$F_a/F_r > e$	
X	Y	X	Y
1	0	0.4	Y_1

Static Equivalent Load

$$P_0 = 0.5F_r + Y_0F_a$$

When $F_r > 0.5F_r + Y_0F_a$, use $P_0 = F_r$

The values of e , Y_1 , and Y_0 are given in the table below.

d	D	Boundary Dimensions (mm)				Ring:		Basic Load Ratings (N)		Limiting Speeds (min ⁻¹)		ISO355 Dimension Series approx.	Abutment and Fillet Dimensions (mm)						Eff. Load Center (mm) a	Constant e	Axial Load Factors		Mass (kg) approx.			
		T	B	C	r	Inner	Outer	C _r	C _{0r}	Grease	Oil		d _a min.	d _b max.	D _a max.	D _b min.	S _a min.	S _b min.			r _a min.	r _a max.		Y ₁	Y ₀	
55	80	17	17	14	1	1	45 500	74 500	4 300	5 600	HR 32911 J	2BC	64	60	74	73	76	4	3	1	1	14.6	0.31	1.9	1.1	0.282
	90	23	23	17.5	1.5	1.5	81 500	117 000	3 800	5 300	HR 32011 XJ	3CC	66	62	81	80	86	4	5.5	1.5	1.5	19.7	0.41	1.5	0.81	0.568
	90	27	27	21	1.5	1.5	91 500	138 000	3 800	5 300	HR 33011 J	2CE	66	62	81	80	86	5	6	1.5	1.5	19.2	0.31	1.9	1.1	0.657
	95	30	30	23	1.5	1.5	112 000	158 000	3 800	5 000	HR 33111 J	3CE	66	62	86	82	91	5	7	1.5	1.5	22.4	0.37	1.6	0.88	0.877
	100	22.75	21	18	2	1.5	94 500	113 000	3 600	5 000	HR 30211 J	3DB	67	64	91	89	94	4	4.5	2	1.5	20.9	0.41	1.5	0.81	0.736
	100	26.75	25	21	2	1.5	110 000	137 000	3 600	5 000	HR 32211 J	3DC	67	63	91	87	95	4	5.5	2	1.5	22.7	0.41	1.5	0.81	0.859
	100	35	35	27	2	1.5	141 000	193 000	3 600	5 000	HR 33211 J	3DE	67	62	91	86	96	6	8	2	1.5	25.2	0.40	1.5	0.83	1.18
	115	34	31	23.5	3	3	126 000	164 000	3 000	4 300	T 7 FC055	7FC	73	66	101	86	109	4	10.5	2.5	2.5	39.0	0.87	0.69	0.38	1.58
	120	31.5	29	25	2.5	2	150 000	171 000	3 200	4 300	HR 30311 J	2FB	70	71	110	104	111	4	6.5	2	2	24.6	0.35	1.7	0.96	1.63
	120	31.5	29	21	2.5	2	131 000	153 000	2 800	4 000	HR 30311 DJ	7FB	75	67	110	94	114	4	10.5	2	2	37.0	0.83	0.73	0.40	1.58
	120	31.5	29	21	2.5	2	131 000	153 000	2 800	4 000	HR 31311 J	7FB	75	67	110	94	114	4	10.5	2	2	37.0	0.83	0.73	0.40	1.58
	120	45.5	43	35	2.5	2	204 000	258 000	3 200	4 300	HR 32311 J	2FD	73	67	110	99	111	4	10.5	2	2	29.9	0.35	1.7	0.96	2.39
	120	45.5	43	35	2.5	2	195 000	262 000	3 200	4 300	HR 32311 CJ	5FD	73	65	110	91	112	4	10.5	2	2	35.8	0.55	1.1	0.60	2.47
60	85	17	17	14	1	1	49 000	84 500	3 800	5 300	HR 32912 J	2BC	69	65	79	78	81	4	3	1	1	15.5	0.33	1.8	1.0	0.306
	95	23	23	17.5	1.5	1.5	85 500	127 000	3 600	5 000	HR 32012 XJ	4CC	71	66	86	85	91	4	5.5	1.5	1.5	20.9	0.43	1.4	0.77	0.608
	95	27	27	21	1.5	1.5	96 000	150 000	3 600	5 000	HR 33012 J	2CE	71	66	86	85	90	5	6	1.5	1.5	20.0	0.33	1.8	1.0	0.713
	100	30	30	23	1.5	1.5	115 000	166 000	3 400	4 800	HR 33112 J	3CE	71	68	91	88	96	5	7	1.5	1.5	23.6	0.40	1.5	0.83	0.91
	110	23.75	22	19	2	1.5	104 000	123 000	3 400	4 500	HR 30212 J	3EB	72	69	101	96	103	4	4.5	2	1.5	22.0	0.41	1.5	0.81	0.930
	110	29.75	28	24	2	1.5	131 000	167 000	3 400	4 500	HR 32212 J	3EC	72	68	101	95	104	4	5.5	2	1.5	24.1	0.41	1.5	0.81	1.18
	110	38	38	29	2	1.5	166 000	231 000	3 400	4 500	HR 33212 J	3EE	72	68	101	94	105	6	9	2	1.5	27.6	0.40	1.5	0.82	1.56
	125	37	33.5	26	3	3	151 000	197 000	2 800	3 800	T 7 FC060	7FC	78	72	111	94	119	4	11	2.5	2.5	41.4	0.82	0.73	0.40	2.03
	130	33.5	31	26	3	2.5	174 000	201 000	3 000	4 000	HR 30312 J	2FB	78	77	118	112	120	4	7.5	2.5	2	26.0	0.35	1.7	0.96	2.03
	130	33.5	31	22	3	2.5	151 000	177 000	2 600	3 800	HR 30312 DJ	7FB	84	74	118	103	125	4	11.5	2.5	2	40.3	0.83	0.73	0.40	1.98
	130	33.5	31	22	3	2.5	151 000	177 000	2 600	3 800	HR 31312 J	7FB	84	74	118	103	125	4	11.5	2.5	2	40.3	0.83	0.73	0.40	1.98
	130	48.5	46	37	3	2.5	233 000	295 000	3 000	4 000	HR 32312 J	2FD	81	74	118	107	120	4	11.5	2.5	2	31.4	0.35	1.7	0.96	2.96
	130	48.5	46	35	3	2.5	196 000	249 000	2 800	3 800	32312 C	—	81	74	116	102	125	4	13.5	2.5	2	39.9	0.58	1.0	0.57	2.86
65	90	17	17	14	1	1	49 000	86 500	3 600	5 000	HR 32913 J	2BC	74	70	84	82	86	4	3	1	1	16.8	0.35	1.7	0.93	0.323
	100	23	23	17.5	1.5	1.5	86 500	132 000	3 400	4 500	HR 32013 XJ	4CC	76	71	91	90	97	4	5.5	1.5	1.5	22.4	0.46	1.3	0.72	0.646
	100	27	27	21	1.5	1.5	97 500	156 000	3 400	4 500	HR 33013 J	2CE	76	71	91	90	96	5	6	1.5	1.5	21.1	0.35	1.7	0.95	0.76
	110	34	34	26.5	1.5	1.5	148 000	218 000	3 200	4 300	HR 33113 J	3DE	76	73	101	96	106	6	7.5	1.5	1.5	26.0	0.39	1.5	0.85	1.32
	120	24.75	23	20	2	1.5	122 000	151 000	3 000	4 000	HR 30213 J	3EB	77	78	111	106	113	4	4.5	2	1.5	23.8	0.41	1.5	0.81	1.18
	120	32.75	31	27	2	1.5	157 000	202 000	3 000	4 000	HR 32213 J	3EC	77	75	111	104	115	4	5.5	2	1.5	27.1	0.41	1.5	0.81	1.55
	120	41	41	32	2	1.5	202 000	282 000	3 000	4 000	HR 33213 J	3EE	77	74	111	102	115	6	9	2	1.5	29.2	0.39	1.5	0.85	2.04
	140	36	33	28	3	2.5	200 000	233 000	2 600	3 600	HR 30313 J	2GB	83	83	128	121	130	4	8	2.5	2	27.9	0.35	1.7	0.96	2.51
	140	36	33	23	3	2.5	173 000	205 000	2 400	3 400	HR 30313 DJ	7GB	89	80	128	111	133	4	13	2.5	2	43.2	0.83	0.73	0.40	2.43
	140	36	33	23	3	2.5	173 000	205 000	2 400	3 400	HR 31313 J	7GB	89	80	128	111	133	4	13	2.5	2	43.2	0.83	0.73	0.40	2.43
	140	51	48	39	3	2.5	267 000	340 000	2 800	3 800	HR 32313 J	2GD	86	80	128	116	130	4	12	2.5	2	34.0	0.35	1.7	0.96	3.6

Remark Suffix C represents medium-angle tapered roller bearings. Since they are designed for specific applications, please consult NSK when using bearings with suffix C.

SINGLE-ROW TAPERED ROLLER BEARINGS

Bore Diameter 70 – 80 mm

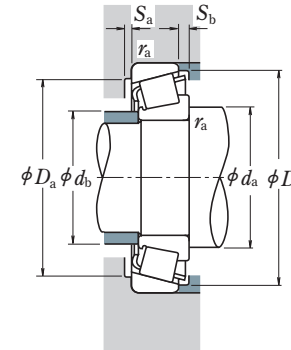
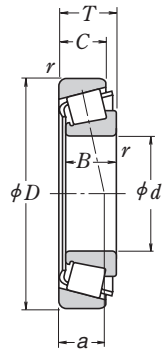

Dynamic Equivalent Load
 $P = X F_r + Y F_a$

$F_a / F_r \leq e$		$F_a / F_r > e$	
X	Y	X	Y
1	0	0.4	Y_1

Static Equivalent Load

$P_0 = 0.5 F_r + Y_0 F_a$
 When $F_r > 0.5 F_r + Y_0 F_a$, use $P_0 = F_r$
 The values of e , Y_1 , and Y_0 are given in the table below.

d	Boundary Dimensions (mm)					Ring:		Basic Load Ratings (N)		Limiting Speeds (min ⁻¹)		Bearing Designation	ISO355 Dimension Series approx.	Abutment and Fillet Dimensions (mm)						Eff. Load Center (mm) a	Constant e	Axial Load Factors		Mass (kg) approx.		
	D	T	B	C	r	Inner	Outer	C _r	C _{0r}	Grease	Oil			d _a min.	d _b max.	D _a max.	D _b min.	S _a min.	S _b min.			Inner	Outer		Y ₁	Y ₀
70	100	20	20	16	1	1	70 000	113 000	3 200	4 500	HR 32914 J	2BC	79	76	94	93	96	4	4	1	1	17.6	0.32	1.9	1.1	0.494
	110	25	25	19	1.5	1.5	104 000	158 000	3 200	4 300	HR 32014 XJ	4CC	81	77	101	98	105	5	6	1.5	1.5	23.7	0.43	1.4	0.76	0.869
	110	31	31	25.5	1.5	1.5	127 000	204 000	3 000	4 300	HR 33014 J	2CE	81	78	101	100	105	5	5.5	1.5	1.5	22.2	0.28	2.1	1.2	1.11
	120	37	37	29	2	1.5	177 000	262 000	3 000	4 000	HR 33114 J	3DE	82	79	111	104	115	6	8	2	1.5	27.9	0.38	1.6	0.87	1.71
	125	26.25	24	21	2	1.5	132 000	163 000	2 800	4 000	HR 30214 J	3EB	82	81	116	110	118	4	5	2	1.5	25.6	0.42	1.4	0.79	1.3
	125	33.25	31	27	2	1.5	157 000	205 000	2 800	4 000	HR 32214 J	3EC	82	80	116	108	119	4	6	2	1.5	28.6	0.42	1.4	0.79	1.66
	125	41	41	32	2	1.5	209 000	299 000	2 800	4 000	HR 33214 J	3EE	82	78	116	107	120	7	9	2	1.5	30.4	0.41	1.5	0.81	2.15
	140	39	35.5	27	3	3	178 000	235 000	2 400	3 400	T 7 FC070	7FC	88	81	126	106	133	5	12	2.5	2.5	46.4	0.87	0.69	0.38	2.58
	150	38	35	30	3	2.5	227 000	268 000	2 400	3 400	HR 30314 J	2GB	88	89	138	132	140	4	8	2.5	2	29.7	0.35	1.7	0.96	3.03
	150	38	35	25	3	2.5	192 000	229 000	2 200	3 200	HR 30314 DJ	7GB	94	85	138	118	142	4	13	2.5	2	45.8	0.83	0.73	0.40	2.94
	150	38	35	25	3	2.5	192 000	229 000	2 200	3 200	HR 31314 J	7GB	94	85	138	118	142	4	13	2.5	2	45.8	0.83	0.73	0.40	2.94
	150	54	51	42	3	2.5	300 000	390 000	2 600	3 400	HR 32314 J	2GD	91	86	138	124	140	4	12	2.5	2	36.1	0.35	1.7	0.96	4.35
	150	54	51	42	3	2.5	280 000	390 000	2 400	3 400	HR 32314 CJ	5GD	91	84	138	115	141	4	12	2.5	2	43.3	0.55	1.1	0.60	4.47
75	105	20	20	16	1	1	72 500	120 000	3 200	4 300	HR 32915 J	2BC	84	81	99	98	101	4	4	1	1	18.7	0.33	1.8	0.99	0.53
	115	25	25	19	1.5	1.5	109 000	171 000	3 000	4 000	HR 32015 XJ	4CC	86	82	106	103	110	5	6	1.5	1.5	25.1	0.46	1.3	0.72	0.925
	115	31	31	25.5	1.5	1.5	133 000	220 000	3 000	4 000	HR 33015 J	2CE	86	83	106	104	110	6	5.5	1.5	1.5	23.0	0.30	2.0	1.1	1.18
	125	37	37	29	2	2	182 000	275 000	2 800	3 800	HR 33115 J	3DE	87	83	115	109	120	6	8	2	2	29.2	0.40	1.5	0.83	1.8
	130	27.25	25	22	2	1.5	143 000	182 000	2 800	3 800	HR 30215 J	4DB	87	85	121	115	124	4	5	2	1.5	27.0	0.44	1.4	0.76	1.43
	130	33.25	31	27	2	1.5	165 000	219 000	2 800	3 800	HR 32215 J	4DC	87	84	121	113	125	4	6	2	1.5	29.8	0.44	1.4	0.76	1.72
	130	41	41	31	2	1.5	215 000	315 000	2 800	3 800	HR 33215 J	3EE	87	83	121	111	125	7	10	2	1.5	31.6	0.43	1.4	0.77	2.25
	160	40	37	31	3	2.5	253 000	300 000	2 400	3 200	HR 30315 J	2GB	93	95	148	141	149	4	9	2.5	2	31.8	0.35	1.7	0.96	3.63
	160	40	37	26	3	2.5	211 000	251 000	2 200	3 000	HR 30315 DJ	7GB	99	91	148	129	152	6	14	2.5	2	48.8	0.83	0.73	0.40	3.47
	160	40	37	26	3	2.5	211 000	251 000	2 200	3 000	HR 31315 J	7GB	99	91	148	129	152	6	14	2.5	2	48.8	0.83	0.73	0.40	3.47
	160	58	55	45	3	2.5	340 000	445 000	2 400	3 200	HR 32315 J	2GD	96	91	148	134	149	4	13	2.5	2	38.9	0.35	1.7	0.96	5.31
	160	58	55	43	3	2.5	310 000	420 000	2 200	3 200	32315 CA	—	96	90	148	124	153	4	15	2.5	2	47.7	0.58	1.0	0.57	5.3
	80	110	20	20	16	1	1	75 000	128 000	3 000	4 000	HR 32916 J	2BC	89	85	104	102	106	4	4	1	1	19.8	0.35	1.7	0.94
125		29	29	22	1.5	1.5	140 000	222 000	2 800	3 600	HR 32016 XJ	3CC	91	89	116	112	120	6	7	1.5	1.5	26.9	0.42	1.4	0.78	1.32
125		36	36	29.5	1.5	1.5	172 000	282 000	2 800	3 600	HR 33016 J	2CE	91	88	116	112	119	6	6.5	1.5	1.5	25.5	0.28	2.2	1.2	1.66
130		37	37	29	2	1.5	186 000	289 000	2 600	3 600	HR 33116 J	3DE	92	88	121	113	126	6	8	2	1.5	30.4	0.42	1.4	0.79	1.88
140		28.25	26	22	2.5	2	157 000	195 000	2 600	3 400	HR 30216 J	3EB	95	91	130	124	132	4	6	2	2	28.1	0.42	1.4	0.79	1.68
140		28.25	26	20	2.5	2	147 000	190 000	2 400	3 400	30216 CA	—	95	92	130	122	133	4	8	2	2	33.8	0.58	1.0	0.57	1.66
140		35.25	33	28	2.5	2	192 000	254 000	2 600	3 400	HR 32216 J	3EC	95	90	130	122	134	4	7	2	2	30.6	0.42	1.4	0.79	2.13
140		46	46	35	2.5	2	256 000	385 000	2 600	3 400	HR 33216 J	3EE	95	89	130	119	135	7	11	2	2	34.8	0.43	1.4	0.78	2.93
170		42.5	39	33	3	2.5	276 000	330 000	2 200	3 000	HR 30316 J	2GB	98	102	158	150	159	4	9.5	2.5	2	34.0	0.35	1.7	0.96	4.27
170		42.5	39	27	3	2.5	235 000	283 000	2 000	2 800	HR 30316 DJ	7GB	104	97	158	136	159	6	15.5	2.5	2	51.8	0.83	0.73	0.40	4.07
170		42.5	39	27	3	2.5	235 000	283 000	2 000	2 800	HR 31316 J	7GB	104	97	158	136	159	6	15.5	2.5	2	51.8	0.83	0.73	0.40	4.07
170		61.5	58	48	3	2.5	385 000	505 000	2 200	3 000	HR 32316 J	2GD	101	98	158	143	159	4	13.5	2.5	2	41.4	0.35	1.7	0.96	6.35
170		61.5	58	48	3	2.5	365 000	530 000	2 200	3 000	HR 32316 CJ	5GD	101	95	158	132	160	4	13.5	2.5	2	49.3	0.55	1.1	0.60	6.59

Remark Suffix CA represents medium-angle tapered roller bearings. Since they are designed for specific applications, please consult NSK when using bearings with suffix CA.

SINGLE-ROW TAPERED ROLLER BEARINGS

Bore Diameter 105 – 130 mm

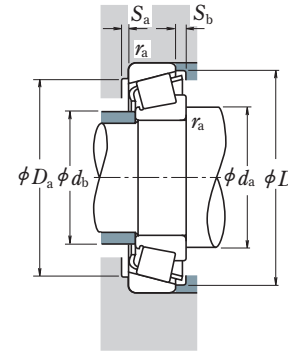
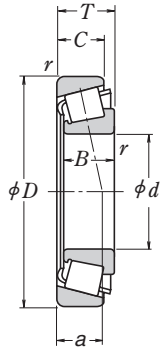

Dynamic Equivalent Load

$$P = XF_r + YF_a$$

$F_a / F_r \leq e$		$F_a / F_r > e$	
X	Y	X	Y
1	0	0.4	Y_1

Static Equivalent Load

$$P_0 = 0.5F_r + Y_0F_a$$

When $F_r > 0.5F_r + Y_0F_a$, use $P_0 = F_r$

The values of e , Y_1 , and Y_0 are given in the table below.

d	Boundary Dimensions (mm)				Ring:		Basic Load Ratings (N)		Limiting Speeds (min ⁻¹)		Bearing Designation	ISO355 Dimension Series approx.	Abutment and Fillet Dimensions (mm)						Ring: Inner Outer r_a max.	Eff. Load Center (mm) a	Constant e	Axial Load Factors		Mass (kg) approx.		
	D	T	B	C	Inner	Outer	C_r	C_{Or}	Grease	Oil			d_a min.	d_b max.	D_a max.	D_b min.	S_a min.	S_b min.				Y_1	Y_0			
105	145	25	25	20	1.5	1.5	119 000	212 000	2 200	3 000	HR 32921 J HR 32021 XJ HR 33021 J HR 30221 J HR 32221 J HR 30321 J HR 31321 J HR 32321 J	2CC 4DC 2DE	116	114	137	137	140	5	5	1.5	1.5	25.3	0.34	1.8	0.96	1.23
	160	35	35	26	2.5	2	204 000	340 000	2 000	2 800			120	115	150	144	154	6	9	2	2	34.3	0.44	1.4	0.74	2.48
	160	43	43	34	2.5	2	256 000	435 000	2 000	2 800			120	115	150	146	153	7	9	2	2	30.9	0.28	2.1	1.2	3.03
	190	39	36	30	3	2.5	280 000	365 000	1 900	2 600			123	123	178	166	177	6	9	2.5	2	38.1	0.42	1.4	0.79	4.51
	190	53	50	43	3	2.5	360 000	510 000	1 900	2 600			123	120	178	162	180	5	10	2.5	2	44.8	0.42	1.4	0.79	6.25
	225	53.5	49	41	4	3	455 000	565 000	1 600	2 200			126	133	211	195	206	6	12.5	3	2.5	43.3	0.35	1.7	0.96	9.52
	225	58	53	36	4	3	415 000	540 000	1 500	2 000			141	130	211	177	211	7	22	3	2.5	70.2	0.83	0.73	0.40	10
225	81.5	77	63	4	3	670 000	925 000	1 700	2 200	130	129	211	186	209	6	18.5	3	2.5	55.2	0.35	1.7	0.96	14.9			
110	150	25	25	20	1.5	1.5	123 000	224 000	2 200	2 800	HR 32922 J HR 32022 XJ HR 33022 J HR 30322 J HR 31322 J HR 32222 J HR 30322 J HR 31322 J HR 32322 J	2CC 4DC 2DE	121	119	142	142	145	5	5	1.5	1.5	26.5	0.36	1.7	0.93	1.29
	170	38	38	29	2.5	2	236 000	390 000	2 000	2 600			125	121	160	153	163	7	9	2	2	35.9	0.43	1.4	0.77	3.09
	170	47	47	37	2.5	2	294 000	515 000	2 000	2 600			125	121	160	153	161	7	10	2	2	33.7	0.29	2.1	1.2	3.84
	180	56	56	43	2.5	2	365 000	610 000	1 900	2 600			125	121	170	156	174	9	13	2	2	44.1	0.42	1.4	0.79	5.54
	200	41	38	32	3	2.5	315 000	420 000	1 800	2 400			128	129	188	175	187	6	9	2.5	2	40.2	0.42	1.4	0.79	5.28
	200	56	53	46	3	2.5	400 000	565 000	1 800	2 400			128	127	188	171	190	5	10	2.5	2	47.2	0.42	1.4	0.79	7.35
	240	54.5	50	42	4	3	485 000	595 000	1 500	2 000			131	143	226	208	220	6	12.5	3	2.5	45.1	0.35	1.7	0.96	11
240	63	57	38	4	3	470 000	605 000	1 400	1 900	146	136	226	191	224	7	25	3	2.5	74.8	0.83	0.73	0.40	12.3			
240	84.5	80	65	4	3	675 000	910 000	1 500	2 000	135	139	226	201	222	6	19.5	3	2.5	58.6	0.35	1.7	0.96	17.1			
120	165	29	29	23	1.5	1.5	161 000	291 000	1 900	2 600	HR 32924 J T 4 CB120 HR 32024 XJ HR 33024 J HR 31324 J HR 30224 J HR 32224 J HR 30324 J HR 31324 J HR 32324 J	2CC 4CB 4DC	131	129	156	155	160	6	6	1.5	1.5	29.2	0.35	1.7	0.95	1.8
	170	27	25	19.5	3	3	153 000	243 000	1 800	2 600			138	129	158	158	164	7	7.5	2.5	2.5	35.0	0.47	1.3	0.70	1.78
	180	38	38	29	2.5	2	242 000	405 000	1 800	2 400			135	131	170	162	173	7	9	2	2	39.7	0.46	1.3	0.72	3.27
	180	48	48	38	2.5	2	300 000	540 000	1 800	2 600			135	130	168	161	171	6	10	2	2	36.0	0.31	2.0	1.1	4.2
	200	62	62	48	2.5	2	460 000	755 000	1 700	2 400			135	133	190	173	192	9	14	2	2	47.9	0.40	1.5	0.83	7.67
	215	43.5	40	34	3	2.5	335 000	450 000	1 600	2 200			138	141	203	190	201	6	9.5	2.5	2	44.4	0.44	1.4	0.76	6.28
	215	61.5	58	50	3	2.5	440 000	635 000	1 600	2 200			138	137	203	181	204	6	11.5	2.5	2	52.1	0.44	1.4	0.76	9.0
260	59.5	55	46	4	3	535 000	655 000	1 400	1 900	141	154	246	223	237	6	13.5	3	2.5	50.0	0.35	1.7	0.96	13.9			
260	68	62	42	4	3	560 000	730 000	1 300	1 800	156	148	246	206	244	9	26	3	2.5	81.7	0.83	0.73	0.40	15.6			
260	90.5	86	69	4	3	770 000	1 060 000	1 400	1 900	145	149	246	216	239	6	21.5	3	2.5	62.5	0.35	1.7	0.96	21.8			
130	180	32	30	26	2	1.5	167 000	281 000	1 800	2 400	32926 HR 32926 J T 4 CB130 HR 32026 XJ HR 33026 J HR 30226 J HR 32226 J 30326 HR 30326 J HR 31326 J 32326	— 2CC 4CB	142	141	171	168	175	6	6	2	1.5	34.7	0.36	1.7	0.92	2.25
	180	32	32	25	2	1.5	200 000	365 000	1 800	2 400			142	140	170	168	173	6	7	2	1.5	31.4	0.34	1.8	0.97	2.46
	185	29	27	21	3	3	183 000	296 000	1 700	2 400			148	141	171	171	179	8	8	2.5	2.5	37.5	0.47	1.3	0.70	2.32
	200	45	45	34	2.5	2	320 000	535 000	1 600	2 200			145	144	190	179	192	8	11	2	2	43.9	0.43	1.4	0.76	5.06
	200	55	55	43	2.5	2	395 000	715 000	1 700	2 200			145	144	188	179	192	8	12	2	2	42.4	0.34	1.8	0.97	6.25
	230	43.75	40	34	4	3	375 000	505 000	1 500	2 000			151	151	216	205	217	7	9.5	3	2.5	45.9	0.44	1.4	0.76	7.25
	230	67.75	64	54	4	3	530 000	790 000	1 500	2 000			151	147	216	196	219	7	13.5	3	2.5	57.0	0.44	1.4	0.76	11.3
	280	63.75	58	49	5	4	545 000	675 000	1 300	1 800			157	168	262	239	255	8	14.5	4	3	53.9	0.36	1.7	0.92	16.6
	280	63.75	58	49	5	4	650 000	820 000	1 300	1 800			157	166	262	241	255	8	14.5	4	3	52.8	0.35	1.7	0.96	17.2
	280	72	66	44	5	4	625 000	820 000	1 200	1 700			174	159	262	220	261	9	28	4	3	87.1	0.83	0.73	0.40	18.8
	280	98.75	93	78	5	4	830 000	1 150 000	1 300	1 800			162	165	262	233	263	8	20.5	4	3	69.2	0.36	1.7	0.92	26.6

SINGLE-ROW TAPERED ROLLER BEARINGS

Bore Diameter 140 – 170 mm

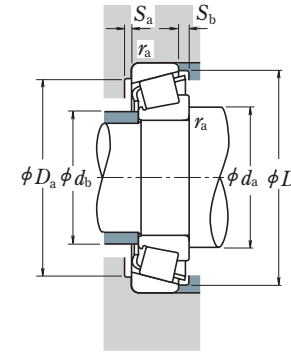
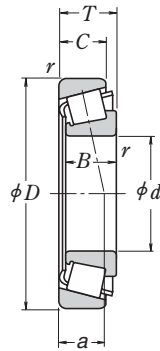

Dynamic Equivalent Load

$$P = XF_r + YF_a$$

$F_a/F_r \leq e$		$F_a/F_r > e$	
X	Y	X	Y
1	0	0.4	Y_1

Static Equivalent Load

$$P_0 = 0.5F_r + Y_0F_a$$

When $F_r > 0.5F_r + Y_0F_a$, use $P_0 = F_r$

The values of e , Y_1 , and Y_0 are given in the table below.

d	Boundary Dimensions (mm)				Ring:		Basic Load Ratings (N)		Limiting Speeds (min ⁻¹)		Bearing Designation	ISO355 Dimension Series approx.	Abutment and Fillet Dimensions (mm)						Ring: Inner Outer	Eff. Load Center (mm) a	Constant e	Axial Load Factors		Mass (kg) approx.		
	D	T	B	C	Inner	Outer	C _r	C _{0r}	Grease	Oil			d _a min.	d _b max.	D _a max.	D _b min.	S _a min.	S _b min.				r _a min.	r _a max.		Y ₁	Y ₀
140	190	32	32	25	2	1.5	206 000	390 000	1 700	2 200	HR 32928 J	2CC	152	150	180	178	184	6	7	2	1.5	33.6	0.36	1.7	0.92	2.64
	210	45	45	34	2.5	2	325 000	555 000	1 600	2 200	HR 32028 XJ	4DC	155	152	200	189	202	8	11	2	2	46.6	0.46	1.3	0.72	5.32
	210	56	56	44	2.5	2	410 000	770 000	1 600	2 200	HR 30328 J	2DE	155	153	198	189	202	7	12	2	2	45.5	0.36	1.7	0.92	6.74
	250	45.75	42	36	4	3	390 000	515 000	1 400	1 900	HR 30228 J	4FB	161	164	236	221	234	7	9.5	3	2.5	48.9	0.44	1.4	0.76	8.74
	250	71.75	68	58	4	3	610 000	915 000	1 400	1 900	HR 32228 J	4FD	161	159	236	213	238	9	13.5	3	2.5	60.5	0.44	1.4	0.76	14.3
	300	67.75	62	53	5	4	740 000	945 000	1 200	1 700	HR 30328 J	2GB	167	177	282	256	273	9	14.5	4	3	55.7	0.35	1.7	0.96	21.1
150	300	77	70	47	5	4	695 000	955 000	1 100	1 500	HR 31328 J	7GB	184	174	282	236	280	9	30	4	3	92.9	0.83	0.73	0.40	28.5
	300	107.75	102	85	5	4	985 000	1 440 000	1 200	1 600	32328	—	172	177	282	246	281	9	22.5	4	3	76.4	0.37	1.6	0.88	33.9
	210	38	36	31	2.5	2	247 000	440 000	1 500	2 000	32930	—	165	162	200	195	201	7	7	2	2	36.7	0.33	1.8	1.0	3.8
	210	38	38	30	2.5	2	281 000	520 000	1 500	2 000	HR 32930 J	2DC	165	163	198	196	202	7	8	2	2	36.5	0.33	1.8	1.0	4.05
	225	48	48	36	3	2.5	375 000	650 000	1 400	2 000	HR 32030 XJ	4EC	168	164	213	202	216	8	12	2.5	2	49.8	0.46	1.3	0.72	6.6
	225	59	59	46	3	2.5	435 000	805 000	1 400	2 000	HR 33030 J	2EE	168	165	213	203	217	8	13	2.5	2	48.7	0.36	1.7	0.90	8.07
160	270	49	45	38	4	3	485 000	665 000	1 300	1 800	HR 30230 J	2GB	171	175	256	236	250	7	11	3	2.5	51.3	0.44	1.4	0.76	11.2
	270	77	73	60	4	3	705 000	1 080 000	1 300	1 800	HR 32230 J	4GD	171	171	256	228	254	8	17	3	2.5	64.7	0.44	1.4	0.76	17.8
	320	72	65	55	5	4	690 000	860 000	1 100	1 500	30330	—	177	193	302	275	292	8	17	4	3	61.4	0.36	1.7	0.92	24.2
	320	72	65	55	5	4	825 000	1 060 000	1 100	1 600	HR 30330 J	2GB	177	190	302	276	292	8	17	4	3	60.0	0.35	1.7	0.96	25
	320	82	75	50	5	4	790 000	1 100 000	1 000	1 400	HR 31330 J	7GB	194	187	302	253	300	9	32	4	3	99.3	0.83	0.73	0.40	28.5
	320	114	108	90	5	4	1 120 000	1 700 000	1 100	1 500	32330	—	182	191	302	262	297	8	24	4	3	81.5	0.37	1.6	0.88	41.4
	220	38	38	30	2.5	2	296 000	570 000	1 400	1 900	HR 32932 J	2DC	175	173	208	206	212	7	8	2	2	38.7	0.35	1.7	0.95	4.32
	240	51	51	38	3	2.5	425 000	750 000	1 300	1 800	HR 32032 XJ	4EC	178	175	228	216	231	8	13	2.5	2	53.0	0.46	1.3	0.72	7.93
	290	52	48	40	4	3	530 000	730 000	1 200	1 600	HR 30232 J	4GB	181	189	276	253	269	8	12	3	2.5	55.0	0.44	1.4	0.76	13.7
	290	84	80	67	4	3	795 000	1 220 000	1 200	1 600	HR 32232 J	4GD	181	184	276	243	274	10	17	3	2.5	70.5	0.44	1.4	0.76	22.5
170	340	75	68	58	5	4	765 000	960 000	1 000	1 400	30332	—	187	205	322	293	311	10	17	4	3	64.6	0.36	1.7	0.92	28.4
	340	75	68	58	5	4	915 000	1 180 000	1 100	1 400	HR 30332 J	2GB	187	201	322	293	310	10	17	4	3	62.9	0.35	1.7	0.96	29.7
	340	75	68	48	5	4	675 000	875 000	950	1 300	30332 D	—	196	198	322	270	313	9	27	4	3	99.4	0.81	0.74	0.41	27.5
	340	121	114	95	5	4	1 210 000	1 770 000	1 000	1 400	32332	—	192	202	322	281	319	10	26	4	3	87.1	0.37	1.6	0.88	48.3
	230	38	36	31	2.5	2.5	258 000	485 000	1 300	1 800	32934	—	185	183	220	216	223	7	7	2	2	41.6	0.36	1.7	0.90	4.3
	230	38	38	30	2.5	2	294 000	560 000	1 400	1 800	HR 30234 J	3DC	185	180	218	215	222	7	8	2	2	41.7	0.38	1.6	0.86	4.44
	260	57	57	43	3	2.5	505 000	890 000	1 200	1 700	HR 32034 XJ	4EC	188	187	248	232	249	10	14	2.5	2	56.6	0.44	1.4	0.74	10.6
	310	57	52	43	5	4	630 000	885 000	1 100	1 500	HR 30234 J	4GB	197	202	292	273	288	8	14	4	3	59.4	0.44	1.4	0.76	17.1
	310	91	86	71	5	4	930 000	1 450 000	1 100	1 500	HR 32234 J	4GD	197	197	292	262	294	10	20	4	3	76.4	0.44	1.4	0.76	28
	360	80	72	62	5	4	845 000	1 080 000	950	1 300	30334	—	197	221	342	312	332	10	18	4	3	70.1	0.37	1.6	0.90	33.5
360	80	72	62	5	4	960 000	1 230 000	1 000	1 300	HR 30334 J	2GB	197	214	342	310	329	10	18	4	3	67.3	0.35	1.7	0.96	34.5	
360	80	72	50	5	4	760 000	1 040 000	900	1 200	30334 D	—	206	215	342	288	332	10	30	4	3	107.3	0.81	0.74	0.41	33.4	
360	127	120	100	5	4	1 370 000	2 050 000	1 000	1 300	32334	—	202	213	342	297	337	10	27	4	3	91.3	0.37	1.6	0.88	57	

■ SINGLE-ROW TAPERED ROLLER BEARINGS

Bore Diameter 180 – 240 mm

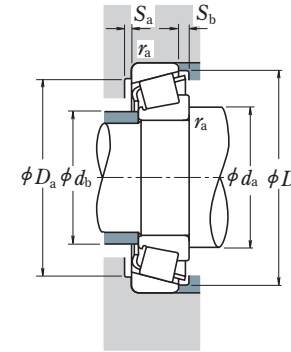
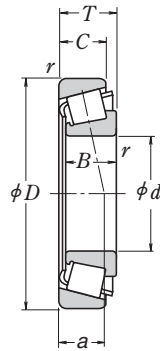

Dynamic Equivalent Load

$$P = XF_r + YF_a$$

$F_a/F_r \leq e$		$F_a/F_r > e$	
X	Y	X	Y
1	0	0.4	Y_1

Static Equivalent Load

$$P_0 = 0.5F_r + Y_0F_a$$

When $F_r > 0.5F_r + Y_0F_a$, use $P_0 = F_r$

The values of e , Y_1 , and Y_0 are given in the table below.

d	Boundary Dimensions (mm)				Ring:		Basic Load Ratings (N)		Limiting Speeds (min ⁻¹)		Bearing Designation	ISO355 Dimension Series approx.	Abutment and Fillet Dimensions (mm)						Ring: Inner Outer	Eff. Load Center (mm) a	Constant e	Axial Load Factors		Mass (kg) approx.		
	D	T	B	C	Inner	Outer	C _r	C _{0r}	Grease	Oil			d _a min.	d _b max.	D _a max.	D _b min.	S _a min.	S _b min.				r _a max.	Y ₁		Y ₀	
180	250	45	45	34	2.5	2	350 000	685 000	1 300	1 700	HR 32936 J HR 32036 XJ HR 30236 J	4DC	195	192	240	227	241	8	11	2	2	53.9	0.48	1.3	0.69	6.56
	280	64	64	48	3	2.5	640 000	1 130 000	1 200	1 600		3FD	198	199	268	248	267	10	16	2.5	2	60.4	0.42	1.4	0.78	14.3
	320	57	52	43	5	4	650 000	930 000	1 100	1 400		4GB	207	210	302	281	297	9	14	4	3	61.8	0.45	1.3	0.73	17.8
	320	91	86	71	5	4	960 000	1 540 000	1 100	1 400	HR 32236 J 30336 30336 D 32336	4GD	207	205	302	270	303	10	20	4	3	78.9	0.45	1.3	0.73	29.8
	380	83	75	64	5	4	935 000	1 230 000	900	1 300		—	207	233	362	324	345	10	19	4	3	72.5	0.36	1.7	0.92	39.3
	380	83	75	53	5	4	820 000	1 120 000	850	1 200		—	216	229	362	304	352	10	30	4	3	113.1	0.81	0.74	0.41	38.5
380	134	126	106	5	4	1 520 000	2 290 000	950	1 300	—		212	225	362	310	353	10	28	4	3	96.6	0.37	1.6	0.88	66.8	
190	260	45	45	34	2.5	2	365 000	715 000	1 200	1 600	HR 32938 J HR 32038 XJ HR 30238 J	4DC	205	201	250	237	251	8	11	2	2	55.3	0.48	1.3	0.69	6.83
	290	64	64	48	3	2.5	650 000	1 170 000	1 100	1 500		4FD	208	209	278	258	279	10	16	2.5	2	63.4	0.44	1.4	0.75	14.9
	340	60	55	46	5	4	715 000	1 020 000	1 000	1 300		4GB	217	223	322	302	318	9	14	4	3	65.6	0.44	1.4	0.76	21.4
	340	97	92	75	5	4	1 110 000	1 770 000	1 000	1 400	HR 32238 J 30338 32338	4GD	217	216	322	290	323	10	22	4	3	80.5	0.44	1.4	0.76	35.2
	400	86	78	65	6	5	1 010 000	1 340 000	850	1 200		—	223	248	378	346	366	11	21	5	4	76.1	0.36	1.7	0.92	46
	400	140	132	109	6	5	1 660 000	2 580 000	850	1 200		—	229	243	378	332	375	11	31	5	4	102.7	0.37	1.6	0.88	78.9
200	280	51	48	41	3	2.5	410 000	780 000	1 100	1 500	32940 HR 32940 J HR 32040 XJ	—	218	217	268	256	269	9	10	2.5	2	53.4	0.37	1.6	0.88	9.26
	280	51	51	39	3	2.5	480 000	935 000	1 100	1 500		3EC	218	216	268	258	271	9	12	2.5	2	54.2	0.39	1.5	0.84	9.65
	310	70	70	53	3	2.5	760 000	1 370 000	1 000	1 400		4FD	218	221	298	277	297	11	17	2.5	2	67.4	0.43	1.4	0.77	18.9
	360	64	58	48	5	4	795 000	1 120 000	950	1 300	HR 30240 J HR 32240 J 30340	4GB	227	236	342	318	336	10	16	4	3	69.1	0.44	1.4	0.76	25.5
	360	104	98	82	5	4	1 210 000	1 920 000	950	1 300		3GD	227	230	342	305	340	11	22	4	3	85.1	0.41	1.5	0.81	42.6
	420	89	80	67	6	5	1 030 000	1 390 000	850	1 200		—	233	253	398	346	368	11	22	5	4	81.4	0.37	1.6	0.88	52.3
420	89	80	56	6	5	965 000	1 330 000	750	1 000	30340 D 32340	—	244	253	398	336	385	11	33	5	4	122.9	0.81	0.74	0.41	49.6	
420	146	138	115	6	5	1 820 000	2 870 000	800	1 100		—	239	253	398	346	392	11	31	5	4	106.7	0.37	1.6	0.88	90.9	
220	300	51	51	39	3	2.5	490 000	990 000	1 000	1 400	HR 32944 J HR 32044 XJ 30244	3EC	238	235	288	278	293	9	12	2.5	2	59.2	0.43	1.4	0.78	10.3
	340	76	76	57	4	3	885 000	1 610 000	950	1 300		4FD	241	244	326	303	326	12	19	3	2.5	73.6	0.43	1.4	0.77	24.4
	400	72	65	54	5	4	810 000	1 150 000	850	1 100		—	247	267	382	350	367	11	18	4	3	74.7	0.40	1.5	0.82	33.6
	400	114	108	90	5	4	1 340 000	2 210 000	850	1 100	32244 30344 32344	—	247	260	382	340	377	12	24	4	3	93.0	0.40	1.5	0.82	57.4
	460	97	88	73	6	5	1 430 000	1 990 000	750	1 000		—	253	283	438	390	414	12	24	5	4	85.4	0.36	1.7	0.92	72.4
	460	154	145	122	6	5	2 020 000	3 200 000	750	1 000		—	259	274	438	372	421	12	32	5	4	114.9	0.37	1.6	0.88	114
240	320	51	51	39	3	2.5	500 000	1 040 000	950	1 300	HR 32948 J HR 32048 XJ 30248	4EC	258	255	308	297	314	9	12	2.5	2	65.1	0.46	1.3	0.72	11.1
	360	76	76	57	4	3	920 000	1 730 000	850	1 200		4FD	261	262	346	321	346	12	19	3	2.5	79.1	0.46	1.3	0.72	26.2
	440	79	72	60	5	4	990 000	1 400 000	750	1 000		—	267	288	422	384	408	11	19	4	3	85.1	0.44	1.4	0.74	45.2
	440	127	120	100	5	4	1 630 000	2 730 000	750	1 000	32248 30348 32348	—	267	285	422	374	416	12	27	4	3	102.5	0.40	1.5	0.82	78
	500	105	95	80	6	5	1 660 000	2 340 000	670	950		—	273	308	478	422	447	12	25	5	4	92.8	0.36	1.7	0.92	92.6
	500	165	155	132	6	5	2 520 000	4 100 000	670	900		—	279	301	478	410	464	12	33	5	4	123.2	0.37	1.6	0.88	145

SINGLE-ROW TAPERED ROLLER BEARINGS

Bore Diameter 260 – 440 mm

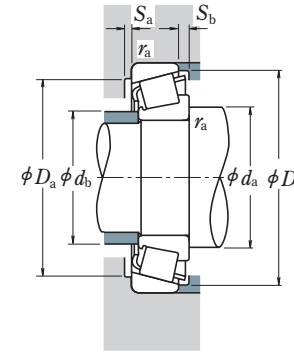
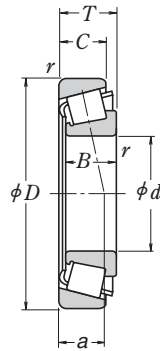

Dynamic Equivalent Load

$$P = XF_r + YF_a$$

$F_a/F_r \leq e$		$F_a/F_r > e$	
X	Y	X	Y
1	0	0.4	Y_1

Static Equivalent Load

$$P_0 = 0.5F_r + Y_0F_a$$

When $F_r > 0.5F_r + Y_0F_a$, use $P_0 = F_r$

The values of e , Y_1 , and Y_0 are given in the table below.

d	Boundary Dimensions (mm)				Ring:		Basic Load Ratings (N)		Limiting Speeds (min ⁻¹)		Bearing Designation	ISO355 Dimension Series approx.	Abutment and Fillet Dimensions (mm)						Ring: Inner Outer	Eff. Load Center (mm) a	Constant e	Axial Load Factors		Mass (kg) approx.		
	D	T	B	C	Inner	Outer	C _r	C _{0r}	Grease	Oil			d _a min.	d _b max.	D _a max.	D _b min.	S _a min.	S _b min.				r _a max.	Y ₁		Y ₀	
260	360	63.5	63.5	48	3	2.5	730 000	1 450 000	850	1 100	HR 32952 J HR 32052 XJ 30252	3EC	278	278	348	333	347	11	15.5	2.5	2	69.8	0.41	1.5	0.81	18.6
	400	87	87	65	5	4	1 160 000	2 160 000	800	1 100		4FC	287	287	382	357	383	14	22	4	3	86.3	0.43	1.4	0.76	38.5
	480	89	80	67	6	5	1 190 000	1 700 000	670	900		—	293	316	458	421	447	12	22	5	4	94.6	0.44	1.4	0.74	60.7
	480	137	130	106	6	5	1 900 000	3 300 000	670	950	32252 30352 32352	—	293	305	458	394	446	14	31	5	4	116.0	0.45	1.3	0.73	103
	540	113	102	85	6	6	1 870 000	2 640 000	630	850		—	293	336	512	460	487	16	28	5	5	101.6	0.36	1.7	0.92	114
	540	176	165	136	6	6	2 910 000	4 800 000	630	850		—	293	328	512	441	495	13	40	5	5	130.5	0.37	1.6	0.88	188
280	380	63.5	63.5	48	3	2.5	765 000	1 580 000	800	1 100	HR 32956 J HR 32056 XJ 30256	4EC	298	297	368	352	368	12	15.5	2.5	2	75.3	0.43	1.4	0.76	20
	420	87	87	65	5	4	1 180 000	2 240 000	710	1 000		4FC	307	305	402	374	402	14	22	4	3	91.6	0.46	1.3	0.72	40.6
	500	89	80	67	6	5	1 240 000	1 900 000	630	850		—	313	339	478	436	462	12	22	5	4	98.5	0.44	1.4	0.74	66.3
	500	137	130	106	6	5	1 950 000	3 450 000	630	850	32256 32356	—	313	325	478	412	467	14	31	5	4	123.1	0.47	1.3	0.70	109
	580	187	175	145	6	6	3 300 000	5 400 000	560	800		—	319	353	552	475	532	14	42	5	5	139.6	0.37	1.6	0.89	224
	500	137	130	106	6	5	1 950 000	3 450 000	630	850		32960 HR 32960 J HR 32060 XJ	—	321	326	406	386	405	13	14	3	2.5	79.3	0.37	1.6	0.88
420	76	76	57	4	3	1 010 000	2 100 000	710	950	3FD	321		324	406	387	405	13	19	3	2.5	79.9	0.39	1.5	0.84	31.4	
460	100	100	74	5	4	1 440 000	2 700 000	670	900	4GD	327		330	442	408	439	15	26	4	3	98.4	0.43	1.4	0.76	56.6	
540	96	85	71	6	5	1 440 000	2 100 000	600	800	30260 32260	—	333	355	518	470	499	14	25	5	4	105.1	0.44	1.4	0.74	80.6	
540	149	140	115	6	5	2 220 000	3 700 000	600	800		—	333	352	518	458	514	15	34	5	4	131.7	0.46	1.3	0.72	132	
540	149	140	115	6	5	2 220 000	3 700 000	600	800		32964 HR 32964 J HR 32064 XJ	—	341	345	426	404	425	13	13	3	2.5	84.3	0.39	1.5	0.84	32
440	76	76	57	4	3	1 040 000	2 220 000	670	900	3FD		341	344	426	406	426	13	19	3	2.5	85.0	0.42	1.4	0.79	33.3	
480	100	100	74	5	4	1 510 000	2 910 000	630	850	4GD		347	350	462	430	461	15	26	4	3	104.5	0.46	1.3	0.72	60	
580	104	92	75	6	5	1 640 000	2 420 000	530	750	30264 32264 32364	—	353	381	558	503	533	14	29	5	4	113.7	0.44	1.4	0.74	99.3	
580	159	150	125	6	5	2 860 000	5 050 000	530	750		—	353	383	558	487	550	15	34	5	4	141.7	0.46	1.3	0.72	175	
670	210	200	170	7.5	7.5	4 200 000	7 100 000	480	670		—	383	412	634	547	616	14	42	6	6	157.5	0.37	1.6	0.88	343	
340	460	76	72	63	4	3	910 000	1 940 000	630	850	32968 HR 32968 J 32068	—	361	364	446	426	446	13	13	3	2.5	89.2	0.41	1.5	0.80	33.6
	460	76	76	57	4	3	1 050 000	2 220 000	630	850		4FD	361	362	446	427	446	13	19	3	2.5	91.0	0.44	1.4	0.75	34.3
	520	112	106	92	6	5	1 650 000	3 400 000	560	750		—	373	386	498	464	496	3.5	22	5	4	104.5	0.37	1.6	0.89	83.7
360	480	76	72	62	4	3	945 000	2 100 000	600	800	32972 HR 32972 J 32072	—	381	386	466	445	465	14	14	3	2.5	91.4	0.40	1.5	0.82	35.8
	480	76	76	57	4	3	1 080 000	2 340 000	560	800		4FD	381	381	466	445	466	13	19	3	2.5	96.8	0.46	1.3	0.72	36.1
	540	112	106	92	6	5	1 680 000	3 500 000	530	750		—	393	402	518	480	514	5.5	22	5	4	108.6	0.38	1.6	0.86	86.5
380	520	87	82	71	5	4	1 210 000	2 550 000	560	750	32976	—	407	406	502	478	501	16	16	4	3	95.2	0.39	1.6	0.86	49.5
400	540	87	82	71	5	4	1 250 000	2 700 000	530	710	32980 32080	—	427	428	522	499	524	16	16	4	3	100.8	0.40	1.5	0.82	52.7
	600	125	118	100	6	5	1 960 000	4 050 000	480	670		—	433	443	578	533	565	5	25	5	4	115.3	0.36	1.7	0.92	116
420	560	87	82	72	5	4	1 300 000	2 810 000	500	670	32984 32084	—	447	448	542	521	544	3.5	15	4	3	106.1	0.41	1.5	0.81	54.8
	620	125	118	100	6	5	2 000 000	4 200 000	450	630		—	453	463	598	552	586	6.5	25	5	4	120.0	0.37	1.6	0.88	121
440	650	130	122	104	6	6	2 230 000	4 600 000	430	600	32088	—	473	487	622	582	616	5	26	5	5	126.3	0.36	1.7	0.92	136

■ SINGLE-ROW TAPERED ROLLER BEARINGS (INCH SERIES)

Bore Diameter 12.000 – 22.225 mm

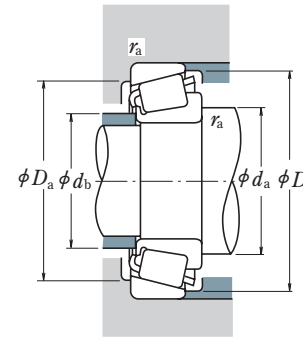
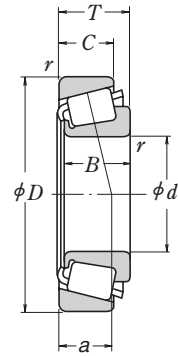

Dynamic Equivalent Load

$$P = XF_r + YF_a$$

$F_a/F_r \leq e$		$F_a/F_r > e$	
X	Y	X	Y
1	0	0.4	Y_1

Static Equivalent Load

$$P_0 = 0.5F_r + Y_0F_a$$

When $F_r > 0.5F_r + Y_0F_a$, use $P_0 = F_r$

The values of e , Y_1 , and Y_0 are given in the table below.

Boundary Dimensions (mm)					Ring:		Basic Load Ratings (N)		Limiting Speeds (min^{-1})		Bearing Designations		Abutment and Fillet Dimensions (mm)				Eff. Load Center (mm)	Constant	Axial Load Factors		Mass (kg)					
d	D	T	B	C	Inner	Outer	C_r	C_{Or}	Grease	Oil	INNER RING	OUTER RING	d_a	d_b	D_a	D_b	r_a	a	e	Y_1	Y_0	approx.	Inner	Outer	Ring	
12.000	31.991	10.008	10.785	7.938	0.8	1.3	10 300	8 900	13 000	18 000	*A 2047	A 2126	16.5	15.5	26	29	0.8	1.3	6.8	0.41	1.5	0.81	0.023	0.017		
12.700	34.988	10.998	10.988	8.730	1.3	1.3	11 700	10 900	12 000	16 000	A 4050	A 4138	18.5	17	29	32	1.3	1.3	8.2	0.45	1.3	0.73	0.033	0.022		
15.000	34.988	10.998	10.988	8.730	0.8	1.3	11 700	10 900	12 000	16 000	*A 4059	A 4138	19.5	19	29	32	0.8	1.3	8.2	0.45	1.3	0.73	0.029	0.022		
15.875	34.988	10.998	10.998	8.712	1.3	1.3	13 800	13 400	11 000	15 000	L 21549	L 21511	21.5	19.5	29	32.5	1.3	1.3	7.7	0.32	1.9	1.0	0.031	0.018		
	39.992	12.014	11.153	9.525	1.3	1.3	14 900	15 700	9 500	13 000	A 6062	A 6157	22	20.5	34	37	1.3	1.3	10.3	0.53	1.1	0.63	0.044	0.031		
	41.275	14.288	14.681	11.112	1.3	2.0	21 300	19 900	10 000	13 000	03062	03162	21.5	20	34	37.5	1.3	2	9.1	0.31	1.9	1.1	0.061	0.035		
	42.862	14.288	14.288	9.525	1.5	1.5	17 300	17 200	8 500	12 000	11590	11520	24.5	22.5	34.5	39.5	1.5	1.5	13.0	0.70	0.85	0.47	0.061	0.040		
	42.862	16.670	16.670	13.495	1.5	1.5	26 900	26 300	9 500	13 000	17580	17520	23	21	36.5	39	1.5	1.5	10.6	0.33	1.8	1.0	0.075	0.048		
	44.450	15.494	14.381	11.430	1.5	1.5	23 800	23 900	8 500	11 000	05062	05175	23.5	21	38	42	1.5	1.5	11.2	0.36	1.7	0.93	0.081	0.039		
	49.225	19.845	21.539	14.288	0.8	1.3	37 500	37 000	8 500	11 000	09062	09195	22	21.5	42	44.5	0.8	1.3	10.7	0.27	2.3	1.2	0.139	0.065		
	16.000	47.000	21.000	21.000	16.000	1.0	2.0	35 000	36 500	9 000	12 000	*HM 81649	**HM 81610	27.5	23	37.5	43	1	2	14.9	0.55	1.1	0.60	0.115	0.082	
		39.992	12.014	11.153	9.525	0.8	1.3	14 900	15 700	9 500	13 000	A 6067	A 6157	22	21	34	37	0.8	1.3	10.3	0.53	1.1	0.63	0.042	0.031	
		36.525	11.112	11.112	7.938	1.5	1.5	11 600	11 000	10 000	14 000	A 5069	A 5144	23.5	21.5	30	33.5	1.5	1.5	8.9	0.49	1.2	0.68	0.030	0.020	
	17.462	39.878	13.843	14.605	10.668	1.3	1.3	22 500	22 500	10 000	13 000	† LM 11749	† LM 11710	23	21.5	34	37	1.3	1.3	8.7	0.29	2.1	1.2	0.055	0.028	
		47.000	14.381	14.381	11.112	0.8	1.3	23 800	23 900	8 500	11 000	05068	05185	23	22.5	40.5	42.5	0.8	1.3	10.1	0.36	1.7	0.93	0.082	0.047	
19.050	39.992	12.014	11.153	9.525	1.0	1.3	14 900	15 700	9 500	13 000	A 6075	A 6157	24	23	34	37	1	1.3	10.3	0.53	1.1	0.63	0.078	0.031		
	45.237	15.494	16.637	12.065	1.3	1.3	28 500	28 900	9 000	12 000	† LM 11949	† LM 11910	25	23.5	39.5	41.5	1.3	1.3	9.5	0.30	2.0	1.1	0.081	0.044		
	47.000	14.381	14.381	11.112	1.3	1.3	23 800	23 900	8 500	11 000	05075	05185	25	23.5	40.5	42.5	1.3	1.3	10.1	0.36	1.7	0.93	0.077	0.047		
	49.225	18.034	19.050	14.288	1.3	1.3	37 500	37 000	8 500	11 000	09067	09195	25.5	24	42	44.5	1.3	1.3	10.7	0.27	2.3	1.2	0.115	0.065		
	49.225	19.845	21.539	14.288	1.2	1.3	37 500	37 000	8 500	11 000	09078	09195	25.5	24	42	44.5	1.2	1.3	10.7	0.27	2.3	1.2	0.124	0.065		
	49.225	21.209	19.050	17.462	1.3	1.5	37 500	37 000	8 500	11 000	09067	09196	25.5	24	41.5	44.5	1.5	1.5	13.8	0.27	2.3	1.2	0.115	0.085		
19.990	49.225	23.020	21.539	17.462	C1.5	3.5	37 500	37 000	8 500	11 000	09074	09194	26	24	39	44.5	1.5	3.5	13.8	0.27	2.3	1.2	0.124	0.082		
	53.975	22.225	21.839	15.875	1.5	2.3	40 500	39 500	7 500	10 000	21075	21212	31.5	26	43	50	1.5	2.3	16.3	0.59	1.0	0.56	0.156	0.097		
	47.000	14.381	14.381	11.112	1.5	1.3	23 800	23 900	8 500	11 000	05079	05185	26.5	24	40.5	42.5	1.5	1.3	10.1	0.36	1.7	0.93	0.073	0.047		
	51.994	15.011	14.260	12.700	1.5	1.3	26 000	27 900	7 500	10 000	07079	07204	27.5	27	45	48	1.5	1.3	12.1	0.40	1.5	0.82	0.105	0.061		
20.625	49.225	23.020	21.539	17.462	1.5	1.5	37 500	37 000	8 500	11 000	09081	09196	27.5	25.5	41.5	44.5	1.5	1.5	13.8	0.27	2.3	1.2	0.115	0.085		
20.638	49.225	19.845	19.845	15.875	1.5	1.5	36 000	37 000	8 000	11 000	12580	12520	28.5	26	42.5	45.5	1.5	1.5	12.9	0.32	1.9	1.0	0.114	0.067		
21.430	50.005	17.526	18.288	13.970	1.3	1.3	38 500	40 000	8 000	11 000	† M 12649	† M 12610	27.5	25.5	44	46	1.3	1.3	10.9	0.28	2.2	1.2	0.115	0.059		
22.000	45.237	15.494	16.637	12.065	1.3	1.3	29 200	33 500	8 500	11 000	*† LM 12749	† LM 12710	27.5	26	39.5	42.5	1.3	1.3	10.0	0.31	2.0	1.1	0.078	0.038		
	45.975	15.494	16.637	12.065	1.3	1.3	29 200	33 500	8 500	11 000	*† LM 12749	† LM 12711	27.5	26	40	42.5	1.3	1.3	10.0	0.31	2.0	1.1	0.078	0.043		
22.225	50.005	13.495	14.260	9.525	1.3	1.0	26 000	27 900	7 500	10 000	07087	07196	28.5	27	44.5	47	1.3	1	10.6	0.40	1.5	0.82	0.097	0.035		
	50.005	17.526	18.288	13.970	1.3	1.3	38 500	40 000	8 000	11 000	† M 12648	† M 12610	28.5	26.5	44	46	1.3	1.3	10.9	0.28	2.2	1.2	0.111	0.059		
	52.388	19.368	20.168	14.288	1.5	1.5	40 500	43 000	7 500	10 000	1380	1328	29.5	27	45	48.5	1.5	1.5	11.3	0.29	2.1	1.1	0.137	0.067		
	53.975	19.368	20.168	14.288	1.5	1.5	40 500	43 000	7 500	10 000	1380	1329	29.5	27	46	49	1.5	1.5	11.3	0.29	2.1	1.1	0.137	0.082		
	56.896	19.368	19.837	15.875	1.3	1.3	38 000	40 500	7 100	9 500	1755	1729	29	27.5	49	51	1.3	1.3	12.2	0.31	2.0	1.1	0.152	0.102		
	57.150	22.225	22.225	17.462	0.8	1.5	48 000	50 000	7 100	9 500	1280	1220	29.5	29	49	52	0.8	1.5	15.1	0.35	1.7	0.95	0.183	0.106		

- Notes**
- * The maximum bore diameter is listed and its tolerance is negative (see Table 7.4.1 on Page A136).
 - ** The maximum outside diameter is listed and its tolerance is negative (see Table 7.4.2 on Pages A136 and A137).
 - † The tolerances for the bore diameter and overall bearing width differ from the standard (see Table 5 on Page C185).
 - * † The tolerance for the bore diameter is 0 to -20 μm, and the tolerance for overall bearing width is +356 to 0 μm.

■ SINGLE-ROW TAPERED ROLLER BEARINGS (INCH SERIES)

Bore Diameter 22.606 – 28.575 mm

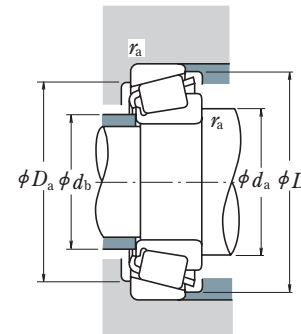
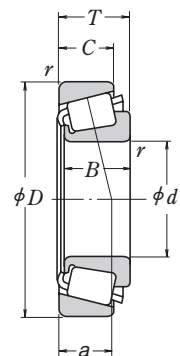

Dynamic Equivalent Load

$P = XF_r + YF_a$

$F_a/F_r \leq e$		$F_a/F_r > e$	
X	Y	X	Y
1	0	0.4	Y_1

Static Equivalent Load

$P_0 = 0.5F_r + Y_0F_a$

When $F_r > 0.5F_r + Y_0F_a$, use $P_0 = F_r$

The values of e , Y_1 , and Y_0 are given in the table below.

Boundary Dimensions (mm)					Ring:		Basic Load Ratings (N)		Limiting Speeds (min ⁻¹)		Bearing Designations		Abutment and Fillet Dimensions (mm)					Eff. Load Center (mm)	Constant	Axial Load Factors		Mass (kg)		
<i>d</i>	<i>D</i>	<i>T</i>	<i>B</i>	<i>C</i>	Inner	Outer	<i>C_r</i>	<i>C_{0r}</i>	Grease	Oil	INNER RING	OUTER RING	<i>d_a</i>	<i>d_b</i>	<i>D_a</i>	<i>D_b</i>	Cone	Cup	<i>a</i>	<i>e</i>	<i>Y₁</i>	<i>Y₀</i>	approx. Inner Ring Outer Ring	
					<i>r</i> min.																			
22.606	47.000	15.500	15.500	12.000	1.5	1.0	26 300	30 000	8 000	11 000	LM 72849	LM 72810	29	27	40.5	44.5	1.5	1	12.2	0.47	1.3	0.70	0.086	0.046
23.812	50.292	14.224	14.732	10.668	1.5	1.3	27 600	32 000	7 100	10 000	† L 44640	† L 44610	30.5	28.5	44.5	47	1.5	1.3	10.9	0.37	1.6	0.88	0.097	0.039
	56.896	19.368	19.837	15.875	0.8	1.3	38 000	40 500	7 100	9 500	1779	1729	29.5	28.5	49	51	0.8	1.3	12.2	0.31	2.0	1.1	0.143	0.102
24.000	55.000	25.000	25.000	21.000	2.0	2.0	49 500	55 000	7 100	9 500	▲ JHM 33449	▲ JHM 33410	35	30	47	52	2	2	15.8	0.35	1.7	0.93	0.181	0.107
24.981	51.994	15.011	14.260	12.700	1.5	1.3	26 000	27 900	7 500	10 000	07098	07204	31	29	45	48	1.5	1.3	12.1	0.40	1.5	0.82	0.085	0.061
	52.001	15.011	14.260	12.700	1.5	2.0	26 000	27 900	7 500	10 000	07098	07205	31	29	44.5	48	1.5	2	12.1	0.40	1.5	0.82	0.085	0.061
	62.000	16.002	16.566	14.288	1.5	1.5	37 000	39 500	6 300	8 500	17098	17244	33	30.5	54	57	1.5	1.5	12.8	0.38	1.6	0.86	0.165	0.091
25.000	50.005	13.495	14.260	9.525	1.5	1.0	26 000	27 900	7 500	10 000	07097	07196	31	29	44.5	47	1.5	1	10.6	0.40	1.5	0.82	0.085	0.035
	51.994	15.011	14.260	12.700	1.5	1.3	26 000	27 900	7 500	10 000	07097	07204	31	29	45	48	1.5	1.3	12.1	0.40	1.5	0.82	0.085	0.061
25.400	50.005	13.495	14.260	9.525	3.3	1.0	26 000	27 900	7 500	10 000	07100 SA	07196	35	29.5	44.5	47	3.3	1	10.6	0.40	1.5	0.82	0.082	0.035
	50.005	13.495	14.260	9.525	1.0	1.0	26 000	27 900	7 500	10 000	07100	07196	30.5	29.5	44.5	47	1	1	10.6	0.40	1.5	0.82	0.084	0.035
	50.292	14.224	14.732	10.668	1.3	1.3	27 600	32 000	7 100	10 000	† L 44643	† L 44610	31.5	29.5	44.5	47	1.3	1.3	10.9	0.37	1.6	0.88	0.090	0.039
	57.150	17.462	17.462	13.495	1.3	1.5	39 500	45 500	6 700	9 000	15578	15520	32.5	30.5	51	53	1.3	1.5	12.4	0.35	1.7	0.95	0.151	0.070
	57.150	19.431	19.431	14.732	1.5	1.5	42 500	49 000	6 700	9 000	M 84548	M 84510	36	33	48.5	54	1.5	1.5	16.1	0.55	1.1	0.60	0.156	0.089
	59.530	23.368	23.114	18.288	0.8	1.5	50 000	58 000	6 300	9 000	M 84249	M 84210	36	32.5	49.5	56	0.8	1.5	18.3	0.55	1.1	0.60	0.194	0.13
	62.000	19.050	20.638	14.288	0.8	1.3	46 000	53 000	6 000	8 000	15101	15245	32.5	31.5	55	58	0.8	1.3	13.3	0.35	1.7	0.94	0.222	0.081
26.988	63.500	20.638	20.638	15.875	3.5	1.5	46 000	53 000	6 000	8 000	15100	15250 X	38	31.5	55	59	3.5	1.5	14.9	0.35	1.7	0.94	0.22	0.113
	64.292	21.433	21.433	16.670	1.5	1.5	51 000	64 500	5 600	8 000	M 86643	M 86610	38	36.5	54	61	1.5	1.5	17.7	0.55	1.1	0.60	0.246	0.128
	65.088	22.225	21.463	15.875	1.5	1.5	45 000	47 500	5 600	8 000	23100	23256	39	34.5	53	61	1.5	1.5	20.0	0.73	0.82	0.45	0.214	0.142
	68.262	22.225	22.225	17.462	0.8	1.5	55 000	64 000	5 600	7 500	02473	02420	34.5	33.5	59	63	0.8	1.5	16.9	0.42	1.4	0.79	0.28	0.152
	72.233	25.400	25.400	19.842	0.8	2.3	63 500	83 500	5 000	7 100	HM 88630	HM 88610	39.5	39.5	60	69	0.8	2.3	20.7	0.55	1.1	0.60	0.398	0.188
	72.626	24.608	24.257	17.462	2.3	1.5	60 000	58 000	5 600	7 500	41100	41286	41	36.5	61	68	2.3	1.5	20.7	0.60	1.0	0.55	0.32	0.177
	50.292	14.224	14.732	10.668	3.5	1.3	27 600	32 000	7 100	10 000	† L 44649	† L 44610	37.5	31	44.5	47	3.5	1.3	10.9	0.37	1.6	0.88	0.081	0.039
	57.150	19.845	19.355	15.875	3.3	1.5	40 000	44 500	6 700	9 000	1997 X	1922	37.5	31.5	51	53.5	3.3	1.5	13.9	0.33	1.8	1.0	0.152	0.077
	60.325	19.842	17.462	15.875	3.5	1.5	39 500	45 500	6 700	9 000	15580	15523	38.5	32	51	54	3.5	1.5	14.7	0.35	1.7	0.95	0.141	0.123
	62.000	19.050	20.638	14.288	0.8	1.3	46 000	53 000	6 000	8 000	15106	15245	33.5	33	55	58	0.8	1.3	13.3	0.35	1.7	0.94	0.211	0.081
28.575	57.150	19.845	19.355	15.875	3.5	1.5	40 000	44 500	6 700	9 000	1988	1922	39.5	33.5	51	53.5	3.5	1.5	13.9	0.33	1.8	1.0	0.141	0.077
	59.131	15.875	16.764	11.811	spec.	1.3	34 500	41 500	6 300	8 500	† LM 67043	† LM 67010	40	33.5	52	56	3.5	1.3	12.6	0.41	1.5	0.80	0.147	0.062
	62.000	19.050	20.638	14.288	3.5	1.3	46 000	53 000	6 000	8 000	15112	15245	40	34	55	58	3.5	1.3	13.3	0.35	1.7	0.94	0.199	0.081
	62.000	19.050	20.638	14.288	0.8	1.3	46 000	53 000	6 000	8 000	15113	15245	34.5	34	55	58	0.8	1.3	13.3	0.35	1.7	0.94	0.20	0.081
	64.292	21.433	21.433	16.670	1.5	1.5	51 000	64 500	5 600	8 000	M 86647	M 86610	40	38	54	61	1.5	1.5	17.7	0.55	1.1	0.60	0.223	0.128
	68.262	22.225	22.225	17.462	0.8	1.5	55 000	64 000	5 600	7 500	02474	02420	36.5	36	59	63	0.8	1.5	16.9	0.42	1.4	0.79	0.257	0.152
	72.626	24.608	24.257	17.462	4.8	1.5	60 000	58 000	5 600	7 500	41125	41286	48	36.5	61	68	4.8	1.5	20.7	0.60	1.0	0.55	0.292	0.177
	72.626	24.608	24.257	17.462	1.5	1.5	60 000	58 000	5 600	7 500	41126	41286	41.5	36.5	61	68	1.5	1.5	20.7	0.60	1.0	0.55	0.295	0.177
	73.025	22.225	22.225	17.462	0.8	3.3	54 500	64 500	5 300	7 100	02872	02820	37.5	37	62	68	0.8	3.3	18.3	0.45	1.3	0.73	0.321	0.16

Notes † The tolerances for the bore diameter and overall bearing width differ from the standard (see Table 5 on Page C185).
▲ Tolerances are listed in Tables 2, 3, and 4 on Pages C184 and C185.

■ SINGLE-ROW TAPERED ROLLER BEARINGS (INCH SERIES)

Bore Diameter 29.000 – 32.000 mm

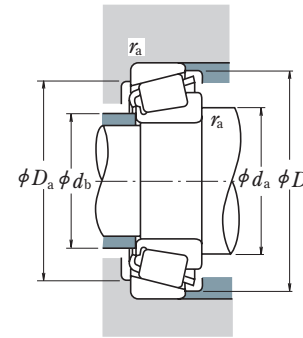
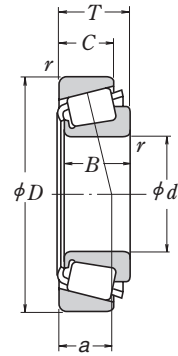

Dynamic Equivalent Load

$$P = XF_r + YF_a$$

$F_a/F_r \leq e$		$F_a/F_r > e$	
X	Y	X	Y
1	0	0.4	Y_1

Static Equivalent Load

$$P_0 = 0.5F_r + Y_0F_a$$

When $F_r > 0.5F_r + Y_0F_a$, use $P_0 = F_r$

The values of e , Y_1 , and Y_0 are given in the table below.

Boundary Dimensions (mm)					Ring:		Basic Load Ratings (N)		Limiting Speeds (min ⁻¹)		Bearing Designations		Abutment and Fillet Dimensions (mm)					Eff. Load Center (mm)	Constant	Axial Load Factors		Mass (kg)			
d	D	T	B	C	Inner	Outer	C_r	C_{Or}	Grease	Oil	INNER RING	OUTER RING	d_a	d_b	D_a	D_b	Inner	Outer	r_a max.	a	e	Y_1	Y_0	approx.	
					r min.	r min.																Inner Ring Outer Ring			
29.000	50.292	14.224	14.732	10.668	3.5	1.3	26 800	34 000	7 100	9 500	† L 45449	† L 45410	39.5	33	44.5	48	3.5	1.3	10.8	0.37	1.6	0.89	0.079	0.036	
29.367	66.421	23.812	25.433	19.050	3.5	1.3	65 000	73 000	6 000	8 000	2690	2631	41	35	58	60	3.5	1.3	14.3	0.25	2.4	1.3	0.242	0.165	
30.000	62.000	16.002	16.566	14.288	1.5	1.5	37 000	39 500	6 300	8 500	* 17118	17244	37	34.5	54	57	1.5	1.5	12.8	0.38	1.6	0.86	0.136	0.091	
	62.000	19.050	20.638	14.288	1.3	1.3	46 000	53 000	6 000	8 000	* 15117	15245	36.5	35	55	58	1.3	1.3	13.3	0.35	1.7	0.94	0.189	0.081	
	63.500	20.638	20.638	15.875	1.3	1.3	46 000	53 000	6 000	8 000	* 15117	15250	36.5	35	56	59	1.3	1.3	14.9	0.35	1.7	0.94	0.189	0.113	
	72.000	19.000	18.923	15.875	1.5	1.5	52 000	56 000	5 600	7 500	* 26118	26283	38	36	62	65	1.5	1.5	14.8	0.36	1.7	0.92	0.225	0.163	
30.112	62.000	19.050	20.638	14.288	0.8	1.3	46 000	53 000	6 000	8 000	15116	15245	36	35.5	55	58	0.8	1.3	13.3	0.35	1.7	0.94	0.189	0.081	
30.162	58.738	14.684	15.080	10.716	3.5	1.0	28 800	33 500	6 000	8 000	08118	08231	41.5	35	52	55	3.5	1	13.3	0.47	1.3	0.70	0.12	0.057	
	64.292	21.433	21.433	16.670	1.5	1.5	51 000	64 500	5 600	8 000	M 86649	M 86610	41	38	54	61	1.5	1.5	17.7	0.55	1.1	0.60	0.211	0.128	
	68.262	22.225	22.225	17.462	2.3	1.5	55 500	70 500	5 300	7 500	M 88043	M 88010	43.5	39.5	58	65	2.3	1.5	19.1	0.55	1.1	0.60	0.263	0.146	
	69.850	23.812	25.357	19.050	2.3	1.3	71 000	84 000	5 600	7 500	2558	2523	40	36.5	61	64	2.3	1.3	14.5	0.27	2.2	1.2	0.297	0.169	
	69.850	23.812	25.357	19.050	0.8	1.3	71 000	84 000	5 600	7 500	2559	2523	37	36.5	61	64	0.8	1.3	14.5	0.27	2.2	1.2	0.298	0.169	
	76.200	24.608	24.074	16.670	1.5	C3.3	67 500	69 500	5 000	6 700	43118	43300	45	42	64	73	1.5	3.3	22.9	0.67	0.90	0.49	0.383	0.146	
30.213	62.000	19.050	20.638	14.288	3.5	1.3	46 000	53 000	6 000	8 000	15118	15245	41.5	35.5	55	58	3.5	1.3	13.3	0.35	1.7	0.94	0.186	0.081	
	62.000	19.050	20.638	14.288	0.8	1.3	46 000	53 000	6 000	8 000	15120	15245	36	35.5	55	58	0.8	1.3	13.3	0.35	1.7	0.94	0.188	0.081	
	62.000	19.050	20.638	14.288	1.5	1.3	46 000	53 000	6 000	8 000	15119	15245	37.5	35.5	55	58	1.5	1.3	13.3	0.35	1.7	0.94	0.188	0.081	
30.955	64.292	21.433	21.433	16.670	1.5	1.5	51 000	64 500	5 600	8 000	M 86648 A	M 86610	42	38	54	61	1.5	1.5	17.7	0.55	1.1	0.60	0.205	0.128	
31.750	58.738	14.684	15.080	10.716	1.0	1.0	28 800	33 500	6 000	8 000	08125	08231	37.5	36	52	55	1	1	13.3	0.47	1.3	0.70	0.113	0.057	
	59.131	15.875	16.764	11.811	spec.	1.3	34 500	41 500	6 300	8 500	† LM 67048	† LM 67010	42.5	36	52	56	3.5	1.3	12.6	0.41	1.5	0.80	0.127	0.062	
	62.000	18.161	19.050	14.288	spec.	1.3	46 000	53 000	6 000	8 000	15123	15245	42.5	36.5	55	58	3.5	1.3	13.3	0.35	1.7	0.94	0.165	0.081	
	62.000	19.050	20.638	14.288	0.8	1.3	46 000	53 000	6 000	8 000	15126	15245	37	36.5	55	58	0.8	1.3	13.3	0.35	1.7	0.94	0.176	0.081	
	62.000	19.050	20.638	14.288	3.5	1.3	46 000	53 000	6 000	8 000	15125	15245	42.5	36.5	55	58	3.5	1.3	13.3	0.35	1.7	0.94	0.174	0.081	
	63.500	20.638	20.638	15.875	0.8	1.3	46 000	53 000	6 000	8 000	15126	15250	37	36.5	56	59	0.8	1.3	14.9	0.35	1.7	0.94	0.176	0.113	
	68.262	22.225	22.225	17.462	3.5	1.5	55 000	64 000	5 600	7 500	02475	02420	44.5	38.5	59	63	3.5	1.5	16.9	0.42	1.4	0.79	0.229	0.152	
	68.262	22.225	22.225	17.462	1.5	1.5	55 500	70 500	5 300	7 500	M 88046	M 88010	43	40.5	58	65	1.5	1.5	19.1	0.55	1.1	0.60	0.25	0.146	
	69.012	19.845	19.583	15.875	3.5	1.3	47 000	56 000	5 600	7 500	14125 A	14276	44	37.5	60	63	3.5	1.3	15.3	0.38	1.6	0.86	0.219	0.135	
	69.012	26.982	26.721	15.875	4.3	3.3	47 000	56 000	5 600	7 500	14123 A	14274	41.5	37.5	59	63	4.3	3.3	15.1	0.38	1.6	0.87	0.289	0.132	
	69.850	23.812	25.357	19.050	0.8	1.3	71 000	84 000	5 600	7 500	2580	2523	38.5	37.5	61	64	0.8	1.3	14.5	0.27	2.2	1.2	0.282	0.169	
	69.850	23.812	25.357	19.050	3.5	1.3	71 000	84 000	5 600	7 500	2582	2523	44	37.5	61	64	3.5	1.3	14.5	0.27	2.2	1.2	0.28	0.169	
	72.626	30.162	29.997	23.812	0.8	3.3	79 500	90 000	5 300	7 500	3188	3120	39.5	39.5	61	67	0.8	3.3	19.6	0.33	1.8	0.99	0.368	0.225	
	73.025	29.370	27.783	23.020	1.3	3.3	74 000	100 000	5 000	7 100	HM 88542	HM 88510	45.5	42.5	59	70	1.3	3.3	23.5	0.55	1.1	0.60	0.379	0.242	
	80.000	21.000	22.403	17.826	0.8	1.3	68 500	75 500	4 500	6 300	346	332	40	39.5	73	75	0.8	1.3	14.6	0.27	2.2	1.2	0.419	0.146	
32.000	72.233	25.400	25.400	19.842	3.3	2.3	63 500	83 500	5 000	7 100	*HM 88638	HM 88610	48.5	42.5	60	69	3.3	2.3	20.7	0.55	1.1	0.60	0.337	0.188	

Notes * The maximum bore diameter is listed and its tolerance is negative (see Table 7.4.1 on Page A136).
† The tolerances for the bore diameter and overall bearing width differ from the standard (see Table 5 on Page C185).

Bore Diameter 33.338 – 35.000 mm

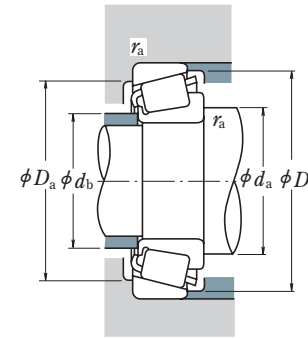
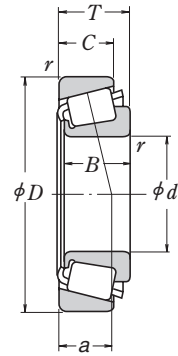

Dynamic Equivalent Load

$$P = X F_r + Y F_a$$

$F_a / F_r \leq e$		$F_a / F_r > e$	
X	Y	X	Y
1	0	0.4	Y_1

Static Equivalent Load

$$P_0 = 0.5 F_r + Y_0 F_a$$

When $F_r > 0.5 F_r + Y_0 F_a$, use $P_0 = F_r$

The values of e , Y_1 , and Y_0 are given in the table below.

<i>d</i>	Boundary Dimensions (mm)					Ring: Inner <i>r</i> Outer <i>r</i> min.	Basic Load Ratings (N)		Limiting Speeds (min ⁻¹)		Bearing Designations		Abutment and Fillet Dimensions (mm)					Eff. Load Center (mm) <i>a</i>	Constant <i>e</i>	Axial Load Factors		Mass (kg)			
	<i>D</i>	<i>T</i>	<i>B</i>	<i>C</i>	<i>C_r</i>		<i>C_{0r}</i>	Grease	Oil	INNER RING	OUTER RING	<i>d_a</i>	<i>d_b</i>	<i>D_a</i>	<i>D_b</i>	Cone <i>r_a</i> max.	Cup <i>r_b</i> max.			<i>Y₁</i>	<i>Y₀</i>	approx.	Inner	Outer	
33.338	66.675	20.638	20.638	15.875	3.5	1.5	46 000	53 500	5 600	7 500	1680	1620	44.5	38.5	58	61	3.5	1.5	15.2	0.37	1.6	0.89	0.196	0.121	
	68.262	22.225	22.225	17.462	0.8	1.5	55 500	70 500	5 300	7 500	M 88048	M 88010	42.5	41	58	65	0.8	1.5	19.0	0.55	1.1	0.60	0.236	0.146	
	69.012	19.845	19.583	15.875	3.5	3.3	47 000	56 000	5 600	7 500	14130	14274	45	38.5	59	63	3.5	3.3	15.3	0.38	1.6	0.86	0.207	0.132	
	69.012	19.845	19.583	15.875	0.8	1.3	47 000	56 000	5 600	7 500	14131	14276	39.5	38.5	60	63	0.8	1.3	15.3	0.38	1.6	0.86	0.209	0.135	
	69.850	23.812	25.357	19.050	3.5	1.3	71 000	84 000	5 600	7 500	2585	2523	45	39	61	64	3.5	1.3	14.5	0.27	2.2	1.2	0.263	0.169	
	72.000	19.000	18.923	15.875	3.5	1.5	52 000	56 000	5 600	7 500	26131	26283	44.5	38.5	62	65	3.5	1.5	14.7	0.36	1.7	0.92	0.20	0.163	
	72.626	30.162	29.997	23.812	0.8	3.3	79 500	90 000	5 300	7 500	3197	3120	41.5	40.5	61	67	0.8	3.3	19.6	0.33	1.8	0.99	0.348	0.225	
	73.025	29.370	27.783	23.020	0.8	3.3	74 000	100 000	5 000	7 100	HM 88547	HM 88510	45.5	42.5	59	70	0.8	3.3	23.5	0.55	1.1	0.60	0.362	0.242	
	76.200	29.370	28.575	23.020	3.8	0.8	78 500	106 000	4 800	6 700	HM 89444	HM 89411	53	44.5	65	73	3.8	0.8	23.6	0.55	1.1	0.60	0.419	0.261	
	76.200	29.370	28.575	23.020	0.8	3.3	78 500	106 000	4 800	6 700	HM 89443	HM 89410	46.5	44.5	62	73	0.8	3.3	23.6	0.55	1.1	0.60	0.421	0.257	
	79.375	25.400	24.074	17.462	3.5	1.5	67 500	69 500	5 000	6 700	43131	43312	51	42	67	74	3.5	1.5	23.7	0.67	0.90	0.49	0.348	0.22	
	34.925	65.088	18.034	18.288	13.970	spec.	1.3	47 500	57 500	5 600	7 500	† LM 48548	† LM 48510	46	40	58	61	3.5	1.3	14.1	0.38	1.6	0.88	0.172	0.087
		65.088	20.320	18.288	16.256	spec.	1.3	47 500	57 500	5 600	7 500	† LM 48548	† LM 48511	46	40	58	61	3.5	1.3	16.4	0.38	1.6	0.88	0.172	0.108
		66.675	20.638	20.638	16.670	3.5	2.3	53 000	62 500	5 600	7 500	M 38549	M 38510	46.5	40	58	62	3.5	2.3	15.2	0.35	1.7	0.94	0.194	0.112
		69.012	19.845	19.583	15.875	3.5	1.3	47 000	56 000	5 600	7 500	14138 A	14276	46	40	60	63	3.5	1.3	15.3	0.38	1.6	0.86	0.194	0.135
		69.012	19.845	19.583	15.875	1.5	1.3	47 000	56 000	5 600	7 500	14137 A	14276	42	40	60	63	1.5	1.3	15.1	0.38	1.6	0.86	0.196	0.135
		72.233	25.400	25.400	19.842	2.3	2.3	63 500	83 500	5 000	7 100	HM 88649	HM 88610	48.5	42.5	60	69	2.3	2.3	20.7	0.55	1.1	0.60	0.307	0.188
73.025		22.225	22.225	17.462	0.8	3.3	54 500	64 500	5 300	7 100	02878	02820	42.5	42	62	68	0.8	3.3	18.3	0.45	1.3	0.73	0.266	0.16	
73.025		22.225	23.812	17.462	3.5	3.3	63 500	77 000	5 300	7 100	2877	2820	47	41.5	63	68	3.5	3.3	16.1	0.37	1.6	0.90	0.291	0.15	
73.025		23.812	24.608	19.050	1.5	0.8	71 000	86 000	5 300	7 100	25877	25821	43	40.5	65	68	1.5	0.8	15.7	0.29	2.1	1.1	0.306	0.167	
73.025		23.812	24.608	19.050	3.5	2.3	71 000	86 000	5 300	7 100	25878	25820	47	40.5	64	68	3.5	2.3	15.7	0.29	2.1	1.1	0.304	0.165	
76.200		29.370	28.575	23.020	0.8	0.8	78 500	106 000	4 800	6 700	HM 89446 A	HM 89411	47.5	44.5	65	73	0.8	0.8	23.6	0.55	1.1	0.60	0.403	0.261	
76.200		29.370	28.575	23.020	3.5	0.8	78 500	106 000	4 800	6 700	HM 89446	HM 89411	53	44.5	65	73	3.5	0.8	23.6	0.55	1.1	0.60	0.40	0.261	
76.200		29.370	28.575	23.020	3.5	3.3	78 500	106 000	4 800	6 700	HM 89446	HM 89410	53	44.5	62	73	3.5	3.3	23.6	0.55	1.1	0.60	0.40	0.257	
76.200		29.370	28.575	23.812	1.5	3.3	80 500	96 500	5 000	6 700	31594	31520	46	43.5	64	72	1.5	3.3	21.6	0.40	1.5	0.82	0.404	0.235	
79.375		29.370	29.771	23.812	3.5	3.3	88 000	106 000	4 800	6 700	3478	3420	50	43.5	67	74	3.5	3.3	20.0	0.37	1.6	0.90	0.448	0.259	
34.976	68.262	15.875	16.520	11.908	1.5	1.5	45 000	53 500	5 300	7 100	19138	19268	42.5	40.5	61	65	1.5	1.5	14.5	0.44	1.4	0.74	0.196	0.073	
	72.085	22.385	19.583	18.415	1.3	2.3	47 000	56 000	5 600	7 500	14139	14283	41.5	40	60	65	1.3	2.3	17.7	0.38	1.6	0.87	0.198	0.21	
	80.000	21.006	20.940	15.875	1.5	1.5	56 500	64 500	5 000	6 700	28138	28315	43.5	41	69	73	1.5	1.5	16.0	0.40	1.5	0.82	0.308	0.199	
35.000	59.131	15.875	16.764	11.938	spec.	1.3	35 000	47 000	6 000	8 000	*† L 68149	† L 68110	45.5	39	52	56	3.5	1.3	13.2	0.42	1.4	0.79	0.117	0.056	
	59.975	15.875	16.764	11.938	spec.	1.3	35 000	47 000	6 000	8 000	*† L 68149	† L 68111	45.5	39	53	56	3.5	1.3	13.2	0.42	1.4	0.79	0.117	0.064	
	62.000	16.700	17.000	13.600	spec.	1.0	38 000	50 000	5 600	8 000	* LM 78349	** LM 78310	46	40	55	59	3.5	1	14.4	0.44	1.4	0.74	0.137	0.074	
	62.000	16.700	17.000	13.600	spec.	1.5	38 000	50 000	5 600	8 000	* LM 78349	** LM 78310 A	46	40	54	59	3.5	1.5	14.4	0.44	1.4	0.74	0.138	0.073	
	65.987	20.638	20.638	16.670	3.5	2.3	53 000	62 500	5 600	7 500	M 38547	M 38511	46	39.5	59	61	3.5	2.3	15.2	0.35	1.7	0.94	0.193	0.103	
	73.025	26.988	26.975	22.225	3.5	0.8	75 500	88 500	5 300	7 500	23691	23621	49	42	63	68	3.5	0.8	18.1	0.37	1.6	0.89	0.309	0.212	

- Notes**
- * The maximum bore diameter is listed and its tolerance is negative (see Table 7.4.1 on Page A136).
 - ** The maximum outside diameter is listed and its tolerance is negative (see Table 7.4.2 on Pages A136 and A137).
 - † The tolerances for the bore diameter and overall bearing width differ from the standard (see Table 5 on Page C185).
 - * † The tolerance for the bore diameter is 0 to -20 μm, and the tolerance for overall bearing width is +356 to 0 μm.

Bore Diameter 35.717 – 41.275 mm

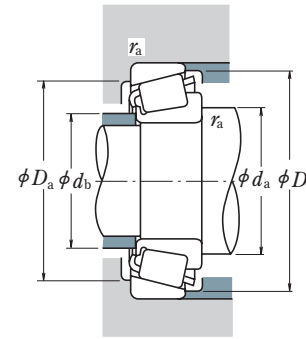
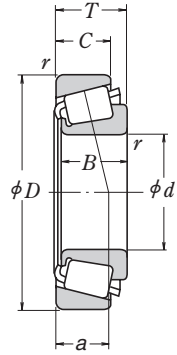

Dynamic Equivalent Load

$$P = XF_r + YF_a$$

$F_a/F_r \leq e$		$F_a/F_r > e$	
X	Y	X	Y
1	0	0.4	Y_1

Static Equivalent Load

$$P_0 = 0.5F_r + Y_0 F_a$$

When $F_r > 0.5F_r + Y_0 F_a$, use $P_0 = F_r$

The values of e , Y_1 , and Y_0 are given in the table below.

Boundary Dimensions (mm)					Ring:		Basic Load Ratings (N)		Limiting Speeds (min ⁻¹)		Bearing Designations		Abutment and Fillet Dimensions (mm)				Eff. Load Center (mm)	Constant	Axial Load Factors		Mass (kg)			
d	D	T	B	C	Inner	Outer	C_r	C_{0r}	Grease	Oil	INNER RING	OUTER RING	d_a	d_b	D_a	D_b	r_a	a	e	Y_1	Y_0	approx. Inner Ring Outer Ring		
					r min.								Ring: Inner Outer max.						Y_1	Y_0				
35.717	72.233	25.400	25.400	19.842	3.5	2.3	63 500	83 500	5 000	7 100	HM 88648	HM 88610	52	43	60	69	3.5	2.3	20.7	0.55	1.1	0.60	0.298	0.188
36.487	73.025	23.812	24.608	19.050	1.5	0.8	71 000	86 000	5 300	7 100	25880	25821	44	42	65	68	1.5	0.8	15.7	0.29	2.1	1.1	0.291	0.167
36.512	76.200	29.370	28.575	23.020	3.5	3.3	78 500	106 000	4 800	6 700	HM 89449	HM 89410	54	44.5	62	73	3.5	3.3	23.6	0.55	1.1	0.60	0.38	0.257
	79.375	29.370	29.771	23.812	0.8	3.3	88 000	106 000	4 800	6 700	3479	3420	45.5	44.5	67	74	0.8	3.3	20.0	0.37	1.6	0.90	0.429	0.259
	88.501	25.400	23.698	17.462	2.3	1.5	73 000	81 000	4 000	5 600	44143	44348	54	50	75	84	2.3	1.5	27.9	0.78	0.77	0.42	0.502	0.245
	93.662	31.750	31.750	26.195	1.5	3.3	110 000	142 000	4 000	5 600	46143	46368	48.5	46.5	79	87	1.5	3.3	24.0	0.40	1.5	0.82	0.765	0.405
38.000	63.000	17.000	17.000	13.500	spec.	1.3	38 500	52 000	5 600	7 500	▲ JL 69349	▲ JL 69310	49	42.5	56	60	3.5	1.3	14.6	0.42	1.4	0.79	0.132	0.071
38.100	63.500	12.700	11.908	9.525	1.5	0.8	24 100	30 500	5 300	7 100	13889	13830	45	42.5	59	60	1.5	0.8	11.9	0.35	1.7	0.95	0.109	0.046
	65.088	18.034	18.288	13.970	2.3	1.3	42 500	55 000	5 300	7 500	LM 29749	LM 29710	46	42.5	59	62	2.3	1.3	13.7	0.33	1.8	0.99	0.16	0.079
	65.088	18.034	18.288	13.970	spec.	1.3	42 500	55 000	5 300	7 500	LM 29748	LM 29710	49	42.5	59	62	3.5	1.3	13.7	0.33	1.8	0.99	0.158	0.079
	65.088	19.812	18.288	15.748	2.3	1.3	42 500	55 000	5 300	7 500	LM 29749	LM 29711	46	42.5	58	62	2.3	1.3	15.5	0.33	1.8	0.99	0.16	0.094
	68.262	15.875	16.520	11.908	1.5	1.5	45 000	53 500	5 300	7 100	19150	19268	45	43	61	65	1.5	1.5	14.5	0.44	1.4	0.74	0.173	0.073
	69.012	19.050	19.050	15.083	2.0	2.3	49 000	61 000	5 300	7 100	13687	13621	46.5	43	61	65	2	2.3	15.8	0.40	1.5	0.82	0.193	0.104
	69.012	19.050	19.050	15.083	3.5	0.8	49 000	61 000	5 300	7 100	13685	13620	49.5	43	62	65	3.5	0.8	15.8	0.40	1.5	0.82	0.191	0.105
	72.238	20.638	20.638	15.875	3.5	1.3	48 500	59 500	5 300	7 100	16150	16284	49.5	43	63	67	3.5	1.3	16.0	0.40	1.5	0.82	0.212	0.146
	73.025	23.812	25.654	19.050	3.5	0.8	73 500	91 000	5 000	6 700	2788	2735 X	50	43.5	66	69	3.5	0.8	15.9	0.30	2.0	1.1	0.312	0.135
	76.200	23.812	25.654	19.050	3.5	3.3	73 500	91 000	5 000	6 700	2788	2720	50	43.5	66	70	3.5	3.3	15.9	0.30	2.0	1.1	0.312	0.187
	76.200	23.812	25.654	19.050	3.5	0.8	73 500	91 000	5 000	6 700	2788	2729	50	43.5	68	70	3.5	0.8	15.9	0.30	2.0	1.1	0.312	0.191
	79.375	29.370	29.771	23.812	3.5	3.3	88 000	106 000	4 800	6 700	3490	3420	52	45.5	67	74	3.5	3.3	20.0	0.37	1.6	0.90	0.404	0.259
	80.035	24.608	23.698	18.512	0.8	1.5	69 000	84 500	4 500	6 300	2780	27820	48	47	68	75	0.8	1.5	21.5	0.56	1.1	0.59	0.362	0.209
	82.550	29.370	28.575	23.020	0.8	3.3	87 000	117 000	4 500	6 000	HM 801346	HM 801310	51	49	68	78	0.8	3.3	24.2	0.55	1.1	0.60	0.483	0.282
	88.501	25.400	23.698	17.462	2.3	1.5	73 000	81 000	4 000	5 600	44150	44348	55	51	75	84	2.3	1.5	27.9	0.78	0.77	0.42	0.484	0.245
	88.501	26.988	29.083	22.225	3.5	1.5	96 500	109 000	4 500	6 000	418	414	51	44.5	77	80	3.5	1.5	17.1	0.26	2.3	1.3	0.50	0.329
	95.250	30.958	28.301	20.638	1.5	0.8	87 500	97 000	3 600	5 300	53150	53375	55	53	81	89	1.5	0.8	30.7	0.74	0.81	0.45	0.665	0.365
39.688	73.025	25.654	22.098	21.336	0.8	2.3	62 500	80 000	5 000	6 700	M 201047	M 201011	45.5	48	64	69	0.8	2.3	19.7	0.33	1.8	0.99	0.266	0.169
	76.200	23.812	25.654	19.050	3.5	3.3	73 500	91 000	5 000	6 700	2789	2720	52	45	66	70	3.5	3.3	15.9	0.30	2.0	1.1	0.292	0.187
	80.167	29.370	30.391	23.812	0.8	3.3	92 500	108 000	4 800	6 300	3386	3320	46.5	45.5	70	75	0.8	3.3	18.4	0.27	2.2	1.2	0.442	0.217
40.000	80.000	21.000	22.403	17.826	3.5	1.3	68 500	75 500	4 500	6 300	344	332	52	45.5	73	75	3.5	1.3	14.5	0.27	2.2	1.2	0.338	0.146
	80.000	21.000	22.403	17.826	0.8	1.3	68 500	75 500	4 500	6 300	344 A	332	46	45.5	73	75	0.8	1.3	14.5	0.27	2.2	1.2	0.339	0.146
	88.501	25.400	23.698	17.462	2.3	1.5	73 000	81 000	4 000	5 600	44157	44348	56	51	75	84	2.3	1.5	27.9	0.78	0.77	0.42	0.463	0.245
41.000	68.000	17.500	18.000	13.500	spec.	1.5	43 500	58 000	5 300	7 100	* LM 300849	** LM 300811	52	45	61	65	3.5	1.5	13.9	0.35	1.7	0.95	0.16	0.082
41.275	73.025	16.667	17.462	12.700	3.5	1.5	44 500	54 000	4 800	6 700	18590	18520	53	46	66	69	3.5	1.5	14.0	0.35	1.7	0.94	0.199	0.086
	73.431	19.558	19.812	14.732	3.5	0.8	54 500	67 000	4 800	6 700	LM 501349	LM 501310	53	46.5	67	70	3.5	0.8	16.3	0.40	1.5	0.83	0.226	0.108
	73.431	21.430	19.812	16.604	3.5	0.8	54 500	67 000	4 800	6 700	LM 501349	LM 501314	53	46.5	66	70	3.5	0.8	18.2	0.40	1.5	0.83	0.226	0.129

- Notes**
- * The maximum bore diameter is listed and its tolerance is negative (see Table 7.4.1 on Page A136).
 - ** The maximum outside diameter is listed and its tolerance is negative (see Table 7.4.2 on Pages A136 and A137).
 - ▲ Tolerances are listed in Tables 2, 3, and 4 on Pages C184 and C185.

■ SINGLE-ROW TAPERED ROLLER BEARINGS (INCH SERIES)

Bore Diameter 41.275 – 44.450 mm

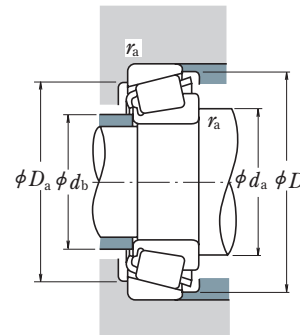
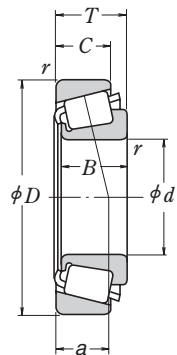

Dynamic Equivalent Load

$$P = XF_r + YF_a$$

$F_a/F_r \leq e$		$F_a/F_r > e$	
X	Y	X	Y
1	0	0.4	Y_1

Static Equivalent Load

$$P_0 = 0.5F_r + Y_0F_a$$

When $F_r > 0.5F_r + Y_0F_a$, use $P_0 = F_r$

The values of e , Y_1 , and Y_0 are given in the table below.

d	Boundary Dimensions (mm)				Ring: Inner r min. Outer r	Basic Load Ratings (N)		Limiting Speeds (min ⁻¹)		Bearing Designations		Abutment and Fillet Dimensions (mm)				Eff. Load Center (mm) a	Constant e	Axial Load Factors		Mass (kg)				
	D	T	B	C		C _r	C _{0r}	Grease	Oil	INNER RING	OUTER RING	d _a	d _b	D _a	D _b			Y ₁	Y ₀	Inner Ring	Outer Ring			
41.275	76.200	18.009	17.384	14.288	1.5	1.5	42 500	51 000	4 500	6 300	11162	11300	49	46.5	67	71	1.5	1.5	17.4	0.49	1.2	0.68	0.212	0.129
	76.200	22.225	23.020	17.462	3.5	0.8	66 000	82 000	4 800	6 700	24780	24720	53	47.5	68	72	3.5	0.8	17.0	0.39	1.5	0.84	0.279	0.15
	76.200	25.400	23.020	20.638	3.5	2.3	66 000	82 000	4 800	6 700	24780	24721	54	47	66	72	3.5	2.3	20.2	0.39	1.5	0.84	0.279	0.189
	79.375	23.812	25.400	19.050	3.5	0.8	77 000	98 500	4 800	6 300	26882	26822	54	47	71	74	3.5	0.8	16.4	0.32	1.9	1.0	0.349	0.186
	80.000	21.000	22.403	17.826	0.8	1.3	68 500	75 500	4 500	6 300	336	332	47	46	73	75	0.8	1.3	14.5	0.27	2.2	1.2	0.325	0.146
	80.000	21.000	22.403	17.826	3.5	1.3	68 500	75 500	4 500	6 300	342	332	53	46	73	75	3.5	1.3	14.5	0.27	2.2	1.2	0.325	0.146
	80.167	25.400	25.400	20.638	3.5	3.3	77 000	98 500	4 800	6 300	26882	26820	54	47	69	74	3.5	3.3	18.0	0.32	1.9	1.0	0.349	0.219
	82.550	26.543	25.654	20.193	3.5	3.3	78 500	102 000	4 300	6 000	M 802048	M 802011	57	51	70	79	3.5	3.3	22.9	0.55	1.1	0.60	0.406	0.23
	85.725	30.162	30.162	23.812	3.5	3.3	91 000	115 000	4 300	6 000	3877	3820	57	50	73	81	3.5	3.3	21.8	0.40	1.5	0.82	0.506	0.285
	87.312	30.162	30.886	23.812	0.8	3.3	96 000	120 000	4 300	6 000	3576	3525	49	48	75	81	0.8	3.3	19.5	0.31	2.0	1.1	0.532	0.304
	88.501	25.400	23.698	17.462	2.3	1.5	69 000	75 500	4 000	5 600	44162	44348	57	51	75	84	2.3	1.5	28.0	0.78	0.77	0.42	0.447	0.245
	88.900	30.162	29.370	23.020	3.5	3.3	96 500	129 000	4 000	5 600	HM 803146	HM 803110	60	53	74	85	3.5	3.3	25.6	0.55	1.1	0.60	0.579	0.322
	88.900	30.162	29.370	23.020	0.8	3.3	96 500	129 000	4 000	5 600	HM 803145	HM 803110	54	53	74	85	0.8	3.3	25.6	0.55	1.1	0.60	0.582	0.322
	90.488	39.688	40.386	33.338	3.5	3.3	139 000	180 000	4 300	5 600	4388	4335	57	51	77	85	3.5	3.3	24.6	0.28	2.1	1.2	0.789	0.459
	93.662	31.750	31.750	26.195	0.8	3.3	110 000	142 000	4 000	5 600	46162	46368	52	51	79	87	0.8	3.3	24.0	0.40	1.5	0.82	0.695	0.405
95.250	30.162	29.370	23.020	3.5	3.3	106 000	143 000	3 800	5 300	HM 804840	HM 804810	61	54	81	91	3.5	3.3	26.1	0.55	1.1	0.60	0.726	0.354	
98.425	30.958	28.301	20.638	1.5	0.8	87 500	97 000	3 600	5 300	53162	53387	57	53	82	91	1.5	0.8	30.7	0.74	0.81	0.45	0.618	0.442	
42.862	76.992	17.462	17.145	11.908	1.5	1.5	44 000	54 000	4 500	6 000	12168	12303	51	48.5	68	73	1.5	1.5	17.7	0.51	1.2	0.65	0.228	0.098
	82.550	19.842	19.837	15.080	2.3	1.5	58 500	69 000	4 500	6 300	22325	22325	52	48.5	73	76	2.3	1.5	17.6	0.43	1.4	0.77	0.283	0.176
	82.931	23.812	25.400	19.050	2.3	0.8	76 500	99 000	4 500	6 000	25578	25520	53	49.5	74	77	2.3	0.8	17.6	0.33	1.8	0.99	0.383	0.203
	82.931	26.988	25.400	22.225	2.3	2.3	76 500	99 000	4 500	6 000	25578	25523	53	49.5	72	77	2.3	2.3	20.8	0.33	1.8	0.99	0.383	0.248
42.875	76.200	25.400	25.400	20.638	3.5	1.5	77 000	98 500	4 800	6 300	26884	26823	55	48.5	69	73	3.5	1.5	18.0	0.32	1.9	1.0	0.337	0.136
	80.000	21.000	22.403	17.826	3.5	1.3	68 500	75 500	4 500	6 300	342	332	54	47.5	73	75	3.5	1.3	14.5	0.27	2.2	1.2	0.305	0.146
	82.931	26.988	25.400	22.225	3.5	2.3	76 500	99 000	4 500	6 000	25577	25523	55	49	72	77	3.5	2.3	20.8	0.33	1.8	0.99	0.381	0.248
	83.058	23.812	25.400	19.050	3.5	3.3	76 500	99 000	4 500	6 000	25577	25521	55	49	72	77	3.5	3.3	17.6	0.33	1.8	0.99	0.381	0.201
43.000	74.988	19.368	19.837	14.288	1.5	1.3	52 500	68 000	4 800	6 300	* 16986	16929	51	48.5	67	71	1.5	1.3	17.2	0.44	1.4	0.74	0.24	0.106
	44.450	80.962	19.050	17.462	14.288	0.3	1.5	45 000	57 000	4 300	6 000	13175	13318	50	50	72	76	0.3	1.5	20.1	0.53	1.1	0.63	0.252
82.931		23.812	25.400	19.050	3.5	0.8	76 500	99 000	4 500	6 000	25580	25520	57	50	74	77	3.5	0.8	17.6	0.33	1.8	0.99	0.359	0.203
83.058		23.812	25.400	19.050	3.5	3.3	76 500	99 000	4 500	6 000	25580	25521	56	51	72	78	3.5	3.3	17.6	0.33	1.8	0.99	0.359	0.201
87.312		30.162	30.886	23.812	3.5	3.3	96 000	120 000	4 300	6 000	3578	3525	57	51	75	81	3.5	3.3	19.5	0.31	2.0	1.1	0.477	0.304
88.900		30.162	29.370	23.020	3.5	3.3	96 500	129 000	4 000	5 600	HM 803149	HM 803110	62	53	74	85	3.5	3.3	25.6	0.55	1.1	0.60	0.528	0.322
93.264		30.162	30.302	23.812	3.5	3.2	103 000	136 000	3 800	5 300	3782	3720	58	52	82	88	3.5	3.2	22.4	0.34	1.8	0.97	0.678	0.292
93.662		31.750	31.750	25.400	0.8	3.3	120 000	147 000	4 000	5 600	49176	49368	54	53	82	87	0.8	3.3	21.6	0.36	1.7	0.92	0.648	0.371
93.662		31.750	31.750	25.400	3.5	3.3	120 000	147 000	4 000	5 600	49175	49368	59	53	82	87	3.5	3.3	21.6	0.36	1.7	0.92	0.645	0.371
93.662		31.750	31.750	26.195	3.5	3.3	110 000	142 000	4 000	5 600	46176	46368	60	54	79	87	3.5	3.3	24.0	0.40	1.5	0.82	0.635	0.405
95.250		27.783	29.901	22.225	3.5	2.3	106 000	126 000	4 300	5 600	438	432	57	51	83	87	3.5	2.3	18.6	0.28	2.1	1.2	0.555	0.384

Note * The maximum bore diameter is listed and its tolerance is negative (see Table 7.4.1 on Page A136).

Bore Diameter 44.450 – 47.625 mm

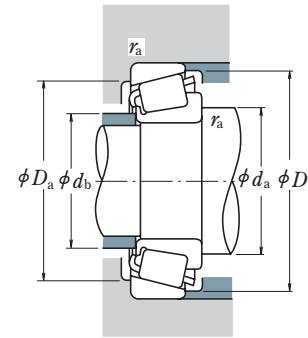
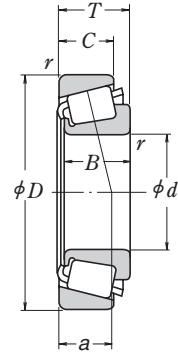

Dynamic Equivalent Load

$$P = XF_r + YF_a$$

$F_a/F_r \leq e$		$F_a/F_r > e$	
X	Y	X	Y
1	0	0.4	Y_1

Static Equivalent Load

$$P_0 = 0.5F_r + Y_0F_a$$

When $F_r > 0.5F_r + Y_0F_a$, use $P_0 = F_r$

The values of e , Y_1 , and Y_0 are given in the table below.

Boundary Dimensions (mm)					Ring:		Basic Load Ratings (N)		Limiting Speeds (min ⁻¹)		Bearing Designations		Abutment and Fillet Dimensions (mm)				Eff. Load Center (mm)	Constant	Axial Load Factors		Mass (kg)			
d	D	T	B	C	Inner r	Outer r min.	C _r	C _{0r}	Grease	Oil	INNER RING	OUTER RING	d _a	d _b	D _a	D _b	Inner r max.	Outer r max.	a	e	Y ₁	Y ₀	Inner	Outer
44.450	95.250	30.162	29.370	23.020	3.5	3.3	106 000	143 000	3 800	5 300	HM 804843	HM 804810	63	57	81	91	3.5	3.3	26.1	0.55	1.1	0.60	0.677	0.354
	95.250	30.958	28.301	20.638	3.5	0.8	87 500	97 000	3 600	5 300	53177	53375	63	53	81	89	3.5	0.8	30.7	0.74	0.81	0.45	0.572	0.365
	95.250	30.958	28.301	20.638	1.3	0.8	87 500	97 000	3 600	5 300	53176	53375	59	53	81	89	1.3	0.8	30.7	0.74	0.81	0.45	0.574	0.365
	95.250	30.958	28.301	20.638	2.0	0.8	87 500	97 000	3 600	5 300	53178	53375	60	53	81	89	2	0.8	30.7	0.74	0.81	0.45	0.574	0.365
	95.250	30.958	28.301	22.225	1.3	0.8	100 000	122 000	3 600	5 000	HM 903247	HM 903210	61	54	81	91	1.3	0.8	31.5	0.74	0.81	0.45	0.651	0.389
	95.250	30.958	28.575	22.225	3.5	0.8	100 000	122 000	3 600	5 000	HM 903249	HM 903210	65	54	81	91	3.5	0.8	31.5	0.74	0.81	0.45	0.635	0.389
	98.425	30.958	28.301	20.638	3.5	0.8	87 500	97 000	3 600	5 300	53177	53387	63	53	82	91	3.5	0.8	30.7	0.74	0.81	0.45	0.568	0.442
	103.188	43.658	44.475	36.512	1.3	3.3	178 000	238 000	3 800	5 000	5356	5335	58	56	89	97	1.3	3.3	27.0	0.30	2.0	1.1	1.23	0.637
	104.775	36.512	36.512	28.575	3.5	3.3	139 000	192 000	3 400	4 800	HM 807040	HM 807010	66	59	89	100	3.5	3.3	29.7	0.49	1.2	0.68	1.14	0.502
	107.950	27.783	29.317	22.225	3.5	0.8	116 000	149 000	3 400	4 800	460	453 A	60	54	97	100	3.5	0.8	20.7	0.34	1.8	0.98	0.93	0.42
	111.125	30.162	26.909	20.638	3.5	3.3	92 500	110 000	3 200	4 300	55175	55437	67	60	92	105	3.5	3.3	37.3	0.88	0.68	0.37	0.867	0.514
	114.300	44.450	44.450	34.925	3.5	3.3	172 000	205 000	3 600	4 800	65385	65320	65	59	97	107	3.5	3.3	32.2	0.43	1.4	0.77	1.39	0.894
44.983	82.931	23.812	25.400	19.050	1.5	0.8	76 500	99 000	4 500	6 000	25584	25520	53	51	74	77	1.5	0.8	17.6	0.33	1.8	0.99	0.354	0.203
	93.264	20.638	22.225	15.082	0.8	1.3	77 000	93 000	3 800	5 300	376	374	54	54	85	88	0.8	1.3	17.1	0.34	1.8	0.97	0.492	0.174
45.230	79.985	19.842	20.638	15.080	2.0	1.3	62 000	78 500	4 500	6 000	17887	17831	57	52	68	74	2	1.3	15.9	0.37	1.6	0.90	0.274	0.136
45.242	73.431	19.558	19.812	15.748	3.5	0.8	53 500	75 000	4 800	6 300	LM 102949	LM 102910	56	50	68	70	3.5	0.8	14.6	0.31	2.0	1.1	0.213	0.102
	77.788	19.842	19.842	15.080	3.5	0.8	56 000	71 000	4 500	6 300	LM 603049	LM 603011	57	50	71	74	3.5	0.8	17.2	0.43	1.4	0.77	0.249	0.119
	77.788	21.430	19.842	16.667	3.5	0.8	56 000	71 000	4 500	6 300	LM 603049	LM 603012	57	50	70	74	3.5	0.8	18.8	0.43	1.4	0.77	0.249	0.137
45.618	82.931	23.812	25.400	19.050	3.5	0.8	76 500	99 000	4 500	6 000	25590	25520	58	51	74	77	3.5	0.8	17.6	0.33	1.8	0.99	0.343	0.203
	82.931	26.988	25.400	22.225	3.5	2.3	76 500	99 000	4 500	6 000	25590	25523	58	51	72	77	3.5	2.3	20.8	0.33	1.8	0.99	0.343	0.248
46.000	75.000	18.000	18.000	14.000	2.3	1.5	51 000	71 500	4 500	6 300	* LM 503349	** LM 503310	55	51	67	71	2.3	1.5	15.9	0.40	1.5	0.82	0.209	0.096
46.038	79.375	17.462	17.462	13.495	2.8	1.5	46 000	57 000	4 500	6 000	18690	18620	56	51	71	74	2.8	1.5	15.5	0.37	1.6	0.88	0.211	0.126
	80.962	19.050	17.462	14.288	0.8	1.5	45 000	57 000	4 300	6 000	13181	13318	52	52	72	76	0.8	1.5	20.1	0.53	1.1	0.63	0.236	0.144
	85.000	20.638	21.692	17.462	2.3	1.3	71 500	81 500	4 300	6 000	359 S	354 A	55	51	77	80	2.3	1.3	15.4	0.31	2.0	1.1	0.343	0.162
	85.000	25.400	25.608	20.638	3.5	1.3	79 500	105 000	4 300	6 000	2984	2924	58	52	76	80	3.5	1.3	19.0	0.35	1.7	0.95	0.397	0.223
47.625	95.250	27.783	29.901	22.225	3.5	0.8	106 000	126 000	4 300	5 600	436	432 A	59	52	84	87	3.5	0.8	18.6	0.28	2.1	1.2	0.536	0.381
	88.900	20.638	22.225	16.513	3.5	1.3	73 000	85 000	4 000	5 600	369 A	362 A	60	53	81	84	3.5	1.3	16.6	0.32	1.9	1.0	0.381	0.166
	88.900	25.400	25.400	19.050	3.5	3.3	86 000	107 000	4 000	5 600	M 804049	M 804010	63	56	77	85	3.5	3.3	23.8	0.55	1.1	0.60	0.455	0.218
	95.250	30.162	29.370	23.020	3.5	3.3	106 000	143 000	3 800	5 300	HM 804846	HM 804810	66	57	81	91	3.5	3.3	26.1	0.55	1.1	0.60	0.626	0.354
	101.600	34.925	36.068	26.988	3.5	3.3	137 000	169 000	3 800	5 000	528	522	62	55	89	95	3.5	3.3	22.1	0.29	2.1	1.2	0.894	0.416
	111.125	30.162	26.909	20.638	3.5	3.3	92 500	110 000	3 200	4 300	55187	55437	69	62	92	105	3.5	3.3	37.3	0.88	0.68	0.37	0.817	0.514
	112.712	30.162	26.909	20.638	3.5	3.3	92 500	110 000	3 200	4 300	55187	55443	69	62	92	106	3.5	3.3	37.3	0.88	0.68	0.37	0.816	0.554
	117.475	33.338	31.750	23.812	3.5	3.3	137 000	156 000	3 200	4 300	66187	66462	66	62	100	111	3.5	3.3	32.1	0.63	0.96	0.53	1.19	0.552
	123.825	36.512	32.791	25.400	3.5	3.3	143 000	160 000	3 000	4 000	72187	72487	72	66	102	116	3.5	3.3	37.0	0.74	0.81	0.45	1.29	0.79

Notes * The maximum bore diameter is listed and its tolerance is negative (see Table 7.4.1 on Page A136).
 ** The maximum outside diameter is listed and its tolerance is negative (see Table 7.4.2 on Pages A136 and A137).

■ SINGLE-ROW TAPERED ROLLER BEARINGS (INCH SERIES)

Bore Diameter 48.412 – 52.388 mm

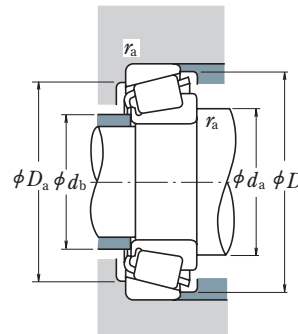
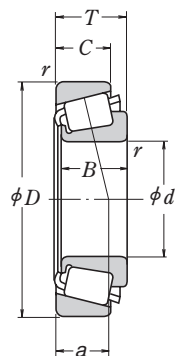

Dynamic Equivalent Load

$$P = XF_r + YF_a$$

$F_a/F_r \leq e$		$F_a/F_r > e$	
X	Y	X	Y
1	0	0.4	Y_1

Static Equivalent Load

$$P_0 = 0.5F_r + Y_0F_a$$

When $F_r > 0.5F_r + Y_0F_a$, use $P_0 = F_r$

The values of e , Y_1 , and Y_0 are given in the table below.

Boundary Dimensions (mm)					Ring:		Basic Load Ratings (N)		Limiting Speeds (min ⁻¹)		Bearing Designations		Abutment and Fillet Dimensions (mm)				Eff. Load Center (mm)	Constant	Axial Load Factors		Mass (kg)			
<i>d</i>	<i>D</i>	<i>T</i>	<i>B</i>	<i>C</i>	Inner	Outer	C_r	C_{0r}	Grease	Oil	INNER RING	OUTER RING	d_a	d_b	D_a	D_b	r_a	<i>a</i>	<i>e</i>	Y_1	Y_0	approx.		
					<i>r</i>	<i>r</i>																	Inner Ring	Outer Ring
					min.	max.																		
48.412	95.250	30.162	29.370	23.020	3.5	3.3	106 000	143 000	3 800	5 300	HM 804849	HM 804810	66	57	81	91	3.5	3.3	26.1	0.55	1.1	0.60	0.61	0.354
	95.250	30.162	29.370	23.020	2.3	3.3	106 000	143 000	3 800	5 300	HM 804848	HM 804810	63	57	81	91	2.3	3.3	26.1	0.55	1.1	0.60	0.614	0.354
49.212	104.775	36.512	36.512	28.575	3.5	0.8	139 000	192 000	3 400	4 800	HM 807044	HM 807011	69	63	91	100	3.5	0.8	29.7	0.49	1.2	0.68	1.03	0.508
	114.300	44.450	44.450	36.068	3.5	3.3	196 000	243 000	3 400	4 800	HH 506348	HH 506310	71	61	97	107	3.5	3.3	30.8	0.40	1.5	0.82	1.43	0.837
50.000	82.000	21.500	21.500	17.000	3.0	0.5	71 000	96 000	4 300	5 600	▲ JLM 104948	▲ JLM 104910	60	55	76	78	3	0.5	16.1	0.31	2.0	1.1	0.306	0.129
	82.550	21.590	22.225	16.510	0.5	1.3	71 000	96 000	4 300	5 600	* LM 104947 A	LM 104911	55	55	75	78	0.5	1.3	15.7	0.31	2.0	1.1	0.316	0.133
	88.900	20.638	22.225	16.513	2.3	1.3	73 000	85 000	4 000	5 600	366	362 A	59	55	81	84	2.3	1.3	16.6	0.32	1.9	1.0	0.351	0.166
	90.000	28.000	28.000	23.000	3.0	2.5	104 000	136 000	4 000	5 600	▲ JM 205149	▲ JM 205110	62	57	80	85	3	2.5	19.9	0.33	1.8	1.0	0.507	0.246
50.800	105.000	37.000	36.000	29.000	3.0	2.5	139 000	192 000	3 400	4 800	▲ JHM 807045	▲ JHM 807012	69	63	90	100	3	2.5	29.7	0.49	1.2	0.68	1.01	0.523
	80.962	18.258	18.258	14.288	1.5	1.5	53 000	81 000	4 300	5 600	L 305649	L 305610	58	56	73	77	1.5	1.5	15.7	0.36	1.7	0.93	0.239	0.119
52.388	82.550	23.622	22.225	18.542	3.5	0.8	71 000	96 000	4 300	5 600	LM 104949	LM 104911 A	62	55	75	78	3.5	0.8	17.8	0.31	2.0	1.1	0.303	0.156
	82.931	21.590	22.225	16.510	3.5	1.3	71 000	96 000	4 300	5 600	LM 104949	LM 104912	62	55	75	78	3.5	1.3	15.7	0.31	2.0	1.1	0.301	0.14
	85.000	17.462	17.462	13.495	3.5	1.5	48 500	63 000	4 300	5 600	18790	18720	62	56	77	80	3.5	1.5	16.7	0.41	1.5	0.81	0.239	0.136
	85.725	19.050	18.263	12.700	1.5	1.5	42 500	54 000	4 000	5 300	18200	18337	59	56	76	81	1.5	1.5	21.0	0.57	1.1	0.58	0.268	0.136
	88.900	20.638	22.225	16.513	3.5	1.3	73 000	85 000	4 000	5 600	368 A	362 A	62	56	81	84	3.5	1.3	16.6	0.32	1.9	1.0	0.338	0.166
	88.900	20.638	22.225	16.513	1.5	1.3	73 000	85 000	4 000	5 600	368	362 A	58	56	81	84	1.5	1.3	16.6	0.32	1.9	1.0	0.341	0.166
	92.075	24.608	25.400	19.845	3.5	0.8	84 500	117 000	4 000	5 300	28580	28521	63	57	83	87	3.5	0.8	20.0	0.38	1.6	0.87	0.46	0.247
	93.264	30.162	30.302	23.812	0.8	0.8	103 000	136 000	3 800	5 300	3775	3730	58	58	84	88	0.8	0.8	22.4	0.34	1.8	0.97	0.568	0.297
	93.264	30.162	30.302	23.812	3.5	0.8	103 000	136 000	3 800	5 300	3780	3730	64	58	84	88	3.5	0.8	22.4	0.34	1.8	0.97	0.564	0.297
	95.250	27.783	28.575	22.225	3.5	2.3	110 000	144 000	3 800	5 300	33889	33821	64	58	85	90	3.5	2.3	19.8	0.33	1.8	1.0	0.601	0.267
	101.600	31.750	31.750	25.400	3.5	3.3	118 000	150 000	3 600	5 000	49585	49520	66	59	88	96	3.5	3.3	23.4	0.40	1.5	0.82	0.744	0.389
	101.600	34.925	36.068	26.988	0.8	3.3	137 000	169 000	3 800	5 000	529	522	59	58	89	95	0.8	3.3	22.1	0.29	2.1	1.2	0.822	0.416
	101.600	34.925	36.068	26.988	3.5	3.3	137 000	169 000	3 800	5 000	529 X	522	65	58	89	95	3.5	3.3	22.1	0.29	2.1	1.2	0.819	0.416
	104.775	36.512	36.512	28.575	3.5	0.8	139 000	192 000	3 400	4 800	HM 807046	HM 807011	70	63	91	100	3.5	0.8	29.7	0.49	1.2	0.68	0.992	0.508
	104.775	36.512	36.512	28.575	3.5	3.3	139 000	192 000	3 400	4 800	HM 807046	HM 807010	70	63	89	100	3.5	3.3	29.7	0.49	1.2	0.68	0.993	0.502
108.966	34.925	36.512	26.988	3.5	3.3	145 000	181 000	3 600	4 800	59200	59429	68	61	93	101	3.5	3.3	25.4	0.40	1.5	0.82	0.943	0.594	
111.125	30.162	26.909	20.638	3.5	3.3	113 000	152 000	3 000	4 300	55200 C	55437	71	65	92	105	3.5	3.3	37.6	0.88	0.68	0.37	0.845	0.514	
111.125	30.162	26.909	20.638	3.5	3.3	92 500	110 000	3 200	4 300	55200	55437	71	64	92	105	3.5	3.3	37.3	0.88	0.68	0.37	0.767	0.514	
123.825	36.512	32.791	25.400	3.5	3.3	162 000	199 000	2 800	4 000	72200 C	72487	77	67	102	116	3.5	3.3	38.0	0.74	0.81	0.45	1.33	0.79	
123.825	36.512	32.791	25.400	3.5	3.3	143 000	160 000	3 000	4 000	72200	72487	74	66	102	116	3.5	3.3	37.0	0.74	0.81	0.45	1.22	0.79	
127.000	44.450	44.450	34.925	3.5	3.3	199 000	258 000	3 000	4 000	65200	65500	75	69	107	119	3.5	3.3	35.0	0.49	1.2	0.68	1.86	1.03	
127.000	50.800	52.388	41.275	3.5	3.3	236 000	300 000	3 200	4 300	6279	6220	71	65	108	117	3.5	3.3	30.7	0.30	2.0	1.1	2.08	1.22	
52.388	92.075	24.608	19.845	3.5	0.8	84 500	117 000	4 000	5 300	28584	28521	65	58	83	87	3.5	0.8	20.0	0.38	1.6	0.87	0.435	0.247	
	100.000	25.000	22.225	21.824	2.3	2.0	77 000	93 000	3 800	5 300	377	372	62	58	86	90	2.3	2	21.4	0.34	1.8	0.97	0.392	0.435
	111.125	30.162	26.909	20.638	3.5	3.3	92 500	110 000	3 200	4 300	55206	55437	72	64	92	105	3.5	3.3	37.3	0.88	0.68	0.37	0.737	0.514

Notes * The maximum bore diameter is listed and its tolerance is negative (see Table 7.4.1 on Page A136).
▲ Tolerances are listed in Tables 2, 3, and 4 on Pages C184 and C185.

■ SINGLE-ROW TAPERED ROLLER BEARINGS (INCH SERIES)

Bore Diameter 53.975 – 58.738 mm

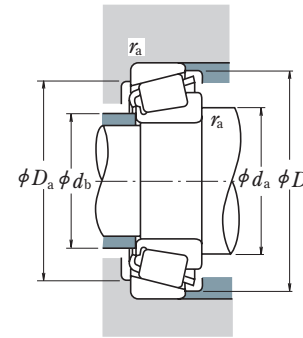
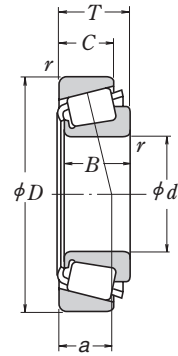

Dynamic Equivalent Load

$$P = XF_r + YF_a$$

$F_a/F_r \leq e$		$F_a/F_r > e$	
X	Y	X	Y
1	0	0.4	Y_1

Static Equivalent Load

$$P_0 = 0.5F_r + Y_0F_a$$

When $F_r > 0.5F_r + Y_0F_a$, use $P_0 = F_r$

The values of e , Y_1 , and Y_0 are given in the table below.

Boundary Dimensions (mm)					Ring:		Basic Load Ratings (N)		Limiting Speeds (min ⁻¹)		Bearing Designations		Abutment and Fillet Dimensions (mm)				Eff. Load Center (mm)	Constant	Axial Load Factors		Mass (kg)		
d	D	T	B	C	Inner	Outer	C_r	C_{0r}	Grease	Oil	INNER RING	OUTER RING	d_a	d_b	D_a	D_b	Ring: Inner Outer	a	e	Y_1	Y_0	approx. Inner Ring Outer Ring	
					r	r																	
					min.	max.																	
53.975	104.775	39.688	40.157	33.338	3.5	3.3	148 000	207 000	3 600	4 800	4595	4535	70	63	90	99	3.5	3.3	27.4	0.34	1.79	0.98	0.989 0.589
	107.950	36.512	36.957	28.575	3.5	3.3	144 000	182 000	3 600	4 800	539	532 X	68	61	94	100	3.5	3.3	24.3	0.30	2.0	1.1	0.88 0.57
	122.238	33.338	31.750	23.812	3.5	3.3	135 000	156 000	3 000	4 000	66584	66520	75	68	105	116	3.5	3.3	34.3	0.67	0.90	0.50	1.2 0.558
	123.825	36.512	32.791	25.400	3.5	3.3	143 000	160 000	3 000	4 000	72212	72487	77	66	102	116	3.5	3.3	37.0	0.74	0.81	0.45	1.16 0.79
	123.825	36.512	32.791	25.400	3.5	3.3	162 000	199 000	2 800	4 000	72212 C	72487	79	67	102	116	3.5	3.3	38.0	0.74	0.81	0.45	1.27 0.79
	123.825	38.100	36.678	30.162	3.5	3.3	161 000	221 000	3 000	4 000	557 S	552 A	71	65	109	116	3.5	3.3	28.8	0.35	1.7	0.95	1.49 0.764
	127.000	44.450	44.450	34.925	3.5	3.3	199 000	258 000	3 000	4 000	65212	65500	77	71	107	119	3.5	3.3	35.0	0.49	1.2	0.68	1.76 1.03
	127.000	50.800	52.388	41.275	3.5	3.3	236 000	300 000	3 200	4 300	6280	6220	74	67	108	117	3.5	3.3	30.7	0.30	2.0	1.1	1.97 1.22
	130.175	36.512	33.338	23.812	3.5	3.3	133 000	154 000	2 600	3 600	HM911242	HM911210	79	74	109	124	3.5	3.3	42.2	0.82	0.73	0.40	1.45 0.725
	55.000	90.000	23.000	23.000	18.500	1.5	0.5	79 000	111 000	3 800	5 300	▲ JLM506849	▲ JLM506810	63	61	82	86	1.5	0.5	19.7	0.40	1.5	0.82
95.000		29.000	29.000	23.500	1.5	2.5	111 000	152 000	3 800	5 000	▲ JM207049	▲ JM207010	64	62	85	91	1.5	2.5	21.3	0.33	1.8	0.99	0.59 0.26
96.838		21.000	21.946	15.875	2.3	0.8	80 500	100 000	3 600	5 000	385	382 A	65	61	89	92	2.3	0.8	17.6	0.35	1.7	0.93	0.455 0.179
110.000		39.000	39.000	32.000	3.0	2.5	177 000	225 000	3 400	4 500	▲ JH307749	▲ JH307710	71	64	97	104	3	2.5	27.2	0.35	1.7	0.95	1.13 0.567
55.562	115.000	41.021	41.275	31.496	3.0	3.0	172 000	214 000	3 200	4 500	622 X	614 X	70	64	101	108	3	3	26.6	0.31	1.9	1.1	1.3 0.597
	97.630	24.608	24.608	19.446	3.5	0.8	89 000	129 000	3 600	5 000	28680	28622	68	62	88	92	3.5	0.8	21.3	0.40	1.5	0.82	0.499 0.27
	122.238	43.658	43.764	36.512	1.3	3.3	198 000	292 000	3 000	4 000	5566	5535	70	68	106	116	1.3	3.3	29.9	0.36	1.7	0.92	1.76 0.815
	123.825	36.512	32.791	25.400	3.5	3.3	143 000	160 000	3 000	4 000	72218	72487	78	66	102	116	3.5	3.3	37.0	0.74	0.81	0.45	1.12 0.79
	123.825	36.512	32.791	25.400	3.5	3.3	162 000	199 000	2 800	4 000	72218 C	72487	80	67	102	116	3.5	3.3	38.0	0.74	0.81	0.45	1.23 0.79
57.150	96.838	21.000	21.946	15.875	3.5	0.8	80 500	100 000	3 600	5 000	387 A	382 A	69	62	89	92	3.5	0.8	17.6	0.35	1.7	0.93	0.42 0.179
	96.838	21.000	21.946	15.875	2.3	0.8	80 500	100 000	3 600	5 000	387	382 A	66	62	89	92	2.3	0.8	17.6	0.35	1.7	0.93	0.423 0.179
	96.838	25.400	21.946	20.275	3.5	2.3	80 500	100 000	3 600	5 000	387 A	382 S	69	62	87	91	3.5	2.3	22.0	0.35	1.7	0.93	0.42 0.249
	98.425	21.000	21.946	17.826	3.5	0.8	80 500	100 000	3 600	5 000	387 A	382	69	62	90	92	3.5	0.8	17.6	0.35	1.7	0.93	0.42 0.226
	104.775	30.162	29.317	24.605	3.5	3.3	116 000	149 000	3 400	4 800	469	453 X	70	63	92	98	3.5	3.3	23.1	0.34	1.8	0.98	0.692 0.376
	104.775	30.162	29.317	24.605	2.3	3.3	116 000	149 000	3 400	4 800	462	453 X	67	63	92	98	2.3	3.3	23.1	0.34	1.8	0.98	0.694 0.376
	104.775	30.162	30.958	23.812	0.8	3.3	130 000	170 000	3 400	4 800	45289	45220	65	65	93	99	0.8	3.3	21.9	0.33	1.8	0.99	0.752 0.347
	104.775	30.162	30.958	23.812	0.8	0.8	130 000	170 000	3 400	4 800	45289	45221	65	65	95	99	0.8	0.8	21.9	0.33	1.8	0.99	0.76 0.35
	122.238	33.338	31.750	23.812	3.5	3.3	135 000	156 000	3 000	4 000	66587	66520	77	71	105	116	3.5	3.3	34.3	0.67	0.90	0.50	1.14 0.558
	123.825	36.512	32.791	25.400	3.5	3.3	162 000	199 000	2 800	4 000	72225 C	72487	81	67	102	116	3.5	3.3	38.0	0.74	0.81	0.45	1.19 0.79
57.531 58.738	123.825	38.100	36.678	30.162	3.5	3.3	161 000	221 000	3 000	4 000	555 S	552 A	83	68	109	116	3.5	3.3	28.8	0.35	1.7	0.95	1.41 0.764
	140.030	36.512	33.236	23.520	3.5	2.3	152 000	183 000	2 600	3 600	78225	78551	83	77	117	132	3.5	2.3	44.2	0.87	0.69	0.38	1.67 0.926
	144.983	36.000	33.236	23.007	3.5	3.5	152 000	183 000	2 600	3 600	78225	78571	83	77	118	132	3.5	3.5	43.6	0.87	0.69	0.38	1.68 1.08
	149.225	53.975	54.229	44.450	3.5	3.3	287 000	410 000	2 600	3 400	6455	6420	81	75	129	140	3.5	3.3	39.0	0.36	1.7	0.91	3.49 1.63
	96.838	21.000	21.946	15.875	3.5	0.8	80 500	100 000	3 600	5 000	388 A	382 A	69	63	89	92	3.5	0.8	17.6	0.35	1.7	0.93	0.416 0.179
	112.712	33.338	30.048	26.988	3.5	3.3	120 000	173 000	3 200	4 300	3981	3926	73	67	98	106	3.5	3.3	28.7	0.40	1.5	0.82	0.899 0.541

Note ▲ Tolerances are listed in Tables 2, 3, and 4 on Pages C184 and C185.

■ SINGLE-ROW TAPERED ROLLER BEARINGS (INCH SERIES)

Bore Diameter 60.000 – 64.963 mm

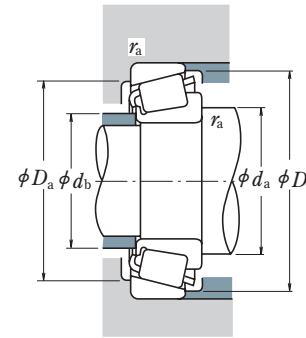
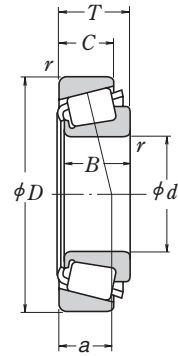

Dynamic Equivalent Load

$$P = XF_r + YF_a$$

$F_a/F_r \leq e$		$F_a/F_r > e$	
X	Y	X	Y
1	0	0.4	Y_1

Static Equivalent Load

$$P_0 = 0.5F_r + Y_0F_a$$

When $F_r > 0.5F_r + Y_0F_a$, use $P_0 = F_r$

The values of e , Y_1 , and Y_0 are given in the table below.

d	Boundary Dimensions (mm)				Ring: Inner r min.	Outer r	Basic Load Ratings (N)		Limiting Speeds (min ⁻¹)		Bearing Designations		Abutment and Fillet Dimensions (mm)					Eff. Load Center (mm) a	Constant e	Axial Load Factors		Mass (kg)		
	D	T	B	C			C _r	C _{0r}	Grease	Oil	INNER RING	OUTER RING	d _a	d _b	D _a	D _b	Cone r _a max.			Cup r _a max.	Y ₁	Y ₀	approx. Inner Ring	Outer Ring
60.000	95.000	24.000	24.000	19.000	5.0	2.5	86 500	125 000	3 600	5 000	▲ JLM 508748	▲ JLM 508710	75	66	85	91	5	2.5	21.6	0.40	1.5	0.82	0.43	0.20
	104.775	21.433	22.000	15.875	2.3	2.0	83 500	107 000	3 400	4 500	* 39236	39412	71	67	96	100	2.3	2	20.0	0.39	1.5	0.85	0.559	0.186
	110.000	22.000	21.996	18.824	0.8	1.3	85 500	113 000	3 200	4 300	397	394 A	69	68	101	104	0.8	1.3	20.9	0.40	1.5	0.82	0.642	0.263
	122.238	33.338	31.750	23.812	3.5	3.3	135 000	156 000	3 000	4 000	66585	66520	79	73	105	116	3.5	3.3	34.3	0.67	0.90	0.50	1.07	0.558
60.325	100.000	25.400	25.400	19.845	3.5	3.3	91 000	135 000	3 400	4 800	28985	28921	73	67	89	96	3.5	3.3	22.9	0.43	1.4	0.78	0.538	0.232
	101.600	25.400	25.400	19.845	3.5	3.3	91 000	135 000	3 400	4 800	28985	28920	73	67	90	97	3.5	3.3	22.9	0.43	1.4	0.78	0.538	0.272
	122.238	38.100	36.678	30.162	2.3	3.3	161 000	221 000	3 000	4 000	558	553 X	73	69	108	115	2.3	3.3	28.8	0.35	1.7	0.95	1.33	0.692
	122.238	38.100	38.354	29.718	8.0	1.5	188 000	245 000	3 000	4 000	HM 212044	HM 212010	85	70	110	116	8	1.5	27.0	0.34	1.8	0.98	1.43	0.604
61.912	122.238	43.658	43.764	36.512	0.8	3.3	198 000	292 000	3 000	4 000	5582	5535	73	72	106	116	0.8	3.3	29.9	0.36	1.7	0.92	1.61	0.815
	127.000	44.450	44.450	34.925	3.5	3.3	199 000	258 000	3 000	4 000	65237	65500	82	71	107	119	3.5	3.3	35.0	0.49	1.2	0.68	1.56	1.03
	130.175	41.275	41.275	31.750	3.5	3.3	195 000	263 000	2 800	3 800	637	633	78	72	116	124	3.5	3.3	29.9	0.36	1.7	0.91	1.87	0.712
	135.755	53.975	56.007	44.450	3.5	3.3	264 000	355 000	2 800	3 800	6376	6320	81	74	117	126	3.5	3.3	35.0	0.32	1.8	1.0	2.45	1.39
63.500	136.525	46.038	46.038	36.512	3.5	3.3	233 000	370 000	2 600	3 400	H 715334	H 715311	84	78	119	132	3.5	3.3	37.1	0.47	1.3	0.70	2.51	0.961
	146.050	41.275	39.688	25.400	3.5	3.3	193 000	225 000	2 400	3 400	H 913842	H 913810	90	82	124	138	3.5	3.3	44.4	0.78	0.77	0.42	2.2	0.898
	152.400	47.625	46.038	31.750	3.5	3.3	237 000	267 000	2 400	3 400	9180	9121	90	81	130	145	3.5	3.3	44.3	0.66	0.92	0.50	2.77	1.21
	94.458	19.050	19.050	15.083	1.5	1.5	59 000	100 000	3 600	4 800	L 610549	L 610510	71	69	86	91	1.5	1.5	19.6	0.42	1.4	0.78	0.306	0.154
64.963	104.775	21.433	22.000	15.875	2.0	2.0	83 500	107 000	3 400	4 500	39250	39412	73	69	96	100	2	2	20.0	0.39	1.5	0.85	0.501	0.186
	107.950	25.400	25.400	19.050	1.5	3.3	90 000	138 000	3 200	4 300	29586	29520	73	71	96	103	1.5	3.2	24.0	0.46	1.3	0.72	0.661	0.281
	110.000	22.000	21.996	18.824	3.5	1.3	85 500	113 000	3 200	4 300	395	394 A	77	70	101	104	3.5	1.3	20.9	0.40	1.5	0.82	0.58	0.263
	110.000	22.000	21.996	18.824	1.5	1.3	85 500	113 000	3 200	4 300	390 A	394 A	73	70	101	104	1.5	1.3	20.9	0.40	1.5	0.82	0.583	0.263
	112.712	30.162	30.048	23.812	3.5	3.2	120 000	173 000	3 200	4 300	3982	3920	77	71	99	106	3.5	3.2	25.5	0.40	1.5	0.82	0.789	0.454
	112.712	30.162	30.162	23.812	3.5	3.3	142 000	202 000	3 200	4 300	39585	39520	77	71	101	107	3.5	3.3	23.5	0.34	1.8	0.97	0.899	0.359
	112.712	33.338	30.048	26.988	3.5	3.3	120 000	173 000	3 200	4 300	3982	3926	78	71	98	106	3.5	3.3	28.7	0.40	1.5	0.82	0.789	0.541
	122.238	38.100	38.354	29.718	7.0	3.3	188 000	245 000	3 000	4 000	HM 212047	HM 212011	87	73	108	116	7	3.3	26.9	0.34	1.8	0.98	1.34	0.598
	122.238	38.100	38.354	29.718	7.0	1.5	188 000	245 000	3 000	4 000	HM 212047	HM 212010	87	73	110	116	7	1.5	26.9	0.34	1.8	0.98	1.34	0.604
	122.238	38.100	38.354	29.718	3.5	1.5	188 000	245 000	3 000	4 000	HM 212046	HM 212010	80	73	110	116	3.5	1.5	26.9	0.34	1.8	0.98	1.35	0.604
	122.238	43.658	43.764	36.512	3.5	3.3	198 000	292 000	3 000	4 000	5584	5535	81	75	106	116	3.5	3.3	29.9	0.36	1.7	0.92	1.5	0.815
	123.825	38.100	36.678	30.162	3.5	3.3	161 000	221 000	3 000	4 000	559	522 A	78	73	109	116	3.5	3.3	28.8	0.35	1.7	0.95	1.23	0.764
	127.000	36.512	36.170	28.575	3.5	3.3	166 000	234 000	2 800	3 800	565	563	80	73	112	120	3.5	3.3	28.3	0.36	1.6	0.91	1.46	0.655
	130.175	41.275	41.275	31.750	3.5	3.3	195 000	263 000	2 800	3 800	639	633	81	74	116	124	3.5	3.3	29.9	0.36	1.7	0.91	1.77	0.712
	136.525	36.512	33.236	23.520	2.3	3.3	152 000	183 000	2 600	3 600	78250	78537	85	79	115	130	2.3	3.3	44.2	0.87	0.69	0.38	1.51	0.782
	136.525	41.275	41.275	31.750	3.5	3.3	195 000	263 000	2 800	3 800	639	632	79	76	119	125	3.5	3.3	29.9	0.36	1.7	0.91	1.77	1.04
140.030	36.512	33.236	23.520	2.3	2.3	152 000	183 000	2 600	3 600	78250	78551	85	79	117	132	2.3	2.3	44.2	0.87	0.69	0.38	1.51	0.926	
127.000	36.512	36.170	28.575	3.5	3.3	166 000	234 000	2 800	3 800	569	563	81	74	112	120	3.5	3.3	28.3	0.36	1.6	0.91	1.41	0.655	

Notes * The maximum bore diameter is listed and its tolerance is negative (see Table 7.4.1 on Page A136).
▲ Tolerances are listed in Tables 2, 3, and 4 on Pages C184 and C185.

■ SINGLE-ROW TAPERED ROLLER BEARINGS (INCH SERIES)

Bore Diameter 65.000 – 69.850 mm

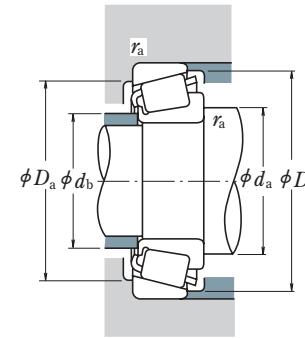
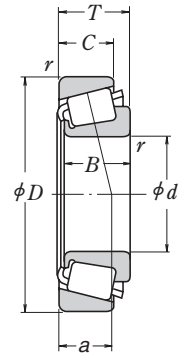

Dynamic Equivalent Load

$$P = XF_r + YF_a$$

$F_a/F_r \leq e$		$F_a/F_r > e$	
X	Y	X	Y
1	0	0.4	Y_1

Static Equivalent Load

$$P_0 = 0.5F_r + Y_0F_a$$

When $F_r > 0.5F_r + Y_0F_a$, use $P_0 = F_r$

The values of e , Y_1 , and Y_0 are given in the table below.

Boundary Dimensions (mm)					Ring:		Basic Load Ratings (N)		Limiting Speeds (min ⁻¹)		Bearing Designations		Abutment and Fillet Dimensions (mm)				Eff. Load Center (mm)	Constant	Axial Load Factors		Mass (kg)			
d	D	T	B	C	Inner	Outer	C _r	C _{0r}	Grease	Oil	INNER RING	OUTER RING	d _a	d _b	D _a	D _b	a	e	Y ₁	Y ₀	Inner Ring	Outer Ring		
					r	r min.							d _a	d _b	D _a	D _b	r _a max.						approx.	
65.000	105.000	24.000	23.000	18.500	3.0	1.0	93 000	126 000	3 400	4 500	▲ JLM 710949	▲ JLM 710910	77	71	96	101	3	1	23.7	0.45	1.3	0.73	0.526	0.237
	110.000	28.000	28.000	22.500	3.0	2.5	120 000	173 000	3 200	4 300	▲ JM 511946	▲ JM 511910	78	72	99	105	3	2.5	24.5	0.40	1.5	0.82	0.72	0.342
	120.000	29.002	29.007	23.444	2.3	3.3	123 000	169 000	3 000	4 000	478	472 A	77	73	106	114	2.3	3.3	24.3	0.38	1.6	0.86	0.942	0.466
	120.000	39.000	38.500	32.000	3.0	2.5	185 000	249 000	3 000	4 000	▲ JH 211749	▲ JH 211710	80	74	107	114	3	2.5	27.9	0.34	1.8	0.98	1.25	0.625
65.088	135.755	53.975	56.007	44.450	3.5	3.3	264 000	355 000	2 800	3 800	6379	6320	84	77	117	126	3.5	3.3	35.0	0.32	1.8	1.0	2.25	1.39
	136.525	46.038	46.038	36.512	3.5	3.3	233 000	370 000	2 600	3 400	H 715340	H 715311	88	82	118	132	3.5	3.3	37.1	0.47	1.3	0.70	2.4	0.961
66.675	110.000	22.000	21.996	18.824	0.8	1.3	85 500	113 000	3 200	4 300	395 A	394 A	73	73	101	104	0.8	1.3	20.9	0.40	1.5	0.82	0.528	0.263
	110.000	22.000	21.996	18.824	3.5	1.3	85 500	113 000	3 200	4 300	395 S	394 A	79	73	101	104	3.5	1.3	20.9	0.40	1.5	0.82	0.524	0.263
	112.712	30.162	30.048	23.812	3.5	3.2	120 000	173 000	3 200	4 300	3984	3920	80	74	99	106	3.5	3.2	25.5	0.40	1.5	0.82	0.712	0.454
	112.712	30.162	30.048	23.812	5.5	3.2	120 000	173 000	3 200	4 300	3994	3920	84	74	99	106	5.5	3.2	25.5	0.40	1.5	0.82	0.706	0.454
	112.712	30.162	30.162	23.812	3.5	0.8	142 000	202 000	3 200	4 300	39590	39521	80	74	103	107	3.5	0.8	23.5	0.34	1.8	0.97	0.822	0.365
	112.712	30.162	30.162	23.812	3.5	3.3	142 000	202 000	3 200	4 300	39590	39520	80	74	101	107	3.5	3.3	23.5	0.34	1.8	0.97	0.822	0.359
	117.475	30.162	30.162	23.812	3.5	3.3	119 000	179 000	3 000	4 000	33262	33462	81	75	104	112	3.5	3.3	26.8	0.44	1.4	0.76	0.911	0.442
	122.238	38.100	36.678	30.162	3.5	3.3	161 000	221 000	3 000	4 000	560	553 X	81	75	108	115	3.5	3.3	28.8	0.35	1.7	0.95	1.14	0.692
	122.238	38.100	38.354	29.718	3.5	1.5	188 000	245 000	3 000	4 000	HM 212049	HM 212010	82	75	110	116	3.5	1.5	26.9	0.34	1.8	0.98	1.25	0.604
	122.238	38.100	38.354	29.718	3.5	3.3	188 000	245 000	3 000	4 000	HM 212049	HM 212011	81	74	108	116	3.5	3.3	26.9	0.34	1.8	0.98	1.25	0.598
123.825	38.100	36.678	30.162	3.5	3.3	161 000	221 000	3 000	4 000	560	552 A	81	75	109	116	3.5	3.3	28.8	0.35	1.7	0.95	1.14	0.764	
136.525	46.038	46.038	36.512	3.5	3.3	233 000	370 000	2 600	3 400	H 715341	H 715311	89	83	118	132	3.5	3.3	37.1	0.47	1.3	0.70	2.34	0.961	
68.262	110.000	22.000	21.996	18.824	2.3	1.3	85 500	113 000	3 200	4 300	399 A	394 A	78	74	101	104	2.3	1.3	20.9	0.40	1.5	0.82	0.497	0.263
	120.000	29.795	29.007	24.237	3.5	2.0	123 000	169 000	3 000	4 000	480	472	83	76	106	113	3.5	2	25.1	0.38	1.6	0.86	0.862	0.493
	122.238	38.100	36.678	30.162	3.5	3.3	161 000	221 000	3 000	4 000	560 S	553 X	83	76	108	115	3.5	3.3	28.8	0.35	1.7	0.95	1.09	0.692
	127.000	36.512	36.170	28.575	3.5	3.3	166 000	234 000	2 800	3 800	570	563	83	77	112	120	3.5	3.3	28.3	0.36	1.6	0.91	1.32	0.655
	136.525	41.275	41.275	31.750	3.5	3.3	229 000	297 000	2 600	3 600	H 414245	H 414210	86	82	121	129	3.5	3.3	30.6	0.36	1.7	0.92	1.95	0.796
	136.525	46.038	46.038	36.512	3.5	3.3	233 000	370 000	2 600	3 400	H 715343	H 715311	90	84	118	132	3.5	3.3	37.1	0.47	1.3	0.70	2.28	0.961
	152.400	47.625	46.038	31.750	3.5	3.3	237 000	267 000	2 400	3 400	9185	9121	94	81	130	145	3.5	3.3	44.3	0.66	0.92	0.50	2.53	1.21
	152.400	47.625	46.038	31.750	3.5	3.3	237 000	267 000	2 400	3 400	9185	9121	94	81	130	145	3.5	3.3	44.3	0.66	0.92	0.50	2.53	1.21
69.850	112.712	22.225	21.996	15.875	1.5	0.8	85 000	113 000	3 000	4 000	LM 613449	LM 613410	78	76	104	107	1.5	0.8	22.1	0.42	1.4	0.79	0.562	0.238
	112.712	25.400	25.400	19.050	1.5	3.3	96 000	152 000	2 800	4 000	29675	29620	80	77	101	109	1.5	3.3	26.3	0.49	1.2	0.68	0.695	0.273
	117.475	30.162	30.162	23.812	3.5	3.3	119 000	179 000	3 000	4 000	33275	33462	84	77	104	112	3.5	3.3	26.8	0.44	1.4	0.76	0.83	0.442
	120.000	32.545	32.545	26.195	3.5	3.3	152 000	225 000	3 000	4 000	47487	47420	84	78	107	114	3.5	3.3	26.0	0.36	1.7	0.92	1.02	0.477
	120.650	25.400	25.400	19.050	1.5	3.3	96 000	152 000	2 800	4 000	29675	29630	79	78	105	113	1.5	3.3	26.3	0.49	1.2	0.68	0.695	0.489
	127.000	36.512	36.170	28.575	3.5	0.8	166 000	234 000	2 800	3 800	566	563 X	85	78	114	120	3.5	0.8	28.3	0.36	1.6	0.91	1.27	0.658
	130.175	41.275	41.275	31.750	3.5	3.3	195 000	263 000	2 800	3 800	643	633	86	80	116	124	3.5	3.3	29.9	0.36	1.7	0.91	1.56	0.712
	146.050	41.275	39.688	25.400	3.5	3.3	193 000	225 000	2 400	3 400	H 913849	H 913810	95	82	124	138	3.5	3.3	44.4	0.78	0.77	0.42	1.95	0.898
	146.050	41.275	41.275	31.750	3.5	3.3	207 000	296 000	2 400	3 200	655	653	88	82	131	139	3.5	3.3	33.2	0.41	1.5	0.81	2.35	0.891
	149.225	53.975	54.229	44.450	5.0	3.3	271 000	385 000	2 600	3 400	6454	6420	94	85	129	140	5	3.3	39.0	0.36	1.7	0.91	2.95	1.63
	150.089	44.450	46.672	36.512	3.5	3.3	265 000	370 000	2 400	3 200	745 A	742	88	82	134	142	3.5	3.3	32.5	0.33	1.8	1.0	2.82	1.07

Note ▲ Tolerances are listed in Tables 2, 3, and 4 on Pages C184 and C185.

SINGLE-ROW TAPERED ROLLER BEARINGS (INCH SERIES)

Bore Diameter 70.000 – 76.200 mm

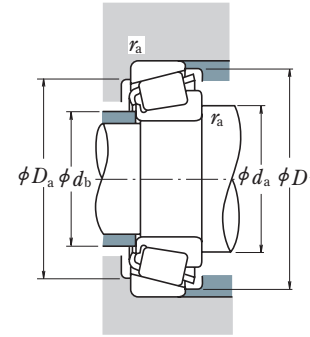
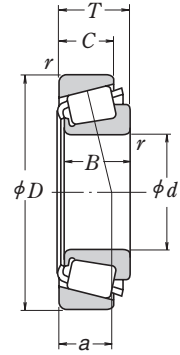

Dynamic Equivalent Load

$$P = XF_r + YF_a$$

$F_a/F_r \leq e$		$F_a/F_r > e$	
X	Y	X	Y
1	0	0.4	Y_1

Static Equivalent Load

$$P_0 = 0.5F_r + Y_0F_a$$

When $F_r > 0.5F_r + Y_0F_a$, use $P_0 = F_r$

The values of e , Y_1 , and Y_0 are given in the table below.

d	Boundary Dimensions (mm)					Ring: Inner r Outer min.	Basic Load Ratings (N)		Limiting Speeds (min ⁻¹)		Bearing Designations		Abutment and Fillet Dimensions (mm)					Eff. Load Center (mm) a	Constant e	Axial Load Factors		Mass (kg)		
	D	T	B	C	C _r		C _{0r}	Grease	Oil	INNER RING	OUTER RING	d _a	d _b	D _a	D _b	r _a max.	Y ₁			Y ₀	Inner Ring	Outer Ring		
																								approx.
70.000	110.000	26.000	25.000	20.500	1.0	2.5	98 500	152 000	3 000	4 000	▲ JLM 813049	▲ JLM 813010	78	77	98	105	1	2.5	26.2	0.49	1.2	0.68	0.604	0.304
	115.000	29.000	29.000	23.000	3.0	2.5	126 000	177 000	3 000	4 000	▲ JM 612949	▲ JM 612910	83	77	103	110	3	2.5	26.4	0.43	1.4	0.77	0.800	0.362
	120.000	29.795	29.007	24.237	2.0	2.0	123 000	169 000	3 000	4 000	484	472	80	78	106	113	2	2	25.1	0.38	1.6	0.86	0.822	0.493
71.438	117.475	30.162	30.162	23.812	3.5	3.3	119 000	179 000	3 000	4 000	33281	33462	85	79	104	112	3.5	3.3	26.8	0.44	1.4	0.76	0.789	0.442
	120.000	32.545	32.545	26.195	3.5	3.3	152 000	225 000	3 000	4 000	47490	47420	86	79	107	114	3.5	3.3	26.0	0.36	1.7	0.92	0.983	0.477
	127.000	36.512	36.170	28.575	6.4	3.3	166 000	234 000	2 800	3 800	567 S	563	92	80	112	120	6.4	3.3	28.3	0.36	1.6	0.91	1.21	0.655
	127.000	36.512	36.170	28.575	3.5	3.3	166 000	234 000	2 800	3 800	567 A	563	86	80	112	120	3.5	3.3	28.3	0.36	1.6	0.91	1.23	0.655
	130.175	41.275	41.275	31.750	6.4	3.3	195 000	263 000	2 800	3 800	645	633	93	81	116	124	6.4	3.3	29.9	0.36	1.7	0.91	1.49	0.712
	136.525	41.275	41.275	31.750	3.5	3.3	195 000	263 000	2 800	3 800	644	632	87	81	118	125	3.5	3.3	29.9	0.36	1.7	0.91	1.5	1.04
	136.525	41.275	41.275	31.750	3.5	3.3	229 000	297 000	2 600	3 600	H 414249	H 414210	89	83	121	129	3.5	3.3	30.6	0.36	1.7	0.92	1.83	0.796
73.025	136.525	46.038	46.038	36.512	3.5	3.3	233 000	370 000	2 600	3 400	H 715345	H 715311	92	84	119	132	3.5	3.3	37.1	0.47	1.3	0.70	2.15	0.961
	112.712	25.400	25.400	19.050	3.5	3.3	96 000	152 000	2 800	4 000	29685	29620	86	80	101	109	3.5	3.3	26.3	0.49	1.2	0.68	0.62	0.273
	117.475	30.162	30.162	23.812	3.5	3.3	119 000	179 000	3 000	4 000	33287	33462	87	80	104	112	3.5	3.3	26.8	0.44	1.4	0.76	0.746	0.442
	127.000	36.512	36.170	28.575	3.5	3.3	166 000	234 000	2 800	3 800	567	563	88	81	112	120	3.5	3.3	28.3	0.36	1.6	0.91	1.17	0.655
	146.050	41.275	41.275	31.750	3.5	3.3	207 000	296 000	2 400	3 200	657	653	91	85	131	139	3.5	3.3	33.2	0.41	1.5	0.81	2.24	0.891
73.817	149.225	53.975	54.229	44.450	3.5	3.3	287 000	410 000	2 600	3 400	6460	6420	93	87	129	140	3.5	3.3	39.0	0.36	1.7	0.91	2.8	1.63
	127.000	36.512	36.170	28.575	0.8	3.3	166 000	234 000	2 800	3 800	568	563	83	82	112	120	0.8	3.3	28.3	0.36	1.6	0.91	1.15	0.655
74.612	150.000	41.275	41.275	31.750	3.5	3.0	207 000	296 000	2 400	3 200	658	653 X	92	86	133	141	3.5	3	33.2	0.41	1.5	0.81	2.37	0.932
	115.000	25.000	25.000	19.000	3.0	2.5	101 000	150 000	3 000	4 000	▲ JLM 714149	▲ JLM 714110	87	81	104	110	3	2.5	25.3	0.46	1.3	0.72	0.638	0.272
75.000	120.000	31.000	29.500	25.000	3.0	2.5	129 000	198 000	2 800	3 800	▲ JM 714249	▲ JM 714210	88	83	108	115	3	2.5	28.8	0.44	1.4	0.74	0.863	0.436
	145.000	51.000	51.000	42.000	3.0	2.5	283 000	410 000	2 600	3 400	▲ JH 415647	▲ JH 415610	94	89	129	139	3	2.5	36.7	0.36	1.7	0.91	2.64	1.19
	121.442	24.608	23.012	17.462	2.0	2.0	89 000	124 000	2 800	3 800	34300	34478	86	84	111	116	2	2	26.3	0.45	1.3	0.73	0.65	0.316
76.200	127.000	30.162	31.000	22.225	3.5	3.3	134 000	195 000	2 800	3 800	42687	42620	90	84	114	121	3.5	3.3	27.3	0.42	1.4	0.79	1.03	0.438
	127.000	30.162	31.001	22.225	6.4	3.3	134 000	195 000	2 800	3 800	42688	42620	94	84	114	121	6.4	3.3	27.3	0.42	1.4	0.79	1.01	0.438
	133.350	33.338	33.338	26.195	0.8	3.3	154 000	237 000	2 600	3 600	47680	47620	86	85	119	128	0.8	3.3	29.0	0.40	1.5	0.82	1.39	0.577
	135.733	44.450	46.101	34.925	3.5	3.3	216 000	340 000	2 600	3 600	5760	5735	94	88	119	130	3.5	3.3	32.9	0.41	1.5	0.81	1.86	0.887
	136.525	30.162	29.769	22.225	3.5	3.3	130 000	192 000	2 600	3 400	495 A	493	92	86	122	130	3.5	3.3	28.7	0.44	1.4	0.74	1.27	0.55
	136.525	30.162	29.769	22.225	6.4	3.3	130 000	192 000	2 600	3 400	495 AX	493	98	86	122	130	6.4	3.3	28.7	0.44	1.4	0.74	1.26	0.55
	139.992	36.512	36.098	28.575	3.5	3.3	175 000	260 000	2 600	3 400	575	572	92	86	125	133	3.5	3.3	31.1	0.40	1.5	0.82	1.61	0.788
	149.225	53.975	54.229	44.450	3.5	3.3	271 000	385 000	2 600	3 400	6461	6420	96	89	129	140	3.5	3.3	39.0	0.36	1.7	0.91	2.45	1.67
	152.400	39.688	36.322	30.162	3.5	3.2	183 000	285 000	2 200	3 200	590 A	592 A	95	89	135	145	3.5	3.2	37.1	0.44	1.4	0.75	2.2	1.06
	152.400	41.275	41.275	31.750	3.5	3.3	207 000	296 000	2 400	3 200	659	652	93	87	134	141	3.5	3.3	33.2	0.41	1.5	0.81	2.11	1.26
	161.925	49.212	46.038	31.750	3.5	3.3	248 000	290 000	2 200	3 000	9285	9220	103	90	138	153	3.5	3.3	49.8	0.71	0.85	0.47	2.82	1.4
	161.925	53.975	55.100	42.862	3.5	3.3	325 000	480 000	2 200	3 000	6576	6535	99	92	141	154	3.5	3.3	40.7	0.40	1.5	0.82	3.74	1.67
	161.925	53.975	55.100	42.862	6.4	3.3	325 000	480 000	2 200	3 000	6575	6535	104	92	141	154	6.4	3.3	40.7	0.40	1.5	0.82	3.73	1.67
	161.925	53.975	55.100	42.862	6.4	0.8	325 000	480 000	2 200	3 000	6575	6536	104	92	144	154	6.4	0.8	40.7	0.40	1.5	0.82	3.73	1.68

Note ▲ Tolerances are listed in Tables 2, 3, and 4 on Pages C184 and C185.

■ SINGLE-ROW TAPERED ROLLER BEARINGS (INCH SERIES)

Bore Diameter 76.200 – 83.345 mm

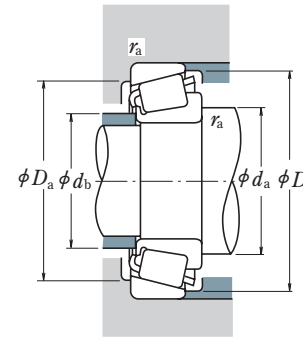
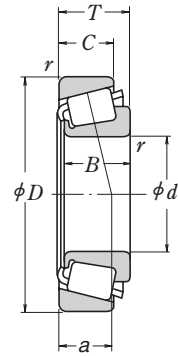

Dynamic Equivalent Load

$$P = XF_r + YF_a$$

$F_a/F_r \leq e$		$F_a/F_r > e$	
X	Y	X	Y
1	0	0.4	Y_1

Static Equivalent Load

$$P_0 = 0.5F_r + Y_0F_a$$

When $F_r > 0.5F_r + Y_0F_a$, use $P_0 = F_r$

The values of e , Y_1 , and Y_0 are given in the table below.

Boundary Dimensions (mm)					Ring:		Basic Load Ratings (N)		Limiting Speeds (min^{-1})		Bearing Designations		Abutment and Fillet Dimensions (mm)				Eff. Load Center (mm)	Constant	Axial Load Factors		Mass (kg)						
d	D	T	B	C	Inner	Outer	C_r	C_{0r}	Grease	Oil	INNER RING	OUTER RING	d_a	d_b	D_a	D_b	Inner	Outer	r_a	a	e	Y_1	Y_0	approx.	Inner	Outer	
					r	r											max.										
76.200	168.275	53.975	56.363	41.275	6.4	3.3	345 000	470 000	2 200	3 000	843	832	101	89	149	155	6.4	3.3	35.2	0.30	2.0	1.1	4.11	1.74			
	168.275	53.975	56.363	41.275	0.8	3.3	345 000	470 000	2 200	3 000	837	832	90	89	149	155	0.8	3.3	35.2	0.30	2.0	1.1	4.13	1.74			
	171.450	49.212	46.038	31.750	3.5	3.3	257 000	310 000	2 000	2 800	9380	9321	105	98	147	164	3.5	3.3	54.1	0.76	0.79	0.43	3.47	1.51			
	177.800	55.562	50.800	34.925	3.5	3.3	257 000	310 000	2 000	2 800	9378	9320	105	98	148	164	3.5	3.3	57.3	0.76	0.79	0.43	3.71	2.24			
77.788	121.442	24.608	23.012	17.462	3.5	2.0	89 000	124 000	2 800	3 800	34306	34478	90	84	110	116	3.5	2	26.3	0.45	1.3	0.73	0.612	0.316			
	127.000	30.162	31.000	22.225	3.5	3.3	134 000	195 000	2 800	3 800	42690	42620	91	85	114	121	3.5	3.3	27.3	0.42	1.4	0.79	0.976	0.438			
	135.733	44.450	46.101	34.925	3.5	3.3	216 000	340 000	2 600	3 600	5795	5735	96	89	119	130	3.5	3.3	32.9	0.41	1.5	0.81	1.79	0.887			
79.375	146.050	41.275	41.275	31.750	3.5	3.3	207 000	296 000	2 400	3 200	661	653	96	90	131	139	3.5	3.3	33.2	0.41	1.5	0.81	1.99	0.891			
	150.089	44.450	46.672	36.512	3.5	3.3	265 000	370 000	2 400	3 200	750	742	96	90	134	142	3.5	3.3	32.5	0.33	1.8	1.0	2.42	1.07			
80.000	130.000	35.000	34.000	28.500	3.0	2.5	166 000	251 000	2 600	3 600	▲ JM 515649	▲ JM 515610	94	88	117	125	3	2.5	29.9	0.39	1.5	0.85	1.18	0.583			
80.962	136.525	30.162	29.769	22.225	3.5	3.3	130 000	192 000	2 600	3 400	496	493	95	89	122	130	3.5	3.3	28.7	0.44	1.4	0.74	1.13	0.55			
	139.700	36.512	36.098	28.575	3.5	3.3	175 000	260 000	2 600	3 400	581	572 X	96	90	125	133	3.5	3.3	31.1	0.40	1.5	0.82	1.44	0.774			
	139.992	36.512	36.098	28.575	3.5	3.3	175 000	260 000	2 600	3 400	581	572	96	90	125	133	3.5	3.3	31.1	0.40	1.5	0.82	1.44	0.788			
82.550	125.412	25.400	25.400	19.845	3.5	1.5	102 000	164 000	2 600	3 600	27687	27620	96	89	115	120	3.5	1.5	25.7	0.42	1.4	0.79	0.747	0.348			
	133.350	30.162	29.769	22.225	3.5	3.3	130 000	192 000	2 600	3 400	495	492 A	97	90	120	128	3.5	3.3	28.7	0.44	1.4	0.74	1.08	0.434			
	133.350	33.338	33.338	26.195	3.5	3.3	154 000	237 000	2 600	3 600	47686	47620	97	90	119	128	3.5	3.3	29.0	0.40	1.5	0.82	1.18	0.577			
	133.350	33.338	33.338	26.195	0.8	3.3	154 000	237 000	2 600	3 600	47685	47620	90	90	119	128	0.8	3.3	29.0	0.40	1.5	0.82	1.18	0.577			
	133.350	33.338	33.338	26.195	6.8	3.3	154 000	237 000	2 600	3 600	47687	47620	103	90	119	128	6.8	3.3	29.0	0.40	1.5	0.82	1.16	0.577			
	133.350	39.688	39.688	32.545	6.8	3.3	179 000	310 000	2 600	3 600	HM 516448	HM 516410	105	92	118	128	6.8	3.3	32.4	0.40	1.5	0.82	1.35	0.767			
	136.525	30.162	29.769	22.225	3.5	3.3	130 000	192 000	2 600	3 400	495	493	97	90	122	130	3.5	3.3	28.7	0.44	1.4	0.74	1.08	0.55			
	139.700	36.512	36.098	28.575	3.5	3.3	175 000	260 000	2 600	3 400	580	572 X	98	91	125	133	3.5	3.3	31.1	0.40	1.5	0.82	1.39	0.774			
	139.992	36.512	36.098	28.575	3.5	3.3	175 000	260 000	2 600	3 400	580	572	98	91	125	133	3.5	3.3	31.1	0.40	1.5	0.82	1.39	0.788			
	139.992	36.512	36.098	28.575	6.8	3.3	175 000	260 000	2 600	3 400	582	572	104	91	125	133	6.8	3.3	31.1	0.40	1.5	0.82	1.37	0.788			
	146.050	41.275	41.275	31.750	3.5	3.3	207 000	296 000	2 400	3 200	663	653	99	92	131	139	3.5	3.3	33.2	0.41	1.5	0.81	1.85	0.891			
	150.000	44.455	46.672	35.000	3.5	3.3	265 000	370 000	2 400	3 200	749 A	743	99	93	134	142	3.5	3.3	32.5	0.33	1.8	1.0	2.26	1.04			
150.089	44.450	46.672	36.512	3.5	3.3	265 000	370 000	2 400	3 200	749 A	742	98	93	135	143	3.5	3.3	32.5	0.33	1.8	1.0	2.26	1.07				
152.400	41.275	41.275	31.750	3.5	3.3	207 000	296 000	2 400	3 200	663	652	99	92	134	141	3.5	3.3	33.2	0.41	1.5	0.81	1.85	1.26				
161.925	47.625	48.260	38.100	3.5	3.3	274 000	390 000	2 200	3 000	757	752	100	94	144	150	3.5	3.3	35.6	0.34	1.8	0.97	2.79	1.61				
161.925	53.975	55.100	42.862	3.5	3.3	325 000	480 000	2 200	3 000	6559	6535	104	98	141	154	3.5	3.3	40.7	0.40	1.5	0.82	3.4	1.67				
168.275	47.625	48.260	38.100	3.5	3.3	274 000	390 000	2 200	3 000	757	753	100	94	147	150	3.5	3.3	35.6	0.34	1.8	0.97	2.79	2.1				
168.275	53.975	56.363	41.275	3.5	3.3	345 000	470 000	2 200	3 000	842	832	101	94	149	155	3.5	3.3	35.2	0.30	2.0	1.1	3.76	1.74				
83.345	125.412	25.400	25.400	19.845	3.5	1.5	102 000	164 000	2 600	3 600	27690	27620	96	90	115	120	3.5	1.5	25.7	0.42	1.4	0.79	0.727	0.348			
	125.412	25.400	25.400	19.845	0.8	1.5	102 000	164 000	2 600	3 600	27689	27620	90	90	115	120	0.8	1.5	25.7	0.42	1.4	0.79	0.732	0.348			

Note ▲ Tolerances are listed in Tables 2, 3, and 4 on Pages C184 and C185.

■ SINGLE-ROW TAPERED ROLLER BEARINGS (INCH SERIES)

Bore Diameter 84.138 – 90.488 mm

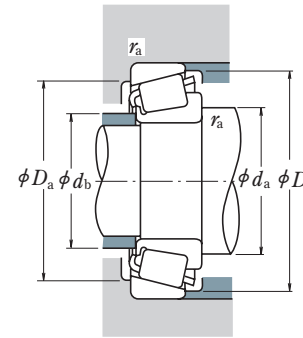
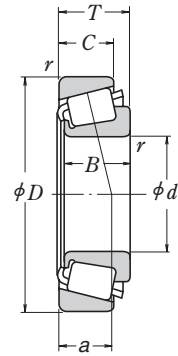

Dynamic Equivalent Load

$$P = XF_r + YF_a$$

$F_a/F_r \leq e$		$F_a/F_r > e$	
X	Y	X	Y
1	0	0.4	Y_1

Static Equivalent Load

$$P_0 = 0.5F_r + Y_0F_a$$

When $F_r > 0.5F_r + Y_0F_a$, use $P_0 = F_r$

The values of e , Y_1 , and Y_0 are given in the table below.

d	Boundary Dimensions (mm)				Ring:		Basic Load Ratings (N)		Limiting Speeds (min ⁻¹)		Bearing Designations		Abutment and Fillet Dimensions (mm)				Eff. Load Center (mm)	Constant e	Axial Load Factors		Mass (kg)			
	D	T	B	C	Inner	Outer	C _r	C _{0r}	Grease	Oil	INNER RING	OUTER RING	d _a	d _b	D _a	D _b			Inner	Outer	Y ₁	Y ₀	Inner	Outer
84.138	136.525	30.162	29.769	22.225	3.5	3.3	130 000	192 000	2 600	3 400	498	493	98	91	122	130	3.5	3.3	28.7	0.44	1.4	0.74	1.04	0.55
	146.050	41.275	41.275	31.750	3.5	3.3	207 000	296 000	2 400	3 200	664	653	99	93	131	139	3.5	3.3	33.2	0.41	1.5	0.81	1.79	0.891
	171.450	49.212	46.038	31.750	3.5	3.3	257 000	310 000	2 000	2 800	9385	9321	111	98	147	164	3.5	3.3	54.1	0.76	0.79	0.43	3.11	1.51
85.000	130.000	30.000	29.000	24.000	6.0	2.5	138 000	222 000	2 600	3 600	▲ JM 716648	▲ JM 716610	104	92	117	125	6	2.5	29.5	0.44	1.4	0.74	0.931	0.461
	130.000	30.000	29.000	24.000	3.0	2.5	138 000	222 000	2 600	3 600	▲ JM 716649	▲ JM 716610	98	92	117	125	3	2.5	29.5	0.44	1.4	0.74	0.943	0.461
	140.000	39.000	38.000	31.500	3.0	2.5	202 000	305 000	2 400	3 400	▲ JHM 516849	▲ JHM 516810	100	94	125	134	3	2.5	33.3	0.41	1.5	0.81	1.55	0.768
85.026	150.000	46.000	46.000	38.000	3.0	2.5	275 000	390 000	2 400	3 200	▲ JH 217249	▲ JH 217210	101	95	134	142	3	2.5	33.9	0.33	1.8	0.99	2.29	1.09
	150.089	44.450	46.672	36.512	3.5	3.3	265 000	370 000	2 400	3 200	749	742	101	95	134	142	3.5	3.3	32.5	0.33	1.8	1.0	2.14	1.07
	150.089	44.450	46.672	36.512	5.0	3.3	265 000	370 000	2 400	3 200	749 S	742	104	95	134	142	5	3.3	32.5	0.33	1.8	1.0	2.14	1.07
85.725	133.350	30.162	29.769	22.225	3.5	3.3	130 000	192 000	2 600	3 400	497	492 A	99	93	120	128	3.5	3.3	28.7	0.44	1.4	0.74	0.987	0.434
	136.525	30.162	29.769	22.225	3.5	3.3	130 000	192 000	2 600	3 400	497	493	99	93	122	130	3.5	3.3	28.7	0.44	1.4	0.74	0.987	0.55
	142.138	42.862	42.862	34.133	4.8	3.3	221 000	360 000	2 400	3 400	HM 617049	HM 617010	106	95	125	137	4.8	3.3	35.4	0.43	1.4	0.76	1.77	0.911
87.312	146.050	41.275	41.275	31.750	6.4	3.3	207 000	296 000	2 400	3 200	665 A	653	107	95	131	139	6.4	3.3	33.2	0.41	1.5	0.81	1.71	0.891
	146.050	41.275	41.275	31.750	3.5	3.3	207 000	296 000	2 400	3 200	665	653	102	95	131	139	3.5	3.3	33.2	0.41	1.5	0.81	1.72	0.891
	152.400	39.688	36.322	30.162	3.5	3.2	183 000	285 000	2 200	3 200	596	592 A	102	96	135	144	3.5	3.2	37.1	0.44	1.4	0.75	1.85	1.06
88.900	161.925	47.625	48.260	38.100	3.5	3.3	274 000	390 000	2 200	3 000	758	752	103	97	144	150	3.5	3.3	35.6	0.34	1.8	0.97	2.63	1.61
	168.275	41.275	41.275	30.162	3.5	3.3	223 000	345 000	2 000	2 800	677	672	105	99	149	160	3.5	3.3	38.3	0.47	1.3	0.70	2.91	1.24
	190.500	57.150	57.531	46.038	8.0	3.3	390 000	520 000	1 900	2 600	HH 221432	HH 221410	118	103	171	179	8	3.3	42.3	0.33	1.8	0.99	5.51	2.24
90.000	149.225	31.750	28.971	24.608	3.0	3.3	140 000	218 000	2 200	3 000	42350	42587	104	98	134	143	3	3.3	34.9	0.49	1.2	0.67	1.39	0.711
	152.400	39.688	36.322	30.162	3.5	3.2	183 000	285 000	2 200	3 200	593	592 A	104	98	135	144	3.5	3.2	37.1	0.44	1.4	0.75	1.73	1.06
	152.400	39.688	39.688	30.162	6.4	3.3	253 000	365 000	2 200	3 200	HM 518445	HM 518410	107	96	137	148	6.4	3.3	33.1	0.40	1.5	0.82	2.11	0.776
90.488	161.925	47.625	48.260	38.100	3.5	3.3	274 000	390 000	2 200	3 000	759	752	106	99	144	150	3.5	3.3	35.6	0.34	1.8	0.97	2.47	1.61
	161.925	47.625	48.260	38.100	7.0	3.3	274 000	390 000	2 200	3 000	766	752	113	99	144	150	7	3.3	35.6	0.34	1.8	0.97	2.45	1.61
	161.925	53.975	55.100	42.862	3.5	3.3	325 000	480 000	2 200	3 000	6580	6535	109	102	141	154	3.5	3.3	40.7	0.40	1.5	0.82	3.03	1.67
90.488	168.275	47.625	48.260	38.100	3.5	3.3	274 000	390 000	2 200	3 000	759	753	106	99	147	150	3.5	3.3	35.6	0.34	1.8	0.97	2.47	2.1
	168.275	53.975	56.363	41.275	3.5	3.3	345 000	470 000	2 200	3 000	850	832	106	100	149	155	3.5	3.3	35.2	0.30	2.0	1.1	3.39	1.74
	190.500	57.150	57.531	44.450	8.0	3.3	355 000	500 000	1 900	2 600	855	854	118	103	170	174	8	3.3	41.8	0.33	1.8	0.99	4.99	2.55
90.488	145.000	35.000	34.000	27.000	3.0	2.5	190 000	285 000	1 900	2 600	HH 221434	HH 221410	120	105	171	179	8	3.3	42.3	0.33	1.8	0.99	5.41	2.24
	147.000	40.000	40.000	32.500	7.0	3.5	229 000	345 000	2 400	3 200	▲ JM 718149	▲ JM 718110	105	99	131	139	3	2.5	33.0	0.44	1.4	0.74	1.49	0.66
	155.000	44.000	44.000	35.500	3.0	2.5	274 000	390 000	2 200	3 000	*HM 218248	**HM 218210	111	98	133	141	7	3.5	30.8	0.33	1.8	0.99	1.77	0.796
90.488	161.925	47.625	48.260	38.100	3.5	3.3	274 000	390 000	2 200	3 000	▲ JHM 318448	▲ JHM 318410	106	100	140	148	3	2.5	34.1	0.34	1.7	0.96	2.32	1.01
	161.925	47.625	48.260	38.100	3.5	3.3	274 000	390 000	2 200	3 000	760	752	107	101	144	150	3.5	3.3	35.6	0.34	1.8	0.97	2.38	1.61

Notes * The maximum bore diameter is listed and its tolerance is negative (see Table 7.4.1 on Page A136).
 ** The maximum outside diameter is listed and its tolerance is negative (see Table 7.4.2 on Pages A136 and A137).
 ▲ Tolerances are listed in Tables 2, 3, and 4 on Pages C184 and C185.

■ SINGLE-ROW TAPERED ROLLER BEARINGS (INCH SERIES)

Bore Diameter 92.075 – 100.012 mm

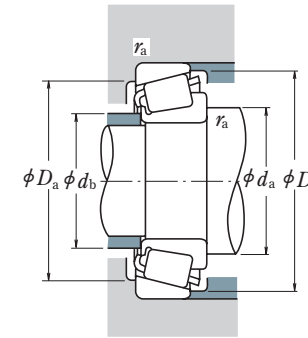
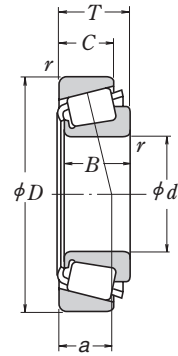

Dynamic Equivalent Load

$$P = XF_r + YF_a$$

$F_a/F_r \leq e$		$F_a/F_r > e$	
X	Y	X	Y
1	0	0.4	Y_1

Static Equivalent Load

$$P_0 = 0.5F_r + Y_0F_a$$

When $F_r > 0.5F_r + Y_0F_a$, use $P_0 = F_r$

The values of e , Y_1 , and Y_0 are given in the table below.

Boundary Dimensions (mm)					Ring:		Basic Load Ratings (N)		Limiting Speeds (min ⁻¹)		Bearing Designations		Abutment and Fillet Dimensions (mm)				Eff. Load Center (mm)	Constant	Axial Load Factors		Mass (kg)			
d	D	T	B	C	Inner	Outer	C_r	C_{0r}	Grease	Oil	INNER RING	OUTER RING	d_a	d_b	D_a	D_b	a	e	Y_1	Y_0	Inner Ring	Outer Ring		
					r	r_{min}															approx.			
92.075	146.050	33.338	34.925	26.195	3.5	3.3	169 000	280 000	2 400	3 200	47890	47820	107	101	131	140	3.5	3.3	32.3	0.45	1.3	0.74	1.46	0.664
	148.430	28.575	28.971	21.433	3.5	3.0	140 000	218 000	2 200	3 000	42362	42584	107	101	134	142	3.5	3	31.8	0.49	1.2	0.67	1.29	0.553
	152.400	39.688	36.322	30.162	3.5	3.2	183 000	285 000	2 200	3 200	598	592 A	107	101	135	144	3.5	3.2	37.1	0.44	1.4	0.75	1.6	1.06
	152.400	39.688	36.322	30.162	6.4	3.2	183 000	285 000	2 200	3 200	598 A	592 A	113	101	135	144	6.4	3.2	37.1	0.44	1.4	0.75	1.59	1.06
	168.275	41.275	41.275	30.162	3.5	3.3	223 000	345 000	2 000	2 800	681	672	110	104	149	160	3.5	3.3	38.3	0.47	1.3	0.70	2.62	1.24
	190.500	57.150	57.531	44.450	8.0	3.3	355 000	500 000	1 900	2 600	857	854	121	106	170	174	8	3.3	41.8	0.33	1.8	0.99	4.78	2.55
93.662	148.430	28.575	28.971	21.433	3.0	3.0	140 000	218 000	2 200	3 000	42368	42584	107	102	134	142	3	3	31.8	0.49	1.2	0.67	1.24	0.553
	149.225	31.750	28.971	24.608	3.0	3.3	140 000	218 000	2 200	3 000	42368	42587	107	102	134	143	3	3.3	34.9	0.49	1.2	0.67	1.24	0.711
	152.400	39.688	36.322	30.162	3.5	3.2	183 000	285 000	2 200	3 200	597	592 A	109	102	135	144	3.5	3.2	37.1	0.44	1.4	0.75	1.54	1.06
95.000	150.000	35.000	34.000	27.000	3.0	2.5	183 000	285 000	2 200	3 200	▲ JM 719149	▲ JM 719113	109	104	135	143	3	2.5	33.4	0.44	1.4	0.75	1.46	0.765
95.250	146.050	33.338	34.925	26.195	3.5	3.3	169 000	280 000	2 400	3 200	47896	47820	110	103	131	140	3.5	3.3	32.3	0.45	1.3	0.74	1.33	0.664
	148.430	28.575	28.971	21.433	3.0	3.0	140 000	218 000	2 200	3 000	42375	42584	108	103	134	142	3	3	31.8	0.49	1.2	0.67	1.18	0.553
	149.225	31.750	28.971	24.608	3.5	3.3	140 000	218 000	2 200	3 000	42376	42587	109	103	134	143	3.5	3.3	34.9	0.49	1.2	0.67	1.18	0.711
	152.400	39.688	36.322	30.162	3.5	3.2	183 000	285 000	2 200	3 200	594	592 A	110	104	135	144	3.5	3.2	37.1	0.44	1.4	0.75	1.47	1.06
	152.400	39.688	36.322	33.338	3.5	3.3	183 000	285 000	2 200	3 200	594	592	109	103	135	145	3.5	3.3	37.1	0.44	1.4	0.75	1.47	1.12
	168.275	41.275	41.275	30.162	3.5	3.3	223 000	345 000	2 000	2 800	683	672	113	106	149	160	3.5	3.3	38.3	0.47	1.3	0.70	2.47	1.24
	171.450	47.625	48.260	38.100	3.5	3.3	282 000	415 000	2 000	2 800	77375	77675	117	105	152	159	3.5	3.3	37.8	0.37	1.6	0.90	2.91	1.67
	180.975	47.625	48.006	38.100	3.5	3.3	258 000	375 000	2 000	2 600	776	772	114	107	161	168	3.5	3.3	39.1	0.39	1.6	0.86	3.25	1.99
	190.500	57.150	57.531	44.450	8.0	3.3	355 000	500 000	1 900	2 600	864	854	123	108	170	174	8	3.3	41.8	0.33	1.8	0.99	4.57	2.55
	190.500	57.150	57.531	46.038	8.0	3.3	390 000	520 000	1 900	2 600	HH 221440	HH 221410	125	110	171	179	8	3.3	42.3	0.33	1.8	0.99	5.0	2.24
96.838	148.430	28.575	28.971	21.433	3.5	3.0	140 000	218 000	2 200	3 000	42381	42584	110	104	134	142	3.5	3	31.8	0.49	1.2	0.67	1.13	0.553
	149.225	31.750	28.971	24.606	3.5	3.3	140 000	218 000	2 200	3 000	42381	42587	111	105	135	143	3.5	3.3	34.9	0.49	1.2	0.67	1.13	0.711
98.425	161.925	36.512	36.116	26.195	3.5	3.3	191 000	310 000	2 000	2 800	52387	52637	114	108	144	154	3.5	3.3	36.1	0.47	1.3	0.69	1.89	0.942
	168.275	41.275	41.275	30.162	3.5	3.3	223 000	345 000	2 000	2 800	685	672	116	109	149	160	3.5	3.3	38.3	0.47	1.3	0.70	2.32	1.24
	180.975	47.625	48.006	38.100	3.5	3.3	258 000	375 000	2 000	2 600	779	772	116	110	161	168	3.5	3.3	39.1	0.39	1.6	0.86	3.06	1.99
	190.500	57.150	57.531	44.450	3.5	3.3	355 000	500 000	1 900	2 600	866	854	118	111	170	174	3.5	3.3	41.8	0.33	1.8	0.99	4.38	2.55
99.982	190.500	57.150	57.531	46.038	3.5	3.3	390 000	520 000	1 900	2 600	HH 221442	HH 221410	119	113	171	179	3.5	3.3	42.3	0.33	1.8	0.99	4.81	2.24
	190.500	57.150	57.531	46.038	6.4	3.3	390 000	520 000	1 900	2 600	HH 221447	HH 221410	126	114	171	179	6.4	3.3	42.3	0.33	1.8	0.99	4.68	2.24
100.000	150.000	32.000	30.000	26.000	2.3	2.3	146 000	235 000	2 200	3 000	▲ JLM 820048	▲ JLM 820012	111	107	135	144	2.3	2.3	36.8	0.50	1.2	0.66	1.27	0.616
	155.000	36.000	35.000	28.000	3.0	2.5	191 000	325 000	2 000	2 800	▲ JM 720249	▲ JM 720210	115	109	140	149	3	2.5	36.8	0.47	1.3	0.70	1.68	0.772
	160.000	41.000	40.000	32.000	3.0	2.5	239 000	380 000	2 000	2 800	▲ JHM 720249	▲ JHM 720210	117	109	143	154	3	2.5	38.2	0.47	1.3	0.70	2.09	0.974
100.012	157.162	36.512	36.116	26.195	3.5	3.3	191 000	310 000	2 000	2 800	52393	52618	116	109	142	152	3.5	3.3	36.1	0.47	1.3	0.69	1.81	0.702

Note ▲ Tolerances are listed in Tables 2, 3, and 4 on Pages C184 and C185.

■ SINGLE-ROW TAPERED ROLLER BEARINGS (INCH SERIES)

Bore Diameter 101.600 – 117.475 mm

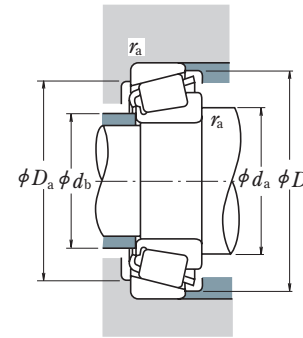
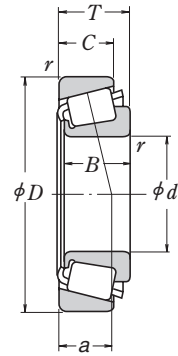

Dynamic Equivalent Load

$$P = XF_r + YF_a$$

$F_a/F_r \leq e$		$F_a/F_r > e$	
X	Y	X	Y
1	0	0.4	Y_1

Static Equivalent Load

$$P_0 = 0.5F_r + Y_0F_a$$

When $F_r > 0.5F_r + Y_0F_a$, use $P_0 = F_r$

The values of e , Y_1 , and Y_0 are given in the table below.

d	Boundary Dimensions (mm)				Ring:		Basic Load Ratings (N)		Limiting Speeds (min ⁻¹)		Bearing Designations		Abutment and Fillet Dimensions (mm)				Eff. Load Center (mm) a	Constant e	Axial Load Factors		Mass (kg)		
	D	T	B	C	Inner r min.	Outer r	C _r	C _{0r}	Grease	Oil	INNER RING	OUTER RING	d _a	d _b	D _a	D _b			Inner r min.	Outer r max.	Y ₁	Y ₀	Inner
101.600	157.162	36.512	36.116	26.195	3.5	3.3	191 000	310 000	2 000	2 800	52400	52618	117	111	142	152	3.5	3.3	0.47	0.69	1.75	0.702	
	161.925	36.512	36.116	26.195	3.5	3.3	191 000	310 000	2 000	2 800	52400	52637	117	111	144	154	3.5	3.3	0.47	0.69	1.75	0.942	
	168.275	41.275	41.275	30.162	3.5	3.3	223 000	345 000	2 000	2 800	687	672	118	112	149	160	3.5	3.3	0.47	0.70	2.15	1.24	
	180.975	47.625	48.006	38.100	3.5	3.3	258 000	375 000	2 000	2 600	780	772	119	113	161	168	3.5	3.3	0.39	0.86	2.88	1.99	
	190.500	57.150	57.531	44.450	8.0	3.3	355 000	500 000	1 900	2 600	861	854	129	114	170	174	8	3.3	0.33	1.8	0.99	4.13	2.55
	190.500	57.150	57.531	46.038	8.0	3.3	390 000	520 000	1 900	2 600	HH 221449	HH 221410	131	116	171	179	8	3.3	0.33	1.8	0.99	4.55	2.24
212.725	66.675	66.675	53.975	7.0	3.3	570 000	810 000	1 700	2 200	HH 224335	HH 224310	132	121	192	202	7	3.3	0.33	1.8	1.0	8.14	3.06	
104.775	180.975	47.625	48.006	38.100	7.0	3.3	258 000	375 000	2 000	2 600	787	772	129	116	161	168	7	3.3	0.39	0.86	2.66	1.99	
	180.975	47.625	48.006	38.100	3.5	3.3	258 000	375 000	2 000	2 600	782	772	122	116	161	168	3.5	3.3	0.39	0.86	2.68	1.99	
	190.500	47.625	49.212	34.925	3.5	3.3	296 000	465 000	1 800	2 400	71412	71750	124	118	171	181	3.5	3.3	0.42	0.79	4.0	1.71	
106.362	165.100	36.512	36.512	26.988	3.5	3.3	195 000	320 000	2 000	2 600	56418	56650	122	116	149	159	3.5	3.3	0.50	0.66	1.87	0.861	
107.950	158.750	23.020	21.438	15.875	3.5	3.3	102 000	165 000	2 000	2 800	37425	37625	122	115	143	152	3.5	3.3	0.61	0.54	0.886	0.488	
	159.987	34.925	34.925	26.988	3.5	3.3	164 000	315 000	2 000	2 800	LM 522546	LM 522510	122	116	146	154	3.5	3.3	0.40	0.82	1.65	0.784	
	161.925	34.925	34.925	26.988	3.5	3.3	164 000	280 000	2 000	2 800	48190	48120	122	116	146	156	3.5	3.3	0.51	0.65	1.59	0.83	
165.100	36.512	36.512	26.988	3.5	3.3	195 000	320 000	2 000	2 600	56425	56650	123	117	149	159	3.5	3.3	0.50	0.66	1.8	0.861		
190.500	47.625	49.212	34.925	3.5	3.3	296 000	465 000	1 800	2 400	71425	71750	126	120	171	181	3.5	3.3	0.42	0.79	3.79	1.71		
212.725	66.675	66.675	53.975	8.0	3.3	570 000	810 000	1 700	2 200	HH 224340	HH 224310	139	126	192	202	8	3.3	0.33	1.8	1.0	7.58	3.06	
109.987	159.987	34.925	34.925	26.988	3.5	3.3	164 000	315 000	2 000	2 800	LM 522549	LM 522510	124	118	146	154	3.5	3.3	0.40	0.82	1.55	0.784	
	159.987	34.925	34.925	26.988	8.0	3.3	164 000	315 000	2 000	2 800	LM 522548	LM 522510	133	118	146	154	8	3.3	0.40	0.82	1.53	0.784	
109.992	177.800	41.275	41.275	30.162	3.5	3.3	232 000	375 000	1 800	2 600	64433	64700	128	121	160	172	3.5	3.3	0.52	0.64	2.64	1.11	
110.000	165.000	35.000	35.000	26.500	3.0	2.5	195 000	320 000	2 000	2 600	▲ JM 822049	▲ JM 822010	124	119	149	159	3	2.5	0.50	0.66	1.64	0.842	
	180.000	47.000	46.000	38.000	3.0	2.5	310 000	490 000	1 900	2 600	▲ JHM 522649	▲ JHM 522610	127	122	162	172	3	2.5	0.41	0.81	3.12	1.51	
111.125	190.500	47.625	49.212	34.925	3.5	3.3	296 000	465 000	1 800	2 400	71437	71750	129	123	171	181	3.5	3.3	0.42	0.79	3.58	1.71	
114.300	152.400	21.433	21.433	16.670	1.5	1.5	89 500	178 000	2 000	2 800	L 623149	L 623110	123	121	143	148	1.5	1.5	0.41	0.80	0.725	0.344	
	177.800	41.275	41.275	30.162	3.5	3.3	232 000	375 000	1 800	2 600	64450	64700	131	125	160	172	3.5	3.3	0.52	0.64	2.39	1.11	
	180.000	34.925	31.750	25.400	3.5	0.8	174 000	254 000	1 800	2 400	68450	** 68709	130	123	165	172	3.5	0.8	0.50	0.66	1.95	1.0	
190.500	47.625	49.212	34.925	3.5	3.3	296 000	465 000	1 800	2 400	71450	71750	132	125	171	181	3.5	3.3	0.41	0.79	3.37	1.71		
212.725	66.675	66.675	53.975	7.0	3.3	475 000	700 000	1 700	2 400	938	932	141	128	187	193	7	3.3	0.33	1.8	1.0	6.01	4.11	
212.725	66.675	66.675	53.975	7.0	3.3	570 000	810 000	1 700	2 200	HH 224346	HH 224310	143	131	192	202	7	3.3	0.33	1.8	1.0	7.01	3.06	
115.087	190.500	47.625	49.212	34.925	3.5	3.3	296 000	465 000	1 800	2 400	71453	71750	133	126	171	181	3.5	3.3	0.42	0.79	3.31	1.71	
117.475	180.975	34.925	31.750	25.400	3.5	3.3	174 000	254 000	1 800	2 400	68462	68712	132	125	163	172	3.5	3.3	0.50	0.66	1.73	1.05	

Notes ** The maximum outside diameter is listed and its tolerance is negative (see Table 7.4.2 on Pages A136 and A137).
▲ Tolerances are listed in Tables 2, 3, and 4 on Pages C184 and C185.

■ SINGLE-ROW TAPERED ROLLER BEARINGS (INCH SERIES)

Bore Diameter 120.000 – 165.100 mm

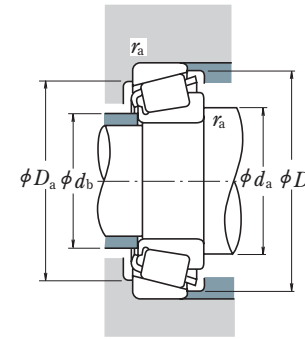
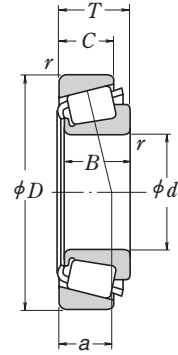

Dynamic Equivalent Load

$$P = XF_r + YF_a$$

$F_a/F_r \leq e$		$F_a/F_r > e$	
X	Y	X	Y
1	0	0.4	Y_1

Static Equivalent Load

$$P_0 = 0.5F_r + Y_0F_a$$

When $F_r > 0.5F_r + Y_0F_a$, use $P_0 = F_r$

The values of e , Y_1 , and Y_0 are given in the table below.

Boundary Dimensions (mm)					Ring:		Basic Load Ratings (N)		Limiting Speeds (min^{-1})		Bearing Designations		Abutment and Fillet Dimensions (mm)				Eff. Load Center (mm)	Constant	Axial Load Factors		Mass (kg)			
d	D	T	B	C	Inner	Outer	C_r	C_{0r}	Grease	Oil	INNER RING	OUTER RING	d_a	d_b	D_a	D_b	Inner	Outer	a	e	Y_1	Y_0	approx.	
					r	r																	Inner	Outer
					min.	max.																		
120.000	170.000	25.400	25.400	19.050	3.3	3.3	130 000	219 000	1 900	2 600	▲ JL 724348	▲ JL 724314	132	127	156	163	3.3	3.3	32.9	0.46	1.3	0.72	1.08	0.591
	174.625	35.720	36.512	27.783	3.5	1.5	212 000	385 000	1 900	2 600	* M 224748	M 224710	135	129	163	168	3.5	1.5	32.2	0.33	1.8	0.99	1.9	0.866
120.650	182.562	39.688	38.100	33.338	3.5	3.3	228 000	445 000	1 800	2 400	48282	48220	136	133	168	176	3.5	3.3	34.2	0.31	2.0	1.1	2.56	1.14
	206.375	47.625	47.625	34.925	3.3	3.3	320 000	530 000	1 600	2 200	795	792	139	134	186	198	3.3	3.3	45.7	0.46	1.3	0.72	4.44	1.9
123.825	182.562	39.688	38.100	33.338	3.5	3.3	228 000	445 000	1 800	2 400	48286	48220	139	133	168	176	3.5	3.3	34.2	0.31	2.0	1.1	2.37	1.14
125.000	175.000	25.400	25.400	18.288	3.3	3.3	134 000	232 000	1 800	2 400	▲ JL 725346	▲ JL 725316	138	133	161	168	3.3	3.3	34.3	0.48	1.3	0.69	1.19	0.573
127.000	165.895	18.258	17.462	13.495	1.5	1.5	84 500	149 000	1 900	2 600	LL 225749	LL 225710	135	132	158	160	1.5	1.5	24.2	0.33	1.8	0.99	0.647	0.288
	182.562	39.688	38.100	33.338	3.5	3.3	228 000	445 000	1 800	2 400	48290	48220	141	135	168	176	3.5	3.3	34.2	0.31	2.0	1.1	2.19	1.14
	196.850	46.038	46.038	38.100	3.5	3.3	315 000	560 000	1 700	2 200	67388	67322	144	138	180	189	3.5	3.3	39.7	0.34	1.7	0.96	3.74	1.46
	215.900	47.625	47.625	34.925	3.5	3.3	287 000	495 000	1 500	2 000	74500	74850	148	141	196	208	3.5	3.3	48.4	0.49	1.2	0.68	4.92	1.99
128.588	206.375	47.625	47.625	34.925	3.3	3.3	320 000	530 000	1 600	2 200	799	792	146	140	186	198	3.3	3.3	45.7	0.46	1.3	0.72	3.86	1.9
130.000	206.375	47.625	47.625	34.925	3.5	3.3	320 000	530 000	1 600	2 200	797	792	148	141	186	198	3.5	3.3	45.7	0.46	1.3	0.72	3.76	1.9
130.175	203.200	46.038	46.038	38.100	3.5	3.3	315 000	560 000	1 700	2 200	67389	67320	146	141	183	191	3.5	3.3	39.7	0.34	1.7	0.96	3.51	2.06
	206.375	47.625	47.625	34.925	3.5	3.3	320 000	530 000	1 600	2 200	799 A	792	148	142	186	198	3.5	3.3	45.7	0.46	1.3	0.72	3.74	1.9
133.350	177.008	25.400	26.195	20.638	1.5	1.5	124 000	258 000	1 800	2 400	L 327249	L 327210	143	141	167	171	1.5	1.5	29.5	0.35	1.7	0.95	1.18	0.55
	190.500	39.688	39.688	33.338	3.5	3.3	240 000	485 000	1 700	2 200	48385	48320	148	142	177	184	3.5	3.3	35.9	0.32	1.9	1.0	2.58	1.16
	196.850	46.038	46.038	38.100	3.5	3.3	315 000	560 000	1 700	2 200	67390	67322	149	143	180	189	3.5	3.3	39.7	0.34	1.7	0.96	3.27	1.46
	215.900	47.625	47.625	34.925	3.5	3.3	287 000	495 000	1 500	2 000	74525	74850	152	146	196	208	3.5	3.3	48.4	0.49	1.2	0.68	4.44	1.99
136.525	190.500	39.688	39.688	33.338	3.5	3.3	216 000	440 000	1 700	2 200	48393	48320	151	144	177	184	3.5	3.3	35.9	0.32	1.9	1.0	2.31	1.16
	217.488	47.625	47.625	34.925	3.5	3.3	287 000	495 000	1 500	2 000	74537	74856	155	148	197	210	3.5	3.3	48.4	0.49	1.2	0.68	4.19	2.13
139.700	187.325	28.575	29.370	23.020	1.5	1.5	153 000	305 000	1 700	2 200	LM 328448	LM 328410	149	147	176	182	1.5	1.5	31.7	0.36	1.7	0.93	1.59	0.67
	215.900	47.625	47.625	34.925	3.5	3.3	287 000	495 000	1 500	2 000	74550	74850	158	151	196	208	3.5	3.3	48.4	0.49	1.2	0.68	3.93	1.99
	254.000	66.675	66.675	47.625	7.0	3.3	515 000	830 000	1 300	1 800	99550	99100	170	156	227	238	7	3.3	55.3	0.41	1.5	0.81	9.99	3.83
142.875	200.025	41.275	39.688	34.130	3.5	3.3	227 000	460 000	1 600	2 200	48685	48620	158	151	185	193	3.5	3.3	37.6	0.34	1.8	0.98	2.63	1.19
	193.675	28.575	28.575	23.020	1.5	1.5	170 000	355 000	1 600	2 200	36690	36620	155	154	182	188	1.5	1.5	33.5	0.37	1.6	0.90	1.64	0.725
146.050	236.538	57.150	56.642	44.450	3.5	3.3	455 000	720 000	1 400	1 900	HM 231140	HM 231110	164	160	217	224	3.5	3.3	45.9	0.32	1.9	1.0	6.07	2.93
	254.000	66.675	66.675	47.625	7.0	3.3	515 000	830 000	1 300	1 800	99575	99100	175	162	227	238	7	3.3	55.3	0.41	1.5	0.81	9.24	3.83
149.225	254.000	66.675	66.675	47.625	7.0	3.3	515 000	830 000	1 300	1 800	99587	99100	178	165	227	238	7	3.3	55.3	0.41	1.5	0.81	8.86	3.83
152.400	254.000	66.675	66.675	47.625	7.0	3.3	515 000	830 000	1 300	1 800	99600	99100	181	167	227	238	7	3.3	55.3	0.41	1.5	0.81	8.46	3.83
158.750	225.425	41.275	39.688	33.338	3.5	3.3	240 000	540 000	1 400	1 900	46780	46720	176	169	209	218	3.5	3.3	44.3	0.38	1.6	0.86	3.69	1.66
165.100	247.650	47.625	47.625	38.100	3.5	3.3	345 000	705 000	1 300	1 700	67780	67720	185	179	229	240	3.5	3.3	52.4	0.44	1.4	0.75	5.83	2.33

Notes * The maximum bore diameter is listed and its tolerance is negative (see Table 7.4.1 on Page A136).
▲ Tolerances are listed in Tables 2, 3, and 4 on Pages C184 and C185.

■ SINGLE-ROW TAPERED ROLLER BEARINGS (INCH SERIES)

Bore Diameter 170.000 – 206.375 mm

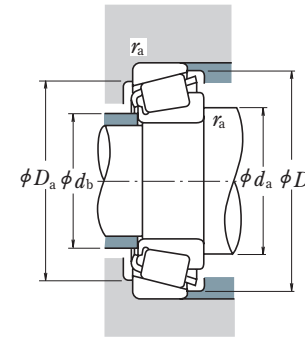
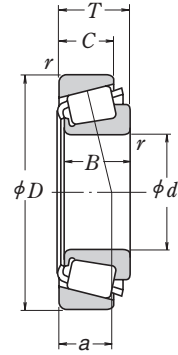

Dynamic Equivalent Load

$$P = XF_r + YF_a$$

$F_a/F_r \leq e$		$F_a/F_r > e$	
X	Y	X	Y
1	0	0.4	Y_1

Static Equivalent Load

$$P_0 = 0.5F_r + Y_0F_a$$

When $F_r > 0.5F_r + Y_0F_a$, use $P_0 = F_r$

The values of e , Y_1 , and Y_0 are given in the table below.

d	Boundary Dimensions (mm)				Ring:		Basic Load Ratings (N)		Limiting Speeds (min ⁻¹)		Bearing Designations		Abutment and Fillet Dimensions (mm)					Eff. Load Center (mm) a	Constant e	Axial Load Factors		Mass (kg)		
	D	T	B	C	Inner r min.	Outer r max.	C _r	C _{0r}	Grease	Oil	INNER RING	OUTER RING	d _a	d _b	D _a	D _b	Inner r min.			Outer r max.	Y ₁	Y ₀	Inner Ring	Outer Ring
170.000	230.000	39.000	38.000	31.000	3.0	2.5	278 000	520 000	1 300	1 800	▲ JHM 534149	▲ JHM 534110	184	178	217	224	3	2.5	43.2	0.38	1.6	0.86	3.1	1.3
	240.000	46.000	44.500	37.000	3.0	2.5	380 000	720 000	1 300	1 800	▲ JM 734449	▲ JM 734410	185	180	222	232	3	2.5	50.5	0.44	1.4	0.75	4.42	2.02
174.625	247.650	47.625	47.625	38.100	3.5	3.3	345 000	705 000	1 300	1 700	67787	67720	192	185	229	240	3.5	3.3	52.4	0.44	1.4	0.75	4.88	2.33
177.800	227.012	30.162	30.162	23.020	1.5	1.5	181 000	415 000	1 300	1 800	36990	36920	189	186	214	221	1.5	1.5	42.9	0.44	1.4	0.75	2.1	0.907
	247.650	47.625	47.625	38.100	3.5	3.3	345 000	705 000	1 300	1 700	67790	67720	194	188	229	240	3.5	3.3	52.4	0.44	1.4	0.75	4.56	2.33
	260.350	53.975	53.975	41.275	3.5	3.3	455 000	835 000	1 200	1 700	M 236849	M 236810	195	192	241	249	3.5	3.3	47.5	0.33	1.8	0.99	6.49	2.86
190.000	260.000	46.000	44.000	36.500	3.0	2.5	370 000	730 000	1 100	1 600	▲ JM 738249	▲ JM 738210	206	200	242	252	3	2.5	56.4	0.48	1.3	0.69	4.73	2.2
190.500	266.700	47.625	46.833	38.100	3.5	3.3	345 000	720 000	1 100	1 500	67885	67820	209	203	246	259	3.5	3.3	57.9	0.48	1.3	0.69	5.4	2.64
200.000	300.000	65.000	62.000	51.000	3.5	2.5	615 000	1 130 000	1 000	1 400	▲ JHM 840449	▲ JHM 840410	223	215	273	289	3.5	2.5	73.1	0.52	1.2	0.63	10.3	5.19
203.200	282.575	46.038	46.038	36.512	3.5	3.3	365 000	800 000	1 000	1 400	67983	67920	222	216	260	275	3.5	3.3	61.9	0.51	1.2	0.65	6.03	2.82
206.375	282.575	46.038	46.038	36.512	3.5	3.3	365 000	800 000	1 000	1 400	67985	67920	224	219	260	275	3.5	3.3	61.9	0.51	1.2	0.65	5.66	2.82

Note ▲ Tolerances are listed in Tables 2, 3, and 4 on Pages C184 and C185.

DOUBLE-ROW TAPERED ROLLER BEARINGS

Bore Diameter 40 – 90 mm

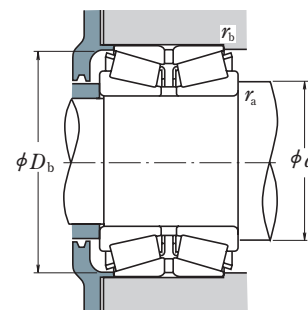
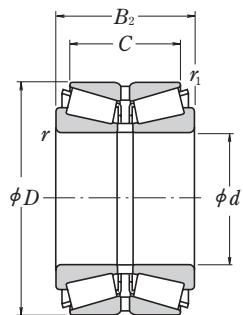

Dynamic Equivalent Load

$$P = XF_r + YF_a$$

$F_a/F_r \leq e$		$F_a/F_r > e$	
X	Y	X	Y
1	Y_3	0.67	Y_2

Static Equivalent Load

$$P_0 = F_r + Y_0 F_a$$

The values of e , Y_2 , Y_3 , and Y_0 are given in the table below.

d	Boundary Dimensions (mm)					Basic Load Ratings (N)		Limiting Speeds (min ⁻¹)		Bearing Designation	Abutment and Fillet Dimensions (mm)				Constant e	Axial Load Factors			Mass (kg) approx.
	D	B ₂	C	r _{min.}	r _{1 min.}	C _r	C _{0r}	Grease	Oil		d _{a min.}	D _{b min.}	r _{a max.}	r _{b max.}		Y ₂	Y ₃	Y ₀	
40	80	45	37.5	1.5	0.6	109 000	140 000	3 700	5 100	HR 40 KBE 42+L	51	75	1.5	0.6	0.37	2.7	1.8	1.8	0.97
	85	47	37.5	1.5	0.6	117 000	159 000	3 400	4 700		HR 45 KBE 42+L	56	81	1.5	0.6	0.40	2.5	1.7	1.6
45	85	55	43.5	1.5	0.6	143 000	204 000	3 400	4 700	HR 45 KBE 52X+L	56	81	1.5	0.6	0.40	2.5	1.7	1.6	1.31
	90	48	38.5	1.5	0.6	131 000	183 000	3 200	4 400	HR 50 KBE 042+L	61	87	1.5	0.6	0.42	2.4	1.6	1.6	1.20
50	90	49	39.5	1.5	0.6	131 000	183 000	3 200	4 400	HR 50 KBE 42+L	61	87	1.5	0.6	0.42	2.4	1.6	1.6	1.22
	90	55	43.5	1.5	0.6	150 000	218 000	3 200	4 400	HR 50 KBE 52X+L	61	87	1.5	0.6	0.42	2.4	1.6	1.6	1.39
	110	64	51.5	2.5	0.6	224 000	297 000	2 700	3 700	HR 50 KBE 043+L	65	104	2	0.6	0.35	2.9	2.0	1.9	2.77
	110	64	51.5	2.5	0.6	224 000	297 000	2 700	3 700	HR 50 KBE 043+L	65	104	2	0.6	0.35	2.9	2.0	1.9	2.77
55	100	51	41.5	2	0.6	162 000	226 000	2 900	3 900	HR 55 KBE 042+L	67	96	2	0.6	0.40	2.5	1.7	1.6	1.59
	100	52	42.5	2	0.6	162 000	226 000	2 900	3 900	HR 55 KBE 1003+L	67	96	2	0.6	0.40	2.5	1.7	1.6	1.63
	100	60	48.5	2	0.6	188 000	274 000	2 900	3 900	HR 55 KBE 52X+L	67	97	2	0.6	0.40	2.5	1.7	1.6	1.88
	120	70	57	2.5	0.6	256 000	342 000	2 500	3 400	HR 55 KBE 43+L	70	113	2	0.6	0.35	2.9	2.0	1.9	3.52
60	110	53	43.5	2	0.6	178 000	246 000	2 700	3 600	HR 60 KBE 042+L	72	105	2	0.6	0.40	2.5	1.7	1.6	2.03
	110	66	54.5	2	0.6	225 000	335 000	2 700	3 600	HR 60 KBE 52X+L	72	106	2	0.6	0.40	2.5	1.7	1.6	2.52
	130	74	59	3	1	298 000	405 000	2 300	3 200	HR 60 KBE 43+L	78	122	2.5	1	0.35	2.9	2.0	1.9	4.40
65	120	56	46.5	2	0.6	210 000	300 000	2 400	3 200	HR 65 KBE 42+L	77	115	2	0.6	0.40	2.5	1.7	1.6	2.58
	120	57	47.5	2	0.6	210 000	300 000	2 400	3 200	HR 65 KBE 1202+L	77	115	2	0.6	0.40	2.5	1.7	1.6	2.61
	120	73	61.5	2	0.6	269 000	405 000	2 400	3 300	HR 65 KBE 52X+L	77	117	2	0.6	0.40	2.5	1.7	1.6	3.35
	140	79	63	3	1	340 000	465 000	2 100	2 900	HR 65 KBE 43+L	83	132	2.5	1	0.35	2.9	2.0	1.9	5.42
70	125	57	46.5	2	0.6	227 000	325 000	2 300	3 100	HR 70 KBE 042+L	82	120	2	0.6	0.42	2.4	1.6	1.6	2.79
	125	59	48.5	2	0.6	227 000	325 000	2 300	3 100	HR 70 KBE 42+L	82	120	2	0.6	0.42	2.4	1.6	1.6	2.85
	125	74	61.5	2	0.6	270 000	410 000	2 300	3 100	HR 70 KBE 52X+L	82	121	2	0.6	0.42	2.4	1.6	1.6	3.58
	150	83	67	3	1	390 000	535 000	2 000	2 700	HR 70 KBE 43+L	88	142	2.5	1	0.35	2.9	2.0	1.9	6.45
75	130	62	51.5	2	0.6	245 000	365 000	2 200	3 000	HR 75 KBE 42+L	87	126	2	0.6	0.44	2.3	1.6	1.5	3.15
	130	74	61.5	2	0.6	283 000	440 000	2 200	3 000	HR 75 KBE 52X+L	87	127	2	0.6	0.44	2.3	1.6	1.5	3.73
	160	87	69	3	1	435 000	600 000	1 900	2 500	HR 75 KBE 043+L	93	151	2.5	1	0.35	2.9	2.0	1.9	7.66
80	140	61	49	2.5	0.6	269 000	390 000	2 000	2 800	HR 80 KBE 042+L	95	134	2	0.6	0.42	2.4	1.6	1.6	3.70
	140	64	51.5	2.5	0.6	269 000	390 000	2 000	2 800	HR 80 KBE 42+L	95	134	2	0.6	0.42	2.4	1.6	1.6	3.70
	140	78	63.5	2.5	0.6	330 000	505 000	2 000	2 800	HR 80 KBE 52X+L	95	136	2	0.6	0.42	2.4	1.6	1.6	4.59
	170	92	73	3	1	475 000	655 000	1 700	2 400	HR 80 KBE 043+L	98	161	2.5	1	0.35	2.9	2.0	1.9	9.02
85	150	70	57	2.5	0.6	315 000	465 000	1 900	2 600	HR 85 KBE 42+L	100	143	2	0.6	0.42	2.4	1.6	1.6	4.69
	150	86	69	2.5	0.6	360 000	555 000	1 900	2 600	HR 85 KBE 52X+L	100	144	2	0.6	0.42	2.4	1.6	1.6	5.70
	180	98	77	4	1	530 000	745 000	1 600	2 200	HR 85 KBE 043+L	106	169	3	1	0.35	2.9	2.0	1.9	10.8
90	160	71	58	2.5	0.6	345 000	510 000	1 800	2 400	HR 90 KBE 042+L	105	152	2	0.6	0.42	2.4	1.6	1.6	5.53
	160	74	61	2.5	0.6	345 000	510 000	1 800	2 400	HR 90 KBE 42+L	105	152	2	0.6	0.42	2.4	1.6	1.6	5.71
	160	94	77	2.5	0.6	440 000	700 000	1 800	2 400	HR 90 KBE 52X+L	105	154	2	0.6	0.42	2.4	1.6	1.6	7.26

Remark For other double-row tapered roller bearings not listed above, please contact NSK.

DOUBLE-ROW TAPERED ROLLER BEARINGS

Bore Diameter 90 – 120 mm

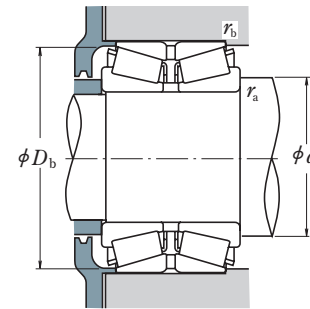
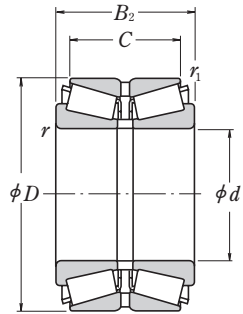

Dynamic Equivalent Load

$$P = XF_r + YF_a$$

$F_a/F_r \leq e$		$F_a/F_r > e$	
X	Y	X	Y
1	Y_3	0.67	Y_2

Static Equivalent Load

$$P_0 = F_r + Y_0 F_a$$

The values of e , Y_2 , Y_3 , and Y_0 are given in the table below.

Boundary Dimensions (mm)						Basic Load Ratings (N)		Limiting Speeds (min ⁻¹)		Bearing Designation	Abutment and Fillet Dimensions (mm)				Constant e	Axial Load Factors			Mass (kg) approx.	
d	D	B_2	C	r min.	r_1 min.	C_r	C_{0r}	Grease	Oil		d_a min.	D_b min.	r_a max.	r_b max.		Y_2	Y_3	Y_0		
90	190	102	81	4	1	595 000	845 000	1 600	2 100	HR 90 KBE 043+L	111	178	3	1	0.35	2.9	2.0	1.9	12.7	
	190	144	115	4	1	770 000	1 180 000	1 600	2 200	HR 90 KBE 1901+L	111	179	3	1	0.35	2.9	2.0	1.9	17.9	
95	170	78	63	3	1	385 000	570 000	1 700	2 300	HR 95 KBE 42+L	113	161	2.5	1	0.42	2.4	1.6	1.6	6.75	
	170	100	83	3	1	495 000	800 000	1 700	2 300	HR 95 KBE 52+L	113	163	2.5	1	0.42	2.4	1.6	1.6	8.60	
	200	108	85	4	1	640 000	910 000	1 500	2 000	HR 95 KBE 43+L	116	187	3	1	0.35	2.9	2.0	1.9	14.7	
100	165	52	46	2.5	0.6	222 000	340 000	1 700	2 300	100 KBE 31+L	115	156	2	0.6	0.33	3.0	2.0	2.0	4.04	
	180	81	64	3	1	435 000	665 000	1 600	2 200	HR100 KBE 1805+L	118	170	2.5	1	0.42	2.4	1.6	1.6	8.16	
	180	81	65	3	1	435 000	665 000	1 600	2 200	HR100 KBE 042+L	118	170	2.5	1	0.42	2.4	1.6	1.6	8.13	
	180	82	66	3	1	435 000	665 000	1 600	2 200	HR100 KBE 1801+L	118	170	2.5	1	0.42	2.4	1.6	1.6	8.22	
	180	83	67	3	1	435 000	665 000	1 600	2 200	HR100 KBE 42+L	118	170	2.5	1	0.42	2.4	1.6	1.6	8.7	
	180	105	85	3	1	555 000	905 000	1 600	2 200	HR100 KBE 1802+L	118	173	2.5	1	0.42	2.4	1.6	1.6	10.6	
	180	107	87	3	1	555 000	905 000	1 600	2 200	HR100 KBE 52X+L	118	173	2.5	1	0.42	2.4	1.6	1.6	10.7	
	180	110	90	3	1	555 000	905 000	1 600	2 200	HR100 KBE 1804+L	118	173	2.5	1	0.42	2.4	1.6	1.6	11	
	215	112	87	4	1	725 000	1 050 000	1 400	1 900	HR100 KBE 043+L	121	200	3	1	0.35	2.9	2.0	1.9	18.1	
	105	190	88	70	3	1	480 000	735 000	1 500	2 000	HR105 KBE 42X+L	123	179	2.5	1	0.42	2.4	1.6	1.6	9.76
190		117	96	3	1	620 000	1 020 000	1 500	2 000	HR105 KBE 1902+L	123	182	2.5	1	0.42	2.4	1.6	1.6	13.4	
190		115	95	3	1	620 000	1 020 000	1 500	2 000	HR105 KBE 52+L	123	182	2.5	1	0.42	2.4	1.6	1.6	13.1	
225		116	91	4	1	780 000	1 130 000	1 300	1 800	HR105 KBE 043+L	126	209	3	1	0.35	2.9	2.0	1.9	20.4	
110		180	56	50	2.5	0.6	264 000	400 000	1 500	2 000	110 KBE 31+L	125	172	2	0.6	0.39	2.6	1.7	1.7	5.11
	180	70	56	2.5	0.6	340 000	555 000	1 500	2 000	110 KBE 031+L	125	172	2	0.6	0.39	2.6	1.7	1.7	6.33	
	180	125	100	2.5	0.6	550 000	1 060 000	1 500	2 100	110 KBE 1802+L	125	172	2	0.6	0.26	3.8	2.6	2.5	11.4	
	200	90	72	3	1	540 000	840 000	1 400	1 900	HR110 KBE 42+L	128	190	2.5	1	0.42	2.4	1.6	1.6	11.2	
	200	92	74	3	1	540 000	840 000	1 400	1 900	HR110 KBE 42X+L	128	190	2.5	1	0.42	2.4	1.6	1.6	11.5	
	200	120	100	3	1	685 000	1 130 000	1 400	1 900	HR110 KBE 2001+L	128	193	2.5	1	0.42	2.4	1.6	1.6	15.4	
	200	121	101	3	1	685 000	1 130 000	1 400	1 900	HR110 KBE 52X+L	128	193	2.5	1	0.42	2.4	1.6	1.6	15.2	
	240	118	93	4	1.5	830 000	1 190 000	1 200	1 700	HR110 KBE 043+L	131	223	3	1.5	0.35	2.9	2.0	1.9	23.6	
	120	180	46	41	2.5	0.6	184 000	296 000	1 500	2 000	120 KBE 30+L	135	172	2	0.6	0.40	2.5	1.7	1.6	3.75
		180	58	46	2.5	0.6	260 000	450 000	1 500	2 000	120 KBE 030+L	135	172	2	0.6	0.39	2.6	1.7	1.7	4.64
200		62	55	2.5	0.6	310 000	500 000	1 400	1 800	120 KBE 31+L	135	190	2	0.6	0.39	2.6	1.7	1.7	7.35	
200		78	62	2.5	0.6	415 000	690 000	1 400	1 900	120 KBE 031+L	135	190	2	0.6	0.39	2.6	1.7	1.7	8.97	
200		100	84	2.5	0.6	515 000	885 000	1 400	1 800	120 KBE 2001+L	135	193	2	0.6	0.37	2.7	1.8	1.8	11.3	
215		97	78	3	1	575 000	900 000	1 300	1 800	HR120 KBE 42X+L	138	204	2.5	1	0.44	2.3	1.6	1.5	13.7	
215		132	109	3	1	750 000	1 270 000	1 300	1 800	HR120 KBE 52X+L	138	207	2.5	1	0.44	2.3	1.6	1.5	18.8	
260		128	101	4	1	915 000	1 310 000	1 100	1 500	HR120 KBE 43+L	141	240	3	1	0.35	2.9	2.0	1.9	29.4	
260		188	145	4	1	1 320 000	2 110 000	1 100	1 500	HR120 KBE 2601+L	141	242	3	1	0.35	2.9	2.0	1.9	44.6	

Remark For other double-row tapered roller bearings not listed above, please contact NSK.

DOUBLE-ROW TAPERED ROLLER BEARINGS

Bore Diameter 125 – 150 mm

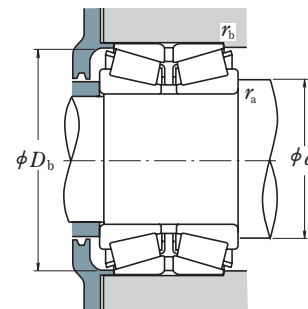
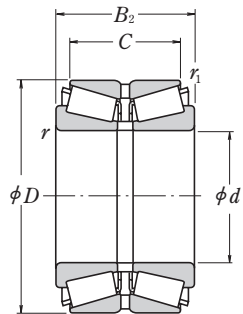

Dynamic Equivalent Load

$$P = XF_r + YF_a$$

$F_a/F_r \leq e$		$F_a/F_r > e$	
X	Y	X	Y
1	Y_3	0.67	Y_2

Static Equivalent Load

$$P_0 = F_r + Y_0 F_a$$

The values of e , Y_2 , Y_3 , and Y_0 are given in the table below.

d	Boundary Dimensions (mm)					Basic Load Ratings (N)		Limiting Speeds (min ⁻¹)		Bearing Designation	Abutment and Fillet Dimensions (mm)				Constant e	Axial Load Factors			Mass (kg)
	D	B ₂	C	r _{min.}	r _{1 min.}	C _r	C _{0r}	Grease	Oil		d _{a min.}	D _{b min.}	r _{a max.}	r _{b max.}		Y ₂	Y ₃	Y ₀	
125	210	110	88	4	1	560 000	1 030 000	1 300	1 800	125 KBE 2101+L	146	201	3	1	0.43	2.3	1.6	1.5	14.5
130	230	98	78.5	4	1	640 000	1 010 000	1 200	1 600	HR130 KBE 42+L	151	220	3	1	0.44	2.3	1.6	1.5	15.8
	230	100	80.5	4	1	640 000	1 010 000	1 200	1 600	HR130 KBE 2301+L	151	220	3	1	0.44	2.3	1.6	1.5	15.9
	280	137	107.5	5	1.5	940 000	1 350 000	1 000	1 400	130 KBE 43+L	157	258	4	1.5	0.36	2.8	1.9	1.8	35
130	230	145	115	4	1	905 000	1 580 000	1 200	1 700	HR130 KBE 2302+L	151	221	3	1	0.44	2.3	1.6	1.5	24.1
	230	145	117.5	4	1	905 000	1 580 000	1 200	1 700	HR130 KBE 52+L	151	222	3	1	0.44	2.3	1.6	1.5	23.8
	230	150	120	4	1	905 000	1 580 000	1 200	1 700	HR130 KBE 2303+L	151	221	3	1	0.44	2.3	1.6	1.5	24.2
140	210	53	47	2.5	0.6	282 000	495 000	1 200	1 700	140 KBE 30+L	155	202	2	0.6	0.39	2.6	1.7	1.7	6.02
	210	66	53	2.5	1	305 000	530 000	1 200	1 700	140 KBE 030+L	155	202	2	1	0.40	2.5	1.7	1.6	7.02
	210	106	94	2.5	0.6	555 000	1 200 000	1 300	1 700	140 KBE 2101+L	155	202	2	0.6	0.33	3.0	2.0	2.0	12.3
140	225	68	61	3	1	400 000	630 000	1 200	1 600	140 KBE 31+L	158	216	2.5	1	0.39	2.6	1.7	1.7	9.31
	225	84	68	3	1	490 000	850 000	1 200	1 600	140 KBE 031+L	158	215	2.5	1	0.39	2.6	1.7	1.7	11.6
	225	85	68	3	1	490 000	850 000	1 200	1 600	140 KBE 2201+L	158	215	2.5	1	0.39	2.6	1.7	1.7	11.7
140	230	120	94	3	1	685 000	1 270 000	1 200	1 600	140 KBE 2301+L	158	220	2.5	1	0.33	3.0	2.0	2.0	17.6
	230	140	110	3	1	820 000	1 550 000	1 200	1 600	140 KBE 2302+L	158	221	2.5	1	0.35	2.9	2.0	1.9	20.7
	240	132	106	4	1.5	685 000	1 360 000	1 100	1 500	140 KBE 2401+L	161	227	3	1.5	0.44	2.3	1.5	1.5	22.7
140	250	102	82.5	4	1	670 000	1 030 000	1 100	1 500	HR140 KBE 42+L	161	237	3	1	0.44	2.3	1.6	1.5	18.9
	250	153	125.5	4	1	1 040 000	1 830 000	1 100	1 500	HR140 KBE 52X+L	161	241	3	1	0.44	2.3	1.6	1.5	29.6
	300	145	115.5	5	1.5	1 030 000	1 480 000	1 000	1 300	140 KBE 43+L	167	275	4	1.5	0.36	2.8	1.9	1.8	42.6
150	225	56	50	3	1	300 000	545 000	1 200	1 600	150 KBE 30+L	168	213	2.5	1	0.35	2.9	2.0	1.9	7.41
	225	70	56	3	1	395 000	685 000	1 200	1 600	150 KBE 030+L	168	215	2.5	1	0.35	2.9	2.0	1.9	8.70
	250	80	71	3	1	510 000	810 000	1 100	1 400	150 KBE 31+L	168	240	2.5	1	0.40	2.5	1.7	1.6	14.2
150	250	100	80	3	1	630 000	1 090 000	1 100	1 400	150 KBE 031+L	168	238	2.5	1	0.39	2.6	1.7	1.7	17.8
	250	115	95	3	1	745 000	1 320 000	1 100	1 500	150 KBE 2502+L	168	238	2.5	1	0.37	2.7	1.8	1.8	20.9
	260	150	115	4	1	815 000	1 520 000	1 100	1 400	150 KBE 2601+L	171	242	3	1	0.43	2.3	1.6	1.5	30.0
150	270	109	87	4	1	830 000	1 330 000	1 000	1 400	HR150 KBE 42+L	171	253	3	1	0.44	2.3	1.6	1.5	24.3
	270	164	130	4	1	1 210 000	2 150 000	1 000	1 400	HR150 KBE 52X+L	171	257	3	1	0.44	2.3	1.6	1.5	37.3
	270	174	140	4	1	1 210 000	2 150 000	1 000	1 400	HR150 KBE 2701+L	171	257	3	1	0.44	2.3	1.6	1.5	39.7
320	154	120	5	1.5	1 420 000	2 130 000	900	1 200	HR150 KBE 43+L	177	295	4	1.5	0.35	2.9	2.0	1.9	53.4	

Remark For other double-row tapered roller bearings not listed above, please contact NSK.

DOUBLE-ROW TAPERED ROLLER BEARINGS

Bore Diameter 160 – 200 mm

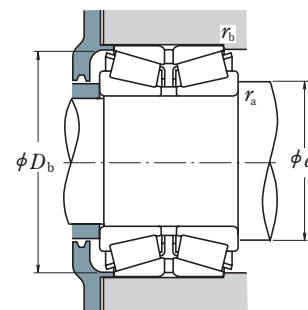
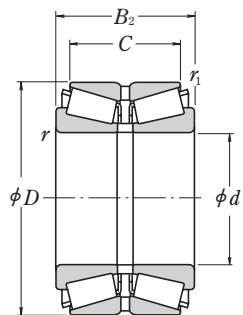

Dynamic Equivalent Load

$$P = XF_r + YF_a$$

$F_a/F_r \leq e$		$F_a/F_r > e$	
X	Y	X	Y
1	Y_3	0.67	Y_2

Static Equivalent Load

$$P_0 = F_r + Y_0 F_a$$

The values of e , Y_2 , Y_3 , and Y_0 are given in the table below.

d	Boundary Dimensions (mm)					Basic Load Ratings (N)		Limiting Speeds (min ⁻¹)		Bearing Designation	Abutment and Fillet Dimensions (mm)				Constant e	Axial Load Factors			Mass (kg) approx.
	D	B ₂	C	r _{min.}	r _{1 min.}	C _r	C _{0r}	Grease	Oil		d _{a min.}	D _{b min.}	r _{a max.}	r _{b max.}		Y ₂	Y ₃	Y ₀	
160	240	60	53	3	1	355 000	580 000	1 100	1 500	160 KBE 30+L	178	231	2.5	1	0.37	2.7	1.8	1.8	8.56
	240	75	60	3	1	395 000	710 000	1 100	1 500	160 KBE 030+L	178	230	2.5	1	0.40	2.5	1.7	1.6	10.5
	240	110	90	3	1	650 000	1 290 000	1 100	1 500	160 KBE 2401+L	178	232	2.5	1	0.38	2.6	1.8	1.7	16.2
	270	86	76	3	1	540 000	885 000	1 000	1 300	160 KBE 31+L	178	255	2.5	1	0.40	2.5	1.7	1.6	18.6
	270	108	86	3	1	775 000	1 380 000	1 000	1 300	160 KBE 031+L	178	256	2.5	1	0.39	2.6	1.7	1.7	23.1
	270	140	120	3	1	990 000	1 880 000	1 000	1 300	160 KBE 2701+L	178	261	2.5	1	0.39	2.6	1.7	1.7	30.6
	280	150	125	4	1	1 100 000	2 020 000	1 000	1 300	160 KBE 2801+L	181	266	3	1	0.32	3.2	2.1	2.1	35.9
	290	115	91	4	1	800 000	1 220 000	900	1 300	160 KBE 42+L	181	275	3	1	0.43	2.3	1.6	1.5	28.2
	290	178	144	4	1	1 360 000	2 440 000	1 000	1 300	HR160 KBE 52X+L	181	277	3	1	0.44	2.3	1.6	1.5	47.3
	340	160	126	5	1.5	1 310 000	1 920 000	800	1 100	160 KBE 43+L	187	314	4	1.5	0.36	2.8	1.9	1.8	60.4
165	290	150	125	4	1	1 140 000	2 130 000	900	1 300	165 KBE 2901+L	186	272	3	1	0.33	3.1	2.1	2.0	39.5
170	250	85	65	3	1	435 000	845 000	1 000	1 400	170 KBE 2501+L	188	241	2.5	1	0.44	2.3	1.5	1.5	12.3
	260	67	60	3	1	400 000	700 000	1 000	1 300	170 KBE 30+L	188	248	2.5	1	0.40	2.5	1.7	1.6	11.8
	260	84	67	3	1	575 000	1 030 000	1 000	1 300	170 KBE 030+L	188	249	2.5	1	0.39	2.6	1.7	1.7	14.4
	280	88	78	3	1	630 000	1 040 000	900	1 300	170 KBE 31+L	188	266	2.5	1	0.39	2.6	1.7	1.7	19.7
	280	110	88	3	1	820 000	1 450 000	900	1 300	170 KBE 031+L	188	268	2.5	1	0.39	2.6	1.7	1.7	24.2
	280	150	130	3	1	1 110 000	2 160 000	1 000	1 300	170 KBE 2802+L	188	269	2.5	1	0.39	2.6	1.7	1.7	34.6
	310	192	152	5	1.5	1 590 000	2 910 000	900	1 200	HR170 KBE 52X+L	197	297	4	1.5	0.44	2.3	1.6	1.5	57.3
	280	74	66	3	1	455 000	810 000	900	1 300	180 KBE 30+L	198	265	2.5	1	0.40	2.5	1.7	1.6	15.4
	280	93	74	3	1	655 000	1 220 000	900	1 200	180 KBE 030+L	198	265	2.5	1	0.35	2.9	2.0	1.9	14.4
	300	96	85	4	1.5	725 000	1 210 000	900	1 200	180 KBE 31+L	201	284	3	1.5	0.39	2.6	1.7	1.7	24.8
180	300	120	96	4	1.5	940 000	1 690 000	900	1 200	180 KBE 031+L	201	287	3	1.5	0.39	2.6	1.7	1.7	31.1
	320	127	99	5	1.5	895 000	1 390 000	800	1 200	180 KBE 42+L	207	300	4	1.5	0.44	2.3	1.5	1.5	36.5
	320	192	152	5	1.5	1 640 000	3 050 000	900	1 200	HR180 KBE 52X+L	207	308	4	1.5	0.45	2.2	1.5	1.5	59.2
	340	180	140	5	1.5	1 410 000	2 510 000	800	1 100	180 KBE 3401+L	207	305	4	1.5	0.43	2.3	1.6	1.5	68.1
	290	75	67	3	1	490 000	845 000	900	1 200	190 KBE 30+L	208	279	2.5	1	0.39	2.6	1.7	1.7	16.2
	290	94	75	3	1	670 000	1 230 000	900	1 200	190 KBE 030+L	208	279	2.5	1	0.40	2.5	1.7	1.6	20.1
	320	104	92	4	1.5	800 000	1 380 000	800	1 100	190 KBE 31+L	211	301	3	1.5	0.40	2.5	1.7	1.6	30.9
	320	130	104	4	1.5	1 070 000	1 960 000	800	1 100	190 KBE 031+L	211	302	3	1.5	0.39	2.6	1.7	1.7	39.0
	340	133	105	5	1.5	990 000	1 580 000	800	1 100	190 KBE 42+L	217	320	4	1.5	0.40	2.5	1.7	1.6	43.9
	340	204	160	5	1.5	1 910 000	3 550 000	800	1 100	HR190 KBE 52X+L	217	327	4	1.5	0.44	2.3	1.6	1.5	70.8
200	310	152	123	3	1	1 300 000	2 740 000	800	1 100	HR200 KBE 3101+L	218	301	2.5	1	0.43	2.3	1.6	1.5	40.1
	320	146	110	5	1.5	990 000	2 120 000	800	1 100	200 KBE 3201+L	227	301	4	1.5	0.52	1.9	1.3	1.3	41.6
	330	180	140	5	1.5	1 390 000	2 730 000	800	1 100	200 KBE 3301+L	227	316	4	1.5	0.42	2.4	1.6	1.6	54.4
	340	112	100	4	1.5	940 000	1 670 000	800	1 000	200 KBE 31+L	221	321	3	1.5	0.40	2.5	1.7	1.6	38.8
	340	140	112	4	1.5	1 260 000	2 250 000	800	1 000	200 KBE 031+L	221	324	3	1.5	0.39	2.6	1.7	1.7	47.0
	360	142	110	5	1.5	1 100 000	1 780 000	700	1 000	200 KBE 42+L	227	338	4	1.5	0.40	2.5	1.7	1.6	52.6
	360	218	174	5	1.5	2 070 000	3 850 000	800	1 000	HR200 KBE 52+L	227	344	4	1.5	0.41	2.5	1.7	1.6	88.3

Remark For other double-row tapered roller bearings not listed above, please contact NSK.

DOUBLE-ROW TAPERED ROLLER BEARINGS

Bore Diameter 206 – 260 mm

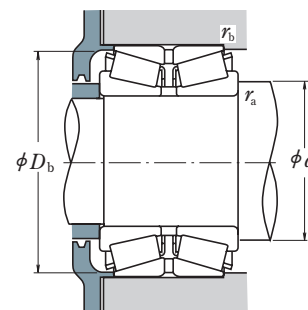
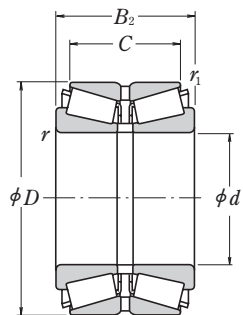

Dynamic Equivalent Load

$$P = XF_r + YF_a$$

$F_a/F_r \leq e$		$F_a/F_r > e$	
X	Y	X	Y
1	Y_3	0.67	Y_2

Static Equivalent Load

$$P_0 = F_r + Y_0 F_a$$

The values of e , Y_2 , Y_3 , and Y_0 are given in the table below.

d	Boundary Dimensions (mm)					Basic Load Ratings (N)		Limiting Speeds (min ⁻¹)		Bearing Designation	Abutment and Fillet Dimensions (mm)				Constant e	Axial Load Factors			Mass (kg)
	D	B ₂	C	r _{min.}	r _{1 min.}	C _r	C _{0r}	Grease	Oil		d _{a min.}	D _{b min.}	r _{a max.}	r _{b max.}		Y ₂	Y ₃	Y ₀	
206	283	102	83	4	1.5	580 000	1 430 000	900	1 200	206 KBE 2801+L	227	275	3	1.5	0.51	2.0	1.3	1.3	18.1
210	355	116	103	4	1.5	905 000	1 520 000	700	1 000	210 KBE 31+L	231	338	3	1.5	0.46	2.2	1.5	1.4	41.7
220	300	110	88	3	1	730 000	1 710 000	800	1 100	220 KBE 3001+L	238	292	2.5	1	0.37	2.7	1.8	1.8	21.2
	340	90	80	4	1.5	695 000	1 280 000	700	1 000	220 KBE 30+L	241	324	3	1.5	0.40	2.5	1.7	1.6	27.9
	340	113	90	4	1.5	920 000	1 830 000	700	1 000	220 KBE 030+L	241	327	3	1.5	0.40	2.5	1.7	1.6	34.7
240	370	120	107	5	1.5	1 110 000	1 940 000	700	1 000	220 KBE 31+L	247	345	4	1.5	0.39	2.6	1.7	1.7	48.3
	370	150	120	5	1.5	1 460 000	2 760 000	700	1 000	220 KBE 031+L	247	349	4	1.5	0.39	2.6	1.7	1.7	60.2
	400	158	122	5	1.5	1 390 000	2 300 000	600	900	220 KBE 42+L	247	371	4	1.5	0.40	2.5	1.7	1.6	74.2
	360	92	82	4	1.5	780 000	1 490 000	700	900	240 KBE 30+L	261	344	3	1.5	0.39	2.6	1.7	1.7	30.1
250	360	115	92	4	1.5	1 020 000	2 040 000	700	900	240 KBE 030+L	261	344	3	1.5	0.35	2.9	2.0	1.9	37.3
	400	128	114	5	1.5	1 180 000	2 190 000	600	900	240 KBE 31+L	267	380	4	1.5	0.43	2.3	1.6	1.5	60.0
	400	160	128	5	1.5	1 620 000	3 050 000	600	900	240 KBE 031+L	267	378	4	1.5	0.39	2.6	1.7	1.7	73.6
	400	209	168	5	1.5	2 220 000	4 450 000	600	900	240 KBE 4003+L	267	384	4	1.5	0.33	3.0	2.0	2.0	96.4
260	380	98	87	4	1	795 000	1 460 000	600	900	250 KBE 3801+L	271	365	3	1	0.40	2.5	1.7	1.6	35.5
260	400	104	92	5	1.5	895 000	1 670 000	600	800	260 KBE 30+L	287	379	4	1.5	0.40	2.5	1.7	1.6	43.4
	400	130	104	5	1.5	1 210 000	2 460 000	600	800	260 KBE 030+L	287	382	4	1.5	0.40	2.5	1.7	1.6	54.1
	440	144	128	5	1.5	1 540 000	2 760 000	600	800	260 KBE 31+L	287	416	4	1.5	0.39	2.6	1.7	1.7	82.5
	440	172	145	5	1.5	1 870 000	3 500 000	600	800	260 KBE 4401+L	287	414	4	1.5	0.38	2.6	1.8	1.7	98.1
	440	180	144	5	1.5	2 110 000	4 150 000	600	800	260 KBE 031+L	287	416	4	1.5	0.39	2.6	1.7	1.7	104.0

Remark For other double-row tapered roller bearings not listed above, please contact NSK.

7. SPHERICAL ROLLER BEARINGS

INTRODUCTION C 258

TECHNICAL DATA

Free Space of Spherical Roller Bearings C 260

Measuring Bearing Clearance C 262

BEARING TABLES

**Spherical Roller Bearings
Cylindrical Bores, Tapered Bores**

Bore Diameter 20 – 1400 mm C 266



DESIGN, TYPES, AND FEATURES

Various types of high load capacity spherical roller bearings are available. Types EA, C and CD have pressed-steel cages, and type CA has machined-brass cages. EA-type bearings listed here are classified as NSKHPS™ bearings, which offer particularly high load-carrying capacity, high limiting speeds, and superior performance under high-temperature operating conditions up to 200 °C.

An oil groove and holes are located in the outer ring to supply lubricant, and the bearing numbers are suffixed with E4.

To use bearings with oil grooves and holes, an oil groove should be located in the housing bore since depth for the groove in the bearing is limited. The dimensions of the oil groove and number of holes present are listed in Tables 1 and 2.

When bearings with a hole for a locking pin to prevent outer ring rotation are required, please contact NSK.

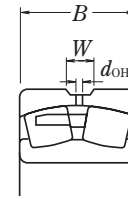
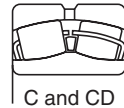
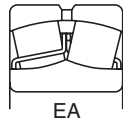

Table 1 Dimensions of Oil Grooves and Holes

Nominal Width B		Units : mm	
over	incl.	Oil Groove Width W	Hole Diameter d _{OH}
18	30	5	2.5
30	40	6	3
40	50	7	4
50	65	8	5
65	80	10	6
80	100	12	8
100	120	15	10
120	160	20	12
160	200	25	15
200	250	30	20
250	315	35	20
315	400	40	25
400	—	40	25

Table 2 Number of Oil Holes

Nominal Outer Ring Dia D (mm)		Number of Holes
over	incl.	
—	180	4
180	250	6
250	315	6
315	400	6
400	500	6
500	630	8
630	800	8
800	1000	8
1000	1250	8
1250	1600	8
1600	2000	8

NSKHPS™ Spherical Roller Bearings

Features Compared with conventional bearings:

Bearing Life
Up to
2
times longer

Working temp.
up to
200 °C

- Improved reliability
Bearing life is up to twice that of conventional bearings thanks to optimization of the bearing's internal design and improvement of processing technology.
- High-temperature dimensional stabilizing treatment comes standard
Dimensional stabilization up to 200 °C has been achieved through the application of NSK's proprietary heat treatment technology.

Formulation of Bearing Designations

Spherical Roller Bearings

Example:

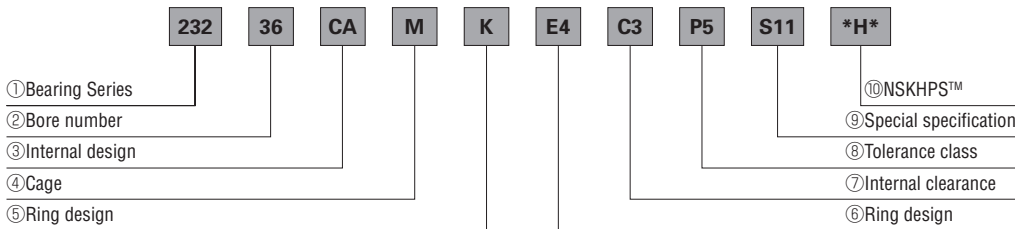

- ① Bearing Series 239, 230, 240, 231, 241, 222, 232, 213, 223 : Spherical roller bearings
- ② Bore number Bore number indicates bore diameter. Bore number X 5 (mm)
- ③ Internal design EA, CA : High load capacity
- ④ Cage M : Machined-brass cage (for CA Design)
Omitted: Pressed-steel cage (for EA Design)
- ⑤⑥ Ring design K : Tapered bore of inner ring (taper 1 : 12)
K30 : Tapered bore of inner ring (taper 1 : 30)
E4 : Lubricating groove in outside surface and holes in outer ring
- ⑦ Internal clearance Omitted : CN clearance, C3 : Clearance greater than CN,
C4 : Clearance greater than C3, C5 : Clearance greater than C4
- ⑧ Tolerance class Omitted : ISO Normal, P6 : ISO Class 6, P5 : ISO Class 5, P4 : ISO Class 4
- ⑨ Special specification S11 ; Dimensional stabilizing treatment: working temperature under 200 °C (omitted for EA design)
- ⑩ NSKHPS™ *H* : NSKHPS™ designation
Tolerance Class : ISO Normal

TOLERANCES AND RUNNING ACCURACY

SPHERICAL ROLLER BEARINGS..... Table 7.2 (Pages A128 to A131)
NSKHPS SPHERICAL ROLLER BEARINGS
Tolerance for Dimensions: ISO Normal
Running Accuracy: ISO Normal

RECOMMENDED FITS

SPHERICAL ROLLER BEARINGS..... Table 8.3 (Page A164)
Table 8.5 (Page A165)

INTERNAL CLEARANCES

SPHERICAL ROLLER BEARINGS..... Table 8.16 (Page A172)

NSKHPS SPHERICAL ROLLER BEARINGS
INTERNAL CLEARANCE DESIGNATION : CN, C3, C4

PERMISSIBLE MISALIGNMENT

The permissible misalignment of spherical roller bearings varies depending on bearing size and load but is approximately 0.018 to 0.045 radian (1° to 2.5°) with normal loads.

LIMITING SPEEDS (GREASE)

The limiting speeds (grease) listed in the bearing tables should be adjusted depending on the bearing load condition. Furthermore, higher speeds are attainable by making changes in the lubrication method, cage design, etc. Refer to Page A098 for detailed information.

PRECAUTIONS FOR USE OF SPHERICAL ROLLER BEARINGS

If the load on spherical roller bearings becomes too small during operation or if, the ratio of axial and radial loads is larger than the value of 'e' as listed in the bearing tables, slippage occurs between the rollers and raceways, which may result in smearing. The higher the weight, the higher this tendency becomes, especially for large spherical roller bearings.

If very small bearing loads are expected, please contact NSK for selection of an appropriate bearing.

SPHERICAL ROLLER BEARINGS**TECHNICAL DATA****Free Space of Spherical Roller Bearings**

Spherical roller bearings have self-aligning capabilities and the capacity to carry substantially large radial and bi-axial loads. For these reasons, this bearing is used widely in many applications, such as plunger blocks. Application problems include a long span, which causes substantial deflection of the shaft, installation errors, and axial misalignment. These bearings may be exposed to large radial or shock loads.

Grease lubrication is common for spherical roller bearings because it simplifies the seal construction around the housing and makes maintenance and inspection easier. In this case, it is important to select a grease appropriate to the operating conditions and to fill the bearing with the proper amount of grease while considering the housing internal space.

The amount of bearing free space for various spherical roller bearings is shown in Table 1. Under general operating conditions, a user may pack up to 1/3 to 2/3 of the free space of the bearing with grease.

Table 1 Free Space of Spherical Roller Bearings (EA, C, CD, and CA)Units: cm³

Bearing Bore No.	Bearing Free Space				
	Bearing Series				
	230	231	222	232	223
11	—	—	29	—	78
12	—	—	42	—	96
13	—	—	48	—	113
14	—	—	52	—	139
15	—	—	57	—	170
16	—	—	71	—	206
17	—	—	91	—	234
18	—	—	110	130	283
19	—	—	135	—	327
20	—	—	169	203	410
22	100	150	242	294	560
24	109	228	297	340	700
26	161	240	365	405	955
28	170	292	400	530	1 230
30	209	465	505	680	1 430
32	254	575	680	850	1 710
34	355	610	785	1 090	2 070
36	465	785	810	1 120	2 460
38	565	970	1 160	1 340	2 830
40	715	1 160	1 400	1 640	2 900
44	940	1 500	1 880	2 270	3 750
48	1 030	1 900	2 550	3 550	4 700
52	1 530	2 940	3 300	4 750	5 900
56	1 820	3 150	3 400	4 950	7 250
60	2 200	4 050	4 300	6 200	8 750

Remarks 22211 to 22226 and 22311 to 22324 are EA bearings.
23122 to 23148 and 23218 to 23244 are C bearings.
23022 to 23036 and 22228 to 22236 are CD bearings.
23038 to 23060, 23152 to 23160, 22238 to 22260,
23248 to 23260, and 22326 to 22360 are CA bearings.

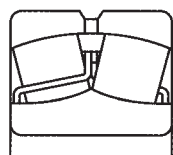

EA type

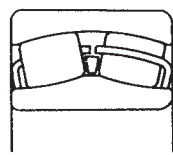

C, CD type

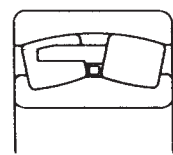

CA type

Measurement of Clearance in SRBs

The measurement of internal bearing clearance before mounting is critical. Before handling the bearing and measuring the internal bearing clearance, be sure to wear thin rubber gloves.

If bearings are touched with bare hands, the touched part may rust.

When measuring the internal bearing clearance, ensure that the rollers are positioned correctly.

1. Measurement of Bearing Clearance

To measure only internal bearing clearance, set the bearing upright (vertically) on a flat surface while holding the outer ring with one hand. Take care not to incline the inner and outer rings, and stabilize the rollers by turning the inner ring clockwise and counter-clockwise by about one half to one full rotation. Adjust the rollers until a random roller is positioned at the very top of the bearing. Next, use a thickness gauge to measure the internal clearance. Measurement positioning and location may vary slightly depending on the size of the outer ring outside diameter.

1.1 When Bearing Outside Diameter Is Under 200 mm

Insert the thickness gauge between the two rows of rollers and the outer ring at the rollers located at the very top of the bearing. Then, measure the internal clearance Δ_r (see Fig. 1).

1.2 When Bearing Outside Diameter Is Over 200 mm

Insert the thickness gauge between the two rows of rollers and the outer ring at the very top of the bearing and on the sides at two symmetrical points relative to the bearing center. Then, take respective measurements for the bearing internal clearance (see Fig. 2).

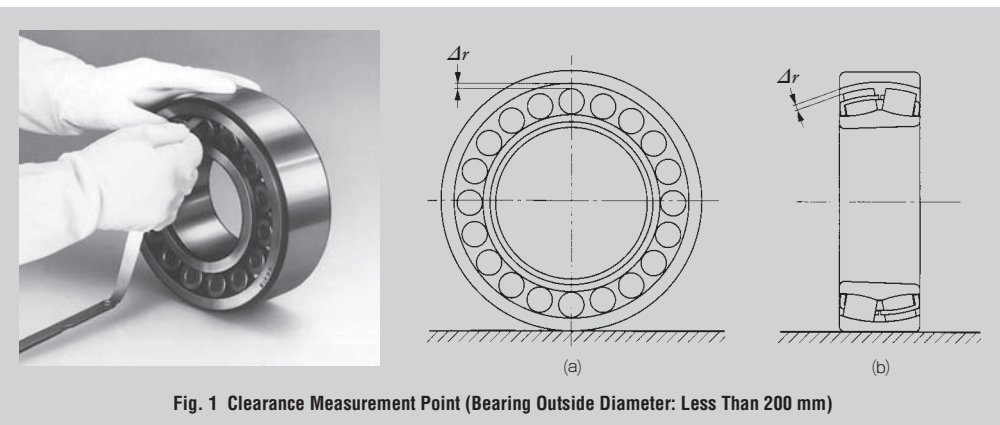

Fig. 1 Clearance Measurement Point (Bearing Outside Diameter: Less Than 200 mm)

Take the individual values measured at the very top of bearing and outer ring as Δ_{rT1} and Δ_{rT2} , and determine the internal clearance at the top of the bearing Δ_{rT} by the following equation:

$$\Delta_{rT} = 1/2 (\Delta_{rT1} + \Delta_{rT2})$$

Then, take the measurements between the two rows of rollers on the left side as Δ_{rL1} and Δ_{rL2} , and determine the internal clearance on the left side of the bearing Δ_{rL} by the following equation:

$$\Delta_{rL} = 1/2 (\Delta_{rL1} + \Delta_{rL2})$$

Next, take the measurements between the two rows of rollers on the right side as Δ_{rR1} and Δ_{rR2} , and determine the internal clearance on the right side of the bearing Δ_{rR} by the following equation:

$$\Delta_{rR} = 1/2 (\Delta_{rR1} + \Delta_{rR2})$$

Finally, determine the internal bearing clearance Δ_r by the following equation:

$$\Delta_r = 1/2 (\Delta_{rT} + \Delta_{rL} + \Delta_{rR})$$

2. Measuring Bearing Clearance When Mounted on Shaft or Sleeve

In this case, clearance measurements are taken with the outer ring of the bearing hanging down from the rollers. First, while holding the bearing upright, rotate the outer ring clockwise and counter-clockwise by one-half to one full rotation until both rows have a random roller positioned exactly at the bottom. Use a thickness gauge to measure the clearance at the designated measuring points.

The measurement points vary slightly depending on the size of the outer ring outside diameter.

2.1 When Bearing Outside Diameter is Under 200 mm

Insert the thickness gauge between the two rows of rollers and outer ring at the very bottom of the bearing, and measure the internal clearance Δ_{rS} (Fig. 3).

2.2 When Bearing Outside Diameter Is Over 200 mm

Insert the thickness gauge between the two rows of rollers and the outer ring at the very bottom of the bearing and on the sides at two symmetrical points relative to the bearing center. Then, take respective measurements for the bearing internal clearance Δ_r (Fig. 3). Because the bearing has two rows, two measurements of bearing internal clearance should be taken as Δ_{rS1} and Δ_{rS2} , and the internal clearance at the very bottom of the bearing Δ_{rS} should be determined by the following equation:

$$\Delta_{rS} = 1/2 (\Delta_{rS1} + \Delta_{rS2})$$

Then, take the individual values on the left side as

Δ_{rL1} and Δ_{rL2} , and determine the internal clearance on the left side of bearing Δ_{rL} by the following equation:

$$\Delta_{rL} = 1/2 (\Delta_{rL1} + \Delta_{rL2})$$

Next, take the individual values on the right side as Δ_{rR1} and Δ_{rR2} , and determine the internal clearance on the right side of bearing Δ_{rR} by the following equation:

$$\Delta_{rR} = 1/2 (\Delta_{rR1} + \Delta_{rR2})$$

Finally, determine internal bearing clearance (Δ_r) by the following equation:

$$\Delta_r = 1/2 (\Delta_{rS} + \Delta_{rL} + \Delta_{rR})$$

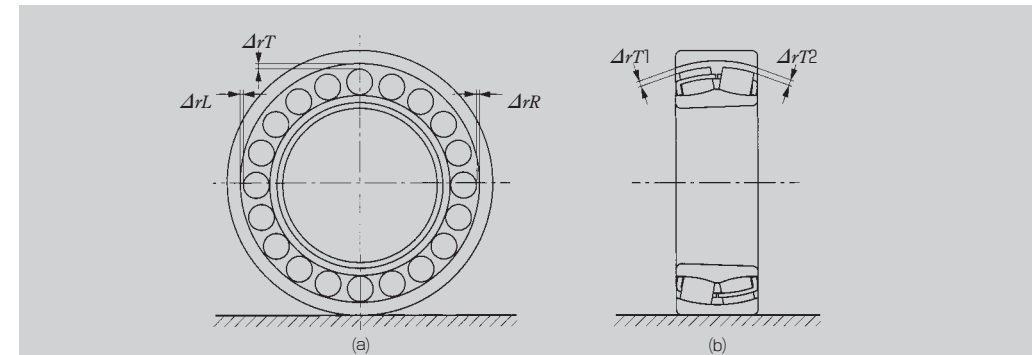

Fig. 2 Clearance Measurement Points (Bearing Outside Diameter: Larger Than 200 mm)

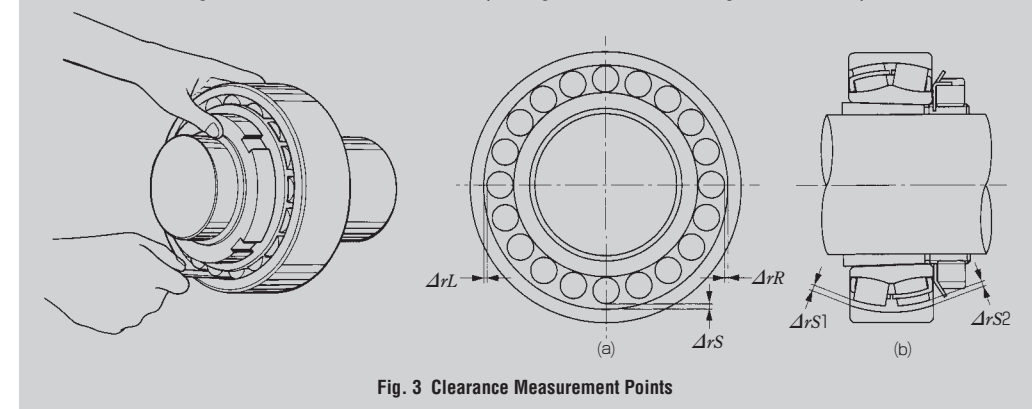

Fig. 3 Clearance Measurement Points

SPHERICAL ROLLER BEARINGS

3. Temperature Equilibrium When Taking Measurements

To ensure accurate bearing measurements, the temperature of the measurement instrument and components to be measured must be the same. If the bearing is mounted with an oil heating tank or induction heater, be sure to measure the internal clearance only after a complete cooldown. If a bearing is brought from a warehouse to the measurement area, the temperature of the bearing may still be high; thus, if clearance or dimensions were measured without confirming bearing temperature, the measured value may be wrong.

For a large bearing with an outer ring outside diameter larger than 400 mm, the unpacked bearing should be left on a surface plate for about 24 hours before making a clearance or dimensional measurement. Put the end face of the bearing on a surface plate prior to measurement to ensure both objects have the same temperature.

4. Clearance Adjustment When Mounting a Bearing on a Tapered Shaft or Sleeve

When mounting a bearing with a tapered bore to a tapered shaft or sleeve (adapter or removable sleeve), the inner ring of the bearing will widen and interference will increase when pushing in the bearing, resulting in reduced internal clearance depending on the taper. Be sure to provide proper interference and internal clearance when mounting the bearing. See Table 2 for the clearance reduction amounts when mounting spherical roller bearings with tapered bores.

Each time the bearing is pushed further onto the tapered shaft or sleeve, measure the variation of the internal clearance and repeat the above procedure until the clearance reduction amount specified in Table 2 is attained. This procedure is called "clearance adjustment," and when the proper reduction amount is attained, the clearance necessary for operation is secured. The clearance reduction amount must be confirmed by a thickness gauge; however, depending on the method of clearance adjustment, the measured value obtained with the thickness gauge may not be correct. Therefore, execute the following corrective procedures:

1. When using heat:
When the bearing and shaft are both at room temperature, measure the clearance again with a thickness gauge to confirm that the specified value is secured.
2. When using a lockwasher as a turning stopper for the locknut:
Prior to bending the tooth of the lockwasher into the cutout for the locknut, measure the clearance with the thickness gauge again to confirm that the specified value is secured.
3. When using a hydraulic nut:

After removal of the hydraulic nut, mount the locknut and measure the clearance again to confirm that the specified value remains constant prior to stopping turning.

4. When using an oil injection pump:
Drop the pressure of the oil fed from the oil injection pump to zero so that there is no pressure on the bearing or fitted part of the sleeve. Next, measure the clearance with a thickness gauge to confirm that the specified value remains secured.

Radial Internal Clearance and Clearance Reduction Amount for the Bearing to be Mounted

- When radial internal clearance is CN (normal clearance):
Perform the clearance adjustment by aiming for a middle value between the minimum and maximum clearance reduction amounts.
- When radial internal clearance is C3 or C4:
Perform the clearance adjustment by aiming for the maximum clearance reduction amount.

Internal Clearance Adjustment of Tapered Bore Bearings

Perform the adjustment by measuring the clearance reduction amount with a thickness gauge.

1. For measurement location and positioning, refer to Section 2 (Page C262) of this catalog.
2. When mounting a bearing on a tapered shaft, perform a clearance adjustment each time the bearing is pushed in by a locknut, end plate, end cap, or hydraulic nut.
3. When using an adapter sleeve, perform a clearance adjustment each time the bearing is pushed in by a locknut or hydraulic nut.
4. When using a removable sleeve, perform an adjustment each time the removable sleeve is pushed in by a locknut or hydraulic nut.

Since the outer ring of the bearing hangs down from the rollers, turn the outer ring clockwise and counterclockwise by onehalf to one full rotation while maintaining the proper bearing position before taking clearance measurements for these operations. Position one randomly chosen roller from each row at the very bottom of the bearing. Then, insert the thickness gauge to measure the internal clearance at the appropriate location(s) based on the size of the outer ring outside diameter. These clearance measurement values should be recorded.

Table 2 Mounting of Spherical Roller Bearings With Tapered Bores

Units : mm

Bore Diameter d (mm)		Reduction in Radial Clearance		Axial Movement				Minimum Permissible Residual Clearance		
				Taper 1 : 12		Taper 1 : 30		CN	C3	C4
over	incl.	min.	max.	min.	max.	min.	max.			
30	40	0.025	0.030	0.40	0.45	—	—	0.010	0.025	0.035
40	50	0.030	0.035	0.45	0.55	—	—	0.015	0.030	0.045
50	65	0.030	0.035	0.45	0.55	—	—	0.025	0.035	0.060
65	80	0.040	0.045	0.60	0.70	—	—	0.030	0.040	0.075
80	100	0.045	0.055	0.70	0.85	1.75	2.15	0.035	0.050	0.085
100	120	0.050	0.060	0.75	0.90	1.9	2.25	0.045	0.065	0.110
120	140	0.060	0.070	0.90	1.1	2.25	2.75	0.055	0.080	0.130
140	160	0.065	0.080	1.0	1.3	2.5	3.25	0.060	0.100	0.150
160	180	0.070	0.090	1.1	1.4	2.75	3.5	0.070	0.110	0.170
180	200	0.080	0.100	1.3	1.6	3.25	4.0	0.070	0.110	0.190
200	225	0.090	0.110	1.4	1.7	3.5	4.25	0.080	0.130	0.210
225	250	0.100	0.120	1.6	1.9	4.0	4.75	0.090	0.140	0.230
250	280	0.110	0.140	1.7	2.2	4.25	5.5	0.100	0.150	0.250
280	315	0.120	0.150	1.9	2.4	4.75	6.0	0.110	0.160	0.280
315	355	0.140	0.170	2.2	2.7	5.5	6.75	0.120	0.180	0.300
355	400	0.150	0.190	2.4	3.0	6.0	7.5	0.130	0.200	0.330
400	450	0.170	0.210	2.7	3.3	6.75	8.25	0.140	0.220	0.360
450	500	0.190	0.240	3.0	3.7	7.5	9.25	0.160	0.240	0.390
500	560	0.210	0.270	3.4	4.3	8.5	11.0	0.170	0.270	0.410
560	630	0.230	0.300	3.7	4.8	9.25	12.0	0.200	0.310	0.460
630	710	0.260	0.330	4.2	5.3	10.5	13.0	0.220	0.330	0.520
710	800	0.280	0.370	4.5	5.9	11.5	15.0	0.240	0.390	0.590
800	900	0.310	0.410	5.0	6.6	12.5	16.5	0.280	0.430	0.660
900	1000	0.340	0.460	5.5	7.4	14.0	18.5	0.310	0.470	0.730
1000	1120	0.370	0.500	5.9	8.0	15.0	20.0	0.360	0.530	0.800

Remarks The values for reduction in radial internal clearance are for bearings with CN clearance. For bearings with C3 or C4 Clearance, the maximum values listed should be used.



SPHERICAL ROLLER BEARINGS

Bore Diameter 20 – 55 mm

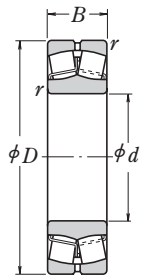

Cylindrical Bore

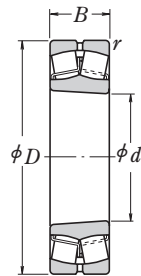

Tapered Bore

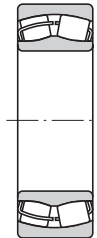

Without an Oil Groove or Holes

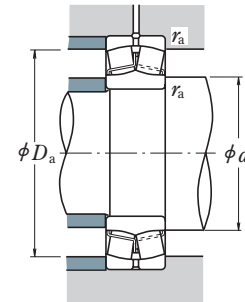

Dynamic Equivalent Load

$$P = XF_r + YF_a$$

$F_a/F_r \leq e$		$F_a/F_r > e$	
X	Y	X	Y
1	Y_3	0.67	Y_2

Static Equivalent Load

$$P_0 = F_r + Y_0 F_a$$

The values of e , Y_2 , Y_3 , and Y_0 are given in the table below.

Boundary Dimensions (mm)				Basic Load Ratings (N)		Thermal Reference Speed	Speeds (min ⁻¹)		Bearing Designations	Abutment and Fillet Dimensions (mm)					Constant e	Axial Load Factors			Mass (kg) approx.		
d	D	B	$r_{min.}$	C_r	C_{0r}		Mechanical	Grease		Cylindrical Bore	d_a		D_a			r_a	Y_2	Y_3		Y_0	
										Tapered Bore ⁽¹⁾	min.	max.	max.	min.	max.						
20	52	15	1.1	29 300	26 900	10 000	—	6 300	21304CDE4	21304CDKE4		27	28	45	42	1	0.31	3.2	2.1	2.1	0.17
25	52	18	1	37 500	37 000	10 000	—	7 100	22205CE4	22205CKE4		31	31	46	45	1	0.35	2.9	1.9	1.9	0.17
	62	17	1.1	43 000	40 500	9 000	—	5 300	21305CDE4	21305CDKE4		32	34	55	51	1	0.29	3.4	2.3	2.3	0.26
30	62	20	1	50 000	50 000	8 500	—	6 000	22206CE4	22206CKE4		36	37	56	54	1	0.33	3.1	2.1	2.0	0.27
	72	19	1.1	55 000	54 000	7 500	—	4 500	21306CDE4	21306CDKE4		37	40	65	59	1	0.28	3.6	2.4	2.3	0.39
35	72	23	1.1	69 000	71 000	7 500	—	5 300	22207CE4	22207CKE4		42	43	65	63	1	0.32	3.1	2.1	2.0	0.42
	80	21	1.5	71 500	76 000	7 100	—	4 000	21307CDE4	21307CDKE4		44	47	71	67	1.5	0.28	3.6	2.4	2.4	0.53
40	80	23	1.1	113 000	99 500	7 100	12 000	6 700	* 22208EAE4	* 22208EAKE4		47	49	73	70	1	0.28	3.6	2.4	2.4	0.50
	90	23	1.5	118 000	111 000	6 700	11 000	6 000	* 21308EAE4	* 21308EAKE4		49	55	81	75	1.5	0.25	3.9	2.7	2.6	0.73
	90	33	1.5	170 000	153 000	5 600	9 000	5 300	* 22308EAE4	* 22308EAKE4		49	52	81	77	1.5	0.35	2.8	1.9	1.9	0.98
45	85	23	1.1	118 000	111 000	6 300	11 000	6 000	* 22209EAE4	* 22209EAKE4		52	55	78	75	1	0.25	3.9	2.7	2.6	0.55
	100	25	1.5	149 000	144 000	6 000	9 000	5 000	* 21309EAE4	* 21309EAKE4		54	65	91	89	1.5	0.23	4.3	2.9	2.8	0.96
	100	36	1.5	207 000	195 000	5 000	8 000	4 500	* 22309EAE4	* 22309EAKE4		54	60	91	86	1.5	0.34	2.9	2.0	1.9	1.34
50	90	23	1.1	124 000	119 000	6 000	9 500	5 600	* 22210EAE4	* 22210EAKE4		57	60	83	81	1	0.24	4.3	2.9	2.8	0.61
	110	27	2	178 000	174 000	5 300	8 000	4 500	* 21310EAE4	* 21310EAKE4		60	72	100	98	2	0.23	4.4	3.0	2.9	1.21
	110	40	2	246 000	234 000	4 800	7 100	4 300	* 22310EAE4	* 22310EAKE4		60	64	100	93	2	0.35	2.8	1.9	1.9	1.78
55	100	25	1.5	149 000	144 000	5 300	9 000	5 300	* 22211EAE4	* 22211EAKE4		64	65	91	89	1.5	0.23	4.3	2.9	2.8	0.81
	120	29	2	178 000	174 000	5 300	8 000	4 500	* 21311EAE4	* 21311EAKE4		65	72	110	98	2	0.23	4.4	3.0	2.9	1.58
	120	43	2	292 000	292 000	4 300	6 000	3 800	* 22311EAE4	* 22311EAKE4		65	73	110	103	2	0.34	2.9	2.0	1.9	2.3

Note (1) Suffix K represents bearings with tapered bores (taper 1:12).

Remarks 1. Bearings denoted by an asterisk (*) are NSKHPS bearings; they come standard with an oil groove and holes.
 2. The recommended fits (shaft tolerances) on Page A164 are different when selecting NSKHPS bearings. In this case, light loads are defined as $\leq 0.05C_r$, normal loads as 0.05 to 0.10 C_r , and heavy loads as $> 0.10C_r$.
 3. For the dimensions of adapters and withdrawal sleeves, refer to Pages C348 – C349 and C356.

SPHERICAL ROLLER BEARINGS

Bore Diameter 60 – 90 mm

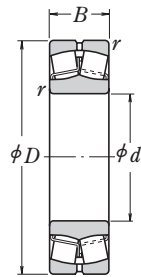

Cylindrical Bore

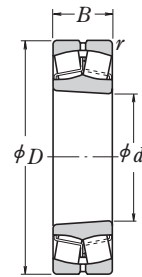

Tapered Bore

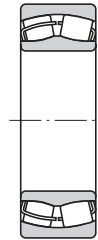

Without an Oil Groove or Holes

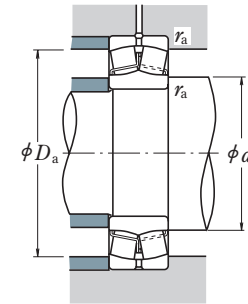

Dynamic Equivalent Load

$$P = XF_r + YF_a$$

$F_a/F_r \leq e$		$F_a/F_r > e$	
X	Y	X	Y
1	Y_3	0.67	Y_2

Static Equivalent Load

$$P_0 = F_r + Y_0 F_a$$

The values of e , Y_2 , Y_3 , and Y_0 are given in the table below.

Boundary Dimensions (mm)				Basic Load Ratings (N)		Thermal Reference Speed	Speeds (min ⁻¹)		Bearing Designations	Abutment and Fillet Dimensions (mm)					Constant e	Axial Load Factors			Mass (kg) approx.	
d	D	B	r min.	C_r	C_{0r}		Limiting Speeds			Cylindrical Bore	Tapered Bore ⁽¹⁾		d_a			D_a		r_a		Y_2
							Mechanical	Grease			min.	max.	max.	min.	max.					
60	95	26	1.1	98 500	141 000	4 800	—	3 600	*23012CE4 *22212EAE4 *21312EAE4 *22312EAE4	*23012CKE4 *22212EAKE4 *21312EAKE4 *22312EAKE4	67	68	88	85	1	0.26	3.9	2.6	2.5	0.68
	110	28	1.5	178 000	174 000	5 300	8 000	4 800			69	72	101	98	1.5	0.23	4.4	3.0	2.9	1.1
	130	31	2.1	238 000	244 000	4 800	6 700	3 800			72	87	118	117	2	0.22	4.5	3.0	3.0	1.98
	130	46	2.1	340 000	340 000	4 000	5 600	3 600			72	79	118	111	2	0.34	3.0	2.0	1.9	2.89
65	120	31	1.5	221 000	230 000	4 800	7 500	4 300	*22213EAE4 *21313EAE4 *22313EAE4	*22213EAKE4 *21313EAKE4 *22313EAKE4	74	80	111	107	1.5	0.24	4.2	2.8	2.7	1.51
	140	33	2.1	264 000	275 000	4 500	6 000	3 600			77	94	128	126	2	0.22	4.6	3.1	3.0	2.45
	140	48	2.1	375 000	380 000	3 800	5 000	3 200			77	84	128	119	2	0.34	3.0	2.0	2.0	3.52
70	125	31	1.5	225 000	232 000	4 500	7 100	4 000	*22214EAE4 *21314EAE4 *22314EAE4	*22214EAKE4 *21314EAKE4 *22314EAKE4	79	84	116	111	1.5	0.23	4.3	2.9	2.8	1.58
	150	35	2.1	310 000	325 000	4 300	5 600	3 200			82	101	138	135	2	0.22	4.6	3.1	3.0	3.0
	150	51	2.1	425 000	435 000	3 600	4 800	3 000			82	91	138	129	2	0.33	3.0	2.0	2.0	4.28
75	130	31	1.5	238 000	244 000	4 300	6 700	4 000	*22215EAE4 *21315EAE4 *22315EAE4	*22215EAKE4 *21315EAKE4 *22315EAKE4	84	87	121	117	1.5	0.22	4.5	3.0	3.0	1.64
	160	37	2.1	310 000	325 000	4 000	5 600	3 200			87	101	148	134	2	0.22	4.6	3.1	3.0	3.64
	160	55	2.1	485 000	505 000	3 400	4 300	2 800			87	97	148	137	2	0.33	3.0	2.0	2.0	5.26
80	140	33	2	264 000	275 000	4 000	6 000	3 600	*22216EAE4 *21316EAE4 *22316EAE4	*22216EAKE4 *21316EAKE4 *22316EAKE4	90	94	130	126	2	0.22	4.6	3.1	3.0	2.01
	170	39	2.1	355 000	375 000	3 800	4 800	3 000			92	109	158	146	2	0.23	4.4	3.0	2.9	4.32
	170	58	2.1	540 000	565 000	3 200	3 800	2 600			92	103	158	145	2	0.33	3.0	2.0	2.0	6.23
85	150	36	2	310 000	325 000	4 000	5 600	3 400	*22217EAE4 *21317EAE4 *22317EAE4	*22217EAKE4 *21317EAKE4 *22317EAKE4	95	101	140	135	2	0.22	4.6	3.1	3.0	2.54
	180	41	3	360 000	395 000	3 800	5 000	3 000			99	108	166	142	2.5	0.24	4.3	2.9	2.8	5.2
	180	60	3	600 000	630 000	3 000	3 400	2 400			99	110	166	155	2.5	0.33	3.1	2.1	2.0	7.23
90	160	40	2	360 000	395 000	3 800	5 000	3 200	*22218EAE4 *23218CE4 *21318EAE4 *22318EAE4	*22218EAKE4 *23218CKE4 *21318EAKE4 *22318EAKE4	100	108	150	142	2	0.24	4.3	2.9	2.8	3.3
	160	52.4	2	340 000	490 000	2 800	—	1 800			100	105	150	138	2	0.32	3.2	2.1	2.1	4.51
	190	43	3	415 000	450 000	3 600	4 500	2 800			104	115	176	152	2.5	0.24	4.3	2.9	2.8	6.1
	190	64	3	665 000	705 000	2 800	3 000	2 400			104	115	176	163	2.5	0.33	3.1	2.1	2.0	8.56

Note (1) Suffix K represents bearings with tapered bores (taper 1:12).

Remarks 1. Bearings denoted by an asterisk (*) are NSKHPS bearings; they come standard with an oil groove and holes.
 2. The recommended fits (shaft tolerances) on Page A164 are different when selecting NSKHPS bearings.
 In this case, light loads are defined as $\leq 0.05C_r$ normal loads as 0.05 to 0.10 C_r , and heavy loads as $> 0.10C_r$.
 3. For the dimensions of adapters and withdrawal sleeves, refer to Pages C349 – C350 and C356.

SPHERICAL ROLLER BEARINGS

Bore Diameter 95 – 110 mm

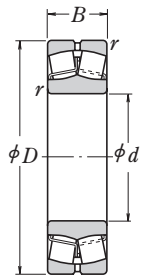

Cylindrical Bore

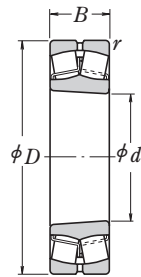

Tapered Bore

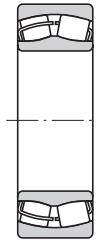

Without an Oil Groove or Holes

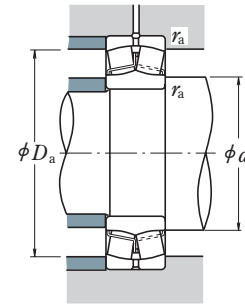

Dynamic Equivalent Load

$$P = XF_r + YF_a$$

$F_a/F_r \leq e$		$F_a/F_r > e$	
X	Y	X	Y
1	Y_3	0.67	Y_2

Static Equivalent Load

$$P_0 = F_r + Y_0 F_a$$

The values of e , Y_2 , Y_3 , and Y_0 are given in the table below.

Boundary Dimensions (mm)				Basic Load Ratings (N)		Thermal Reference Speed	Speeds (min ⁻¹)		Bearing Designations	Abutment and Fillet Dimensions (mm)					Constant e	Axial Load Factors			Mass (kg) approx.		
d	D	B	r min.	C_r	C_{0r}		Limiting Speeds			Cylindrical Bore	Tapered Bore ⁽¹⁾	d_a		D_a		r_a	Y_2	Y_3		Y_0	
							Mechanical	Grease				min.	max.	min.							max.
95	170	43	2.1	415 000	450 000	3 800	4 500	3 000	*22219EAE4	*22219EAKE4	107	115	158	152	2	0.24	4.3	2.9	2.8	4.04	
	170	55.6	2.1	370 000	525 000	2 600	—	1 700	23219CAME4	23219CAMKE4	107	—	158	146	2	0.32	3.1	2.1	2.0	5.33	
	200	45	3	430 000	435 000	3 600	4 800	1 500	*21319CAME4	*21319CAMKE4	109	—	186	172	2.5	0.22	4.6	3.1	3.0	6.92	
	200	45	3	345 000	435 000	3 400	—	1 500	21319CE4	21319CKE4	109	127	186	172	2.5	0.22	4.6	3.1	3.0	6.92	
	200	67	3	735 000	780 000	2 600	3 000	2 200	*22319EAE4	*22319EAKE4	109	121	186	172	2.5	0.33	3.1	2.1	2.0	9.91	
	150	37	1.5	212 000	335 000	3 200	—	2 200	23020CDE4	23020CDKE4	109	112	141	136	1.5	0.22	4.6	3.1	3.0	2.31	
100	150	50	1.5	276 000	470 000	2 800	—	1 800	24020CE4	24020CK30E4	109	110	141	132	1.5	0.30	3.4	2.3	2.2	3.08	
	165	52	2	345 000	530 000	2 800	—	1 700	23120CE4	23120CKE4	110	113	155	144	2	0.30	3.4	2.3	2.2	4.38	
	165	65	2	345 000	535 000	2 400	—	1 700	24120CAME4	24120CAMK30E4	110	—	155	143	2	0.35	2.9	1.9	1.9	5.42	
	180	46	2.1	455 000	490 000	3 600	4 300	2 800	*22220EAE4	*22220EAKE4	112	119	168	160	2	0.24	4.3	2.9	2.8	4.84	
	180	60.3	2.1	525 000	605 000	2 800	3 800	1 600	*23220CAME4	*23220CAMKE4	112	—	168	155	2	0.32	3.2	2.1	2.1	6.6	
	180	60.3	2.1	420 000	605 000	2 600	—	1 600	23220CE4	23220CKE4	112	118	168	155	2	0.32	3.2	2.1	2.1	6.6	
110	215	47	3	495 000	485 000	3 400	4 500	1 400	*21320CAME4	*21320CAMKE4	114	—	201	184	2.5	0.23	4.4	3.0	2.9	8.46	
	215	47	3	395 000	485 000	3 200	—	1 400	21320CE4	21320CKE4	114	133	201	184	2.5	0.21	4.7	3.2	3.1	8.46	
	215	73	3	750 000	785 000	2 600	3 400	1 700	*22320CAME4 ⁽²⁾	*22320CAMKE4 ⁽²⁾	114	—	201	184	2.5	0.35	2.9	1.9	1.9	12.7	
	170	45	2	293 000	465 000	3 200	—	2 000	23022CDE4	23022CDKE4	120	124	160	153	2	0.24	4.2	2.8	2.8	3.76	
	170	60	2	380 000	645 000	2 600	—	1 600	24022CE4	24022CK30E4	120	121	160	148	2	0.32	3.1	2.1	2.1	4.96	
	180	56	2	480 000	630 000	3 200	4 000	1 600	*23122CAME4	*23122CAMKE4	120	—	170	158	2	0.28	3.5	2.4	2.3	5.7	
	180	56	2	385 000	630 000	2 600	—	1 600	23122CE4	23122CKE4	120	127	170	158	2	0.28	3.5	2.4	2.3	5.7	
	180	69	2	575 000	750 000	2 200	3 400	1 600	*24122CAME4	*24122CAMK30E4	120	—	170	154	2	0.36	2.8	1.9	1.8	6.84	
	180	69	2	460 000	750 000	2 000	—	1 600	24122CE4	24122CK30E4	120	123	170	154	2	0.36	2.8	1.9	1.8	6.84	
	200	53	2.1	605 000	645 000	3 400	3 400	2 600	*22222EAE4	*22222EAKE4	122	129	188	178	2	0.25	4.0	2.7	2.6	6.99	
	200	69.8	2.1	645 000	760 000	2 600	3 400	1 500	*23222CAME4	*23222CAMKE4	122	—	188	170	2	0.34	3.0	2.0	1.9	9.54	
	200	69.8	2.1	515 000	760 000	2 200	—	1 500	23222CE4	23222CKE4	122	130	188	170	2	0.34	3.0	2.0	1.9	9.54	
240	50	3	565 000	545 000	3 000	4 300	1 300	*21322CAME4	*21322CAMKE4	124	—	226	206	2.5	0.22	4.6	3.1	3.0	11.2		
240	80	3	925 000	980 000	2 200	3 000	1 500	*22322CAME4 ⁽²⁾	*22322CAMKE4 ⁽²⁾	124	—	226	206	2.5	0.35	2.9	1.9	1.9	17.6		

Notes (1) Suffixes K and K30 represent bearings with tapered bores (taper 1:12 or 1:30).
 (2) EA bearings are also available. The load rating of EA bearings is around 10% higher than CAM bearings; please consult NSK for more information.

Remarks 1. Bearings denoted by an asterisk (*) are NSKHPS bearings; they come standard with an oil groove and holes.
 2. The recommended fits (shaft tolerances) on Page A164 are different when selecting NSKHPS bearings. In this case, light loads are defined as $\leq 0.05C_r$ normal loads as 0.05 to 0.10 C_r , and heavy loads as $> 0.10C_r$.
 3. For the dimensions of adapters and withdrawal sleeves, refer to Pages C351 and C357.

SPHERICAL ROLLER BEARINGS

Bore Diameter 120 – 130 mm

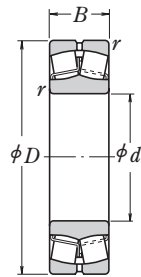

Cylindrical Bore

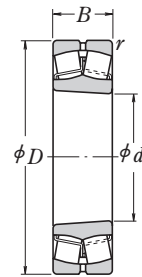

Tapered Bore

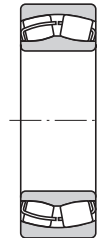

Without an Oil Groove or Holes

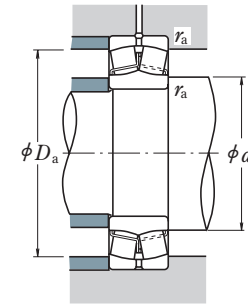

Dynamic Equivalent Load

$$P = XF_r + YF_a$$

$F_a/F_r \leq e$		$F_a/F_r > e$	
X	Y	X	Y
1	Y_3	0.67	Y_2

Static Equivalent Load

$$P_0 = F_r + Y_0 F_a$$

The values of e , Y_2 , Y_3 , and Y_0 are given in the table below.

Boundary Dimensions (mm)				Basic Load Ratings (N)		Thermal Reference Speed	Speeds (min ⁻¹)		Bearing Designations	Abutment and Fillet Dimensions (mm)					Constant e	Axial Load Factors			Mass (kg) approx.	
d	D	B	r min.	C_r	C_{0r}		Limiting Speeds Mechanical	Grease		Cylindrical Bore	Tapered Bore ⁽¹⁾		d_a			D_a	r_a	Y_2		Y_3
											min.	max.	min.	max.	max.	min.				
120	180	46	2	395 000	525 000	3 200	4 500	1 800	*23024CAME4	*23024CAMKE4	130	—	170	163	2	0.22	4.5	3.0	2.9	4.11
	180	46	2	315 000	525 000	2 800	—	1 800	23024CDE4	23024CDKE4	130	134	170	163	2	0.22	4.5	3.0	2.9	4.11
	180	60	2	480 000	680 000	2 600	3 600	1 500	*24024CAME4	*24024CAMK30E4	130	—	170	158	2	0.32	3.2	2.1	2.1	5.33
	180	60	2	395 000	705 000	2 400	—	1 500	24024CE4	24024CK30E4	130	131	170	158	2	0.32	3.2	2.1	2.1	5.33
	200	62	2	580 000	720 000	2 800	3 600	1 400	*23124CAME4	*23124CAMKE4	130	—	190	175	2	0.29	3.5	2.4	2.3	7.85
	200	62	2	465 000	720 000	2 400	—	1 400	23124CE4	23124CKE4	130	138	190	175	2	0.29	3.5	2.4	2.3	7.85
	200	80	2	695 000	905 000	2 000	3 000	1 400	*24124CAME4	*24124CAMK30E4	130	—	190	171	2	0.37	2.7	1.8	1.8	10
	200	80	2	575 000	950 000	1 800	—	1 400	24124CE4	24124CK30E4	130	136	190	171	2	0.37	2.7	1.8	1.8	10
	215	58	2.1	685 000	765 000	3 200	3 000	2 400	*22224EAE4	*22224EAKE4	132	142	203	190	2	0.25	3.9	2.7	2.6	8.8
	215	76	2.1	790 000	970 000	2 200	3 000	1 300	*23224CAME4	*23224CAMKE4	132	—	203	182	2	0.34	2.9	2.0	1.9	12.1
	215	76	2.1	630 000	970 000	2 000	—	1 300	23224CE4	23224CKE4	132	140	203	182	2	0.34	2.9	2.0	1.9	12.1
	260	86	3	1060 000	1 120 000	2 000	2 800	1 400	*22324CAME4 ⁽²⁾	*22324CAMKE4 ⁽²⁾	134	—	246	222	2.5	0.35	2.9	1.9	1.9	22.2
130	200	52	2	500 000	655 000	3 000	3 800	1 700	*23026CAME4	*23026CAMKE4	140	—	190	180	2	0.23	4.3	2.9	2.8	5.98
	200	52	2	400 000	655 000	2 800	—	1 700	23026CDE4	23026CDKE4	140	147	190	180	2	0.23	4.3	2.9	2.8	5.98
	200	69	2	620 000	865 000	2 200	3 200	1 400	*24026CAME4	*24026CAMK30E4	140	—	190	175	2	0.31	3.2	2.2	2.1	7.84
	200	69	2	495 000	865 000	2 200	—	1 400	24026CE4	24026CK30E4	140	143	190	175	2	0.31	3.2	2.2	2.1	7.84
	210	64	2	630 000	825 000	2 600	3 400	1 300	*23126CAME4	*23126CAMKE4	140	—	200	184	2	0.28	3.6	2.4	2.4	8.69
	210	64	2	505 000	825 000	2 200	—	1 300	23126CE4	23126CKE4	140	149	200	184	2	0.28	3.6	2.4	2.4	8.69
	210	80	2	735 000	1 010 000	1 800	2 800	1 300	*24126CAME4	*24126CAMK30E4	140	—	200	180	2	0.37	2.7	1.8	1.8	10.7
	210	80	2	590 000	1 010 000	1 600	—	1 300	24126CE4	24126CK30E4	140	146	200	180	2	0.35	2.9	1.9	1.9	10.7
	230	64	3	820 000	940 000	2 800	2 600	2 200	*22226EAE4	*22226EAKE4	144	152	216	204	2.5	0.26	3.8	2.6	2.5	11
	230	80	3	875 000	1 080 000	2 000	2 800	1 200	*23226CAME4	*23226CAMKE4	144	—	216	196	2.5	0.34	2.9	2.0	1.9	14.3
	230	80	3	700 000	1 080 000	1 800	—	1 200	23226CE4	23226CKE4	144	150	216	196	2.5	0.34	2.9	2.0	1.9	14.3
	280	93	4	1 240 000	1 350 000	1 800	2 600	1 300	*22326CAME4	*22326CAMKE4	148	—	262	236	3	0.34	2.9	2.0	1.9	28.1
280	93	4	995 000	1 350 000	1 900	—	1 300	22326CE4	22326CKE4	148	166	262	236	3	0.34	2.9	2.0	1.9	28.1	

Notes (1) Suffixes K and K30 represent bearings with tapered bores (taper 1:12 or 1:30).
 (2) EA bearings are also available. The load rating of EA bearings is around 10% higher than CAM bearings; please consult NSK for more information.

Remarks 1. Bearings denoted by an asterisk (*) are NSKHPS bearings; they come standard with an oil groove and holes.
 2. The recommended fits (shaft tolerances) on Page A164 are different when selecting NSKHPS bearings. In this case, light loads are defined as $\leq 0.05C_r$ normal loads as 0.05 to 0.10 C_r , and heavy loads as $> 0.10C_r$.
 3. For the dimensions of adapters and withdrawal sleeves, refer to Pages C351 and C357.

SPHERICAL ROLLER BEARINGS

Bore Diameter 140 – 150 mm

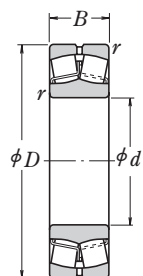

Cylindrical Bore

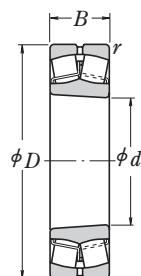

Tapered Bore

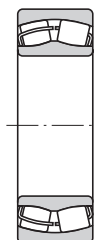

Without an Oil Groove or Holes

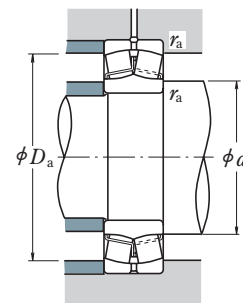

Dynamic Equivalent Load

$$P = XF_r + YF_a$$

$F_a/F_r \leq e$		$F_a/F_r > e$	
X	Y	X	Y
1	Y_3	0.67	Y_2

Static Equivalent Load

$$P_0 = F_r + Y_0 F_a$$

The values of e , Y_2 , Y_3 , and Y_0 are given in the table below.

Boundary Dimensions (mm)				Basic Load Ratings (N)		Thermal Reference Speed	Speeds (min ⁻¹)		Bearing Designations	Abutment and Fillet Dimensions (mm)					Constant e	Axial Load Factors			Mass (kg) approx.	
d	D	B	r min.	C_r	C_{0r}		Limiting Speeds Mechanical	Grease		Cylindrical Bore	Tapered Bore ⁽¹⁾		d_a			D_a	r_a	Y_2		Y_3
											min.	max.	max.	min.	max.					
140	210	53	2	525 000	715 000	2 800	3 800	1 600	*23028CAME4	*23028CAMKE4	150	—	200	190	2	0.22	4.5	3.0	2.9	6.49
	210	53	2	420 000	715 000	2 400	—	1 600	23028CDE4	23028CDKE4	150	157	200	190	2	0.22	4.5	3.0	2.9	6.49
	210	69	2	635 000	905 000	2 200	3 000	1 300	*24028CAME4	*24028CAMK30E4	150	—	200	186	2	0.31	3.4	2.3	2.2	8.37
	210	69	2	525 000	945 000	2 000	—	1 300	24028CE4	24028CK30E4	150	154	200	186	2	0.29	3.4	2.3	2.2	8.37
	225	68	2.1	725 000	945 000	2 400	3 200	1 200	*23128CAME4	*23128CAMKE4	152	—	213	198	2	0.28	3.6	2.4	2.3	10.5
	225	68	2.1	580 000	945 000	2 000	—	1 200	23128CE4	23128CKE4	152	158	213	198	2	0.28	3.6	2.4	2.3	10.5
	225	85	2.1	835 000	1 160 000	1 600	2 600	1 200	*24128CAME4	*24128CAMK30E4	152	—	213	193	2	0.37	2.7	1.8	1.8	13
	225	85	2.1	670 000	1 160 000	1 500	—	1 200	24128CE4	24128CK30E4	152	156	213	193	2	0.35	2.9	1.9	1.9	13
	250	68	3	835 000	945 000	2 600	3 200	1 400	*22228CAME4	*22228CAMKE4	154	—	236	221	2.5	0.26	3.9	2.6	2.5	14.5
	250	68	3	645 000	930 000	2 400	—	1 400	22228CDE4	22228CDKE4	154	167	236	219	2.5	0.25	4.0	2.7	2.6	14.5
	250	88	3	1 040 000	1 300 000	1 800	2 600	1 100	*23228CAME4	*23228CAMKE4	154	—	236	213	2.5	0.35	2.9	1.9	1.9	18.8
	250	88	3	835 000	1 300 000	1 600	—	1 100	23228CE4	23228CKE4	154	163	236	213	2.5	0.35	2.9	1.9	1.9	18.8
300	102	4	1 450 000	1 590 000	1 700	2 400	1 200	*22328CAME4	*22328CAMKE4	158	—	282	253	3	0.35	2.9	1.9	1.9	35.4	
	300	102	4	1 160 000	1 590 000	1 700	—	1 200	22328CE4	22328CKE4	158	177	282	253	3	0.35	2.9	1.9	1.9	35.4
150	225	56	2.1	590 000	815 000	2 600	3 600	1 400	*23030CAME4	*23030CAMKE4	162	—	213	203	2	0.22	4.6	3.1	3.0	7.9
	225	56	2.1	470 000	815 000	2 200	—	1 400	23030CDE4	23030CDKE4	162	168	213	203	2	0.22	4.6	3.1	3.0	7.9
	225	75	2.1	740 000	1 090 000	1 900	3 000	1 200	*24030CAME4	*24030CAMK30E4	162	—	213	198	2	0.30	3.4	2.3	2.2	10.5
	225	75	2.1	590 000	1 090 000	1 800	—	1 200	24030CE4	24030CK30E4	162	165	213	198	2	0.30	3.4	2.3	2.2	10.5
	250	80	2.1	905 000	1 180 000	2 200	2 800	1 100	*23130CAME4	*23130CAMKE4	162	—	238	218	2	0.30	3.4	2.3	2.2	15.8
	250	80	2.1	725 000	1 180 000	1 800	—	1 100	23130CE4	23130CKE4	162	174	238	218	2	0.30	3.4	2.3	2.2	15.8
	250	100	2.1	1 070 000	1 450 000	1 400	2 400	1 100	*24130CAME4	*24130CAMK30E4	162	—	238	212	2	0.38	2.6	1.8	1.7	19.8
	250	100	2.1	890 000	1 530 000	1 300	—	1 100	24130CE4	24130CK30E4	162	169	238	212	2	0.38	2.6	1.8	1.7	19.8
	270	73	3	955 000	1 120 000	2 400	3 000	1 300	*22230CAME4	*22230CAMKE4	164	—	256	236	2.5	0.26	3.9	2.6	2.5	18.4
	270	73	3	765 000	1 120 000	2 200	—	1 300	22230CDE4	22230CDKE4	164	179	256	236	2.5	0.26	3.9	2.6	2.5	18.4
	270	96	3	1 220 000	1 560 000	1 700	2 400	1 100	*23230CAME4	*23230CAMKE4	164	—	256	230	2.5	0.35	2.9	1.9	1.9	24.2
	270	96	3	975 000	1 560 000	1 500	—	1 100	23230CE4	23230CKE4	164	176	256	230	2.5	0.35	2.9	1.9	1.9	24.2
320	108	4	1 530 000	1 690 000	1 600	2 200	1 100	*22330CAME4	*22330CAMKE4	168	—	302	270	3	0.35	2.9	1.9	1.9	41.5	

Note (1) Suffixes K and K30 represent bearings with tapered bores (taper 1:12 or 1:30).

Remarks 1. Bearings denoted by an asterisk (*) are NSKHPS bearings; they come standard with an oil groove and holes.
 2. The recommended fits (shaft tolerances) on Page A164 are different when selecting NSKHPS bearings. In this case, light loads are defined as $\leq 0.05C_r$ normal loads as 0.05 to 0.10 C_r , and heavy loads as $> 0.10C_r$.
 3. For the dimensions of adapters and withdrawal sleeves, refer to Pages C352 and C357 – C358.

SPHERICAL ROLLER BEARINGS

Bore Diameter 160 – 170 mm

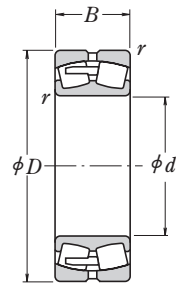

Cylindrical Bore

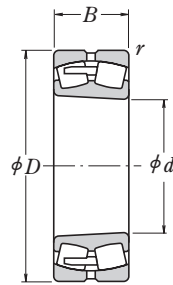

Tapered Bore



Without an Oil Groove and Holes

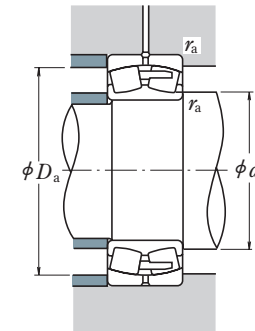

Dynamic Equivalent Load

$$P = XF_r + YF_a$$

$F_a/F_r \leq e$		$F_a/F_r > e$	
X	Y	X	Y
1	Y_3	0.67	Y_2

Static Equivalent Load

$$P_0 = F_r + Y_0 F_a$$

The values of e , Y_2 , Y_3 , and Y_0 are given in the table below.

Boundary Dimensions (mm)				Basic Load Ratings (N)		Thermal Reference Speed	Speeds (min ⁻¹)		Bearing Designations	Abutment and Fillet Dimensions (mm)					Constant e	Axial Load Factors			Mass (kg) approx.	
d	D	B	r min.	C_r	C_{0r}		Limiting Speeds Mechanical Grease	Cylindrical Bore		Tapered Bore ⁽¹⁾	d_a		D_a			r_a	Y_2	Y_3		Y_0
												min.	max.	min.	max.	max.				
160	220	45	2	450 000	675 000	3 000	3 200	1 400	*23932CAME4	*23932CAMKE4	170	—	210	203	2	0.18	5.6	3.8	3.7	4.97
	240	60	2.1	675 000	955 000	2 400	3 200	1 300	*23032CAME4	*23032CAMKE4	172	—	228	216	2	0.22	4.5	3.0	2.9	9.66
	240	60	2.1	540 000	955 000	2 200	—	1 300	23032CDE4	23032CDE4	172	179	228	216	2	0.22	4.5	3.0	2.9	9.66
	240	80	2.1	845 000	1 260 000	1 800	2 800	1 100	*24032CAME4	*24032CAMK30E4	172	—	228	212	2	0.30	3.4	2.3	2.2	12.7
	240	80	2.1	680 000	1 260 000	1 700	—	1 100	24032CE4	24032CK30E4	172	177	228	212	2	0.30	3.4	2.3	2.2	12.7
	270	86	2.1	1 070 000	1 400 000	2 000	2 600	1 000	*23132CAME4	*23132CAMKE4	172	—	258	234	2	0.30	3.4	2.3	2.2	20.3
	270	86	2.1	855 000	1 400 000	1 700	—	1 000	23132CE4	23132CKE4	172	185	258	234	2	0.30	3.4	2.3	2.2	20.3
	270	109	2.1	1 240 000	1 670 000	1 300	2 200	1 000	*24132CAME4	*24132CAMK30E4	172	—	258	229	2	0.39	2.6	1.7	1.7	25.4
	270	109	2.1	1 040 000	1 760 000	1 200	—	1 000	24132CE4	24132CK30E4	172	179	258	229	2	0.39	2.6	1.7	1.7	25.4
	290	80	3	1 140 000	1 320 000	2 200	2 800	1 200	*22232CAME4	*22232CAMKE4	174	—	276	255	2.5	0.26	3.8	2.6	2.5	23.1
	290	80	3	910 000	1 320 000	2 000	—	1 200	22232CDE4	22232CDE4	174	190	276	255	2.5	0.26	3.8	2.6	2.5	23.1
	290	104	3	1 370 000	1 770 000	1 500	2 200	1 000	*23232CAME4	*23232CAMKE4	174	—	276	245	2.5	0.34	2.9	2.0	1.9	30.5
	290	104	3	1 100 000	1 770 000	1 400	—	1 000	23232CE4	23232CKE4	174	189	276	245	2.5	0.34	2.9	2.0	1.9	30.5
	340	114	4	1 700 000	1 900 000	1 400	2 200	1 100	*22332CAME4	*22332CAMKE4	178	—	322	287	3	0.35	2.9	1.9	1.9	49.3
	170	230	45	2	450 000	680 000	3 000	3 600	1 400	*23934CAME4	*23934CAMKE4	180	—	220	213	2	0.17	5.8	3.9	3.8
260		67	2.1	795 000	1 090 000	2 200	3 000	1 200	*23034CAME4	*23034CAMKE4	182	—	248	233	2	0.23	4.3	2.9	2.8	13
260		67	2.1	640 000	1 090 000	2 000	—	1 200	23034CDE4	23034CDE4	182	191	248	233	2	0.23	4.3	2.9	2.8	13
260		90	2.1	1 030 000	1 520 000	1 600	2 400	1 000	*24034CAME4	*24034CAMK30E4	182	—	248	228	2	0.31	3.2	2.2	2.1	17.3
260		90	2.1	825 000	1 520 000	1 500	—	1 000	24034CE4	24034CK30E4	182	188	248	228	2	0.31	3.2	2.2	2.1	17.3
280		88	2.1	1 180 000	1 570 000	1 800	2 600	1 000	*23134CAME4	*23134CAMKE4	182	—	268	245	2	0.29	3.5	2.3	2.3	21.8
280		88	2.1	940 000	1 570 000	1 500	—	1 000	23134CE4	23134CKE4	182	194	268	245	2	0.29	3.5	2.3	2.3	21.8
280		109	2.1	1 280 000	1 770 000	1 200	2 200	1 000	*24134CAME4	*24134CAMK30E4	182	—	268	239	2	0.38	2.7	1.8	1.7	26.6
280		109	2.1	1 080 000	1 860 000	1 100	—	1 000	24134CE4	24134CK30E4	182	190	268	239	2	0.37	2.7	1.8	1.8	26.6
310		86	4	1 240 000	1 500 000	2 000	2 600	1 100	*22234CAME4	*22234CAMKE4	188	—	292	270	3	0.26	3.8	2.6	2.5	28.8
310		86	4	990 000	1 500 000	1 800	—	1 100	22234CDE4	22234CDE4	188	206	292	270	3	0.26	3.8	2.6	2.5	28.8
310		110	4	1 500 000	1 910 000	1 400	2 200	900	*23234CAME4	*23234CAMKE4	188	—	292	261	3	0.35	2.9	1.9	1.9	36.4
310		110	4	1 200 000	1 910 000	1 300	—	900	23234CE4	23234CKE4	188	201	292	261	3	0.34	2.9	2.0	1.9	36.4
360		120	4	1 970 000	2 110 000	1 300	2 000	1 000	*22334CAME4	*22334CAMKE4	188	—	342	304	3	0.35	2.9	1.9	1.9	57.9

Note (1) Suffixes K and K30 represent bearings with tapered bores (taper 1:12 or 1:30).

Remarks 1. Bearings denoted by an asterisk (*) are NSKHPS bearings; they come standard with an oil groove and holes.
 2. The recommended fits (shaft tolerances) on Page A164 are different when selecting NSKHPS bearings. In this case, light loads are defined as $\leq 0.05C_r$ normal loads as 0.05 to 0.10 C_r , and heavy loads as $> 0.10C_r$.
 3. For the dimensions of adapters and withdrawal sleeves, refer to Pages C352 and C358.

SPHERICAL ROLLER BEARINGS

Bore Diameter 180 – 190 mm

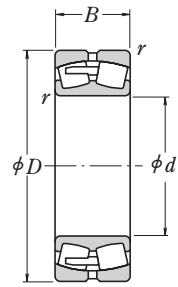

Cylindrical Bore

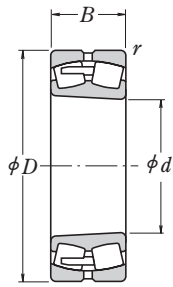

Tapered Bore



Without an Oil Groove and Holes

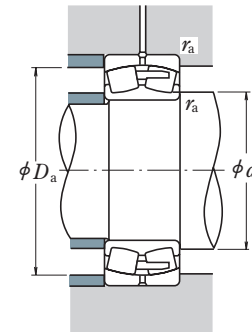

Dynamic Equivalent Load

$$P = XF_r + YF_a$$

$F_a/F_r \leq e$		$F_a/F_r > e$	
X	Y	X	Y
1	Y_3	0.67	Y_2

Static Equivalent Load

$$P_0 = F_r + Y_0 F_a$$

The values of e , Y_2 , Y_3 , and Y_0 are given in the table below.

Boundary Dimensions (mm)				Basic Load Ratings (N)		Thermal Reference Speed	Speeds (min ⁻¹)		Bearing Designations	Abutment and Fillet Dimensions (mm)					Constant e	Axial Load Factors			Mass (kg) approx.	
d	D	B	r min.	C_r	C_{0r}		Limiting Speeds Mechanical	Grease		Cylindrical Bore	Tapered Bore ⁽¹⁾		d_a			D_a	r_a	Y_2		Y_3
											min.	max.	max.	min.	max.					
180	250	52	2	590 000	890 000	2 600	3 000	1 200	*23936CAME4	*23936CAMKE4	190	—	240	230	2	0.18	5.5	3.7	3.6	7.64
	280	74	2.1	935 000	1 270 000	2 000	2 800	1 200	*23036CAME4	*23036CAMKE4	192	—	268	249	2	0.24	4.2	2.8	2.8	17.1
	280	74	2.1	750 000	1 270 000	1 900	—	1 200	23036CDE4	23036CKE4	192	202	268	249	2	0.24	4.2	2.8	2.8	17.1
	280	100	2.1	1 210 000	1 750 000	1 500	2 200	950	*24036CAME4	*24036CAMK30E4	192	—	268	245	2	0.32	3.1	2.1	2.0	22.7
	280	100	2.1	965 000	1 750 000	1 400	—	950	24036CE4	24036CK30E4	192	200	268	245	2	0.32	3.1	2.1	2.0	22.7
	300	96	3	1 320 000	1 760 000	1 700	2 200	900	*23136CAME4	*23136CAMKE4	194	—	286	260	2.5	0.31	3.3	2.2	2.2	27.5
	300	96	3	1 050 000	1 760 000	1 400	—	900	23136CE4	23136CKE4	194	206	286	260	2.5	0.30	3.4	2.3	2.2	27.5
	300	118	3	1 490 000	2 040 000	1 100	2 000	900	*24136CAME4	*24136CAMK30E4	194	—	286	255	2.5	0.37	2.7	1.8	1.8	33.1
	300	118	3	1 190 000	2 040 000	1 000	—	900	24136CE4	24136CK30E4	194	202	286	255	2.5	0.37	2.7	1.8	1.8	33.1
	320	86	4	1 280 000	1 540 000	2 000	2 600	1 100	*22236CAME4	*22236CAMKE4	198	—	302	278	3	0.26	3.9	2.6	2.6	30.2
	320	86	4	1 020 000	1 540 000	1 800	—	1 100	22236CDE4	22236CKE4	198	212	302	278	3	0.26	3.9	2.6	2.6	30.2
	320	112	4	1 620 000	2 110 000	1 300	2 000	850	*23236CAME4	*23236CAMKE4	198	—	302	274	3	0.35	2.9	1.9	1.9	38.9
190	260	52	2	575 000	875 000	2 600	3 000	1 200	*23938CAME4	*23938CAMKE4	200	—	250	240	2	0.18	5.7	3.8	3.7	8.03
	290	75	2.1	970 000	1 350 000	2 000	2 600	1 100	*23038CAME4	*23038CAMKE4	202	—	278	261	2	0.24	4.2	2.8	2.8	17.6
	290	100	2.1	1 220 000	1 840 000	1 400	2 200	900	*24038CAME4	*24038CAMK30E4	202	—	278	253	2	0.32	3.1	2.1	2.0	24
	290	100	2.1	975 000	1 840 000	1 400	—	900	24038CE4	24038CK30E4	202	210	278	253	2	0.31	3.2	2.2	2.1	24
	320	104	3	1 480 000	2 020 000	1 600	2 200	850	*23138CAME4	*23138CAMKE4	204	—	306	276	2.5	0.31	3.2	2.2	2.1	34.5
	320	104	3	1 190 000	2 020 000	1 300	—	850	23138CE4	23138CKE4	204	219	306	276	2.5	0.31	3.3	2.2	2.2	34.5
	320	128	3	1 710 000	2 330 000	1 000	1 900	850	*24138CAME4	*24138CAMK30E4	204	—	306	269	2.5	0.40	2.5	1.7	1.6	41.5
	320	128	3	1 370 000	2 330 000	950	—	850	24138CE4	24138CK30E4	204	211	306	269	2.5	0.40	2.5	1.7	1.6	41.5
	340	92	4	1 420 000	1 730 000	1 800	2 400	1 000	*22238CAME4	*22238CAMKE4	208	—	322	296	3	0.26	3.8	2.6	2.5	35.5
	340	120	4	1 800 000	2 350 000	1 200	1 900	800	*23238CAME4	*23238CAMKE4	208	—	322	288	3	0.35	2.8	1.9	1.9	47.6
	340	120	4	1 440 000	2 350 000	1 100	—	800	23238CE4	23238CKE4	208	222	322	288	3	0.35	2.9	1.9	1.9	47.6
	400	132	5	2 370 000	2 590 000	1 200	1 900	900	*22338CAME4	*22338CAMKE4	212	—	378	338	4	0.34	2.9	2.0	1.9	77.6

Note (1) Suffixes K and K30 represent bearings with tapered bores (taper 1:12 or 1:30).

Remarks 1. Bearings denoted by an asterisk (*) are NSKHPS bearings; they come standard with an oil groove and holes.
 2. The recommended fits (shaft tolerances) on Page A164 are different when selecting NSKHPS bearings. In this case, light loads are defined as $\leq 0.05C_r$ normal loads as 0.05 to 0.10 C_r , and heavy loads as $> 0.10C_r$.
 3. For the dimensions of adapters and withdrawal sleeves, refer to Pages C352 and C358.

SPHERICAL ROLLER BEARINGS

Bore Diameter 200 – 220 mm

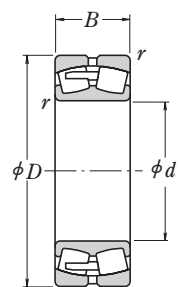

Cylindrical Bore

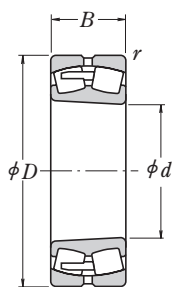

Tapered Bore



Without an Oil Groove and Holes

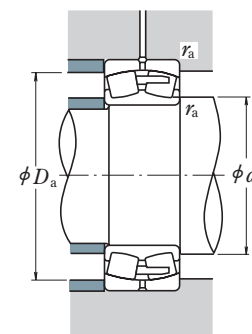

Dynamic Equivalent Load

$$P = XF_r + YF_a$$

$F_a/F_r \leq e$		$F_a/F_r > e$	
X	Y	X	Y
1	Y_3	0.67	Y_2

Static Equivalent Load

$$P_0 = F_r + Y_0 F_a$$

The values of e , Y_2 , Y_3 , and Y_0 are given in the table below.

Boundary Dimensions (mm)				Basic Load Ratings (N)		Thermal Reference Speed	Speeds (min^{-1})		Bearing Designations	Abutment and Fillet Dimensions (mm)					Constant e	Axial Load Factors			Mass (kg) approx.	
d	D	B	r_{min}	C_r	C_{0r}		Mechanical	Grease		Cylindrical Bore	d_a		D_a			r_a	Y_2	Y_3		Y_0
											min.	max.	max.	min.	max.					
200	280	60	2.1	710 000	1 060 000	2 400	2 600	1 100	*23940CAME4	*23940CAMKE4	212	—	268	258	2	0.20	5.1	3.4	3.3	11
	310	82	2.1	1 180 000	1 700 000	1 800	2 400	1 000	*23040CAME4	*23040CAMKE4	212	—	298	279	2	0.25	4.0	2.7	2.6	22.6
	310	109	2.1	1 420 000	2 120 000	1 300	2 000	850	*24040CAME4	*24040CAMK30E4	212	—	298	271	2	0.33	3.0	2.0	2.0	30.4
	310	109	2.1	1 140 000	2 120 000	1 300	—	850	24040CE4	24040CK30E4	212	223	298	271	2	0.32	3.1	2.1	2.0	30.4
	340	112	3	1 700 000	2 330 000	1 500	2 000	800	*23140CAME4	*23140CAMKE4	214	—	326	293	2.5	0.32	3.2	2.1	2.1	42.7
	340	112	3	1 360 000	2 330 000	1 200	—	800	23140CE4	23140CKE4	214	232	326	293	2.5	0.31	3.2	2.2	2.1	42.7
	340	140	3	1 960 000	2 660 000	950	1 800	800	*24140CAME4	*24140CAMK30E4	214	—	326	290	2.5	0.39	2.5	1.7	1.7	51.3
	340	140	3	1 570 000	2 670 000	900	—	800	24140CE4	24140CK30E4	214	226	326	290	2.5	0.39	2.6	1.8	1.7	51.3
	360	98	4	1 620 000	2 010 000	1 700	2 200	950	*22240CAME4	*22240CAMKE4	218	—	342	315	3	0.26	3.8	2.6	2.5	42.6
	360	128	4	2 070 000	2 750 000	1 100	1 800	750	*23240CAME4	*23240CAMKE4	218	—	342	307	3	0.35	2.9	1.9	1.9	57.1
	360	128	4	1 660 000	2 750 000	1 000	—	750	23240CE4	23240CKE4	218	237	342	307	3	0.34	2.9	2.0	1.9	57.1
	420	138	5	2 500 000	2 990 000	1 100	1 700	850	*22340CAME4	*22340CAMKE4	222	—	398	352	4	0.34	2.9	2.0	1.9	92.6
220	300	60	2.1	785 000	1 240 000	2 200	2 600	1 000	*23944CAME4	*23944CAMKE4	232	—	288	278	2	0.18	5.7	3.8	3.7	12.2
	340	90	3	1 360 000	1 980 000	1 600	2 200	950	*23044CAME4	*23044CAMKE4	234	—	326	302	2.5	0.24	4.1	2.8	2.7	29.7
	340	118	3	1 640 000	2 490 000	1 200	1 900	750	*24044CAME4	*24044CAMK30E4	234	—	326	296	2.5	0.32	3.2	2.1	2.1	40.5
	340	118	3	1 360 000	2 600 000	1 100	—	750	24044CE4	24044CK30E4	234	244	326	296	2.5	0.31	3.2	2.1	2.1	40.5
	370	120	4	1 960 000	2 710 000	1 300	1 800	710	*23144CAME4	*23144CAMKE4	238	—	352	320	3	0.31	3.3	2.2	2.2	53
	370	120	4	1 570 000	2 710 000	1 100	—	710	23144CE4	23144CKE4	238	254	352	320	3	0.30	3.3	2.2	2.2	53
	370	150	4	2 250 000	3 200 000	850	1 600	710	*24144CAME4	*24144CAMK30E4	238	—	352	313	3	0.39	2.6	1.7	1.7	66.7
	370	150	4	1 800 000	3 200 000	750	—	710	24144CE4	24144CK30E4	238	248	352	313	3	0.39	2.6	1.7	1.7	66.7
	400	108	4	1 960 000	2 430 000	1 500	2 000	850	*22244CAME4	*22244CAMKE4	238	—	382	348	3	0.27	3.7	2.5	2.4	59
	400	144	4	2 520 000	3 400 000	1 000	1 600	670	*23244CAME4	*23244CAMKE4	238	—	382	337	3	0.36	2.8	1.9	1.8	80.4
	400	144	4	2 020 000	3 400 000	850	—	670	23244CE4	23244CKE4	238	260	382	337	3	0.35	2.9	1.9	1.9	80.4
	460	145	5	2 940 000	3 400 000	950	1 600	750	*22344CAME4	*22344CAMKE4	242	—	438	391	4	0.33	3.0	2.0	2.0	116

Note (1) Suffixes K and K30 represent bearings with tapered bores (taper 1:12 or 1:30).

Remarks 1. Bearings denoted by an asterisk (*) are NSKHPS bearings; they come standard with an oil groove and holes.
 2. The recommended fits (shaft tolerances) on Page A164 are different when selecting NSKHPS bearings. In this case, light loads are defined as $\leq 0.05C_r$ normal loads as 0.05 to 0.10 C_r , and heavy loads as $> 0.10C_r$.
 3. For the dimensions of adapters and withdrawal sleeves, refer to Pages C353 and C359.

SPHERICAL ROLLER BEARINGS

Bore Diameter 240 – 280 mm

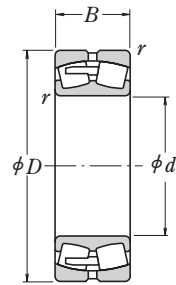

Cylindrical Bore

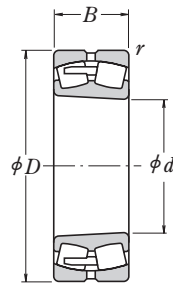

Tapered Bore



Without an Oil Groove and Holes

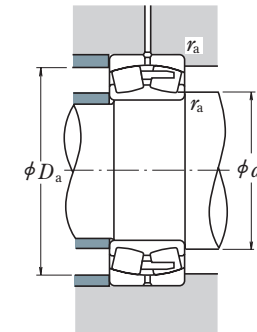

Dynamic Equivalent Load

$$P = XF_r + YF_a$$

$F_a/F_r \leq e$		$F_a/F_r > e$	
X	Y	X	Y
1	Y_3	0.67	Y_2

Static Equivalent Load

$$P_0 = F_r + Y_0 F_a$$

The values of e , Y_2 , Y_3 , and Y_0 are given in the table below.

Boundary Dimensions (mm)				Basic Load Ratings (N)		Thermal Reference Speed	Speeds (min ⁻¹)		Bearing Designations	Abutment and Fillet Dimensions (mm)					Constant e	Axial Load Factors			Mass (kg) approx.		
d	D	B	r min.	C_r	C_{0r}		Limiting Speeds			Cylindrical Bore	Tapered Bore ⁽¹⁾	d_a		D_a		r_a max.	Y_2	Y_3		Y_0	
							Mechanical	Grease				min.	max.	min.							max.
240	320	60	2.1	795 000	1 300 000	1 900	2 600	950	*23948CAME4	*23948CAMKE4	252	—	308	298	2	0.17	6.0	4.0	3.9	13.3	
	360	92	3	1 450 000	2 140 000	1 500	2 200	850	*23048CAME4	*23048CAMKE4	254	—	346	324	2.5	0.24	4.2	2.8	2.7	32.6	
	360	118	3	1 730 000	2 730 000	1 100	1 800	710	*24048CAME4	*24048CAMK30E4	254	—	346	317	2.5	0.30	3.4	2.3	2.2	43.4	
	360	118	3	1 390 000	2 730 000	1 000	—	710	24048CE4	24048CK30E4	254	265	346	317	2.5	0.29	3.4	2.3	2.2	43.4	
	400	128	4	2 230 000	3 100 000	1 200	1 700	670	*23148CAME4	*23148CAMKE4	258	—	382	347	3	0.31	3.3	2.2	2.2	66.9	
	400	128	4	1 790 000	3 100 000	1 000	—	670	23148CE4	23148CKE4	258	275	382	347	3	0.30	3.3	2.2	2.2	66.9	
	400	160	4	2 660 000	3 800 000	750	1 500	670	*24148CAME4	*24148CAMK30E4	258	—	382	341	3	0.38	2.7	1.8	1.8	79.5	
	400	160	4	2 130 000	3 800 000	670	—	670	24148CE4	24148CK30E4	258	268	382	341	3	0.38	2.7	1.8	1.8	79.5	
	440	120	4	2 340 000	2 890 000	1 400	1 800	750	*22248CAME4	*22248CAMKE4	258	—	422	383	3	0.27	3.7	2.5	2.4	80.2	
	440	160	4	3 050 000	4 050 000	850	1 500	630	*23248CAME4	*23248CAMKE4	258	—	422	372	3	0.37	2.7	1.8	1.8	106	
	500	155	5	3 250 000	3 800 000	850	1 500	670	*22348CAME4	*22348CAMKE4	262	—	478	423	4	0.32	3.2	2.1	2.1	147	
	260	360	75	2.1	1 170 000	1 870 000	1 800	2 200	850	*23952CAME4	*23952CAMKE4	272	—	348	333	2	0.19	5.4	3.6	3.5	23
400		104	4	1 780 000	2 580 000	1 300	1 900	800	*23052CAME4	*23052CAMKE4	278	—	382	356	3	0.25	4.1	2.7	2.7	46.6	
400		140	4	2 270 000	3 500 000	950	1 600	630	*24052CAME4	*24052CAMK30E4	278	—	382	348	3	0.32	3.1	2.1	2.1	62.6	
440		144	4	2 700 000	3 750 000	1 100	1 500	600	*23152CAME4	*23152CAMKE4	278	—	422	380	3	0.32	3.2	2.1	2.1	88.2	
440		180	4	3 200 000	4 700 000	630	1 300	600	*24152CAME4	*24152CAMK30E4	278	—	422	371	3	0.39	2.6	1.7	1.7	109	
480		130	5	2 720 000	3 400 000	1 200	1 700	670	*22252CAME4	*22252CAMKE4	282	—	458	418	4	0.27	3.7	2.5	2.5	104	
480		174	5	3 400 000	4 550 000	800	1 400	560	*23252CAME4	*23252CAMKE4	282	—	458	406	4	0.37	2.7	1.8	1.8	137	
540		165	6	3 900 000	4 600 000	750	1 400	630	*22352CAME4	*22352CAMKE4	288	—	512	462	5	0.32	3.2	2.1	2.1	180	
280		380	75	2.1	1 160 000	1 950 000	1 600	2 000	800	*23956CAME4	*23956CAMKE4	292	—	368	351	2	0.18	5.7	3.8	3.8	24.5
		420	106	4	1 930 000	2 950 000	1 200	1 800	710	*23056CAME4	*23056CAMKE4	298	—	402	377	3	0.24	4.2	2.8	2.7	50.5
		420	140	4	2 350 000	3 800 000	850	1 500	600	*24056CAME4	*24056CAMK30E4	298	—	402	369	3	0.31	3.3	2.2	2.2	66.4
		460	146	5	2 790 000	4 000 000	1 000	1 500	560	*23156CAME4	*23156CAMKE4	302	—	438	400	4	0.30	3.3	2.2	2.2	94.3
	460	180	5	3 300 000	5 000 000	600	1 300	560	*24156CAME4	*24156CAMK30E4	302	—	438	392	4	0.37	2.7	1.8	1.8	115	
	500	130	5	2 850 000	3 650 000	1 100	1 600	630	*22256CAME4	*22256CAMKE4	302	—	478	439	4	0.25	4.0	2.7	2.6	110	
	500	176	5	3 600 000	4 900 000	750	1 300	530	*23256CAME4	*23256CAMKE4	302	—	478	425	4	0.35	2.9	1.9	1.9	147	
	580	175	6	4 350 000	5 150 000	670	1 300	560	*22356CAME4	*22356CAMKE4	308	—	552	496	5	0.31	3.2	2.1	2.1	221	

Note (1) Suffixes K and K30 represent bearings with tapered bores (taper 1:12 or 1:30).

Remarks 1. Bearings denoted by an asterisk (*) are NSKHPS bearings; they come standard with an oil groove and holes.
 2. The recommended fits (shaft tolerances) on Page A164 are different when selecting NSKHPS bearings. In this case, light loads are defined as $\leq 0.05C_r$ normal loads as 0.05 to 0.10 C_r , and heavy loads as $> 0.10C_r$.
 3. For the dimensions of adapters and withdrawal sleeves, refer to Pages C353 and C359.

SPHERICAL ROLLER BEARINGS

Bore Diameter 300 – 380 mm

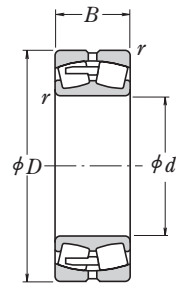

Cylindrical Bore

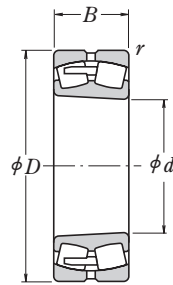

Tapered Bore



Without an Oil Groove and Holes

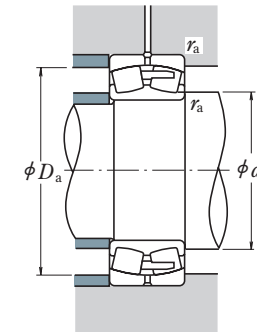

Dynamic Equivalent Load

$$P = XF_r + YF_a$$

$F_a/F_r \leq e$		$F_a/F_r > e$	
X	Y	X	Y
1	Y_3	0.67	Y_2

Static Equivalent Load

$$P_0 = F_r + Y_0 F_a$$

The values of e , Y_2 , Y_3 , and Y_0 are given in the table below.

Boundary Dimensions (mm)				Basic Load Ratings (N)		Thermal Reference Speed	Speeds (min ⁻¹)		Bearing Designations	Abutment and Fillet Dimensions (mm)					Constant e	Axial Load Factors			Mass (kg) approx.			
d	D	B	$r_{min.}$	C_r	C_{0r}		Limiting Speeds			Cylindrical Bore	Tapered Bore ⁽¹⁾	d_a min.	d_a max.	D_a min.		D_a max.	r_a min.	r_a max.		Y_2	Y_3	Y_0
							Mechanical	Grease														
300	420	90	3	1 540 000	2 490 000	1 500	1 800	710	*23960CAME4	*23960CAMKE4	314	—	406	386	2.5	0.19	5.2	3.5	3.4	38.2		
	460	118	4	2 400 000	3 700 000	1 100	1 600	670	*23060CAME4	*23060CAMKE4	318	—	442	413	3	0.24	4.2	2.8	2.7	70.5		
	460	160	4	2 890 000	4 600 000	800	1 400	530	*24060CAMK30E4	*24060CAMK30E4	318	—	442	400	3	0.32	3.1	2.1	2.0	93.6		
	500	160	5	3 350 000	4 800 000	900	1 400	500	*23160CAME4	*23160CAMKE4	322	—	478	433	4	0.31	3.3	2.2	2.2	125		
	500	200	5	3 900 000	5 800 000	530	1 200	500	*24160CAME4	*24160CAMK30E4	322	—	478	423	4	0.38	2.6	1.8	1.7	152		
	540	140	5	3 250 000	4 250 000	1 000	1 500	600	*22260CAME4	*22260CAMKE4	322	—	518	473	4	0.25	4.0	2.7	2.6	139		
540	192	5	4 250 000	5 900 000	670	1 200	480	*23260CAME4	*23260CAMKE4	322	—	518	458	4	0.35	2.9	1.9	1.9	189			
320	440	90	3	1 620 000	2 750 000	1 400	1 700	670	*23964CAME4	*23964CAMKE4	334	—	426	406	2.5	0.18	5.5	3.7	3.6	40.6		
	480	121	4	2 450 000	3 850 000	1 000	1 600	630	*23064CAME4	*23064CAMKE4	338	—	462	432	3	0.24	4.2	2.8	2.8	75.6		
	480	160	4	3 050 000	5 050 000	710	1 300	500	*24064CAME4	*24064CAMK30E4	338	—	462	422	3	0.31	3.3	2.2	2.2	99.7		
	540	176	5	3 850 000	5 500 000	800	1 300	480	*23164CAME4	*23164CAMKE4	342	—	518	466	4	0.31	3.2	2.1	2.1	162		
	540	218	5	4 400 000	6 650 000	480	1 100	480	*24164CAME4	*24164CAMK30E4	342	—	518	456	4	0.39	2.6	1.7	1.7	196		
	580	150	5	3 750 000	4 850 000	950	1 400	530	*22264CAME4	*22264CAMKE4	342	—	558	508	4	0.26	3.9	2.6	2.6	174		
580	208	5	4 850 000	6 900 000	600	1 100	450	*23264CAME4	*23264CAMKE4	342	—	558	488	4	0.36	2.8	1.9	1.8	239			
340	460	90	3	1 670 000	2 840 000	1 300	1 700	630	*23968CAME4	*23968CAMKE4	354	—	446	427	2.5	0.18	5.7	3.8	3.7	42.4		
	520	133	5	2 850 000	4 400 000	950	1 500	560	*23068CAME4	*23068CAMKE4	362	—	498	465	4	0.24	4.2	2.8	2.8	101		
	520	180	5	3 650 000	6 050 000	670	1 200	480	*24068CAME4	*24068CAMK30E4	362	—	498	454	4	0.32	3.2	2.1	2.1	135		
	580	190	5	4 500 000	6 600 000	710	1 200	430	*23168CAME4	*23168CAMKE4	362	—	558	499	4	0.31	3.2	2.1	2.1	206		
	580	243	5	5 300 000	7 900 000	450	1 000	430	*24168CAME4	*24168CAMK30E4	362	—	558	489	4	0.40	2.5	1.7	1.7	257		
	620	224	6	4 400 000	7 800 000	480	—	400	*23268CAME4	*23268CAMKE4	368	—	592	521	5	0.36	2.8	1.9	1.8	295		
360	480	90	3	1 730 000	3 050 000	1 200	1 700	600	*23972CAME4	*23972CAMKE4	374	—	466	447	2.5	0.17	6.0	4.1	4.0	44.7		
	540	134	5	2 990 000	4 700 000	900	1 400	530	*23072CAME4	*23072CAMKE4	382	—	518	485	4	0.24	4.2	2.8	2.8	106		
	540	180	5	3 650 000	6 100 000	630	1 200	450	*24072CAME4	*24072CAMK30E4	382	—	518	476	4	0.32	3.2	2.1	2.1	139		
	600	192	5	4 800 000	7 100 000	670	1 100	400	*23172CAME4	*23172CAMKE4	382	—	578	520	4	0.31	3.2	2.2	2.1	217		
	600	243	5	5 250 000	8 000 000	430	1 000	400	*24172CAME4	*24172CAMK30E4	382	—	578	507	4	0.40	2.5	1.7	1.7	264		
	650	232	6	4 800 000	8 550 000	450	—	380	*23272CAME4	*23272CAMKE4	388	—	622	549	5	0.36	2.8	1.9	1.8	342		
380	520	106	4	2 340 000	4 100 000	1 100	1 500	530	*23976CAME4	*23976CAMKE4	398	—	502	482	3	0.18	5.5	3.7	3.6	65.4		
	560	135	5	3 150 000	5 100 000	850	1 400	530	*23076CAME4	*23076CAMKE4	402	—	538	506	4	0.22	4.5	3.0	3.0	113		
	560	180	5	3 850 000	6 600 000	600	1 200	430	*24076CAME4	*24076CAMK30E4	402	—	538	496	4	0.29	3.4	2.3	2.3	148		
	620	194	5	4 000 000	7 600 000	530	—	400	*23176CAME4	*23176CAMKE4	402	—	598	540	4	0.30	3.3	2.2	2.2	229		
	620	243	5	4 350 000	8 450 000	360	—	400	*24176CAME4	*24176CAMK30E4	402	—	598	529	4	0.38	2.6	1.8	1.7	275		
	680	240	6	5 150 000	9 200 000	430	—	360	*23276CAME4	*23276CAMKE4	408	—	652	578	5	0.35	2.9	1.9	1.9	372		

Note (1) Suffixes K and K30 represent bearings with tapered bores (taper 1:12 or 1:30).

Remarks 1. Bearings denoted by an asterisk (*) are NSKHPS bearings; they come standard with an oil groove and holes.
 2. The recommended fits (shaft tolerances) on Page A164 are different when selecting NSKHPS bearings. In this case, light loads are defined as $\leq 0.05C_r$ normal loads as 0.05 to 0.10 C_r , and heavy loads as $> 0.10C_r$.
 3. For the dimensions of adapters and withdrawal sleeves, refer to Pages C354 and C360.

SPHERICAL ROLLER BEARINGS

Bore Diameter 400 – 460 mm

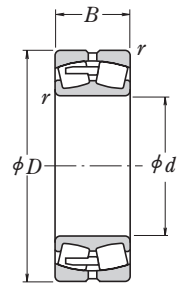

Cylindrical Bore

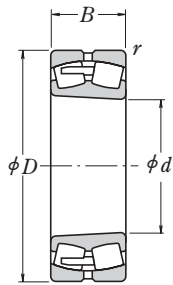

Tapered Bore



Without an Oil Groove and Holes

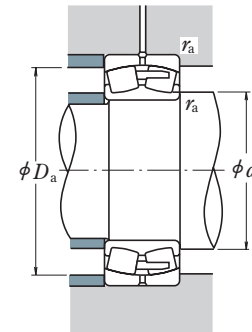

Dynamic Equivalent Load

$$P = XF_r + YF_a$$

$F_a/F_r \leq e$		$F_a/F_r > e$	
X	Y	X	Y
1	Y_3	0.67	Y_2

Static Equivalent Load

$$P_0 = F_r + Y_0 F_a$$

The values of e , Y_2 , Y_3 , and Y_0 are given in the table below.

Boundary Dimensions (mm)				Basic Load Ratings (N)		Thermal Reference Speed	Speeds (min ⁻¹)		Bearing Designations	Abutment and Fillet Dimensions (mm)					Constant e	Axial Load Factors			Mass (kg) approx.	
d	D	B	r min.	C_r	C_{0r}		Mechanical	Grease		Cylindrical Bore	Tapered Bore ⁽¹⁾	d_a		D_a		r_a max.	Y_2	Y_3		Y_0
														min.	max.				min.	
400	540	106	4	2 370 000	4 250 000	1 000	1 400	530	*23980CAME4	*23980CAMKE4	418	—	522	501	3	0.18	5.7	3.9	3.8	69.1
	600	148	5	3 700 000	5 900 000	800	1 300	480	*23080CAME4	*23080CAMKE4	422	—	578	540	4	0.23	4.4	3.0	2.9	146
	600	200	5	4 500 000	7 600 000	560	1 100	400	*24080CAME4	*24080CAMK30E4	422	—	578	527	4	0.31	3.3	2.2	2.2	193
	650	200	6	4 150 000	7 900 000	500	—	380	23180CAME4	23180CAMKE4	428	—	622	569	5	0.29	3.4	2.3	2.3	257
	650	250	6	4 950 000	10 100 000	320	—	380	24180CAME4	24180CAMK30E4	428	—	622	551	5	0.37	2.7	1.8	1.8	316
	720	256	6	5 800 000	10 400 000	380	—	340	23280CAME4	23280CAMKE4	428	—	692	610	5	0.36	2.8	1.9	1.9	449
420	560	106	4	2 340 000	4 250 000	1 000	1 400	500	*23984CAME4	*23984CAMKE4	438	—	542	521	3	0.17	6.0	4.0	3.9	71.6
	620	150	5	2 910 000	5 850 000	670	—	450	23084CAME4	23084CAMKE4	442	—	598	562	4	0.23	4.3	2.9	2.8	151
	620	200	5	3 750 000	8 100 000	480	—	380	24084CAME4	24084CAMK30E4	442	—	598	549	4	0.31	3.2	2.2	2.1	199
700	224	6	5 000 000	9 400 000	480	—	340	23184CAME4	23184CAMKE4	448	—	672	607	5	0.31	3.3	2.2	2.2	341	
	280	6	6 000 000	12 000 000	280	—	340	24184CAME4	24184CAMK30E4	448	—	672	598	5	0.38	2.6	1.8	1.7	421	
	272	7.5	6 450 000	11 700 000	360	—	320	23284CAME4	23284CAMKE4	456	—	724	644	6	0.35	2.9	1.9	1.9	534	
440	600	118	4	2 190 000	4 800 000	630	—	450	23988CAME4	23988CAMKE4	458	—	582	555	3	0.18	5.7	3.9	3.8	96.3
	650	157	6	3 150 000	6 350 000	630	—	430	23088CAME4	23088CAMKE4	468	—	622	587	5	0.23	4.3	2.9	2.8	173
	650	212	6	4 150 000	9 100 000	450	—	360	24088CAME4	24088CAMK30E4	468	—	622	576	5	0.31	3.2	2.1	2.1	237
720	226	6	5 300 000	10 300 000	430	—	320	23188CAME4	23188CAMKE4	468	—	692	627	5	0.3	3.3	2.2	2.2	360	
	280	6	6 000 000	12 100 000	280	—	320	24188CAME4	24188CAMK30E4	468	—	692	617	5	0.37	2.7	1.8	1.8	433	
	280	7.5	6 900 000	12 800 000	340	—	300	23288CAME4	23288CAMKE4	476	—	754	669	6	0.35	2.9	1.9	1.9	594	
460	620	118	4	2 220 000	4 950 000	600	—	430	23992CAME4	23992CAMKE4	478	—	602	575	3	0.17	5.9	4.0	3.9	100
	680	163	6	3 450 000	7 100 000	600	—	400	23092CAME4	23092CAMKE4	488	—	652	615	5	0.22	4.6	3.1	3.0	201
	680	218	6	4 500 000	9 950 000	430	—	340	24092CAME4	24092CAMK30E4	488	—	652	604	5	0.29	3.4	2.3	2.3	266
760	240	7.5	5 700 000	10 900 000	430	—	300	23192CAME4	23192CAMKE4	496	—	724	661	6	0.31	3.3	2.2	2.2	423	
	300	7.5	6 300 000	12 400 000	280	—	300	24192CAME4	24192CAMK30E4	496	—	724	646	6	0.39	2.6	1.7	1.7	512	
	296	7.5	7 350 000	13 700 000	320	—	280	23292CAME4	23292CAMKE4	496	—	794	702	6	0.37	2.8	1.9	1.8	691	

Note (1) Suffixes K and K30 represent bearings with tapered bores (taper 1:12 or 1:30).

Remarks 1. Bearings denoted by an asterisk (*) are NSKHPS bearings; they come standard with an oil groove and holes.
 2. The recommended fits (shaft tolerances) on Page A164 are different when selecting NSKHPS bearings. In this case, light loads are defined as $\leq 0.05C_r$ normal loads as 0.05 to 0.10 C_r , and heavy loads as $> 0.10C_r$.
 3. For the dimensions of adapters and withdrawal sleeves, refer to Pages C354 – C355 and C360 – C361.

SPHERICAL ROLLER BEARINGS

Bore Diameter 480 – 560 mm

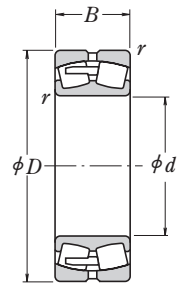

Cylindrical Bore

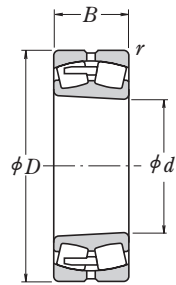

Tapered Bore



Without an Oil Groove and Holes

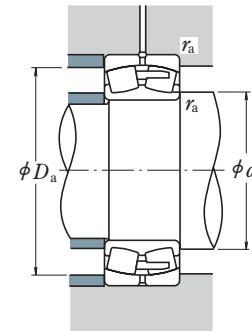

Dynamic Equivalent Load

$$P = XF_r + YF_a$$

$F_a/F_r \leq e$		$F_a/F_r > e$	
X	Y	X	Y
1	Y_3	0.67	Y_2

Static Equivalent Load

$$P_0 = F_r + Y_0 F_a$$

The values of e , Y_2 , Y_3 , and Y_0 are given in the table below.

Boundary Dimensions (mm)				Basic Load Ratings (N)		Thermal Reference Speed	Speeds (min ⁻¹)		Bearing Designations	Abutment and Fillet Dimensions (mm)					Constant e	Axial Load Factors			Mass (kg) approx.		
d	D	B	r min.	C_r	C_{0r}		Mechanical	Grease		Cylindrical Bore	Tapered Bore ⁽¹⁾		d_a			D_a	r_a	Y_2		Y_3	Y_0
											min.	max.	max.	min.	max.						
480	650	128	5	2 580 000	5 850 000	560	—	400	23996CAME4 23096CAME4 24096CAME4	23996CAMKE4 23096CAMKE4 24096CAMK30E4	502	—	628	602	4	0.18	5.7	3.8	3.7	121	
	700	165	6	3 800 000	7 950 000	560	—	400			508	—	672	633	5	0.22	4.6	3.1	3.0	211	
	700	218	6	4 600 000	10 200 000	400	—	320			508	—	672	625	5	0.30	3.4	2.3	2.2	270	
		790	248	7.5	6 050 000	11 700 000	400	—	300	23196CAME4 24196CAME4 23296CAME4	23196CAMKE4 24196CAMK30E4 23296CAMKE4	516	—	754	688	6	0.31	3.3	2.2	2.2	475
		790	308	7.5	7 150 000	14 600 000	240	—	300			516	—	754	670	6	0.39	2.6	1.7	1.7	567
		870	310	7.5	7 850 000	14 400 000	300	—	260			516	—	834	733	6	0.37	2.8	1.9	1.8	795
	500	670	128	5	2 460 000	5 550 000	560	—	400	239/500CAME4 230/500CAME4 240/500CAME4	239/500CAMKE4 230/500CAMKE4 240/500CAMK30E4	522	—	648	622	4	0.17	6.0	4.0	3.9	124
		720	167	6	3 750 000	8 100 000	530	—	380			528	—	692	655	5	0.21	4.8	3.2	3.1	220
		720	218	6	4 450 000	9 900 000	400	—	300			528	—	692	643	5	0.30	3.4	2.3	2.2	276
830	830	264	7.5	6 850 000	13 400 000	360	—	280	231/500CAME4 241/500CAME4 232/500CAME4	231/500CAMKE4 241/500CAMK30E4 232/500CAMKE4	536	—	794	720	6	0.31	3.2	2.2	2.1	567	
	830	325	7.5	8 000 000	16 000 000	220	—	280			536	—	794	703	6	0.39	2.6	1.7	1.7	666	
	920	336	7.5	9 000 000	16 600 000	280	—	260			536	—	884	773	6	0.38	2.7	1.8	1.8	969	
530	710	136	5	2 930 000	6 800 000	500	—	360	239/530CAME4 230/530CAME4 240/530CAME4	239/530CAMKE4 230/530CAMKE4 240/530CAMK30E4	552	—	688	659	4	0.17	6.0	4.0	3.9	149	
	780	185	6	4 400 000	9 200 000	500	—	340			558	—	752	706	5	0.22	4.6	3.1	3.0	298	
	780	250	6	5 400 000	11 800 000	360	—	280			558	—	752	690	5	0.31	3.3	2.2	2.2	390	
		870	272	7.5	7 150 000	14 100 000	340	—	260	231/530CAME4 241/530CAME4 232/530CAME4	231/530CAMKE4 241/530CAMK30E4 232/530CAMKE4	566	—	834	758	6	0.30	3.3	2.2	2.2	628
	870	335	7.5	8 500 000	17 500 000	200	—	260	566			—	834	740	6	0.38	2.6	1.8	1.7	773	
	980	355	9.5	10 100 000	18 800 000	260	—	240	574	—	936	824	8	0.38	2.7	1.8	1.7	1 170			
560	750	140	5	3 100 000	7 250 000	480	—	340	239/560CAME4 230/560CAME4 240/560CAME4	239/560CAMKE4 230/560CAMKE4 240/560CAMK30E4	582	—	728	697	4	0.16	6.1	4.1	4.0	172	
	820	195	6	5 000 000	10 700 000	450	—	320			588	—	792	742	5	0.22	4.5	3.0	2.9	344	
	820	258	6	5 950 000	13 300 000	340	—	260			588	—	792	729	5	0.30	3.3	2.2	2.2	440	
		920	280	7.5	7 850 000	15 500 000	320	—	240	231/560CAME4 241/560CAME4 232/560CAME4	231/560CAMKE4 241/560CAMK30E4 232/560CAMKE4	596	—	884	804	6	0.30	3.4	2.3	2.2	727
	920	355	7.5	9 400 000	19 600 000	190	—	240	596			—	884	782	6	0.39	2.6	1.8	1.7	886	
	1 030	365	9.5	10 900 000	20 500 000	240	—	220	604	—	986	870	8	0.36	2.8	1.9	1.8	1 320			

Note (1) Suffixes K and K30 represent bearings with tapered bores (taper 1:12 or 1:30).

Remark For the dimensions of adapters and withdrawal sleeves, refer to Pages C355 and C361.

SPHERICAL ROLLER BEARINGS

Bore Diameter 600 – 750 mm

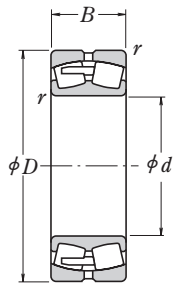

Cylindrical Bore

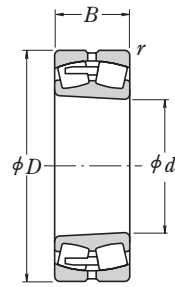

Tapered Bore

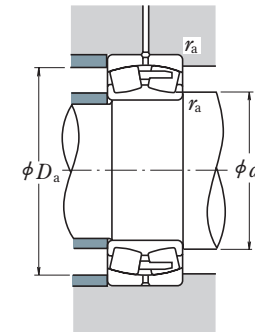

Dynamic Equivalent Load

$$P = XF_r + YF_a$$

$F_a/F_r \leq e$		$F_a/F_r > e$	
X	Y	X	Y
1	Y_3	0.67	Y_2

Static Equivalent Load

$$P_0 = F_r + Y_0 F_a$$

The values of e , Y_2 , Y_3 , and Y_0 are given in the table below.

Boundary Dimensions (mm)				Basic Load Ratings (N)		Thermal Reference Speed	Speeds (min ⁻¹)		Bearing Designations	Abutment and Fillet Dimensions (mm)					Constant e	Axial Load Factors			Mass (kg) approx.	
d	D	B	r min.	C_r	C_{0r}		Limiting Speeds Mechanical	Grease		Cylindrical Bore	Tapered Bore ⁽¹⁾	d_a min.	d_a max.	D_a min.		D_a max.	r_a min.	r_a max.		Y_2
600	800	150	5	3 450 000	8 100 000	450			—	320	239/600CAME4	239/600CAMKE4	622	—	778	745	4	0.17	5.9	3.9
	870	200	6	5 450 000	12 200 000	400	—	300	230/600CAME4	230/600CAMKE4	628	—	842	794	5	0.21	4.8	3.3	3.2	389
	870	272	6	6 600 000	15 100 000	300	—	240	240/600CAME4	240/600CAMK30E4	628	—	842	772	5	0.30	3.3	2.2	2.2	529
	980	300	7.5	8 750 000	17 500 000	280	—	220	231/600CAME4	231/600CAMKE4	636	—	944	856	6	0.30	3.4	2.3	2.2	898
	980	375	7.5	10 400 000	21 900 000	170	—	220	241/600CAME4	241/600CAMK30E4	636	—	944	836	6	0.39	2.6	1.8	1.7	1 050
	1 090	388	9.5	12 700 000	24 900 000	200	—	200	232/600CAME4	232/600CAMKE4	644	—	1 046	923	8	0.36	2.8	1.9	1.8	1 590
630	850	165	6	4 000 000	9 350 000	400	—	300	239/630CAME4	239/630CAMKE4	658	—	822	786	5	0.18	5.6	3.8	3.7	259
	920	212	7.5	5 900 000	12 700 000	400	—	280	230/630CAME4	230/630CAMKE4	666	—	884	835	6	0.22	4.7	3.1	3.1	468
	920	290	7.5	7 550 000	17 700 000	280	—	220	240/630CAME4	240/630CAMK30E4	666	—	884	815	6	0.30	3.3	2.2	2.2	637
	1 030	315	7.5	9 600 000	19 400 000	260	—	200	231/630CAME4	231/630CAMKE4	666	—	994	900	6	0.30	3.4	2.3	2.2	1 040
	1 030	400	7.5	11 300 000	23 900 000	160	—	200	241/630CAME4	241/630CAMK30E4	666	—	994	876	6	0.38	2.7	1.8	1.7	1 250
	1 150	412	12	13 400 000	25 600 000	200	—	180	232/630CAME4	232/630CAMKE4	684	—	1 096	970	10	0.37	2.8	1.9	1.8	1 850
670	900	170	6	4 350 000	10 300 000	380	—	260	239/670CAME4	239/670CAMKE4	698	—	872	836	5	0.17	5.8	3.9	3.8	300
	980	230	7.5	6 850 000	15 000 000	360	—	240	230/670CAME4	230/670CAMKE4	706	—	944	891	6	0.22	4.7	3.1	3.1	571
	980	308	7.5	8 450 000	19 500 000	260	—	200	240/670CAME4	240/670CAMK30E4	706	—	944	868	6	0.30	3.3	2.2	2.2	773
	1 090	336	7.5	10 600 000	21 600 000	240	—	190	231/670CAME4	231/670CAMKE4	706	—	1 054	952	6	0.30	3.3	2.2	2.2	1 230
	1 090	412	7.5	12 400 000	26 500 000	150	—	190	241/670CAME4	241/670CAMK30E4	706	—	1 054	934	6	0.37	2.7	1.8	1.8	1 440
	1 220	438	12	14 900 000	28 700 000	180	—	170	232/670CAME4	232/670CAMKE4	724	—	1 166	1 024	10	0.37	2.7	1.8	1.8	2 210
710	950	180	6	4 800 000	11 700 000	360	—	240	239/710CAME4	239/710CAMKE4	738	—	922	883	5	0.17	5.8	3.9	3.8	352
	1 030	236	7.5	7 100 000	15 800 000	340	—	240	230/710CAME4	230/710CAMKE4	746	—	994	936	6	0.22	4.6	3.1	3.0	647
	1 030	315	7.5	8 850 000	20 700 000	240	—	190	240/710CAME4	240/710CAMK30E4	746	—	994	916	6	0.29	3.4	2.3	2.2	861
	1 150	438	9.5	13 900 000	30 500 000	130	—	170	241/710CAME4	241/710CAMK30E4	754	—	1 106	981	8	0.38	2.6	1.8	1.7	1 730
	1 280	450	12	15 700 000	30 500 000	170	—	160	232/710CAME4	232/710CAMKE4	764	—	1 226	1 080	10	0.36	2.8	1.9	1.8	2 470
750	1 000	185	6	5 250 000	12 800 000	320	—	220	239/750CAME4	239/750CAMKE4	778	—	972	931	5	0.17	6.0	4.1	4.0	398
	1 090	250	7.5	7 750 000	17 200 000	320	—	220	230/750CAME4	230/750CAMKE4	786	—	1 054	990	6	0.22	4.6	3.1	3.0	768
	1 090	335	7.5	10 100 000	24 000 000	220	—	180	240/750CAME4	240/750CAMK30E4	786	—	1 054	969	6	0.29	3.4	2.3	2.2	1 030
	1 360	475	15	17 700 000	35 500 000	150	—	140	232/750CAME4	232/750CAMKE4	814	—	1 296	1 148	12	0.36	2.8	1.9	1.8	2 980

Note ⁽¹⁾ Suffixes K and K30 represent bearings with tapered bores (taper 1:12 or 1:30).

SPHERICAL ROLLER BEARINGS

Bore Diameter 800 – 1400 mm

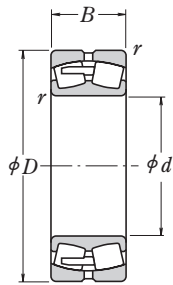

Cylindrical Bore

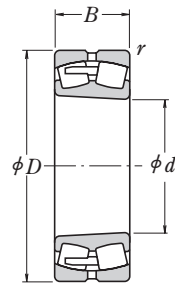

Tapered Bore

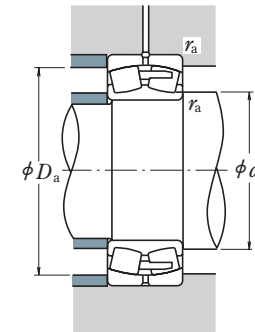

Dynamic Equivalent Load

$$P = XF_r + YF_a$$

$F_a/F_r \leq e$		$F_a/F_r > e$	
X	Y	X	Y
1	Y_3	0.67	Y_2

Static Equivalent Load

$$P_0 = F_r + Y_0 F_a$$

The values of e , Y_2 , Y_3 , and Y_0 are given in the table below.

Boundary Dimensions (mm)	Basic Load Ratings (N)		Thermal Reference Speed	Speeds (min ⁻¹)		Bearing Designations	Abutment and Fillet Dimensions (mm)				Constant e	Axial Load Factors			Mass (kg)						
							d	D	B	r min.		C_r	C_{0r}	Cylindrical Bore		Tapered Bore ⁽¹⁾		Y_2	Y_3	Y_0	
														Limiting Speeds Mechanical		Grease	d_a min.				d_a max.
800	1 060	195	6	5 600 000	13 700 000	300	—	220	239/800CAME4	239/800CAMKE4	828	—	1 032	987	5	0.17	6.0	4.0	3.9	462	
	1 150	258	7.5	8 350 000	19 100 000	300	—	200	230/800CAME4	230/800CAMKE4	836	—	1 114	1 045	6	0.21	4.7	3.2	3.1	870	
	1 150	345	7.5	10 900 000	26 300 000	200	—	160	240/800CAME4	240/800CAMK30E4	836	—	1 114	1 029	6	0.27	3.7	2.5	2.5	1 130	
	1 280	375	9.5	13 800 000	29 200 000	190	—	150	231/800CAME4	231/800CAMKE4	844	—	1 236	1 127	8	0.28	3.6	2.4	2.3	1 870	
	1 420	488	15	20 300 000	41 000 000	130	—	130	232/800CAME4	232/800CAMKE4	864	—	1 356	1 208	12	0.35	2.8	1.9	1.9	3 250	
850	1 120	200	6	6 100 000	15 200 000	280	—	190	239/850CAME4	239/850CAMKE4	878	—	1 092	1 046	5	0.16	6.2	4.2	4.1	523	
	1 220	272	7.5	9 300 000	21 400 000	280	—	180	230/850CAME4	230/850CAMKE4	886	—	1 184	1 109	6	0.21	4.8	3.2	3.1	1 020	
	1 220	365	7.5	11 600 000	28 300 000	190	—	150	240/850CAME4	240/850CAMK30E4	886	—	1 184	1 093	6	0.28	3.6	2.4	2.4	1 350	
	1 500	515	15	22 300 000	45 500 000	120	—	120	232/850CAME4	232/850CAMKE4	914	—	1 436	1 274	12	0.35	2.8	1.9	1.9	3 890	
900	1 180	206	6	6 600 000	16 700 000	260	—	180	239/900CAME4	239/900CAMKE4	928	—	1 152	1 103	5	0.16	6.4	4.3	4.2	591	
	1 280	280	7.5	9 850 000	22 800 000	260	—	160	230/900CAME4	230/900CAMKE4	936	—	1 244	1 169	6	0.20	4.9	3.3	3.2	1 160	
	1 280	375	7.5	12 800 000	31 500 000	170	—	140	240/900CAME4	240/900CAMK30E4	936	—	1 244	1 147	6	0.28	3.6	2.4	2.4	1 520	
	1 580	515	15	23 400 000	47 500 000	120	—	110	232/900CAME4	232/900CAMKE4	964	—	1 516	1 354	12	0.33	3.0	2.0	2.0	4 300	
950	1 250	224	7.5	7 600 000	19 900 000	240	—	160	239/950CAME4	239/950CAMKE4	986	—	1 214	1 169	6	0.16	6.3	4.2	4.1	732	
	1 360	300	7.5	11 300 000	26 500 000	240	—	150	230/950CAME4	230/950CAMKE4	986	—	1 324	1 241	6	0.21	4.8	3.2	3.2	1 400	
	1 360	412	7.5	14 500 000	36 500 000	160	—	120	240/950CAME4	240/950CAMK30E4	986	—	1 324	1 219	6	0.28	3.6	2.4	2.3	1 880	
	1 660	530	15	24 700 000	50 500 000	110	—	100	232/950CAME4	232/950CAMKE4	1 014	—	1 596	1 428	12	0.32	3.1	2.1	2.1	4 800	
1 000	1 320	236	7.5	8 200 000	21 700 000	220	—	150	239/1000CAME4	239/1000CAMKE4	1 036	—	1 284	1 229	6	0.16	6.4	4.3	4.2	881	
	1 420	308	7.5	11 900 000	28 100 000	220	—	140	230/1000CAME4	230/1000CAMKE4	1 036	—	1 384	1 298	6	0.20	4.9	3.3	3.2	1 560	
	1 420	412	7.5	15 300 000	38 500 000	150	—	110	240/1000CAME4	240/1000CAMK30E4	1 036	—	1 384	1 275	6	0.27	3.7	2.5	2.4	2 010	
1 060	1 400	250	7.5	9 300 000	24 400 000	200	—	130	239/1060CAME4	239/1060CAMKE4	1 096	—	1 364	1 302	6	0.16	6.1	4.1	4.0	1 030	
	1 500	325	9.5	13 000 000	31 500 000	200	—	120	230/1060CAME4	230/1060CAMKE4	1 104	—	1 456	1 368	8	0.21	4.9	3.3	3.2	1 790	
	1 500	438	9.5	16 800 000	43 000 000	140	—	100	240/1060CAME4	240/1060CAMK30E4	1 104	—	1 456	1 346	8	0.28	3.6	2.4	2.4	2 410	
1 120	1 580	345	9.5	15 400 000	38 000 000	180	—	110	230/1120CAME4	230/1120CAMKE4	1 164	—	1 536	1 444	8	0.20	5.0	3.4	3.3	2 120	
	1 580	462	9.5	18 700 000	49 500 000	120	—	95	240/1120CAME4	240/1120CAMK30E4	1 164	—	1 536	1 421	8	0.27	3.7	2.5	2.5	2 790	
1 180	1 660	475	9.5	20 200 000	52 500 000	120	—	85	240/1180CAME4	240/1180CAMK30E4	1 224	—	1 616	1 494	8	0.27	3.7	2.5	2.4	3 180	
1 250	1 750	500	9.5	21 000 000	59 500 000	110	—	75	240/1250CAME4	240/1250CAMK30E4	1 294	—	1 706	1 579	8	0.25	4.0	2.7	2.6	3 700	
1 320	1 850	530	12	22 600 000	63 500 000	100	—	67	240/1320CAME4	240/1320CAMK30E4	1 374	—	1 796	1 656	10	0.26	3.9	2.6	2.6	4 400	
1 400	1 950	545	12	24 500 000	65 000 000	95	—	60	240/1400CAME4	240/1400CAMK30E4	1 454	—	1 896	1 767	10	0.25	4.0	2.7	2.6	4 900	

Note ⁽¹⁾ Suffixes K and K30 represent bearings with tapered bores (taper 1:12 or 1:30).

8. THRUST BALL BEARINGS

INTRODUCTION C 296

BEARING TABLES

SINGLE-DIRECTION THRUST BALL BARINGS

With Flat Seat, Aligning Seat, or Aligning Seat Washer
 Bore Diameter 10 – 360 mm C 298

DOUBLE-DIRECTION THRUST BALL BEARINGS

With Flat Seat, Aligning Seat, or Aligning Seat Washer
 Bore Diameter 10 – 190 mm C 306



DESIGN, TYPES, AND FEATURES

THRUST BALL BEARINGS

Thrust ball bearings are classified into those with flat seats or aligning seats, depending on the shape of the outer ring seat (housing washer). They can sustain axial loads but no radial loads.

Available Series of thrust ball bearings available are shown in Table 1.

For single-direction thrust ball bearings, pressed-steel cages and machined-brass cages are usually used as shown in Table 2. The cages in double-direction thrust ball bearings are the same as those in single-direction thrust ball bearings of the same Diameter Series.

The basic load ratings listed in the bearing tables are based on the standard cage type shown in Table 2. If the type of cage is different for bearings with the same number, the number of balls may vary; in such cases, the load rating will differ from that listed in the bearing tables.

Table 1 Series of Thrust Ball Bearings

	W/Flat Seat	W/Aligning Seat	W/Aligning Seat Washer
Single-Direction	511	—	—
	512	532	532U
	513	533	533U
	514	534	534U
Double-Direction	522	542	542U
	523	543	543U
	524	544	544U

Table 2 Standard Cages for Thrust Ball Bearings

Pressed Steel	Machined Brass
51100 – 51152X	51156X – 51172X
51200 – 51236X	51238X – 51272X
51305 – 51336X	51338X – 51340X
51405 – 51418X	51420X – 51436X
53200 – 53236X	53238X – 53272X
53305 – 53336X	53338X – 53340X
53405 – 53418X	53420X – 53436X

MINIMUM AXIAL LOAD

Be sure to apply some axial load to thrust bearings to prevent slippage between the rolling elements and raceways. For more details, please refer to Page A198.

TOLERANCES AND RUNNING ACCURACY

THRUST BALL BEARINGS Table 7.6 (Pages A140 to A142)

RECOMMENDED FITS

THRUST BALL BEARINGS Table 8.4 (Pages A164)
 Table 8.6 (Pages A165)

■ SINGLE-DIRECTION THRUST BALL BEARINGS

Bore Diameter 10 – 50 mm

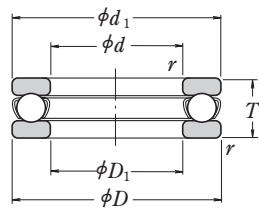

With Flat Seat

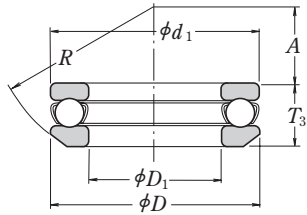

With Aligning Seat

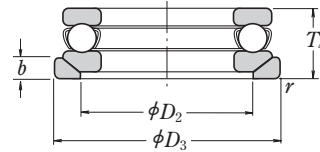

With Aligning Seat Washer

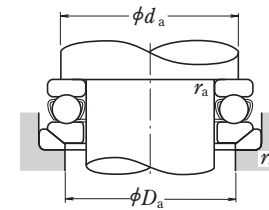
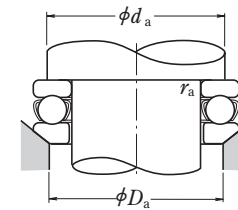
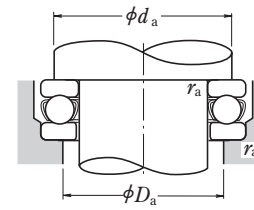

d	Boundary Dimensions (mm)					Basic Load Ratings (N)		Limiting Speeds (min ⁻¹)		Bearing	Designations		Dimensions (mm)						Abutment and Fillet Dimensions (mm)			Mass(kg) approx.				
	D	T	T ₃	T ₄	r min.	C _a	C _{0a}	Grease	Oil		With Flat Seat	With Aligning Seat	With Aligning Seat Washer	d ₁	D ₁	D ₂	D ₃	b	A	R	d _a min.	D _a max.	r _a max.	With Flat Seat	With Aligning Seat	With Aligning Seat Washer
10	24	9	—	—	0.3	10 100	14 000	6 700	10 000	51100	—	—	24	11	—	—	—	—	—	18	16	0.3	0.019	—	—	
	26	11	11.6	13	0.6	12 800	17 100	6 000	9 000		51200	53200	53200 U	26	12	18	28	3.5	8.5	22	20	16	0.6	0.028	0.029	0.036
12	26	9	—	—	0.3	10 400	15 400	6 700	10 000	51101	—	—	26	13	—	—	—	—	20	18	0.3	0.021	—	—		
	28	11	11.4	13	0.6	13 300	19 000	5 600	8 500		51201	53201	53201 U	28	14	20	30	3.5	11.5	25	22	18	0.6	0.031	0.031	0.039
15	28	9	—	—	0.3	10 600	16 800	6 300	9 500	51102	—	—	28	16	—	—	—	—	23	20	0.3	0.023	—	—		
	32	12	13.3	15	0.6	16 700	24 800	5 000	7 500		51202	53202	53202 U	32	17	24	35	4	12	28	25	22	0.6	0.043	0.048	0.059
17	30	9	—	—	0.3	11 400	19 500	6 000	9 000	51103	—	—	30	18	—	—	—	—	25	22	0.3	0.025	—	—		
	35	12	13.2	15	0.6	17 300	27 300	4 800	7 500		51203	53203	53203 U	35	19	26	38	4	16	32	28	24	0.6	0.050	0.055	0.069
20	35	10	—	—	0.3	15 100	26 600	5 300	8 000	51104	—	—	35	21	—	—	—	—	29	26	0.3	0.037	—	—		
	40	14	14.7	17	0.6	22 500	37 500	4 300	6 300		51204	53204	53204 U	40	22	30	42	5	18	36	32	28	0.6	0.077	0.080	0.096
25	42	11	—	—	0.6	19 700	37 000	4 800	7 100	51105	—	—	42	26	—	—	—	—	35	32	0.6	0.056	—	—		
	47	15	16.7	19	0.6	28 000	50 500	3 800	5 600		51205	53205	53205 U	47	27	36	50	5.5	19	40	38	34	0.6	0.111	0.123	0.151
	52	18	19.8	22	1	36 000	61 500	3 200	5 000		51305	53305	53305 U	52	27	38	55	6	21	45	41	36	1	0.169	0.182	0.224
	60	24	26.4	29	1	56 000	89 500	2 600	4 000		51405	53405	53405 U	60	27	42	62	8	19	50	46	39	1	0.334	0.353	0.426
30	47	11	—	—	0.6	20 600	42 000	4 300	6 700	51106	—	—	47	32	—	—	—	—	40	37	0.6	0.064	—	—		
	52	16	17.8	20	0.6	29 500	58 000	3 400	5 300		51206	53206	53206 U	52	32	42	55	5.5	22	45	43	39	0.6	0.137	0.154	0.183
	60	21	22.6	25	1	43 000	78 500	2 800	4 300		51306	53306	53306 U	60	32	45	62	7	22	50	48	42	1	0.267	0.28	0.336
	70	28	30.1	33	1	73 000	126 000	2 200	3 400		51406	53406	53406 U	70	32	50	75	9	20	56	54	46	1	0.519	0.535	0.666
35	52	12	—	—	0.6	22 100	49 500	4 000	6 000	51107	—	—	52	37	—	—	—	—	45	42	0.6	0.081	—	—		
	62	18	19.9	22	1	39 500	78 000	3 000	4 500		51207	53207	53207 U	62	37	48	65	7	24	50	51	46	1	0.21	0.231	0.292
	68	24	25.6	28	1	56 000	105 000	2 400	3 800		51307	53307	53307 U	68	37	52	72	7.5	24	56	55	48	1	0.386	0.403	0.488
	80	32	34	37	1.1	87 500	155 000	2 000	3 000		51407	53407	53407 U	80	37	58	85	10	23	64	62	53	1	0.769	0.785	0.967
40	60	13	—	—	0.6	27 100	63 000	3 600	5 300	51108	—	—	60	42	—	—	—	—	52	48	0.6	0.12	—	—		
	68	19	20.3	23	1	47 500	98 500	2 800	4 300		51208	53208	53208 U	68	42	55	72	7	28.5	56	57	51	1	0.27	0.289	0.355
	78	26	28.5	31	1	70 000	135 000	2 200	3 400		51308	53308	53308 U	78	42	60	82	8.5	28	64	63	55	1	0.536	0.581	0.704
	90	36	38.2	42	1.1	103 000	188 000	1 700	2 600		51408	53408	53408 U	90	42	65	95	12	26	72	70	60	1	1.1	1.12	1.38
45	65	14	—	—	0.6	28 100	69 000	3 400	5 000	51109	—	—	65	47	—	—	—	—	57	53	0.6	0.143	—	—		
	73	20	21.3	24	1	48 000	105 000	2 600	4 000		51209	53209	53209 U	73	47	60	78	7.5	26	56	62	56	1	0.31	0.333	0.419
	85	28	30.1	33	1	80 500	163 000	2 000	3 000		51309	53309	53309 U	85	47	65	90	10	25	64	69	61	1	0.672	0.702	0.888
	100	39	42.4	46	1.1	128 000	246 000	1 600	2 400		51409	53409	53409 U	100	47	72	105	12.5	29	80	78	67	1	1.46	1.53	1.87
50	70	14	—	—	0.6	29 000	75 500	3 200	4 800	51110	—	—	70	52	—	—	—	—	62	58	0.6	0.153	—	—		
	78	22	23.5	26	1	49 000	111 000	2 400	3 600		51210	53210	53210 U	78	52	62	82	7.5	32.5	64	67	61	1	0.378	0.404	0.504
	95	31	34.3	37	1.1	97 500	202 000	1 800	2 800		51310	53310	53310 U	95	52	72	100	11	28	72	77	68	1	0.931	1.01	1.27
	110	43	45.6	50	1.5	147 000	288 000	1 400	2 200		51410	53410	53410 U	110	52	80	115	14	35	90	86	74	1.5	1.94	1.98	2.41

■ SINGLE-DIRECTION THRUST BALL BEARINGS

Bore Diameter 55 – 100 mm

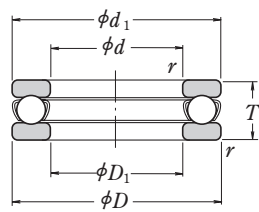

With Flat Seat

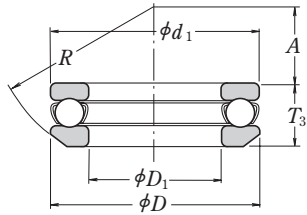

With Aligning Seat

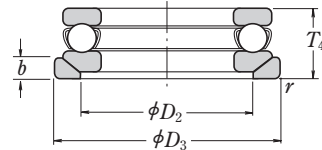

With Aligning Seat Washer

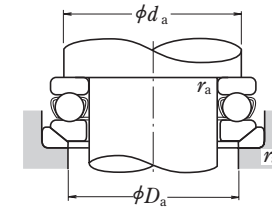
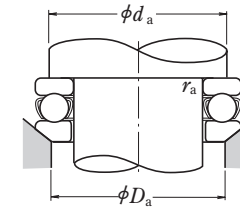
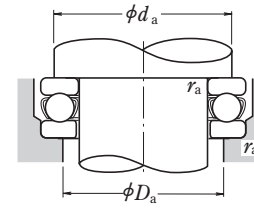

Boundary Dimensions (mm)						Basic Load Ratings (N)		Limiting Speeds (min ⁻¹)		Bearing	Designations ⁽¹⁾		Dimensions (mm)						Abutment and Fillet Dimensions (mm)			Mass(kg) approx.				
d	D	T	T ₃	T ₄	r min.	C _a	C _{0a}	Grease	Oil		With Flat Seat	With Aligning Seat	With Aligning Seat Washer	d ₁	D ₁	D ₂	D ₃	b	A	R	d _a min.	D _a max.	r _a max.	With Flat Seat	With Aligning Seat	With Aligning Seat Washer
55	78	16	—	—	0.6	35 000	93 000	2 800	4 300	51111	—	—	78	57	—	—	—	—	—	—	69	64	0.6	0.227	—	—
	90	25	27.3	30	1	70 000	159 000	2 200	3 200	51211	53211	53211 U	90	57	72	95	9	35	72	76	69	1	0.599	0.656	0.819	
	105	35	39.3	42	1.1	115 000	244 000	1 600	2 400	51311	53311	53311 U	105	57	80	110	11.5	30	80	85	75	1	1.31	1.45	1.78	
	120	48	50.5	55	1.5	181 000	350 000	1 300	1 900	51411	53411	53411 U	120	57	88	125	15.5	28	90	94	81	1.5	2.58	2.59	3.16	
60	85	17	—	—	1	41 500	113 000	2 600	4 000	51112	—	—	85	62	—	—	—	—	—	75	70	1	0.281	—	—	
	95	26	28	31	1	71 500	169 000	2 000	3 000	51212	53212	53212 U	95	62	78	100	9	32.5	72	81	74	1	0.673	0.731	0.897	
	110	35	38.3	42	1.1	119 000	263 000	1 600	2 400	51312	53312	53312 U	110	62	85	115	11.5	41	90	90	80	1	1.4	1.51	1.83	
	130	51	54	58	1.5	202 000	395 000	1 200	1 800	51412	53412	53412 U	130	62	95	135	16	34	100	102	88	1.5	3.16	3.2	3.91	
65	90	18	—	—	1	42 000	117 000	2 400	3 800	51113	—	—	90	67	—	—	—	—	—	80	75	1	0.324	—	—	
	100	27	28.7	32	1	75 500	189 000	1 900	2 800	51213	53213	53213 U	100	67	82	105	9	40	80	86	79	1	0.756	0.812	0.989	
	115	36	39.4	43	1.1	123 000	282 000	1 500	2 400	51313	53313	53313 U	115	67	90	120	12.5	38.5	90	95	85	1	1.54	1.67	2.04	
	140	56	60.2	65	2	234 000	495 000	1 100	1 700	51413	53413	53413 U	140	68	100	145	17.5	40	112	110	95	2	4.1	4.22	5.13	
70	95	18	—	—	1	43 500	127 000	2 400	3 600	51114	—	—	95	72	—	—	—	—	—	85	80	1	0.346	—	—	
	105	27	28.8	32	1	74 000	189 000	1 900	2 800	51214	53214	53214 U	105	72	88	110	9	38	80	91	84	1	0.793	0.866	1.05	
	125	40	44.2	48	1.1	137 000	315 000	1 400	2 000	51314	53314	53314 U	125	72	98	130	13	43	100	103	92	1	2.0	2.2	2.64	
	150	60	63.6	69	2	252 000	555 000	1 000	1 500	51414	53414	53414 U	150	73	110	155	19.5	34	112	118	102	2	5.05	5.12	6.21	
75	100	19	—	—	1	43 500	131 000	2 200	3 400	51115	—	—	100	77	—	—	—	—	—	90	85	1	0.389	—	—	
	110	27	28.3	32	1	78 000	209 000	1 800	2 800	51215	53215	53215 U	110	77	92	115	9.5	49	90	96	89	1	0.845	1.27	1.11	
	135	44	48.1	52	1.5	159 000	365 000	1 300	1 900	51315	53315	53315 U	135	77	105	140	15	37	100	111	99	1.5	2.6	2.8	3.42	
	160	65	69	75	2	254 000	560 000	950	1 400	51415	53415	53415 U	160	78	115	165	21	42	125	125	110	2	6.15	6.23	7.58	
80	105	19	—	—	1	45 000	141 000	2 200	3 400	51116	—	—	105	82	—	—	—	—	—	95	90	1	0.417	—	—	
	115	28	29.5	33	1	79 000	218 000	1 800	2 600	51216	53216	53216 U	115	82	98	120	10	46	90	101	94	1	0.931	1.01	1.23	
	140	44	47.6	52	1.5	164 000	395 000	1 300	1 900	51316	53316	53316 U	140	82	110	145	15	50	112	116	104	1.5	2.74	2.94	3.55	
	170	68	72.2	78	2.1	272 000	620 000	900	1 300	51416	53416	53416 U	170	83	125	175	22	36	125	133	117	2	7.21	7.33	8.9	
85	110	19	—	—	1	46 500	150 000	2 200	3 200	51117	—	—	110	87	—	—	—	—	—	100	95	1	0.44	—	—	
	125	31	33.1	37	1	96 000	264 000	1 600	2 400	51217	53217	53217 U	125	88	105	130	11	52	100	109	101	1	1.22	1.35	1.63	
	150	49	53.1	58	1.5	207 000	490 000	1 100	1 700	51317	53317	53317 U	150	88	115	155	17.5	43	112	124	111	1.5	3.57	3.78	4.67	
	180	72	77	83	2.1	310 000	755 000	850	1 300	51417 X	53417 X	53417 XU	177	88	130	185	23	47	140	141	124	2	8.51	8.72	10.4	
90	120	22	—	—	1	60 000	190 000	1 900	3 000	51118	—	—	120	92	—	—	—	—	—	108	102	1	0.646	—	—	
	135	35	38.5	42	1.1	114 000	310 000	1 400	2 200	51218	53218	53218 U	135	93	110	140	13.5	45	100	117	108	1	1.69	1.89	2.38	
	155	50	54.6	59	1.5	214 000	525 000	1 100	1 700	51318	53318	53318 U	155	93	120	160	18	40	112	129	116	1.5	3.83	4.11	5.09	
	190	77	81.2	88	2.1	330 000	825 000	800	1 200	51418 X	53418 X	53418 XU	187	93	140	195	25.5	40	140	149	131	2	10.2	10.3	12.4	
100	135	25	—	—	1	86 000	268 000	1 700	2 600	51120	—	—	135	102	—	—	—	—	—	121	114	1	0.96	—	—	
	150	38	40.9	45	1.1	135 000	375 000	1 300	2 000	51220	53220	53220 U	150	103	125	155	14	52	112	130	120	1	2.25	2.49	3.03	
	170	55	59.2	64	1.5	239 000	595 000	1 000	1 500	51320	53320	53320 U	170	103	135	175	18	46	125	142	128	1.5	4.98	5.31	6.37	
	210	85	90	98	3	370 000	985 000	710	1 100	51420 X	53420 X	53420 XU	205	103	155	220	27	50	160	165	145	2.5	14.8	15	18.1	

Note ⁽¹⁾ The outside diameter d_1 of shaft washers for bearing designations with an X is smaller than the outside diameter D of the housing washers.

■ SINGLE-DIRECTION THRUST BALL BEARINGS

Bore Diameter 110 – 190 mm

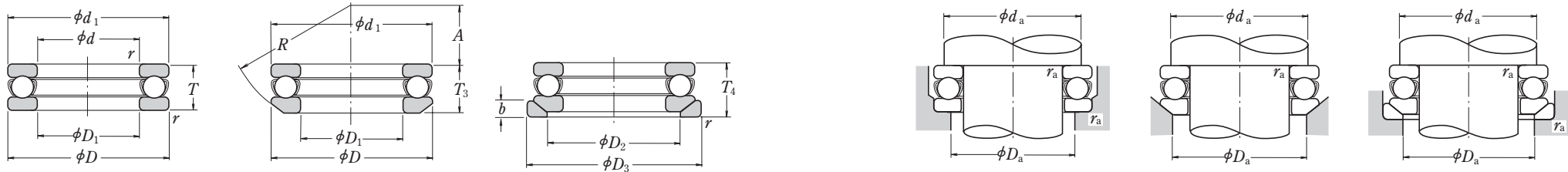

With Flat Seat

With Aligning Seat

With Aligning Seat Washer

d	Boundary Dimensions (mm)					Basic Load Ratings (N)		Limiting Speeds (min ⁻¹)		Bearing	Designations ⁽¹⁾		Dimensions (mm)						Abutment and Fillet Dimensions (mm)			Mass(kg) approx.				
	D	T	T ₃	T ₄	r min.	C _a	C _{0a}	Grease	Oil		With Flat Seat	With Aligning Seat	With Aligning Seat Washer	d ₁	D ₁	D ₂	D ₃	b	A	R	d _a min.	D _a max.	r _a max.	With Flat Seat	With Aligning Seat	With Aligning Seat Washer
110	145	25	—	—	1	88 000	288 000	1 700	2 400	51122	—	—	145	112	—	—	—	—	—	—	131	124	1	1.04	—	—
	160	38	40.2	45	1.1	136 000	395 000	1 300	1 900	51222	53222	53222 U	160	113	135	165	14	65	125	140	130	1	2.42	2.65	3.2	
	190	63	67.2	72	2	282 000	755 000	900	1 300	51322 X	53322 X	53322 XU	187	113	150	195	20.5	51	140	158	142	2	7.19	7.55	9.1	
	230	95	99.7	109	3	415 000	1 150 000	630	950	51422 X	53422 X	53422 XU	225	113	170	240	29	59	180	181	159	2.5	20	20.5	24.3	
120	155	25	—	—	1	90 000	310 000	1 600	2 400	51124	—	—	155	122	—	—	—	—	—	—	141	134	1	1.12	—	—
	170	39	40.8	46	1.1	141 000	430 000	1 200	1 800	51224	53224	53224 U	170	123	145	175	15	61	125	150	140	1	2.7	2.94	3.58	
	210	70	74.1	80	2.1	330 000	930 000	800	1 200	51324 X	53324 X	53324 XU	205	123	165	220	22	63	160	173	157	2	9.7	10.1	12.4	
	250	102	107.3	118	4	480 000	1 400 000	600	900	51424 X	53424 X	53424 XU	245	123	185	260	32	70	200	196	174	3	26.2	26.5	31.3	
130	170	30	—	—	1	105 000	350 000	1 400	2 000	51126	—	—	170	132	—	—	—	—	—	—	154	146	1	1.68	—	—
	190	45	47.9	53	1.5	183 000	550 000	1 100	1 600	51226 X	53226 X	53226 XU	187	133	160	195	17	67	140	166	154	1.5	3.95	4.35	5.33	
	225	75	80.3	86	2.1	350 000	1 030 000	750	1 100	51326 X	53326 X	53326 XU	220	134	177	235	26	53	160	186	169	2	12.1	12.7	15.8	
	270	110	115.2	128	4	525 000	1 590 000	530	800	51426 X	53426 X	53426 XU	265	134	200	280	38	58	200	212	188	3	32.3	32.4	38.8	
140	180	31	—	—	1	107 000	375 000	1 300	2 000	51128 X	—	—	178	142	—	—	—	—	—	—	164	156	1	1.83	—	—
	200	46	48.6	55	1.5	186 000	575 000	1 000	1 500	51228 X	53228 X	53228 XU	197	143	170	210	17	87	160	176	164	1.5	4.3	4.74	5.89	
	240	80	84.9	92	2.1	370 000	1 130 000	670	1 000	51328 X	53328 X	53328 XU	235	144	190	250	26	68	180	199	181	2	14.2	16.3	19.5	
	280	112	117	131	4	550 000	1 750 000	530	800	51428 X	53428 X	53428 XU	275	144	206	290	38	83	225	222	198	3	34.7	34.8	41.4	
150	190	31	—	—	1	110 000	400 000	1 300	1 900	51130 X	—	—	188	152	—	—	—	—	—	—	174	166	1	1.95	—	—
	215	50	53.3	60	1.5	238 000	735 000	950	1 400	51230 X	53230 X	53230 XU	212	153	180	225	20.5	79	160	189	176	1.5	5.52	6.09	7.82	
	250	80	83.7	92	2.1	380 000	1 200 000	670	1 000	51330 X	53330 X	53330 XU	245	154	200	260	26	89.5	200	209	191	2	15	17.3	20.5	
	300	120	125.9	140	4	620 000	2 010 000	480	710	51430 X	53430 X	53430 XU	295	154	225	310	41	69	225	238	212	3	43.5	43.8	51.9	
160	200	31	—	—	1	113 000	425 000	1 200	1 900	51132 X	—	—	198	162	—	—	—	—	—	—	184	176	1	2.07	—	—
	225	51	54.7	61	1.5	249 000	805 000	900	1 400	51232 X	53232 X	53232 XU	222	163	190	235	21	74	160	199	186	1.5	6.04	6.78	8.7	
	270	87	91.7	100	3	475 000	1 570 000	600	900	51332 X	53332 X	53332 XU	265	164	215	280	29	77	200	225	205	2.5	19.6	22.3	26.7	
	320	130	135.3	150	5	650 000	2 210 000	450	670	51432 X	53432 X	53432 XU	315	164	240	330	41.5	84	250	254	226	4	52.7	52.9	62	
170	215	34	—	—	1.1	135 000	510 000	1 100	1 700	51134 X	—	—	213	172	—	—	—	—	—	—	197	188	1	2.72	—	—
	240	55	58.7	65	1.5	280 000	915 000	850	1 300	51234 X	53234 X	53234 XU	237	173	200	250	21.5	91	180	212	198	1.5	7.41	8.21	10.5	
	280	87	91.3	100	3	465 000	1 570 000	600	900	51334 X	53334 X	53334 XU	275	174	220	290	29	105	225	235	215	2.5	20.3	23.2	28	
	340	135	141	156	5	715 000	2 480 000	430	630	51434 X	53434 X	53434 XU	335	174	255	350	46	74	250	269	241	4	61.2	61.3	73	
180	225	34	—	—	1.1	136 000	530 000	1 100	1 700	51136 X	—	—	222	183	—	—	—	—	—	—	207	198	1	2.79	—	—
	250	56	58.2	66	1.5	284 000	955 000	800	1 200	51236 X	53236 X	53236 XU	247	183	210	260	21.5	112	200	222	208	1.5	7.94	8.57	10.8	
	300	95	99.3	109	3	480 000	1 680 000	560	850	51336 X	53336 X	53336 XU	295	184	240	310	32	91	225	251	229	2.5	25.9	29.2	34.9	
	360	140	148.3	164	5	750 000	2 730 000	400	600	51436 X	53436 X	53436 XU	355	184	270	370	46.5	97	280	285	255	4	70.5	72.1	84.9	
190	240	37	—	—	1.1	172 000	655 000	1 000	1 600	51138 X	—	—	237	193	—	—	—	—	—	—	220	210	1	3.6	—	—
	270	62	65.7	73	2	320 000	1 110 000	750	1 100	51238 X	53238 X	53238 XU	267	194	230	280	23	98	200	238	222	2	11.8	12.9	15.7	
	320	105	111	121	4	550 000	1 960 000	500	750	51338 X	53338 X	53338 XU	315	195	255	330	33	104	250	266	244	3	36.5	38.1	44.7	

Note ⁽¹⁾ The outside diameter d_1 of shaft washers for bearing designations with an X is smaller than the outside diameter D of the housing washers.

SINGLE-DIRECTION THRUST BALL BEARINGS

Bore Diameter 200 – 360 mm

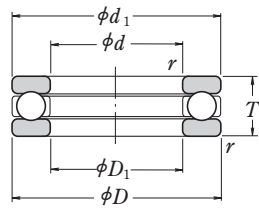

With Flat Seat

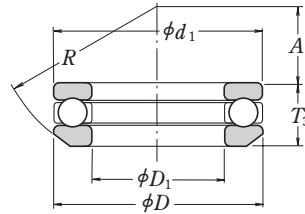

With Aligning Seat

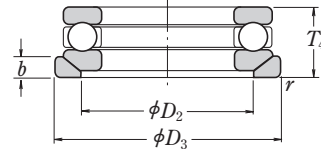

With Aligning Seat Washer

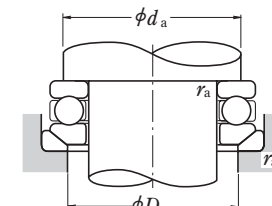
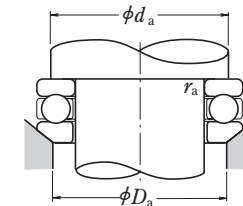
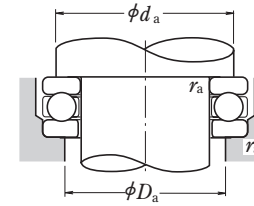

<i>d</i>	Boundary Dimensions (mm)					Basic Load Ratings (N)		Limiting Speeds (min ⁻¹)		Bearing With Flat Seat	Designations ⁽¹⁾		Dimensions (mm)						Abutment and Fillet Dimensions (mm)			Mass(kg) approx.		
	<i>D</i>	<i>T</i>	<i>T</i> ₃	<i>T</i> ₄	<i>r</i> _{min.}	<i>C</i> _a	<i>C</i> _{0a}	Grease	Oil		With Aligning Seat	With Aligning Seat Washer	<i>d</i> ₁	<i>D</i> ₁	<i>D</i> ₂	<i>D</i> ₃	<i>b</i>	<i>A</i>	<i>R</i>	<i>d</i> _a min.	<i>D</i> _a max.	<i>r</i> _a max.	With Flat Seat	With Aligning Seat
200	250	37	—	—	1.1	173 000	675 000	1 000	1 500	51140 X	—	247	203	—	—	—	—	—	230	220	1	3.75	—	—
	280	62	65.3	74	2	315 000	1 110 000	710	1 100	51240 X	53240 X	277	204	240	290	23	125	225	248	232	2	12.3	13.4	16.1
	340	110	118.4	130	4	600 000	2 220 000	480	710	51340 X	53340 X	335	205	270	350	38	92	250	282	258	3	43.6	46.2	54.8
220	270	37	—	—	1.1	179 000	740 000	950	1 500	51144 X	—	267	223	—	—	—	—	—	250	240	1	4.09	—	—
	300	63	65.6	75	2	325 000	1 210 000	670	1 000	51244 X	53244 X	297	224	260	310	25	118	225	268	252	2	13.6	14.9	18
240	300	45	—	—	1.5	229 000	935 000	850	1 200	51148 X	—	297	243	—	—	—	—	—	276	264	1.5	6.55	—	—
	340	78	81.6	92	2.1	420 000	1 650 000	560	850	51248 X	53248 X	335	244	290	350	30	122	250	299	281	2	23.7	25.6	30.7
260	320	45	—	—	1.5	233 000	990 000	800	1 200	51152 X	—	317	263	—	—	—	—	—	296	284	1.5	7.01	—	—
	360	79	82.8	93	2.1	435 000	1 800 000	560	850	51252 X	53252 X	355	264	305	370	30	152	280	319	301	2	25.1	27.3	33.2
280	350	53	—	—	1.5	315 000	1 310 000	710	1 000	51156 X	—	347	283	—	—	—	—	—	322	308	1.5	12	—	—
	380	80	85	94	2.1	450 000	1 950 000	530	800	51256 X	53256 X	375	284	325	390	31	143	280	339	321	2	27.1	30.3	37
300	380	62	—	—	2	360 000	1 560 000	600	900	51160 X	—	376	304	—	—	—	—	—	348	332	2	17.2	—	—
	420	95	100.5	112	3	540 000	2 410 000	450	670	51260 X	53260 X	415	304	360	430	34	164	320	371	349	2.5	43.5	47.7	56.1
320	400	63	—	—	2	365 000	1 660 000	600	900	51164 X	—	396	324	—	—	—	—	—	368	352	2	18.6	—	—
	440	95	100.5	112	3	585 000	2 680 000	450	670	51264 X	53264 X	435	325	380	450	36	157	320	391	369	2.5	45	49.9	59.4
340	420	64	—	—	2	375 000	1 760 000	560	850	51168 X	—	416	344	—	—	—	—	—	388	372	2	19.9	—	—
	460	96	100.3	113	3	595 000	2 800 000	430	630	51268 X	53268 X	455	345	400	470	36	199	360	411	389	2.5	47.9	52.7	62
360	440	65	—	—	2	385 000	1 860 000	560	800	51172 X	—	436	364	—	—	—	—	—	408	392	2	21.5	—	—
	500	110	116.7	130	4	705 000	3 500 000	380	560	51272 X	53272 X	495	365	430	510	43	172	360	442	418	3	68.8	76.3	90.9

Note ⁽¹⁾ The outside diameter *d*₁ of shaft washers for bearing designations with an X is smaller than the outside diameter *D* of the housing washers.

DOUBLE-DIRECTION THRUST BALL BEARINGS

Bore Diameter 10 – 55 mm

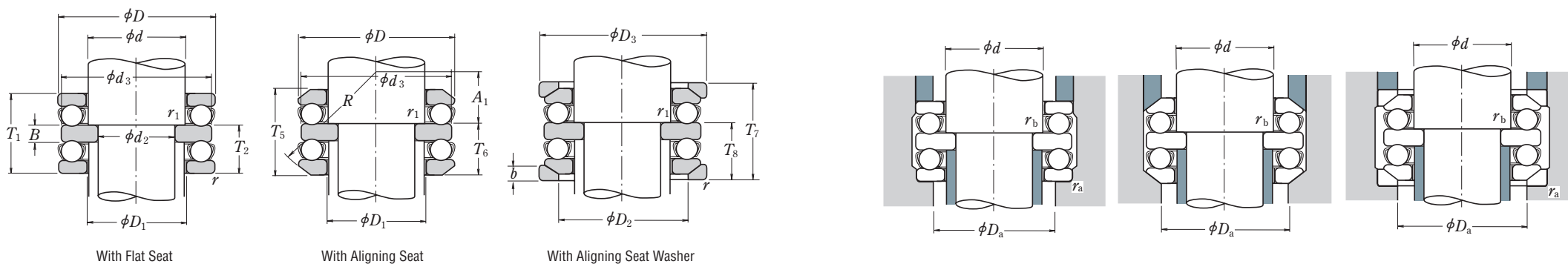

Boundary Dimensions (mm)								Basic Load Ratings (N)		Limiting Speeds (min ⁻¹)		Bearing		Designations	Dimensions (mm)											Abutment and Fillet Dimensions (mm)			Mass (kg) approx.		
d ₂	d	D	T ₁	T ₅	T ₇	r _{min.}	r _{1 min.}	C _a	C _{0a}	Grease	Oil	With Flat Seat	With Aligning Seat		With Aligning Seat Washer	d ₃	D ₁	D ₂	D ₃	T ₂	T ₆	T ₈	B	b	A ₁	R	D _a max.	r _a max.	r _b max.	With Flat Seat	With Aligning Seat
10	15	32	22	24.6	28	0.6	0.3	16 700	24 800	4 800	7 100	52202	54202	54202 U	32	17	24	35	13.5	14.8	16.5	5	4	10.5	28	24	0.6	0.3	0.081	0.090	0.113
15	20	40	26	27.4	32	0.6	0.3	22 500	37 500	4 000	6 000	52204	54204	54204 U	40	22	30	42	16	16.7	19	6	5	16	36	30	0.6	0.3	0.148	0.151	0.185
	25	60	45	49.8	55	1	0.6	56 000	89 500	2 400	3 600	52405	54405	54405 U	60	27	42	62	28	30.4	33	11	8	15	50	42	1	0.6	0.641	0.68	0.825
20	25	47	28	31.4	36	0.6	0.3	28 000	50 500	3 400	5 300	52205	54205	54205 U	47	27	36	50	17.5	19.2	21.5	7	5.5	16.5	40	36	0.6	0.3	0.213	0.236	0.293
	25	52	34	37.6	42	1	0.3	36 000	61 500	3 000	4 500	52305	54305	54305 U	52	27	38	55	21	22.8	25	8	6	18	45	38	1	0.3	0.324	0.35	0.434
	30	70	52	56.2	62	1	0.6	73 000	126 000	2 200	3 200	52406	54406	54406 U	70	32	50	75	32	34.1	37	12	9	16	56	50	1	0.6	0.978	1.01	1.27
25	30	52	29	32.6	37	0.6	0.3	29 500	58 000	3 200	5 000	52206	54206	54206 U	52	32	42	55	18	19.8	22	7	5.5	20	45	42	0.6	0.3	0.254	0.288	0.345
	30	60	38	41.2	46	1	0.3	43 000	78 500	2 600	4 000	52306	54306	54306 U	60	32	45	62	23.5	25.1	27.5	9	7	19.5	50	45	1	0.3	0.483	0.511	0.621
	35	80	59	63	69	1.1	0.6	87 500	155 000	1 800	2 800	52407	54407	54407 U	80	37	58	85	36.5	38.5	41.5	14	10	18.5	64	58	1	0.6	1.43	1.47	1.83
30	35	62	34	37.8	42	1	0.3	39 500	78 000	2 800	4 300	52207	54207	54207 U	62	37	48	65	21	22.9	25	8	7	21	50	48	1	0.3	0.406	0.447	0.57
	35	68	44	47.2	52	1	0.3	56 000	105 000	2 400	3 600	52307	54307	54307 U	68	37	52	72	27	28.6	31	10	7.5	21	56	52	1	0.3	0.71	0.744	0.915
	40	68	36	38.6	44	1	0.6	47 500	98 500	2 600	3 800	52208	54208	54208 U	68	42	55	72	22.5	23.8	26.5	9	7	25	56	55	1	0.6	0.543	0.581	0.713
40	78	49	54	59	1	0.6	70 000	135 000	2 000	3 000	52308	54308	54308 U	78	42	60	82	30.5	33	35.5	12	8.5	23.5	64	60	1	0.6	1.04	1.13	1.38	
	90	65	69.4	77	1.1	0.6	103 000	188 000	1 700	2 400	52408	54408	54408 U	90	42	65	95	40	42.2	46	15	12	22	72	65	1	0.6	1.98	2.02	2.54	
35	45	73	37	39.6	45	1	0.6	48 000	105 000	2 400	3 600	52209	54209	54209 U	73	47	60	78	23	24.3	27	9	7.5	23	56	60	1	0.6	0.606	0.652	0.823
	45	85	52	56.2	62	1	0.6	80 500	163 000	1 900	2 800	52309	54309	54309 U	85	47	65	90	32	34.1	37	12	10	21	64	65	1	0.6	1.28	1.34	1.71
40	45	100	72	78.8	86	1.1	0.6	128 000	246 000	1 500	2 200	52409	54409	54409 U	100	47	72	105	44.5	47.9	51.5	17	12.5	23.5	80	72	1	0.6	2.71	2.85	3.53
	50	78	39	42	47	1	0.6	49 000	111 000	2 400	3 400	52210	54210	54210 U	78	52	62	82	24	25.5	28	9	7.5	30.5	64	62	1	0.6	0.697	0.75	0.949
	50	95	58	64.6	70	1.1	0.6	97 500	202 000	1 700	2 600	52310	54310	54310 U	95	52	72	100	36	39.3	42	14	11	23	72	72	1	0.6	1.78	1.94	2.46
45	50	110	78	83.2	92	1.5	0.6	147 000	288 000	1 400	2 000	52410	54410	54410 U	110	52	80	115	48	50.6	55	18	14	30	90	80	1.5	0.6	3.51	3.59	4.45
	55	90	45	49.6	55	1	0.6	70 000	159 000	2 000	3 000	52211	54211	54211 U	90	57	72	95	27.5	29.8	32.5	10	9	32.5	72	72	1	0.6	1.11	1.22	1.55
	55	105	64	72.6	78	1.1	0.6	115 000	244 000	1 500	2 400	52311	54311	54311 U	105	57	80	110	39.5	43.8	46.5	15	11.5	25.5	80	80	1	0.6	2.43	2.7	3.35
50	55	120	87	92	101	1.5	0.6	181 000	350 000	1 200	1 800	52411	54411	54411 U	120	57	88	125	53.5	56	60.5	20	15.5	22.5	90	88	1.5	0.6	4.66	4.68	5.82
	60	95	46	50	56	1	0.6	71 500	169 000	1 900	3 000	52212	54212	54212 U	95	62	78	100	28	30	33	10	9	30.5	72	78	1	0.6	1.22	1.33	1.66
	60	110	64	70.6	78	1.1	0.6	119 000	263 000	1 500	2 200	52312	54312	54312 U	110	62	85	115	39.5	42.8	46.5	15	11.5	36.5	90	85	1	0.6	2.59	2.82	3.45
	60	130	93	99	107	1.5	0.6	202 000	395 000	1 100	1 700	52412	54412	54412 U	130	62	95	135	57	60	64	21	16	28	100	95	1.5	0.6	5.74	5.82	7.24
55	65	140	101	109.4	119	2	1	234 000	495 000	1 000	1 600	52413	54413	54413 U	140	68	100	145	62	66.2	71	23	17.5	34	112	100	2	1	7.41	7.66	9.47
	65	100	47	50.4	57	1	0.6	75 500	189 000	1 900	2 800	52213	54213	54213 U	100	67	82	105	28.5	30.2	33.5	10	9	38.5	80	82	1	0.6	1.34	1.45	1.81
	65	115	65	71.8	79	1.1	0.6	123 000	282 000	1 500	2 200	52313	54313	54313 U	115	67	90	120	40	43.4	47	15	12.5	34.5	90	90	1	0.6	2.8	3.06	3.8
	70	105	47	50.6	57	1	1	74 000	189 000	1 800	2 800	52214	54214	54214 U	105	72	88	110	28.5	30.3	33.5	10	9	36.5	80	88	1	1	1.44	1.59	1.95
	70	125	72	80.4	88	1.1	1	137 000	315 000	1 300	2 000	52314	54314	54314 U	125	72	98	130	44	48.2	52	16	13	39	100	98	1	1	3.67	4.07	4.95
70	150	107	114.2	125	2	1	252 000	555 000	1 000	1 500	52414	54414	54414 U	150	73	110	155	65.5	69.1	74.5	24	19.5	28.5	112	110	2	1	8.99	9.12	11.3	

DOUBLE-DIRECTION THRUST BALL BEARINGS

Bore Diameter 60 – 130 mm

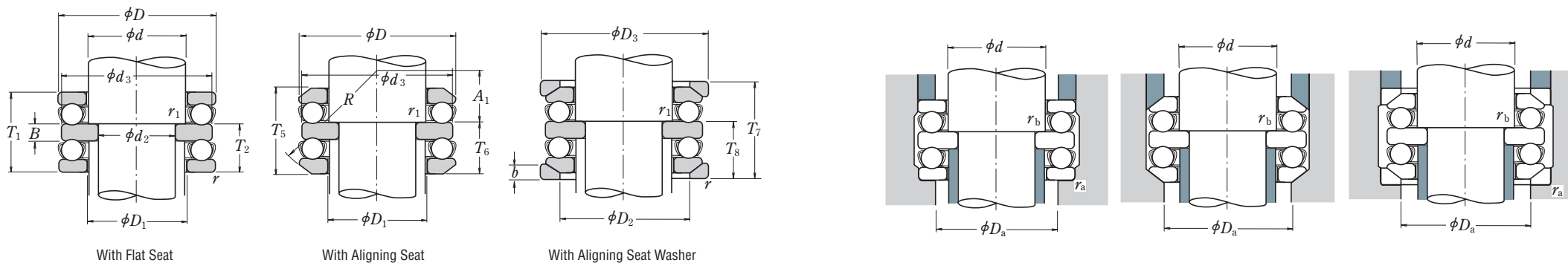

d ₂	Boundary Dimensions (mm)						Basic Load Ratings (N)		Limiting Speeds (min ⁻¹)		Bearing Designations ⁽¹⁾		With Aligning Seat Washer	Dimensions (mm)										Abutment and Fillet Dimensions (mm)			Mass (kg) approx.				
	d	D	T ₁	T ₅	T ₇	r min.	r ₁ min.	C _a	C _{0a}	Grease	Oil	With Flat Seat		With Aligning Seat	d ₃	D ₁	D ₂	D ₃	T ₂	T ₆	T ₈	B	b	A ₁	R	D _a max.	r _a max.	r _b max.	With Flat Seat	With Aligning Seat	With Aligning Seat Washer
60	75	110	47	49.6	57	1	1	78 000	209 000	1 800	2 600	52215	54215	54215 U	110	77	92	115	28.5	29.8	33.5	10	9.5	47.5	90	92	1	1	1.54	1.66	2.06
	75	135	79	87.2	95	1.5	1	159 000	365 000	1 200	1 800	52315	54315	54315 U	135	77	105	140	48.5	52.6	56.5	18	15	32.5	100	105	1.5	1	4.74	5.14	6.38
	75	160	115	123	135	2	1	254 000	560 000	900	1 400	52415	54415	54415 U	160	78	115	165	70.5	74.5	80.5	26	21	36.5	125	115	2	1	10.8	11	13.7
65	80	115	48	51	58	1	1	79 000	218 000	1 700	2 600	52216	54216	54216 U	115	82	98	120	29	30.5	34	10	10	45	90	98	1	1	1.66	1.78	2.21
	80	140	79	86.2	95	1.5	1	164 000	395 000	1 200	1 800	52316	54316	54316 U	140	82	110	145	48.5	52.1	56.5	18	15	45.5	112	110	1.5	1	4.99	5.39	6.61
	80	170	120	128.4	140	2.1	1	272 000	620 000	850	1 300	52416	54416	54416 U	170	83	125	175	73.5	77.7	83.5	27	22	30.5	125	125	2	1	12.6	12.8	16
	85	180	128	138	150	2.1	1.1	310 000	755 000	800	1 200	52417 X	54417 X	54417 XU	179.5	88	130	185	78.5	83.5	89.5	29	23	40.5	140	130	2	1	15.4	15.8	19.5
70	85	125	55	59.2	67	1	1	96 000	264 000	1 500	2 200	52217	54217	54217 U	125	88	105	130	33.5	35.6	39.5	12	11	49.5	100	105	1	1	2.26	2.45	3.02
	85	150	87	95.2	105	1.5	1	207 000	490 000	1 100	1 600	52317	54317	54317 U	150	88	115	155	53	57.1	62	19	17.5	39	112	115	1.5	1	6.38	6.8	10.5
	90	190	135	143.4	157	2.1	1.1	330 000	825 000	750	1 100	52418 X	54418 X	54418 XU	189.5	93	140	195	82.5	86.7	93.5	30	25.5	34.5	140	140	2	1	17.5	18.1	22.5
75	90	135	62	69	76	1.1	1	114 000	310 000	1 400	2 000	52218	54218	54218 U	135	93	110	140	38	41.5	45	14	13.5	42	100	110	1	1	3.09	3.42	4.39
	90	155	88	97.2	106	1.5	1	214 000	525 000	1 100	1 600	52318	54318	54318 U	155	93	120	160	53.5	58.1	62.5	19	18	36.5	112	120	1.5	1	6.79	7.33	9.29
80	100	210	150	160	176	3	1.1	370 000	985 000	670	1 000	52420 X	54420 X	54420 XU	209.5	103	155	220	91.5	96.5	104.5	33	27	43.5	160	155	2.5	1	26.8	27.2	33.4
	100	150	67	72.8	81	1.1	1	135 000	375 000	1 300	1 900	52220	54220	54220 U	150	103	125	155	41	43.9	48	15	14	49	112	125	1	1	4.08	4.54	5.64
90	100	170	97	105.4	115	1.5	1	239 000	595 000	950	1 500	52320	54320	54320 U	170	103	135	175	59	63.2	68	21	18	42	125	135	1.5	1	8.82	9.47	11.6
	110	230	166	—	—	3	1.1	415 000	1 150 000	600	900	52422 X	—	—	229	113	—	—	101.5	—	—	37	—	—	159	2.5	1	35.6	—	—	
95	110	160	67	71.4	81	1.1	1	136 000	395 000	1 200	1 800	52222	54222	54222 U	160	113	135	165	41	43.2	48	15	14	62	125	135	1	1	4.39	4.83	5.94
	110	190	110	118.4	128	2	1	282 000	755 000	850	1 300	52322 X	54322 X	54322 XU	189.5	113	150	195	67	71.2	76	24	20.5	47	140	150	2	1	12.7	13.5	16.6
	120	250	177	—	—	4	1.5	515 000	1 540 000	560	850	52424 X	—	—	249	123	—	—	108.5	—	—	40	—	—	174	3	1.5	47.6	—	—	
100	120	170	68	71.6	82	1.1	1.1	141 000	430 000	1 200	1 800	52224	54224	54224 U	170	123	145	175	41.5	43.3	48.5	15	15	58.5	125	145	1	1	4.92	5.4	6.68
	120	210	123	131.2	143	2.1	1.1	330 000	930 000	750	1 100	52324 X	54324 X	54324 XU	209.5	123	165	220	75	79.1	85	27	22	58	160	165	2	1	17.6	16.4	22.9
	130	270	192	—	—	4	1.5	525 000	1 590 000	530	800	52426 X	—	—	269	134	—	—	117	—	—	42	—	—	188	3	1.5	57.8	—	—	
110	130	190	80	85.8	96	1.5	1.1	183 000	550 000	1 000	1 500	52226 X	54226 X	54226 XU	189.5	133	160	195	49	51.9	57	18	17	63	140	160	1.5	1	7.43	8.24	10.2
	130	225	130	—	—	2.1	1.1	350 000	1 030 000	710	1 100	52326 X	—	—	224	134	—	—	80	—	—	30	—	—	169	2	1	21.5	—	—	
	140	280	196	—	—	4	1.5	550 000	1 750 000	500	750	52428 X	—	—	279	144	—	—	120	—	—	44	—	—	198	3	1.5	62.4	—	—	
120	140	200	81	86.2	99	1.5	1.1	186 000	575 000	1 000	1 500	52228 X	54228 X	54228 XU	199.5	143	170	210	49.5	52.1	58.5	18	17	83.5	160	170	1.5	1	8.01	8.87	11.2
	140	240	140	—	—	2.1	1.1	370 000	1 130 000	670	1 000	52328 X	—	—	239	144	—	—	85.5	—	—	31	—	—	181	2	1	24.8	—	—	
	150	300	209	—	—	4	2	620 000	2 010 000	480	710	52430 X	—	—	299	153	—	—	127.5	—	—	46	—	—	212	3	2	77.8	—	—	
130	150	215	89	95.6	109	1.5	1.1	238 000	735 000	900	1 300	52230 X	54230 X	54230 XU	214.5	153	180	225	54.5	57.8	64.5	20	20.5	74.5	160	180	1.5	1	10.4	11.5	15
	150	250	140	—	—	2.1	1.1	380 000	1 200 000	630	950	52330 X	—	—	249	154	—	—	85.5	—	—	31	—	—	191	2	1	30.3	—	—	
	160	320	226	—	—	5	2	650 000	2 210 000	430	630	52432 X	—	—	319	164	—	—	138	—	—	50	—	—	226	4	2	93.6	—	—	

Note ⁽¹⁾ The outside diameter d_3 of central washers for bearing designations with an X is smaller than the outside diameter D of the housing washers.

DOUBLE-DIRECTION THRUST BALL BEARINGS

Bore Diameter 135 – 190 mm

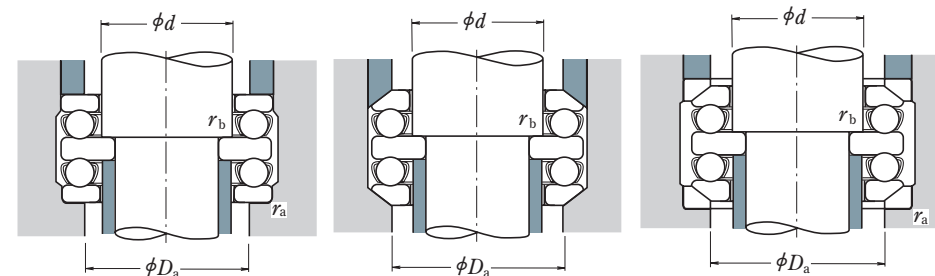
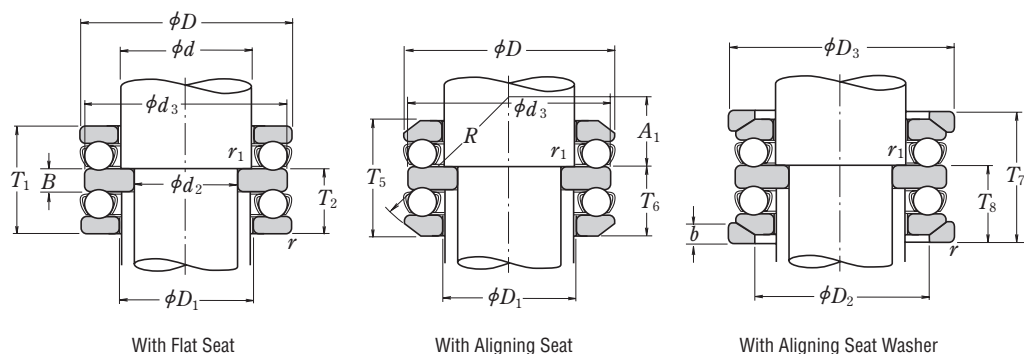

Bore Diameter (mm)	Boundary Dimensions (mm)							Basic Load Ratings (N)		Limiting Speeds (min ⁻¹)		Bearing Designations ⁽¹⁾		With Aligning Seat Washer	Dimensions (mm)										Abutment and Fillet Dimensions (mm)			Mass (kg) approx.				
	d ₂	d	D	T ₁	T ₅	T ₇	r _{min.}	r _{1 min.}	C _a	C _{0a}	Grease	Oil	With Flat Seat		With Aligning Seat	d ₃	D ₁	D ₂	D ₃	T ₂	T ₆	T ₈	B	b	A ₁	R	D _{a max.}	r _{a max.}	r _{b max.}	With Flat Seat	With Aligning Seat	With Aligning Seat Washer
135	170	340	236	—	—	5	2.1	715 000	2 480 000	400	600	52434 X	—	—	339	174	—	—	143	—	—	50	—	—	—	—	240	4	2	110	—	—
140	160	225	90	97.4	110	1.5	1.1	249 000	805 000	850	1 300	52232 X	54232 X	54232 XU	224.5	163	190	235	55	58.7	65	20	21	70	160	190	1.5	1	11.2	12.7	16.5	
	160	270	153	—	—	3	1.1	475 000	1 570 000	600	900	52332 X	—	—	269	164	—	—	93	—	—	33	—	—	—	205	2.5	1	35.1	—	—	
	180	360	245	—	—	5	3	750 000	2 730 000	380	560	52436 X	—	—	359	184	—	—	148.5	—	—	52	—	—	—	254	4	2.5	126	—	—	
150	170	240	97	104.4	117	1.5	1.1	280 000	915 000	800	1 200	52234 X	54234 X	54234 XU	239.5	173	200	250	59	62.7	69	21	21.5	87	180	200	1.5	1	13.6	15.2	19.8	
	170	280	153	—	—	3	1.1	465 000	1 570 000	560	850	52334 X	—	—	279	174	—	—	93	—	—	33	—	—	—	215	2.5	1	40.8	—	—	
	180	250	98	102.4	118	1.5	2	284 000	955 000	800	1 200	52236 X	54236 X	54236 XU	249	183	210	260	59.5	61.7	69.5	21	21.5	108.5	200	210	1.5	2	14.8	16.1	20.6	
	180	300	165	—	—	3	2	480 000	1 680 000	530	800	52336 X	—	—	299	184	—	—	101	—	—	37	—	—	—	229	2.5	2.5	46.3	—	—	
160	190	270	109	116.4	131	2	2	320 000	1 110 000	710	1 100	52238 X	54238 X	54238 XU	269	194	230	280	66.5	70.2	77.5	24	23	93.5	200	230	2	2	22.1	22.2	29.8	
	190	320	183	—	—	4	2	550 000	1 960 000	480	710	52338 X	—	—	319	195	—	—	111.5	—	—	40	—	—	—	244	3	2	113	—	—	
170	200	280	109	115.6	133	2	2	315 000	1 110 000	710	1 000	52240 X	54240 X	54240 XU	279	204	240	290	66.5	69.8	78.5	24	23	120.5	225	240	2	2	23.1	23.2	30.6	
	200	340	192	—	—	4	2	600 000	2 220 000	450	670	52340 X	—	—	339	205	—	—	117	—	—	42	—	—	—	258	3	2	78.4	—	—	
190	220	300	110	115.2	134	2	2	325 000	1 210 000	670	1 000	52244 X	54244 X	54244 XU	299	224	260	310	67	69.6	79	24	25	114	225	260	2	2	25.2	27.8	34.1	

Note ⁽¹⁾ The outside diameter d_3 of central washers for bearing designations with an X is smaller than the outside diameter D of the housing washers.

9. THRUST CYLINDRICAL ROLLER BEARINGS

INTRODUCTION C 314

BEARING TABLES

THRUST CYLINDRICAL ROLLER BEARINGS

Bore Diameter 35mm – 320mm C 316



THRUST CYLINDRICAL ROLLER BEARINGS**DESIGN, TYPES, AND FEATURES****THRUST CYLINDRICAL ROLLER BEARINGS**

These are thrust bearings containing cylindrical rollers. They can sustain only axial loads but are suitable for heavy loads and feature high axial rigidity.

Machined brass cages are used with this bearing type.

TOLERANCES AND RUNNING ACCURACY**THRUST CYLINDRICAL ROLLER BEARINGS**

..... According to Table 7.6 (Pages A140 to A142)

RECOMMENDED FITS

THRUST CYLINDRICAL ROLLER BEARINGS..... Table 8.4 (Pages A164)
Table 8.6 (Pages A165)

MINIMUM AXIAL LOAD

Be sure to apply some axial load to thrust bearings to prevent slippage between the rolling elements and raceways. For more details, please contact NSK.

THRUST CYLINDRICAL ROLLER BEARINGS

Bore Diameter 35 – 130 mm

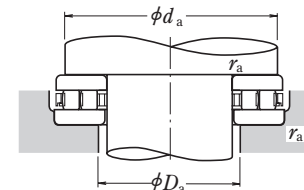
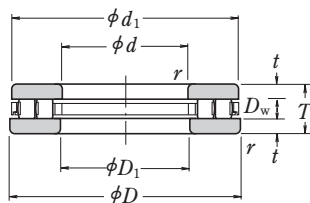

Boundary Dimensions (mm)				Basic Load Ratings (N)		Limiting Speeds (min ⁻¹)		Bearing Designation	Dimensions (mm)				Abutment and Fillet Dimensions (mm)			Mass (kg) approx.
d	D	T	r min.	Ca	C0a	Grease	Oil		d1	D1	Dw	t	da min.	Da max.	ra max.	
35	80	32	1.1	95 500	247 000	1 000	3 000	35 TMP 14	80	37	12	10	71	46	1	0.97
40	78	22	1	63 000	194 000	1 200	3 600	40 TMP 93	78	42	8	7	71	48	1	0.525
45	65	14	0.6	33 000	100 000	1 700	5 000	45 TMP 11	65	47	6	4	60	49	0.6	0.144
	85	24	1	71 000	233 000	1 100	3 400	45 TMP 93	85	47	8	8	78	53	1	0.665
50	110	27	1.1	139 000	470 000	900	2 800	50 TMP 74	109	52	11	8	100	61	1	1.52
	95	27	1.1	113 000	350 000	1 000	3 000	50 TMP 93	93	52	11	8	89	57	1	0.94
55	105	30	1.1	134 000	450 000	900	2 600	55 TMP 93	105	55.2	11	9.5	98	63	1	1.28
60	95	26	1	99 000	325 000	1 000	3 000	60 TMP 12	95	62	10	8	88	67	1	0.735
	110	30	1.1	139 000	480 000	850	2 600	60 TMP 93	110	62	11	9.5	103	68	1	1.36
65	100	27	1	110 000	325 000	950	2 800	65 TMP 12	100	67	12.5	7.25	93	71	1	0.805
	115	30	1.1	145 000	515 000	850	2 600	65 TMP 93	115	65.2	11	9.5	108	73	1	1.44
70	150	36	2	259 000	935 000	670	2 000	70 TMP 74	149	72	15	10.5	137	84	2	3.8
	125	34	1.1	191 000	635 000	750	2 200	70 TMP 93	125	72	14	10	117	78	1	1.95
75	100	19	1	63 500	221 000	1 100	3 400	75 TMP 11	100	77	8	5.5	96	79	1	0.41
	135	36	1.5	209 000	735 000	710	2 200	75 TMP 93	135	77	14	11	125	84	1.5	2.42
80	115	28	1	120 000	420 000	900	2 600	80 TMP 12	115	82	11	8.5	109	86	1	1.02
	140	36	1.5	208 000	740 000	710	2 000	80 TMP 93	138	82	14	11	130	91	1.5	2.54
85	110	19	1	75 000	298 000	1 100	3 200	85 TMP 11	110	87	7.5	5.75	105	89	1	0.46
	125	31	1	151 000	485 000	800	2 400	85 TMP 12	125	88	14	8.5	118	92	1	1.36
	150	39	1.5	257 000	995 000	630	1 900	85 TMP 93	148	87	14	12.5	140	95	1.5	3.2
90	120	22	1	96 000	370 000	950	3 000	90 TMP 11	119	91.5	9	6.5	114	95	1	0.725
	155	39	1.5	250 000	885 000	630	1 900	90 TMP 93	155	90.2	16	11.5	144	101	1.5	3.3
100	170	42	1.5	292 000	1 110 000	560	1 700	100 TMP 93	170	103	16	13	159	110	1.5	4.25
110	160	38	1.1	228 000	855 000	630	1 900	110 TMP 12	160	113	15	11.5	150	119	1	2.66
	190	48	2	390 000	1 490 000	500	1 500	110 TMP 93	190	113	19	14.5	179	120	2	6.15
120	170	39	1.1	233 000	895 000	600	1 800	120 TMP 12	170	123	15	12	160	129	1	2.93
	210	54	2.1	505 000	1 930 000	450	1 400	120 TMP 93	210	123	22	16	199	129	2	8.55
130	190	45	1.5	300 000	1 090 000	530	1 600	130 TMP 12	187	133	19	13	177	142	1.5	4.5
	225	58	2.1	585 000	2 370 000	430	1 300	130 TMP 93	225	133	22	18	214	140	2	10.4
	270	85	4	895 000	3 300 000	320	950	130 TMP 94	270	133	32	26.5	254	150	3	26.2

Remark For cylindrical roller thrust bearings not listed above, please contact NSK.

THRUST CYLINDRICAL ROLLER BEARINGS

Bore Diameter 140 – 320 mm

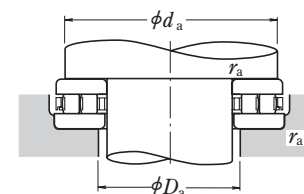
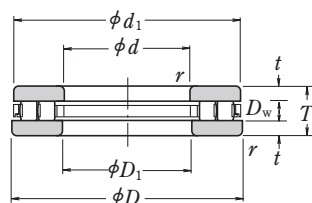

<i>d</i>	Boundary Dimensions (mm)			Basic Load Ratings (N)		Limiting Speeds (min ⁻¹)		Bearing Designation	Dimensions (mm)				Abutment and Fillet Dimensions (mm)			Mass (kg) approx.
	<i>D</i>	<i>T</i>	<i>r</i> _{min.}	<i>C</i> _a	<i>C</i> _{0a}	Grease	Oil		<i>d</i> ₁	<i>D</i> ₁	<i>D</i> _w	<i>t</i>	<i>d</i> _a _{min.}	<i>D</i> _a _{max.}	<i>r</i> _a _{max.}	
140	200	46	2	285 000	1 120 000	500	1 500	140 TMP 12 140 TMP 93 140 TMP 94	197	143	17	14.5	188	153	2	4.85
	240	60	2.1	610 000	2 360 000	400	1 200		240	143	25	17.5	226	154	2	12.2
	280	85	4	990 000	3 800 000	300	900		280	143	32	26.5	262	158	3	27.5
150	215	50	2	375 000	1 500 000	480	1 400	150 TMP 12 150 TMP 93	215	153	19	15.5	202	163	2	6.15
	250	60	2.1	635 000	2 510 000	400	1 200		250	153	25	17.5	236	165	2	12.8
160	200	31	1	173 000	815 000	630	1 900	160 TMP 11 160 TMP 93	200	162	11	10	191	168	1	2.21
	270	67	3	745 000	3 150 000	360	1 100		265	164	25	21	255	173	2.5	16.9
170	240	55	1.5	485 000	1 960 000	430	1 300	170 TMP 12 170 TMP 93	237	173	22	16.5	227	182	1.5	8.2
	280	67	3	800 000	3 500 000	340	1 000		280	173	25	21	265	183	2.5	17.7
180	300	73	3	1 000 000	4 000 000	320	950	180 TMP 93 180 TMP 94	300	185	32	20.5	284	194	2.5	22.5
	360	109	5	1 640 000	6 200 000	240	710		354	189	45	32	335	205	4	58.2
190	270	62	3	705 000	2 630 000	360	1 100	190 TMP 12 190 TMP 93	266	195	30	16	255	200	2.5	11.8
	320	78	4	1 080 000	4 500 000	300	900		320	195	32	23	303	205	3	27.6
200	250	37	1.1	365 000	1 690 000	500	1 500	200 TMP 11 200 TMP 93	247	203	17	10	242	207	1	4.1
	340	85	4	1 180 000	5 150 000	280	800		340	205	32	26.5	322	218	3	34.5
220	270	37	1.1	385 000	1 860 000	480	1 500	220 TMP 11 220 TMP 12	267	223	17	10	262	227	1	4.5
	300	63	2	770 000	3 100 000	340	1 000		297	224	30	16.5	287	232	2	13.5
240	300	45	1.5	435 000	2 160 000	400	1 200	240 TMP 11 240 TMP 12	297	243	18	13.5	288	251	1.5	7.2
	340	78	2.1	965 000	4 100 000	280	850		335	244	32	23	322	258	2	23.3
260	320	45	1.5	460 000	2 350 000	400	1 200	260 TMP 11 260 TMP 12	317	263	18	13.5	308	272	1.5	7.75
	360	79	2.1	995 000	4 350 000	280	850		355	264	32	23.5	342	276	2	25.2
280	350	53	1.5	545 000	2 800 000	340	1 000	280 TMP 11 280 TMP 12	347	283	20	16.5	335	294	1.5	11.6
	380	80	2.1	1 050 000	4 750 000	260	800		375	284	32	24	362	296	2	27.2
300	380	62	2	795 000	4 000 000	300	900	300 TMP 11 300 TMP 12	376	304	25	18.5	365	315	2	16.7
	420	95	3	1 390 000	6 250 000	220	670		415	304	38	28.5	398	322	2.5	42
320	400	63	2	820 000	4 250 000	300	900	320 TMP 11 320 TMP 12	396	324	25	19	385	335	2	18
	440	95	3	1 420 000	6 550 000	220	670		435	325	38	28.5	418	340	2.5	44.5

Remark For cylindrical roller thrust bearings not listed above, please contact NSK.

10. THRUST TAPERED ROLLER BEARINGS

INTRODUCTION C 322

BEARING TABLES

THRUST TAPERED ROLLER BEARINGS

Bore Diameter 101.600mm – 600mm C 324



DESIGN, TYPES, AND FEATURES

THRUST TAPERED ROLLER BEARINGS

These thrust bearings containing tapered rollers come in two types. TT bearings, which have a rib on the housing washer, can accurately guide the shaft in the radial direction, while TTF bearings, which have no rib on the housing washer, can tolerate some eccentricity during operation.



Fig. 1 TT and TTF Base Structure

TOLERANCES AND RUNNING ACCURACY

THRUST TAPERED ROLLER BEARINGS Table 7.7 (Page A144)

RECOMMENDED FITS

THRUST TAPERED ROLLER BEARINGS Table 8.4 (Page A164)
 Table 8.6 (Page A165)

For Inch Series tapered roller thrust bearings, please contact NSK.

MINIMUM AXIAL LOAD

Be sure to apply some axial load to thrust bearings to prevent slippage between the rolling elements and raceways. For more details, please contact NSK.

USAGE EXAMPLE

A typical structure of a heavy-duty Extruder is shown in Figure 2.

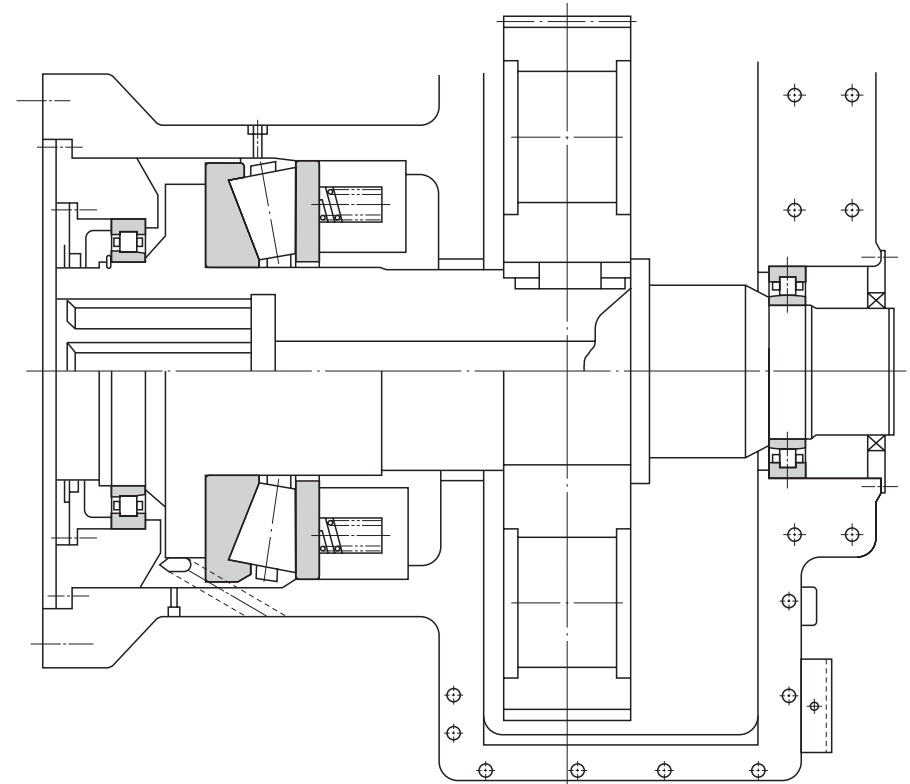
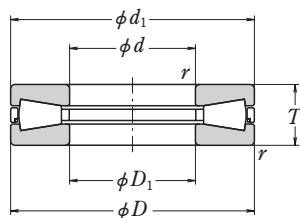

Fig. 2 Thrust Tapered Roller Bearings in a Heavy-Duty Extruder

THRUST TAPERED ROLLER BEARINGS

TT, TTF Types

Bore Diameter 101.600 – 168.275 mm



TT

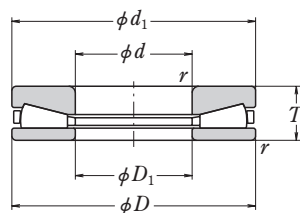

TTF

d	Boundary Dimensions (mm/inch)			Basic Load Ratings (kN)		Bearing Designation	Dimensions (mm)		Corner Radius of Shaft or Housing r _a max.	Mass (kg) approx.
	D	T	r min.	C _a	C _{0a}		D ₁	d ₁		
101.600 4.000	215.900 8.5000	46.038 1.8125	3.3	710	2 900	*101TT2151	103.200	214.300	3.3	8.9
111.760 4.4000	223.520 8.8000	55.880 2.2000	3.3	790	2 920	*111TT2251	113.300	221.900	3.3	11.2
114.300 4.5000	250.825 9.8750	53.975 2.1250	4.0	970	4 100	*114TT2551	114.500	250.825	4.0	14.4
127.000 5.0000	266.700 10.5000	58.738 2.3125	4.8	1 040	4 350	*127TT2551	128.600	265.100	4.8	17.3
	266.700 10.5000	58.738 2.3125	4.8	1 030	4 500	*127TTF2651	128.600	265.100	4.8	17.3
128.575 5.0620	265.100 10.4370	63.500 2.5000	6.4	1 040	4 350	*128TT2651	128.900	265.100	6.4	18.2
130	250	70	2.1	1 100	4 100	130TTF2501	130.3	250	2	17
135	245	65	2.1	855	3 100	135TT2401	135.3	245	2	14.5
150	300	90	5	1 470	6 300	150TTF3001	152	306	4	34.2
152.400 6.0000	317.500 12.5000	69.850 2.7500	6.4	1 470	6 300	*152TTF3151	152.700	315.900	6.4	28.9
	317.500 12.5000	69.850 2.7500	6.4	1 550	6 700	*152TT3152	152.400	317.500	6.4	28.9
165.100 6.5000	311.150 12.2500	88.900 3.5000	6.4	1 560	5 250	*165TT3151	165.400	311.150	6.4	33
168.275 6.6250	304.800 12.0000	69.850 2.7500	6.4	1 230	5 000	*168TTF3051	169.000	302.500	6.4	24.1

Note * Bearings marked with * are Inch Series bearings.

THRUST TAPERED ROLLER BEARINGS

TT, TTF Types

Bore Diameter 170 – 241.300 mm

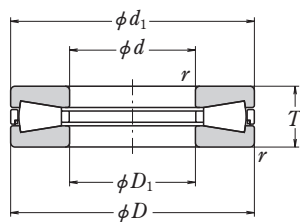

TT

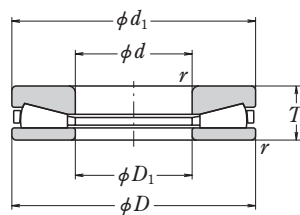

TTF

<i>d</i>	Boundary Dimensions (mm/inch)			Basic Load Ratings (kN)		Bearing Designation	Dimensions (mm)		Corner Radius of Shaft or Housing <i>r</i> _a max.	Mass (kg) approx.
	<i>D</i>	<i>T</i>	<i>r</i> min.	<i>C</i> _a	<i>C</i> _{0a}		<i>D</i> ₁	<i>d</i> ₁		
170	320	100	5	1 650	5 550	170TT3201	170.5	320	4	39.3
174.625 6.8750	358.775 14.1250	82.550 3.2500	6.4	1 740	7 400	*174TT3551	174.625	358.775	6.4	43.3
	358.775 14.1250	82.550 3.2500	6.4	1 740	7 400	*174TTF3551	174.625	358.775	6.4	43.3
177.800 7.0000	368.300 14.5000	82.550 3.2500	8.0	1 900	8 250	*177TT3651	180.400	365.800	8.0	45.9
203.200 8.0000	419.100 16.5000	92.075 3.6250	9.7	2 530	11 300	*203TT4151	205.600	416.700	9.7	66.1
	419.100 16.5000	92.075 3.6250	9.7	2 530	11 300	*203TTF4153A	203.200	419.100	9.7	66.1
	419.100 16.5000	120.650 4.7500	9.7	2 530	11 300	*203TT4152	205.600	416.700	9.7	86.6
	419.100 16.5000	120.650 4.7500	9.7	2 530	11 300	*203TTF4152	205.600	416.700	9.7	86.6
206.375 8.1250	419.100 16.5000	120.370 4.7390	C10	2 590	11 700	*206TT4151	206.375	419.100	6	85.5
228.600 9.0000	482.600 19.0000	104.775 4.1250	11.2	3 350	16 400	*228TT4851	228.900	482.600	11.2	101
	482.600 19.0000	104.775 4.1250	11.2	3 350	16 400	*228TTF4851	230.600	480.600	11.2	101
234.950 9.2500	546.100 21.5000	127.000 5.0000	15.9	4 600	21 400	*234TT5451	237.000	544.000	15.9	165
241	404	110	4	2 200	8 650	241TTF4002	241	404	3	61.8
241.300 9.5000	496.888 19.5625	129.000 5.0787	C8	3 450	16 700	*241TT4952	241.300	496.888	5	130

Note * Bearings marked with * are Inch Series bearings.

THRUST TAPERED ROLLER BEARINGS

TT, TTF Types

Bore Diameter 254.000 – 600 mm

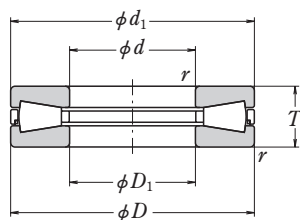

TT

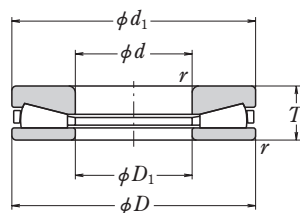

TTF

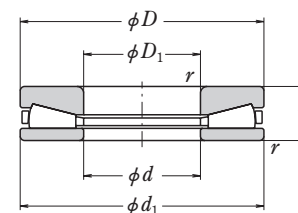

TTF-1

<i>d</i>	Boundary Dimensions (mm/inch)			Basic Load Ratings (kN)		Bearing Designation	Dimensions (mm)		Corner Radius of Shaft or Housing <i>r_a</i> max.	Mass (kg) approx.
	<i>D</i>	<i>T</i>	<i>r</i> min.	<i>C_a</i>	<i>C_{0a}</i>		<i>D₁</i>	<i>d₁</i>		
254.000 10.0000	539.750 21.2500	117.475 4.6250	11.2	3 950	18 600	*254TTF5351	254.000	539.750	11.2	142
260	360	75	2.1	1 110	4 650	260TTF3601	260.3	360	2	24.8
273.050 10.7500	552.450 21.7500	133.350 5.2500	C8	4 400	20 700	*273TT5551	273.050	552.450	5	164
279.400 11.0000	603.250 23.7500	136.525 5.3750	11.2	5 400	25 200	*279TT6051	279.700	603.250	11.2	208
330	440	85	3	1 300	6 300	330TTF4401	331	440	2.5	38.5
340	460	96	3	1 690	7 750	340TTF4603	340	460	2.5	49.2
350	460	85	2	1 370	6 600	350TTF4602A⁽¹⁾	351	450	2	40.4
360	470	85	4	1 440	6 950	360TTF4701	360.4	470	3	41.4
	600	120	4	3 700	20 100	360TTF6201	366	620	3	148
380	550	110	4	2 760	12 100	380TTF5501	381	550	3	92.9
406.400 16.0000	711.200 28.0000	146.050 5.7500	9.7	5 900	28 600	*406TT7151	406.800	711.200	9.7	266
	838.200 33.0000	177.800 7.0000	12.7	8 950	46 500	*406TT8351	406.800	837.800	12.7	510
431.800 17.0000	863.600 34.0000	228.600 9.0000	10.4	15 100	69 500	*431TTF8651	435.000	862.000	10.4	683
440	600	105	4	2 720	13 900	440TTF6001	440	600	3	93.3
450	570	100	3	2 170	10 500	450TTF5701	455	569	2.5	65.4
460	580	90	3	1 890	9 550	460TTF5801	465	579	2.5	60
500	630	82	3	2 020	11 600	500TTF6301	505	628	2.5	64.3
508	730.25	120.65	6	4 900	26 100	508TT7301	509	730.25	5	177
508.000 20.0000	990.600 39.0000	196.850 7.7500	12.7	12 000	65 000	*508TT9951	508.000	990.600	12.7	760
558	780	120	9.5	4 800	25 500	558TT7801	558	780	8	190
558.800 22.0000	1 066.800 42.0000	285.750 11.2500	10.4	21 100	94 500	*558TTF1051	561.980	1 065.219	10.4	1 260
560	670	85	3	1 950	10 700	560TTF6701	565	668	2.5	61.4
600	710	86	3	1 900	10 700	600TTF7101	604	710	2.5	66.2

Note * Bearings marked with * are Inch Series bearings.

⁽¹⁾ For this bearing, dimensional designations are defined by Figure TTF-1.

11. THRUST SPHERICAL ROLLER BEARINGS

INTRODUCTION C 332

BEARING TABLES

THRUST SPHERICAL ROLLER BEARINGS

Bore Diameter 60mm – 500mm C 334



DESIGN, TYPES, AND FEATURES

THRUST SPHERICAL ROLLER BEARINGS

These thrust bearings containing convex rollers have self-aligning capabilities and are free of any influence from mounting error or shaft deflection. E-type bearings (suffixed with E in the bearing tables) with pressed cages are available for high load applications.

Machined-brass cages are recommended for horizontal shafts or high-speed applications; please contact NSK for details.

Since there are several places where lubrication is difficult, such as the area between the roller heads and inner ring rib, the sliding surfaces between cage and guide sleeve, etc., oil lubrication should be used, even at low speeds.

Machined-brass cages are used in standard bearings of this type.

TOLERANCES AND RUNNING ACCURACY

THRUST SPHERICAL ROLLER BEARINGSTable 7.8 (Pages A145)

RECOMMENDED FITS

THRUST SPHERICAL ROLLER BEARINGSTable 8.4 (Pages A164)
 Table 8.6 (Pages A165)

DIMENSIONS RELATED TO MOUNTING

Dimensions related to mounting of thrust spherical roller bearings are listed in the bearing tables.

If the bearing load is heavy, design the shaft shoulder with ample strength to provide sufficient support for the shaft washer.

PERMISSIBLE MISALIGNMENT

The permissible misalignment of thrust spherical roller bearings varies depending on size, but it is approximately 0.018 to 0.036 radian (1° to 2°) with average loads.

MINIMUM AXIAL LOAD

Be sure to apply some axial load to thrust bearings to prevent slippage between the rolling elements and raceways. For more details, please refer to Page A198.



THRUST SPHERICAL ROLLER BEARINGS

Bore Diameter 60 – 200 mm

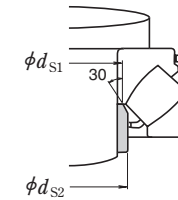
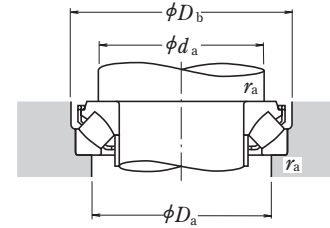
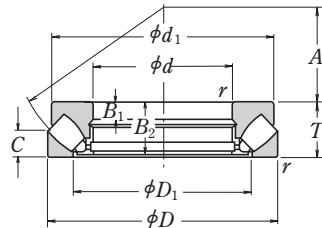
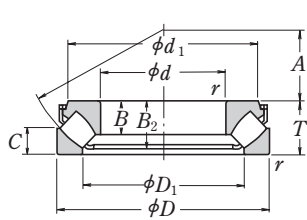

Dynamic Equivalent Load
 $P = 1.2F_r + F_a$
Static Equivalent Load
 $P_0 = 2.8F_r + F_a$
 However, $F_r/F_a \leq 0.55$ must be satisfied.

Boundary Dimensions (mm)				Basic Load Ratings (N)		Limiting Speeds (min ⁻¹) Oil	Bearing Designation	Dimensions (mm)						Spacer Sleeve Dimensions (mm)		Abutment and Fillet Dimensions (mm)				Mass (kg) approx.
d	D	T	r min.	C _a	C _{0a}			d ₁	D ₁	B, B ₁	B ₂	C	A	d _{s1} max.	d _{s2} max.	d _a ⁽¹⁾ min.	D _a max.	D _b min.	r _a max.	
60	130	42	1.5	330 000	885 000	2 600	29412 E	114.5	89	27	38	20	38	67	67	90	108	133	1.5	2.55
65	140	45	2	405 000	1 100 000	2 400	29413 E	121.5	93	29.5	40.5	22	42	72	72	100	115	143	2	3.2
70	150	48	2	450 000	1 240 000	2 400	29414 E	131.5	102	31	43	24	44	78	78	105	125	153	2	3.9
75	160	51	2	515 000	1 430 000	2 200	29415 E	138	107	33.5	46	25	47	83	83	115	132	163	2	4.65
80	170	54	2.1	575 000	1 600 000	2 000	29416 E	148	114.5	35	48.5	27	50	89	89	120	140	173	2	5.55
85	150	39	1.5	330 000	1 040 000	2 400	29317 E	134.5	112	24.5	35.5	19	50	91	91	115	135	153	1.5	2.7
	180	58	2.1	630 000	1 760 000	1 900	29417 E	156.5	124	37	51.5	28	54	95	95	130	150	183	2	6.55
90	155	39	1.5	350 000	1 080 000	2 200	29318 E	139.5	118	24.5	35	19	52	97	97	120	140	158	1.5	2.83
	190	60	2.1	695 000	1 950 000	1 800	29418 E	165.5	129.5	39	54.5	29	56	100	100	135	157	193	2	7.55
100	170	42	1.5	410 000	1 280 000	2 000	29320 E	152	128	26.2	38	20.8	58	107	107	130	150	173	1.5	3.6
	210	67	3	840 000	2 400 000	1 600	29420 E	185	144	43	59.5	33	62	111	111	150	175	214	2.5	10.3
110	190	48	2	530 000	1 710 000	1 800	29322 E	169.5	142.5	30.3	43.5	24	64	117	117	145	165	193	2	5.25
	230	73	3	1 010 000	2 930 000	1 500	29422 E	200	157	47	64.5	36	69	121	129	165	190	234	2.5	13.3
120	210	54	2.1	645 000	2 100 000	1 600	29324 E	187.5	156.5	34	48.5	27	70	130	130	160	180	214	2	7.3
	250	78	4	1 160 000	3 400 000	1 400	29424 E	215	171	50.5	69.5	38	74	132	142	180	205	254	3	16.6
130	225	58	2.1	740 000	2 450 000	1 500	29326 E	203.5	168.5	37	53.5	28	76	141	143	170	195	229	2	8.95
	270	85	4	1 330 000	3 900 000	1 200	29426 E	235	185	54	74.5	42	81	143	153	195	225	275	3	21.1
140	240	60	2.1	840 000	2 810 000	1 400	29328 E	216.5	179	38.5	54	30	82	148	154	185	205	244	2	10.4
	280	85	4	1 370 000	4 200 000	1 200	29428 E	244.5	195.5	54	74.5	42	86	153	162	205	235	285	3	22.2
150	250	60	2.1	870 000	2 900 000	1 400	29330 E	224	190	38	54.5	29	87	158	163	195	215	254	2	10.8
	300	90	4	1 580 000	4 900 000	1 100	29430 E	266	209	58	81	44	92	164	175	220	250	306	3	27.3
160	270	67	3	1 010 000	3 400 000	1 300	29332 E	243	203	42	60	33	92	169	176	210	235	275	2.5	14.3
	320	95	5	1 740 000	5 400 000	1 100	29432 E	278	224.5	60.5	84.5	46	99	175	189	230	265	326	4	32.1
170	280	67	3	1 050 000	3 500 000	1 200	29334 E	252	214.5	42.2	60.5	32	96	178	188	220	245	285	2.5	14.8
	340	103	5	1 680 000	5 800 000	1 000	29434 E	310	243	37	99	50	104	—	—	245	285	—	4	43.5
180	300	73	3	1 230 000	4 200 000	1 100	29336 E	270	227	46	65.5	36	103	189	195	235	260	306	2.5	19
	360	109	5	1 870 000	6 500 000	900	29436 E	330	255	39	105	52	110	—	—	260	300	—	4	52
190	320	78	4	1 370 000	4 700 000	1 100	29338 E	288.5	244	49	69	38	110	200	211	250	275	326	3	23
	380	115	5	2 100 000	7 450 000	850	29438 E	345	271	41	111	55	117	—	—	275	320	—	4	60
200	280	48	2	540 000	2 310 000	1 500	29240	266	236	15	46	24	108	—	—	235	255	—	2	8.55
	340	85	4	1 570 000	5 450 000	1 000	29340 E	306.5	257	53.5	75	41	116	211	224	265	295	346	3	28.5
	400	122	5	2 290 000	8 150 000	800	29440	365	280	43	117	59	122	—	—	290	335	—	4	69

Note (1) For heavy load applications, ensure that the d_a value chosen is large enough to support the shaft washer rib.

THRUST SPHERICAL ROLLER BEARINGS

Bore Diameter 220 – 420 mm

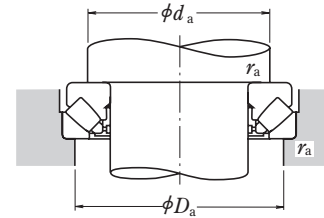
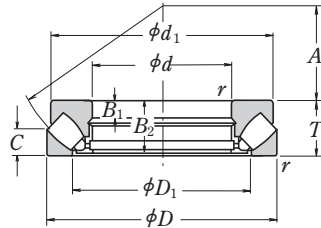

Dynamic Equivalent Load
 $P = 1.2F_r + F_a$
Static Equivalent Load
 $P_0 = 2.8F_r + F_a$
 However, $F_r/F_a \leq 0.55$ must be satisfied.

Boundary Dimensions (mm)				Basic Load Ratings (N)		Limiting Speeds (min ⁻¹) Oil	Bearing Designation	Dimensions (mm)					Abutment and Fillet Dimensions (mm)			Mass (kg) approx.	
d	D	T	r min.	C _a	C _{0a}			d ₁	D ₁	B ₁	B ₂	C	A	d _a ⁽¹⁾ min.	D _a max.		r _a max.
220	300	48	2	560 000	2 500 000	1 400	29244	285	254	15	46	24	117	260	275	2	9.2
	360	85	4	1 340 000	5 200 000	950	29344	335	280	29	81	41	125	285	315	3	33
	420	122	6	2 350 000	8 650 000	800	29444	385	308	43	117	58	132	310	355	5	74
240	340	60	2.1	800 000	3 450 000	1 200	29248	325	283	19	57	30	130	285	305	2	16.5
	380	85	4	1 360 000	5 400 000	950	29348	355	300	29	81	41	135	300	330	3	35.5
	440	122	6	2 420 000	9 100 000	750	29448	405	326	43	117	59	142	330	375	5	79
260	360	60	2.1	855 000	3 850 000	1 200	29252	345	302	19	57	30	139	305	325	2	18
	420	95	5	1 700 000	6 800 000	800	29352	390	329	32	91	45	148	330	365	4	48.5
	480	132	6	2 820 000	10 700 000	710	29452	445	357	48	127	64	154	360	405	5	105
280	380	60	2.1	885 000	4 100 000	1 100	29256	365	323	19	57	30	150	325	345	2	19
	440	95	5	1 830 000	7 650 000	800	29356	410	348	32	91	46	158	350	390	4	52.5
	520	145	6	3 400 000	13 100 000	630	29456	480	384	52	140	68	166	390	440	5	132
	520	145	6	3 950 000	14 900 000	630	29456 EM	480	380	52	140	70	166	410	445	5	134
300	420	73	3	1 160 000	5 150 000	950	29260	400	353	21	69	38	162	355	380	2.5	30
	480	109	5	2 190 000	9 100 000	710	29360	450	379	37	105	50	168	380	420	4	74
	540	145	6	3 500 000	13 700 000	630	29460	500	402	52	140	70	175	410	460	5	140
320	440	73	3	1 190 000	5 450 000	950	29264	420	372	21	69	38	172	375	400	2.5	32.5
	500	109	5	2 230 000	9 400 000	670	29364	470	399	37	105	53	180	400	440	4	77
	580	155	7.5	3 650 000	14 600 000	560	29464	555	436	55	149	75	191	435	495	6	175
340	460	73	3	1 230 000	5 750 000	900	29268	440	395	21	69	37	183	395	420	2.5	33.5
	540	122	5	2 640 000	11 200 000	630	29368	510	428	41	117	59	192	430	470	4	103
	620	170	7.5	4 400 000	17 400 000	530	29468	590	462	61	164	82	201	465	530	6	218
360	500	85	4	1 550 000	7 300 000	800	29272	480	423	25	81	44	194	420	455	3	51
	560	122	5	2 670 000	11 500 000	600	29372	525	448	41	117	59	202	450	495	4	107
	640	170	7.5	4 200 000	17 200 000	500	29472	610	480	61	164	82	210	485	550	6	228
	640	170	7.5	5 450 000	20 400 000	500	29472 EM	580	474	61	164	83	210	495	550	6	220
380	520	85	4	1 620 000	7 800 000	800	29276	496	441	27	81	42	202	440	475	3	52
	600	132	6	3 300 000	14 500 000	560	29376	568	477	44	127	63	216	480	525	5	140
	670	175	7.5	4 800 000	19 500 000	480	29476	640	504	63	168	85	230	510	575	6	254
400	540	85	4	1 640 000	8 000 000	750	29280	517	460	27	81	42	212	460	490	3	55
	620	132	6	3 250 000	14 500 000	530	29380	590	494	44	127	64	225	500	550	5	150
	710	185	7.5	5 400 000	22 100 000	450	29480	680	536	67	178	89	236	540	610	6	306
420	580	95	5	2 010 000	9 800 000	670	29284	553	489	30	91	46	225	490	525	4	72
	650	140	6	3 500 000	15 700 000	500	29384	620	520	48	135	68	235	525	575	5	170
	730	185	7.5	5 650 000	23 500 000	450	29484	700	556	67	178	89	244	560	630	6	323

Note (1) For heavy load applications, ensure that the d_a value chosen is large enough to support the shaft washer rib.

THRUST SPHERICAL ROLLER BEARINGS

Bore Diameter 440 – 500 mm

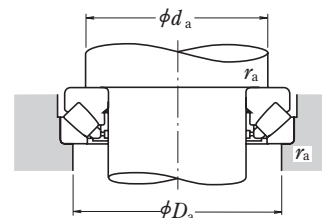
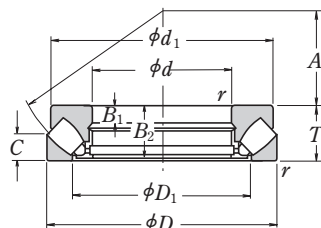

Dynamic Equivalent Load

$$P = 1.2F_r + F_a$$

Static Equivalent Load

$$P_0 = 2.8F_r + F_a$$

However, $F_r/F_a \leq 0.55$ must be satisfied.

d	Boundary Dimensions (mm)			Basic Load Ratings (N)		Limiting Speeds (min ⁻¹) Oil	Bearing Designation	Dimensions (mm)					Abutment and Fillet Dimensions (mm)			Mass (kg) approx.	
	D	T	r min.	C _a	C _{0a}			d ₁	D ₁	B ₁	B ₂	C	A	d _a ⁽¹⁾ min.	D _a max.		r _a max.
440	600	95	5	2 030 000	10 100 000	670	29288	575	508	30	91	49	235	510	545	4	77
	680	145	6	3 750 000	16 700 000	480	29388	645	548	49	140	70	245	550	600	5	190
	780	206	9.5	6 550 000	27 200 000	400	29488	745	588	74	199	100	260	595	670	8	407
	780	206	9.5	8 000 000	31 500 000	400	29488 EM	710	577	74	199	101	257	605	675	8	402
460	620	95	5	2 060 000	10 300 000	670	29292	592	530	30	91	46	245	530	570	4	80
	710	150	6	4 100 000	18 400 000	450	29392	666	567	51	144	72	257	575	630	5	210
	800	206	9.5	6 750 000	28 600 000	380	29492	765	608	74	199	100	272	615	690	8	420
480	650	103	5	2 370 000	12 100 000	600	29296	624	556	33	99	55	259	555	595	4	97
	730	150	6	4 150 000	19 000 000	450	29396	690	590	51	144	72	270	595	650	5	215
	850	224	9.5	7 200 000	31 000 000	360	29496	810	638	81	216	108	280	645	730	8	545
500	670	103	5	2 390 000	12 400 000	600	292/500	645	574	33	99	55	268	575	615	4	100
	750	150	6	4 350 000	20 400 000	450	293/500	715	611	51	144	74	280	615	670	5	220
	870	224	9.5	7 850 000	33 000 000	340	294/500	830	661	81	216	107	290	670	750	8	560

Note (1) For heavy load applications, ensure that the d_a value chosen is large enough to support the shaft washer rib.

12. NEEDLE ROLLER BEARINGS

DESIGN AND TYPES

Needle roller bearings come in various types and designs. NSK Needle Roller Bearings CAT. No. E1419 lists bearings shown in Table 1. Please refer to this catalog and contact NSK regarding bearing selection.



Table 1 Types of Needle Roller Bearings

Cage & Needle Roller Assemblies	FWJ FWF WJ		FBN, FBNP WJC FWJC	
Drawn Cup Needle Roller Bearings	FJ, FJH J, JH F, FH B, BH FJT, FJTT MFJT FJLT, FJLTT MFJLT		MFJ, MFJH MJ, MJH MF, MFH M, MH FJP JP	MFJL Y YH FIR IR
Solid Needle Roller Bearings	RNA 48 RNA 49 RNA 59 RNA 69 HJ		RLM 	RNAF RNA...TT Cone
Thrust Needle Roller Bearings Thrust Raceway Washers	FNTA NTA		FB 	FTRA TRA FTRB TRB FTRC TRC FTRD TRD FTRE TRE
Needle Rollers	A Type (Please refer to B350 page)		F Type 	P Type
	T Type 		C Type 	M Type
Cam Followers Roller Followers	FCR FCJ CR		FCRS FCJS CRS	FCRS FCJS CRS FYCR FYCJ YCR
Needle Roller Bearings for Universal Joints	ZY		NSA	
Drawn Cup Roller Clutches	RC 	FC 	RCB 	FCB

13. BALL BEARING UNITS

DESIGN AND TYPES

Ball bearing units come in various designs and types.
Please refer to the catalogs below for more detailed information:

- Ball Bearing Units CAT.No. E1154
- Steel Series Ball Bearing Units CAT.No. E1232
- Ball Bearing Units With Ductile Cast Iron Housings CAT.No. E1233
- Triple-Sealed Bearings for Ball Bearing Units CAT.No. E1234
- Stainless Series Ball Bearings Units CAT.No. E1235
- Ball Bearing Units Handbook CAT.No. E1155



14. PLUMMER BLOCKS

DESIGN, TYPES, AND FEATURES

Plummer blocks come in numerous types and sizes.

SN 5
SN 6
SN 30
SN 31
SN 2
SN 3
SN 2C
SN 3C

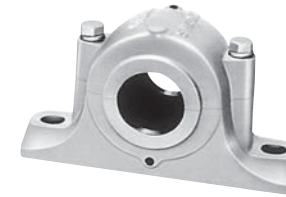

These types are the most common. Models SN30 and SN31 are for medium loads. Types SN2C and SN3C have different bore diameters on both sides.

SN 5B
SN 6B
SN 30B
SN 31B
SN 2B
SN 3B
SN 2BC
SN 3BC

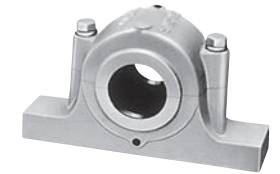

These types have the same dimensions as types SN5 and SN6. To increase the bearing box strength, no material is removed from the top or bottom of the base, so mounting holes can be drilled anywhere.

SG 5



Dustproof plummer blocks have a combination of oil seals, labyrinth seals, and oil groove seals; therefore, they are suitable for environments with dust or other foreign matter.

SD 30S
SD 31S
SD 5
SD 6
SD 2
SD 3
SD 2C
SD 3C

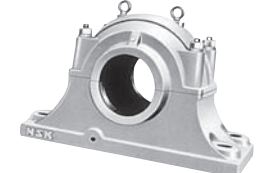

These types are large and made for heavy loads. Standard models have double seals and four mounting bolt holes. Types SD2C and SD3C feature different bore diameters on both sides.

SD31TS
SD32TS

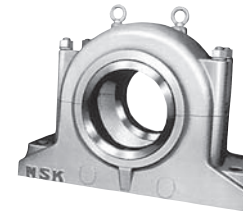

These types feature labyrinth seals, making them suitable for high-speed applications.

V · C



Single-piece plummer blocks (integrated roller bearing units) have higher rigidity and precision than split plummer blocks.



15. ACCESSORIES FOR ROLLING BEARINGS

ADAPTERS

FOR ROLLING BEARINGS Shaft Diameter 17 – 470mm..... C 348

WITHDRAWAL SLEEVES

FOR ROLLING BEARINGS Shaft Diameter 35 – 480mm..... C 356

NUTS FOR ROLLING BEARINGS..... C 362

STOPPERS FOR ROLLING BEARINGS..... C 367

LOCK-WASHERS FOR ROLLING BEARINGS..... C 368



ADAPTERS FOR ROLLING BEARINGS

Shaft Diameter 17 – 40 mm

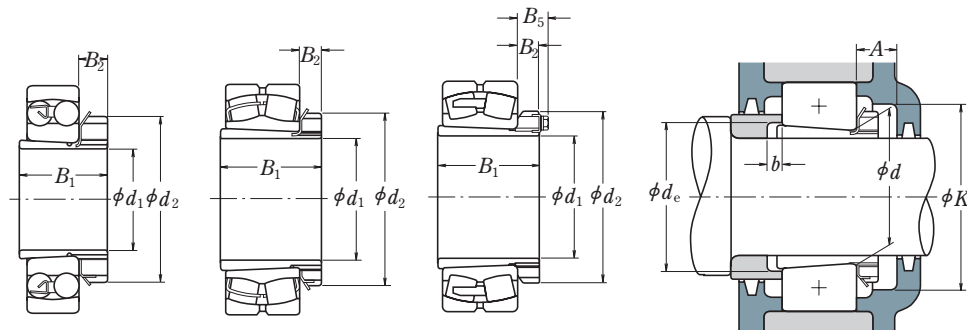

Shaft Diameter 45 – 60 mm

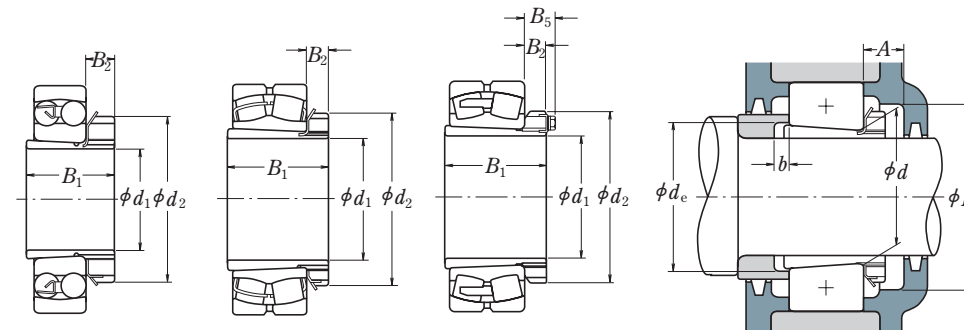

Shaft Diameter (mm) d_1	Nominal Bore Dia. (mm) d	Designation Applicable Bearings		Dimensions (mm)				Adapter Sleeve Designation	Abutment Dimensions (mm)				Mass (kg) approx.
				B_1	d_2	B_2	B_5		A min.	K min.	d_e min.	b min.	
17	20	1204K	+ H 204X	24	32	7	—	A 204X	14	39	23	5	0.045
	20	2204K	+ H 304X	28	32	7	—	A 304X	14	39	24	5	0.045
	20	1304K	+ H 304X	28	32	7	—	A 304X	14	39	24	8	0.045
	20	2304K	+ H2304X	31	32	7	—	A2304X	14	39	24	5	0.050
20	25	1205K	+ H 205X	26	38	8	—	A 205X	15	45	28	5	0.065
	25	2205K	+ H 305X	29	38	8	—	A 305X	15	45	29	5	0.075
	25	1305K	+ H 305X	29	38	8	—	A 305X	15	45	29	6	0.075
	25	21305C DKE4	+ H 305X	29	38	8	—	A 305X	15	45	29	6	0.075
	25	2305K	+ H2305X	35	38	8	—	A2305X	15	45	29	5	0.090
25	30	1206K	+ H 206X	27	45	8	—	A 206X	15	50	33	5	0.10
	30	2206K	+ H 306X	31	45	8	—	A 306X	15	50	34	5	0.11
	30	1306K	+ H 306X	31	45	8	—	A 306X	15	50	34	6	0.11
	30	21306C DKE4	+ H 306X	31	45	8	—	A 306X	15	50	34	6	0.11
	30	2306K	+ H2306X	38	45	8	—	A2306X	15	50	35	5	0.125
30	35	1207K	+ H 207X	29	52	9	—	A 207X	17	58	38	5	0.125
	35	2207K	+ H 307X	35	52	9	—	A 307X	17	58	39	5	0.145
	35	1307K	+ H 307X	35	52	9	—	A 307X	17	58	39	7	0.145
	35	21307C DKE4	+ H 307X	35	52	9	—	A 307X	17	58	39	7	0.145
	35	2307K	+ H2307X	43	52	9	—	A2307X	17	58	40	5	0.16
35	40	1208K	+ H 208X	31	58	10	—	A 208X	17	65	44	5	0.175
	40	2208K	+ H 308X	36	58	10	—	A 308X	17	65	44	5	0.19
	40	1308K	+ H 308X	36	58	10	—	A 308X	17	65	44	5	0.19
	40	21308E AKE4	+ H 308X	36	58	10	—	A 308X	17	65	44	5	0.19
	40	2308K	+ H2308X	46	58	10	—	A2308X	17	65	45	5	0.225
	40	22308E AKE4	+ H2308X	46	58	10	—	A2308X	17	65	45	5	0.225
40	45	1209K	+ H 209X	33	65	11	—	A 209X	17	72	49	5	0.225
	45	2209K	+ H 309X	39	65	11	—	A 309X	17	72	49	8	0.26
	45	1309K	+ H 309X	39	65	11	—	A 309X	17	72	49	5	0.26
	45	21309E AKE4	+ H 309X	39	65	11	—	A 309X	17	72	49	5	0.26
	45	2309K	+ H2309X	50	65	11	—	A2309X	17	72	50	5	0.30
	45	22309E AKE4	+ H2309X	50	65	11	—	A2309X	17	72	50	5	0.30

Remark Suffix X represents adapter sleeves with narrow slits for which washers with straight tabs should be used.

Shaft Diameter (mm) d_1	Nominal Bore Dia. (mm) d	Designation Applicable Bearings		Dimensions (mm)				Adapter Sleeve Designation	Abutment Dimensions (mm)				Mass (kg) approx.
				B_1	d_2	B_2	B_5		A min.	K min.	d_e min.	b min.	
45	50	1210K	+ H 210X	35	70	12	—	A 210X	19	76	53	5	0.275
	50	2210K	+ H 310X	42	70	12	—	A 310X	19	76	54	10	0.30
	50	1310K	+ H 310X	42	70	12	—	A 310X	19	76	54	5	0.30
	50	21310E AKE4	+ H 310X	42	70	12	—	A 310X	19	76	54	5	0.30
	50	2310K	+ H2310X	55	70	12	—	A2310X	19	76	56	5	0.35
	50	22310E AKE4	+ H2310X	55	70	12	—	A2310X	19	76	56	5	0.35
50	55	1211K	+ H 211X	37	75	12	—	A 211X	19	85	60	6	0.305
	55	2211K	+ H 311X	45	75	12	—	A 311X	19	85	60	11	0.35
	55	22211E AKE4	+ H 311X	45	75	12	—	A 311X	19	85	60	11	0.35
	55	1311K	+ H 311X	45	75	12	—	A 311X	19	85	60	6	0.35
	55	21311E AKE4	+ H 311X	45	75	12	—	A 311X	19	85	60	6	0.35
	55	2311K	+ H2311X	59	75	12	—	A2311X	19	85	61	6	0.40
	55	22311E AKE4	+ H2311X	59	75	12	—	A2311X	19	85	61	6	0.40
55	60	1212K	+ H 212X	38	80	13	—	A 212X	20	90	64	5	0.365
	60	2212K	+ H 312X	47	80	13	—	A 312X	20	90	65	9	0.40
	60	22212E AKE4	+ H 312X	47	80	13	—	A 312X	20	90	65	9	0.40
	60	1312K	+ H 312X	47	80	13	—	A 312X	20	90	65	5	0.40
	60	21312E AKE4	+ H 312X	47	80	13	—	A 312X	20	90	65	5	0.40
	60	2312K	+ H2312X	62	80	13	—	A2312X	20	90	66	5	0.45
	60	22312E AKE4	+ H2312X	62	80	13	—	A2312X	20	90	66	5	0.45
60	65	1213K	+ H 213X	40	85	14	—	A 213X	21	96	70	5	0.40
	65	2213K	+ H 313X	50	85	14	—	A 313X	21	96	70	8	0.45
	65	22213E AKE4	+ H 313X	50	85	14	—	A 313X	21	96	70	8	0.45
	65	1313K	+ H 313X	50	85	14	—	A 313X	21	96	70	5	0.45
	65	21313E AKE4	+ H 313X	50	85	14	—	A 313X	21	96	70	5	0.45
	65	2313K	+ H2313X	65	85	14	—	A2313X	21	96	72	5	0.55
	65	22313E AKE4	+ H2313X	65	85	14	—	A2313X	21	96	72	5	0.55
	70	22214E AKE4	+ H 314X	52	92	14	—	A 314X	21	96	70	8	0.65
	70	21314E AKE4	+ H 314X	52	92	14	—	A 314X	21	96	70	5	0.65
	70	22314E AKE4	+ H2314X	68	92	14	—	A2314X	21	96	72	5	0.80

Remark Suffix X represents adapter sleeves with narrow slits for which washers with straight tabs should be used.

ADAPTERS FOR ROLLING BEARINGS

Shaft Diameter 65 – 80 mm

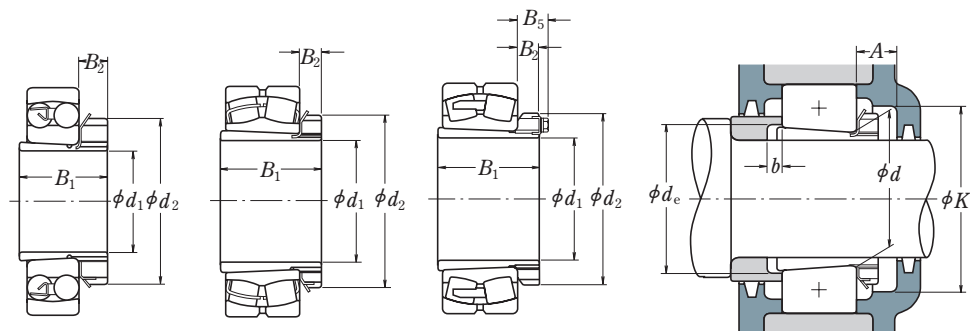

Shaft Diameter 85 – 115 mm

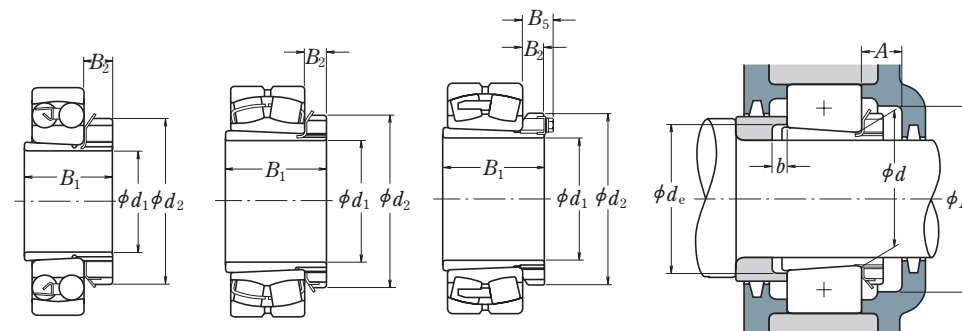

Shaft Diameter (mm) d_1	Nominal Bore Dia. (mm) d	Designation Applicable Bearings	Dimensions (mm)				Adapter Sleeve Designation	Abutment Dimensions (mm)				Mass (kg) approx.	
			B_1	d_2	B_2	B_5		A min.	K min.	d_e min.	b min.		
65	75	1215K + H 215X	43	98	15	—	A 215X	23	110	80	5	0.70	
	75	2215K + H 315X	55	98	15	—	A 315X	23	110	80	12	0.85	
	75	22215E AKE4 + H 315X	55	98	15	—	A 315X	23	110	80	12	0.85	
	75	1315K + H 315X	55	98	15	—	A 315X	23	110	80	5	0.85	
	75	21315E AKE4 + H 315X	55	98	15	—	A 315X	23	110	80	5	0.85	
	75	2315K + H2315X	73	98	15	—	A2315X	23	110	82	5	1.05	
	75	22315E AKE4 + H2315X	73	98	15	—	A2315X	23	110	82	5	1.05	
	70	80	1216K + H 216X	46	105	17	—	A 216X	25	120	85	5	0.85
		80	2216K + H 316X	59	105	17	—	A 316X	25	120	86	12	1.05
		80	22216E AKE4 + H 316X	59	105	17	—	A 316X	25	120	86	12	1.05
80		1316K + H 316X	59	105	17	—	A 316X	25	120	86	5	1.05	
80		21316E AKE4 + H 316X	59	105	17	—	A 316X	25	120	86	5	1.05	
80		2316K + H2316X	78	105	17	—	A2316X	25	120	87	5	1.3	
80		22316E AKE4 + H2316X	78	105	17	—	A2316X	25	120	87	5	1.3	
75		85	1217K + H 217X	50	110	18	—	A 217X	27	128	90	6	1.0
		85	2217K + H 317X	63	110	18	—	A 317X	27	128	91	12	1.2
		85	22217E AKE4 + H 317X	63	110	18	—	A 317X	27	128	91	12	1.2
	85	1317K + H 317X	63	110	18	—	A 317X	27	128	91	6	1.2	
	85	21317E AKE4 + H 317X	63	110	18	—	A 317X	27	128	91	6	1.2	
	85	2317K + H2317X	82	110	18	—	A2317X	27	128	94	6	1.45	
	85	22317E AKE4 + H2317X	82	110	18	—	A2317X	27	128	94	6	1.45	
	80	90	1218K + H 218X	52	120	18	—	A 218X	28	139	95	6	1.15
		90	2218K + H 318X	65	120	18	—	A 318X	28	139	96	10	1.4
		90	22218E AKE4 + H 318X	65	120	18	—	A 318X	28	139	96	10	1.4
90		1318K + H 318X	65	120	18	—	A 318X	28	139	96	6	1.4	
90		21318E AKE4 + H 318X	65	120	18	—	A 318X	28	139	96	6	1.4	
90		2318K + H2318X	86	120	18	—	A2318X	28	139	99	6	1.7	
90		23218C KE4 + H2318X	86	120	18	—	A2318X	28	139	99	6	1.7	
90		22318E AKE4 + H2318X	86	120	18	—	A2318X	28	139	99	6	1.7	

Remark Suffix X represents adapter sleeves with narrow slits for which washers with straight tabs should be used.

Shaft Diameter (mm) d_1	Nominal Bore Dia. (mm) d	Designation Applicable Bearings	Dimensions (mm)				Adapter Sleeve Designation	Abutment Dimensions (mm)				Mass (kg) approx.	
			B_1	d_2	B_2	B_5		A min.	K min.	d_e min.	b min.		
85	95	1219K + H 219X	55	125	19	—	A 219X	29	145	101	7	1.35	
	95	2219K + H 319X	68	125	19	—	A 319X	29	145	102	9	1.55	
	95	22219E AKE4 + H 319X	68	125	19	—	A 319X	29	145	102	9	1.55	
	95	1319K + H 319X	68	125	19	—	A 319X	29	145	102	7	1.55	
	95	21319C KE4 + H 319X	68	125	19	—	A 319X	29	145	102	7	1.55	
	95	2319K + H2319X	90	125	19	—	A2319X	29	145	105	7	1.9	
	95	22319E AKE4 + H2319X	90	125	19	—	A2319X	29	145	105	7	1.9	
	90	100	1220K + H 220X	58	130	20	—	A 220X	30	150	106	7	1.45
		100	2220K + H 320X	71	130	20	—	A 320X	30	150	107	8	1.7
		100	22220E AKE4 + H 320X	71	130	20	—	A 320X	30	150	107	8	1.7
100		1320K + H 320X	71	130	20	—	A 320X	30	150	107	7	1.7	
100		21320C KE4 + H 320X	71	130	20	—	A 320X	30	150	107	7	1.7	
100		2320K + H2320X	97	130	20	—	A2320X	30	150	110	7	2.15	
100		23220C KE4 + H2320X	97	130	20	—	A2320X	30	150	110	7	2.15	
100		22320E AKE4 + H2320X	97	130	20	—	A2320X	30	150	110	7	2.15	
100		110	23122C KE4 + H3122X	81	145	21	—	A3122X	32	170	117	7	2.25
		110	1222K + H 222X	63	145	21	—	A 222X	32	170	116	7	1.95
	110	2222K + H 322X	77	145	21	—	A 322X	32	170	117	6	2.3	
	110	22222E AKE4 + H 322X	77	145	21	—	A 322X	32	170	117	6	2.3	
	110	1322K + H 322X	77	145	21	—	A 322X	32	170	117	9	2.3	
	110	2322K + H2322X	105	145	21	—	A2322X	32	170	121	7	2.75	
	110	23222C KE4 + H2322X	105	145	21	—	A2322X	32	170	121	17	2.75	
	110	22322E AKE4 + H2322X	105	145	21	—	A2322X	32	170	121	7	2.75	
	110	120	23024C DKE4 + H3024	72	145	22	—	A 3024	33	180	127	7	1.95
		120	23124C KE4 + H3124	88	155	22	—	A 3124	33	180	128	7	2.65
120		22224E AKE4 + H3124	88	155	22	—	A 3124	33	180	128	11	2.65	
120		23224C KE4 + H2324	112	155	22	—	A 2324	33	180	131	17	3.2	
120		22324E AKE4 + H2324	112	155	22	—	A 2324	33	180	131	7	3.2	
115		130	23026C DKE4 + H3026	80	155	23	—	A 3026	34	190	137	8	2.85
		130	23126C KE4 + H3126	92	165	23	—	A 3126	34	190	138	8	3.65
		130	22226E AKE4 + H3126	92	165	23	—	A 3126	34	190	138	8	3.65
		130	23226C KE4 + H2326	121	165	23	—	A 2326	34	190	142	21	4.6
		130	22326C KE4 + H2326	121	165	23	—	A 2326	34	190	142	8	4.6

Remark Suffix X represents adapter sleeves with narrow slits for which washers with straight tabs should be used.

ADAPTERS FOR ROLLING BEARINGS

Shaft Diameter 125 – 170 mm

Shaft Diameter 180 – 260 mm

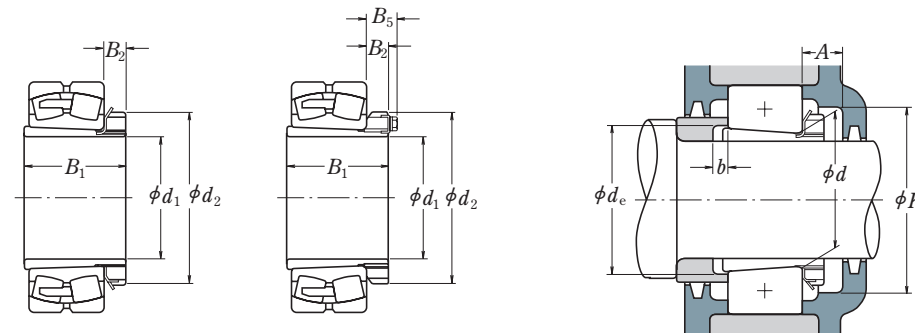
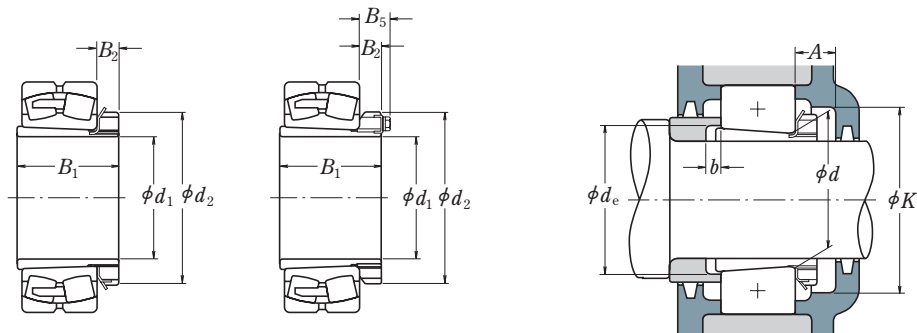

Shaft Diameter (mm) <i>d</i> ₁	Nominal Bore Dia. (mm) <i>d</i>	Designation Applicable Bearings	Dimensions (mm)				Adapter Sleeve Designation	Abutment Dimensions (mm)				Mass (kg) approx.
			<i>B</i> ₁	<i>d</i> ₂	<i>B</i> ₂	<i>B</i> ₅		<i>A</i> min.	<i>K</i> min.	<i>d</i> _e min.	<i>b</i> min.	
125	140	23028C DKE4 + H3028	82	165	24	—	A 3028	36	205	147	8	3.15
	140	23128C KE4 + H3128	97	180	24	—	A 3128	36	205	149	8	4.35
	140	22228C DKE4 + H3128	97	180	24	—	A 3128	36	205	149	8	4.35
	140	23228C KE4 + H2328	131	180	24	—	A 2328	36	205	152	22	5.55
	140	22328C KE4 + H2328	131	180	24	—	A 2328	36	205	152	8	5.55
	135	150	23030C DKE4 + H3030	87	180	26	—	A 3030	37	220	158	8
150		23130C KE4 + H3130	111	195	26	—	A 3130	37	220	160	8	5.5
150		22230C DKE4 + H3130	111	195	26	—	A 3130	37	220	160	15	5.5
150		23230C KE4 + H2330	139	195	26	—	A 2330	37	220	163	20	6.6
150		22330C AKE4 + H2330	139	195	26	—	A 2330	37	220	163	8	6.6
140		160	23932C AKE4 + H3932	78	190	28	—	A 3932	39	205	168	8
	160	23032C DKE4 + H3032	93	190	28	—	A 3032	39	230	168	8	5.2
	160	23132C KE4 + H3132	119	210	28	—	A 3132	39	230	170	8	7.65
	160	22232C DKE4 + H3132	119	210	28	—	A 3132	39	230	170	14	7.65
	160	23232C KE4 + H2332	147	210	28	—	A 2332	39	230	174	18	9.15
	160	22332C AKE4 + H2332	147	210	28	—	A 2332	39	230	174	8	9.15
150	170	23934B CAKE4 + H3934	79	200	29	—	A 3934	40	215	179	8	5.07
	170	23034C DKE4 + H3034	101	200	29	—	A 3034	40	250	179	8	6.0
	170	23134C KE4 + H3134	122	220	29	—	A 3134	40	250	180	8	8.4
	170	22234C DKE4 + H3134	122	220	29	—	A 3134	40	250	180	10	8.4
	170	23234C KE4 + H2334	154	220	29	—	A 2334	40	250	185	18	10
	170	22334C AKE4 + H2334	154	220	29	—	A 2334	40	250	185	8	10
160	180	23936C AKE4 + H3936	87	210	30	—	A 3936	41	230	189	8	5.87
	180	23036C DKE4 + H3036	109	210	30	—	A 3036	41	260	189	8	6.85
	180	23136C KE4 + H3136	131	230	30	—	A 3136	41	260	191	8	9.5
	180	22236C DKE4 + H3136	131	230	30	—	A 3136	41	260	191	18	9.5
	180	23236C KE4 + H2336	161	230	30	—	A 2336	41	260	195	22	11.5
	180	22336C AKE4 + H2336	161	230	30	—	A 2336	41	260	195	8	11.5
170	190	23938C AKE4 + H3938	89	220	31	—	A 3938	43	240	199	9	6.35
	190	23038C AKE4 + H3038	112	220	31	—	A 3038	43	270	199	9	7.45
	190	23138C KE4 + H3138	141	240	31	—	A 3138	43	270	202	9	11
	190	22238C AKE4 + H3138	141	240	31	—	A 3138	43	270	202	21	11
	190	23238C KE4 + H2338	169	240	31	—	A 2338	43	270	206	21	12.5
	190	22338C AKE4 + H2338	169	240	31	—	A 2338	43	270	206	9	12.5

Shaft Diameter (mm) <i>d</i> ₁	Nominal Bore Dia. (mm) <i>d</i>	Designation Applicable Bearings	Dimensions (mm)				Adapter Sleeve Designation	Abutment Dimensions (mm)				Mass (kg) approx.
			<i>B</i> ₁	<i>d</i> ₂	<i>B</i> ₂	<i>B</i> ₅		<i>A</i> min.	<i>K</i> min.	<i>d</i> _e min.	<i>b</i> min.	
180	200	23940C AKE4 + H3940	98	240	32	—	A 3940	46	260	210	10	8.0
	200	23040C AKE4 + H3040	120	240	32	—	A 3040	46	280	210	10	9.2
	200	23140C KE4 + H3140	150	250	32	—	A 3140	46	280	212	10	12
	200	22240C AKE4 + H3140	150	250	32	—	A 3140	46	280	212	24	12
	200	23240C KE4 + H2340	176	250	32	—	A 2340	46	280	216	20	14
	200	22340C AKE4 + H2340	176	250	32	—	A 2340	46	280	216	10	14
200	220	23944C AKE4 + H3944	96	260	30	41	A 3944	55	280	231	10	8.32
	220	23044C AKE4 + H3044	128	260	30	41	A 3044	55	320	231	12	10.5
	220	23144C KE4 + H3144	158	280	32	44	A 3144	55	320	233	10	14.5
	220	22244C AKE4 + H3144	158	280	32	44	A 3144	55	320	233	22	14.5
	220	23244C KE4 + H2344	183	280	32	44	A 2344	55	320	236	11	16.5
	220	22344C AKE4 + H2344	183	280	32	44	A 2344	55	320	236	10	16.5
220	240	23948C AKE4 + H3948	101	290	34	46	A 3948	60	300	251	11	11.2
	240	23048C AKE4 + H3048	133	290	34	46	A 3048	60	340	251	11	13
	240	23148C KE4 + H3148	169	300	34	46	A 3148	60	340	254	11	17.5
	240	22248C AKE4 + H3148	169	300	34	46	A 3148	60	340	254	19	17.5
	240	23248C AKE4 + H2348	196	300	34	46	A 2348	60	340	257	6	19.5
	240	22348C AKE4 + H2348	196	300	34	46	A 2348	60	340	257	11	19.5
240	260	23952C AKE4 + H3952	116	310	34	46	A 3952	60	330	272	11	13.4
	260	23052C AKE4 + H3052	147	310	34	46	A 3052	60	370	272	13	15.5
	260	23152C AKE4 + H3152	187	330	36	49	A 3152	60	370	276	11	22
	260	22252C AKE4 + H3152	187	330	36	49	A 3152	60	370	276	25	22
	260	23252C AKE4 + H2352	208	330	36	49	A 2352	60	370	278	2	24
	260	22352C AKE4 + H2352	208	330	36	49	A 2352	60	370	278	11	24
260	280	23956C AKE4 + H3956	121	330	38	50	A 3956	65	350	292	12	15.5
	280	23056C AKE4 + H3056	152	330	38	50	A 3056	65	390	292	12	17.5
	280	23156C AKE4 + H3156	192	350	38	51	A 3156	65	390	296	12	24.5
	280	22256C AKE4 + H3156	192	350	38	51	A 3156	65	390	296	28	24.5
	280	23256C AKE4 + H2356	221	350	38	51	A 2356	65	390	299	11	28
	280	22356C AKE4 + H2356	221	350	38	51	A 2356	65	390	299	12	28

ADAPTERS FOR ROLLING BEARINGS

Shaft Diameter 280 – 410 mm

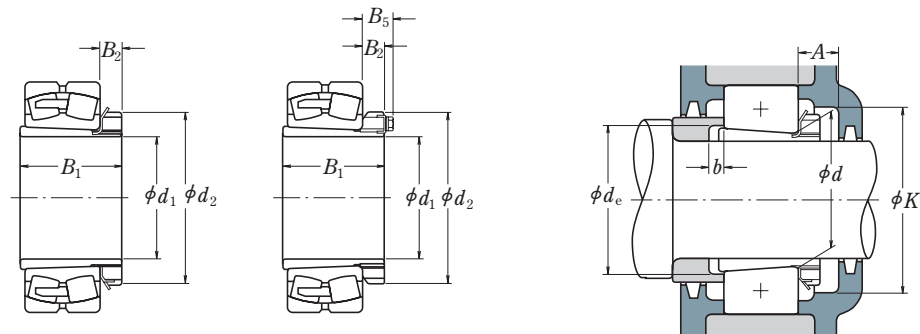

Shaft Diameter 430 – 470 mm

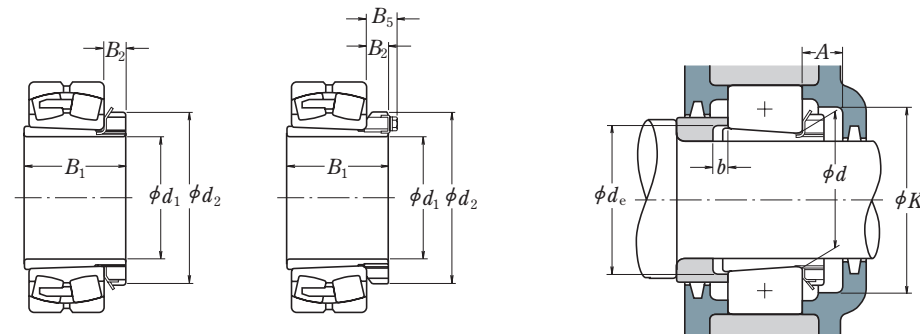

Shaft Diameter (mm) d_1	Nominal Bore Dia. (mm) d	Designation Applicable Bearings	Dimensions (mm)				Adapter Sleeve Designation	Abutment Dimensions (mm)				Mass (kg) approx.
			B_1	d_2	B_2	B_5		A min.	K min.	d_e min.	b min.	
280	300	23960CAKE4 + H3960	140	360	42	54	A3960	69	380	313	12	20.7
	300	23060CAKE4 + H3060	168	360	42	54	A3060	69	430	313	12	23
	300	23160CAKE4 + H3160	208	380	40	53	A3160	69	430	317	12	30
	300	22260CAKE4 + H3160	208	380	40	53	A3160	69	430	317	32	30
	300	23260CAKE4 + H3260	240	380	40	53	A3260	69	430	321	12	34
	300	320	23964CAKE4 + H3964	140	380	42	55	A3964	72	400	334	13
320		23064CAKE4 + H3064	171	380	42	55	A3064	72	450	334	13	24.5
320		23164CAKE4 + H3164	226	400	42	56	A3164	72	450	339	13	35
320		22264CAKE4 + H3164	226	400	42	56	A3164	72	450	339	39	35
320		23264CAKE4 + H3264	258	400	42	56	A3264	72	450	343	13	39.5
320		340	23968CAKE4 + H3968	144	400	45	58	A3968	75	430	354	14
	340	23068CAKE4 + H3068	187	400	45	58	A3068	75	490	355	14	28.5
	340	23168CAKE4 + H3168	254	440	55	72	A3168	75	490	360	14	49.5
	340	23268CAKE4 + H3268	288	440	55	72	A3268	75	490	364	14	54.5
340	360	23972CAKE4 + H3972	144	420	45	58	A3972	75	450	374	14	25.7
	360	23072CAKE4 + H3072	188	420	45	58	A3072	75	510	375	14	30.5
	360	23172CAKE4 + H3172	259	460	58	75	A3172	75	510	380	14	54
	360	23272CAKE4 + H3272	299	460	58	75	A3272	75	510	385	14	60.5
360	380	23976CAKE4 + H3976	164	450	48	62	A3976	82	480	396	15	31.9
	380	23076CAKE4 + H3076	193	450	48	62	A3076	82	540	396	15	36
	380	23176CAKE4 + H3176	264	490	60	77	A3176	82	540	401	15	61.5
	380	23276CAKE4 + H3276	310	490	60	77	A3276	82	540	405	15	69.5
380	400	23980CAKE4 + H3980	168	470	52	66	A3980	86	500	417	15	35.2
	400	23080CAKE4 + H3080	210	470	52	66	A3080	86	580	417	15	41.5
	400	23180CAKE4 + H3180	272	520	62	82	A3180	86	580	421	15	70.5
	400	23280CAKE4 + H3280	328	520	62	82	A3280	86	580	427	15	81
400	420	23984CAKE4 + H3984	168	490	52	66	A3984	86	520	437	16	36.6
	420	23084CAKE4 + H3084	212	490	52	66	A3084	86	600	437	16	43.5
	420	23184CAKE4 + H3184	304	540	70	90	A3184	86	600	443	16	84
	420	23284CAKE4 + H3284	352	540	70	90	A3284	86	600	448	16	94
410	440	23988CAKE4 + H3988	189	520	60	77	A3988	99	550	458	17	58.6
	440	23088CAKE4 + H3088	228	520	60	77	A3088	99	620	458	17	65
	440	23188CAKE4 + H3188	307	560	70	90	A3188	99	620	464	17	104
	440	23288CAKE4 + H3288	361	560	70	90	A3288	99	620	469	17	118

Shaft Diameter (mm) d_1	Nominal Bore Dia. (mm) d	Designation Applicable Bearings	Dimensions (mm)				Adapter Sleeve Designation	Abutment Dimensions (mm)				Mass (kg) approx.
			B_1	d_2	B_2	B_5		A min.	K min.	d_e min.	b min.	
430	460	23992CAKE4 + H3992	189	540	60	77	A3992	99	570	478	17	62
	460	23092CAKE4 + H3092	234	540	60	77	A3092	99	650	478	17	69.5
	460	23192CAKE4 + H3192	326	580	75	95	A3192	99	650	485	17	116
	460	23292CAKE4 + H3292	382	580	75	95	A3292	99	650	491	17	132
450	480	23996CAKE4 + H3996	200	560	60	77	A3996	99	600	499	18	67.5
	480	23096CAKE4 + H3096	237	560	60	77	A3096	99	690	499	18	73.5
	480	23196CAKE4 + H3196	335	620	75	95	A3196	99	690	505	18	133
	480	23296CAKE4 + H3296	397	620	75	95	A3296	99	690	512	18	152
470	500	239500CAKE4 + H39/500	208	580	68	85	A39/500	109	620	519	18	74.6
	500	230500CAKE4 + H30/500	247	580	68	85	A30/500	109	700	519	18	82
	500	231500CAKE4 + H31/500	356	630	80	100	A31/500	109	700	527	18	143
	500	232500CAKE4 + H32/500	428	630	80	100	A32/500	109	700	534	18	166

WITHDRAWAL SLEEVES FOR ROLLING BEARINGS

Shaft Diameter 35 – 85 mm

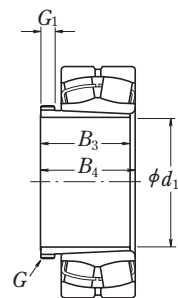

Shaft Diameter 90 – 135 mm

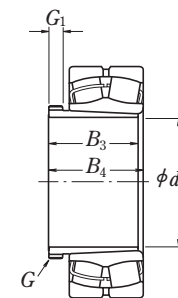

Shaft Diameter (mm) d_1	Nominal Bore Dia. (mm) d	Designation Applicable Bearings	Screw Threads G	Dimensions (mm)			Mass (kg) approx.	
				B_3	G_1	B_4		
35	40	21308EAKE4 + AH 308	M 45 × 1.5	29	6	32	0.09	
	40	22308EAKE4 + AH 2308	M 45 × 1.5	40	7	43	0.13	
	40	45	21309EAKE4 + AH 309	M 50 × 1.5	31	6	34	0.11
		45	22309EAKE4 + AH 2309	M 50 × 1.5	44	7	47	0.165
45	50	21310EAKE4 + AHX 310	M 55 × 2	35	7	38	0.16	
	50	22310EAKE4 + AHX 2310	M 55 × 2	50	9	53	0.235	
50	55	22211EAKE4 + AHX 311	M 60 × 2	37	7	40	0.19	
	55	21311EAKE4 + AHX 311	M 60 × 2	37	7	40	0.19	
	55	22311EAKE4 + AHX 2311	M 60 × 2	54	10	57	0.285	
55	60	22212EAKE4 + AHX 312	M 65 × 2	40	8	43	0.215	
	60	21312EAKE4 + AHX 312	M 65 × 2	40	8	43	0.215	
	60	22312EAKE4 + AHX 2312	M 65 × 2	58	11	61	0.34	
60	65	22213EAKE4 + AH 313	M 75 × 2	42	8	45	0.255	
	65	21313EAKE4 + AH 313	M 75 × 2	42	8	45	0.255	
	65	22313EAKE4 + AH 2313	M 75 × 2	61	12	64	0.395	
65	70	22214EAKE4 + AH 314	M 80 × 2	43	8	47	0.28	
	70	21314EAKE4 + AH 314	M 80 × 2	43	8	47	0.28	
	70	22314EAKE4 + AHX 2314	M 80 × 2	64	12	68	0.53	
70	75	22215EAKE4 + AH 315	M 85 × 2	45	8	49	0.315	
	75	21315EAKE4 + AH 315	M 85 × 2	45	8	49	0.315	
	75	22315EAKE4 + AHX 2315	M 85 × 2	68	12	72	0.605	
75	80	22216EAKE4 + AH 316	M 90 × 2	48	8	52	0.365	
	80	21316EAKE4 + AH 316	M 90 × 2	48	8	52	0.365	
	80	22316EAKE4 + AHX 2316	M 90 × 2	71	12	75	0.665	
80	85	22217EAKE4 + AHX 317	M 95 × 2	52	9	56	0.48	
	85	21317EAKE4 + AHX 317	M 95 × 2	52	9	56	0.48	
	85	22317EAKE4 + AHX 2317	M 95 × 2	74	13	78	0.745	
85	90	22218EAKE4 + AHX 318	M 100 × 2	53	9	57	0.52	
	90	21318EAKE4 + AHX 318	M 100 × 2	53	9	57	0.52	
	90	23218CKE4 + AHX 3218	M 100 × 2	63	10	67	0.58	
	90	22318EAKE4 + AHX 2318	M 100 × 2	79	14	83	0.845	

Shaft Diameter (mm) d_1	Nominal Bore Dia. (mm) d	Designation Applicable Bearings	Screw Threads G	Dimensions (mm)			Mass (kg) approx.
				B_3	G_1	B_4	
90	95	22219EAKE4 + AHX 319	M 105 × 2	57	10	61	0.595
	95	21319CKE4 + AHX 319	M 105 × 2	57	10	61	0.595
	95	22319EAKE4 + AHX 2319	M 105 × 2	85	16	89	0.89
95	100	21320CKE4 + AHX 3120	M 110 × 2	64	11	68	0.70
	100	22220EAKE4 + AHX 320	M 110 × 2	59	10	63	0.66
	100	21320CKE4 + AHX 320	M 110 × 2	59	10	63	0.66
	100	23220CKE4 + AHX 3220	M 110 × 2	73	11	77	0.77
	100	22320EAKE4 + AHX 2320	M 110 × 2	90	16	94	1.0
105	110	23122CKE4 + AHX 3122	M 120 × 2	68	11	72	0.76
	110	22222EAKE4 + AHX 3122	M 120 × 2	68	11	72	0.76
	110	24122CK30E4 + AH 24122	M 115 × 2	82	13	91	0.73
115	110	23222CKE4 + AHX 3222	M 125 × 2	82	11	86	1.04
	110	22322EAKE4 + AHX 2322	M 125 × 2	98	16	102	1.35
	120	23024CDKE4 + AHX 3024	M 130 × 2	60	13	64	0.75
125	120	24024CK30E4 + AH 24024	M 125 × 2	73	13	82	0.70
	120	23124CKE4 + AHX 3124	M 130 × 2	75	12	79	0.95
	120	22224EAKE4 + AHX 3124	M 130 × 2	75	12	79	0.95
135	120	24124CK30E4 + AH 24124	M 130 × 2	93	13	102	1.02
	120	23224CKE4 + AHX 3224	M 135 × 2	90	13	94	1.3
	120	22324EAKE4 + AHX 2324	M 135 × 2	105	17	109	1.6
135	130	23026CDKE4 + AHX 3026	M 140 × 2	67	14	71	0.95
	130	24026CK30E4 + AH 24026	M 135 × 2	83	14	93	0.89
	130	23126CKE4 + AHX 3126	M 140 × 2	78	12	82	1.08
	130	22226EAKE4 + AHX 3126	M 140 × 2	78	12	82	1.08
	130	24126CK30E4 + AH 24126	M 140 × 2	94	14	104	1.14
135	130	23226CKE4 + AHX 3226	M 145 × 2	98	15	102	1.58
	130	22326CKE4 + AHX 2326	M 145 × 2	115	19	119	1.97
	140	23028CDKE4 + AHX 3028	M 150 × 2	68	14	73	1.01
	140	24028CK30E4 + AH 24028	M 145 × 2	83	14	93	0.96
	140	23128CKE4 + AHX 3128	M 150 × 2	83	14	88	1.28
	140	22228CDKE4 + AHX 3128	M 150 × 2	83	14	88	1.28
	140	24128CK30E4 + AH 24128	M 150 × 2	99	14	109	1.3
	140	23228CKE4 + AHX 3228	M 155 × 3	104	15	109	1.84
	140	22328CKE4 + AHX 2328	M 155 × 3	125	20	130	2.33

WITHDRAWAL SLEEVES FOR ROLLING BEARINGS

Shaft Diameter 145 – 180 mm

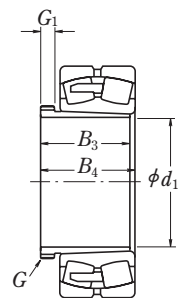

Shaft Diameter 190 – 260 mm

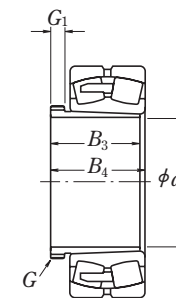

Shaft Diameter (mm) d_1	Nominal Bore Dia. (mm) d	Designation Applicable Bearings	Screw Threads G	Dimensions (mm)			Mass (kg) approx.
				B_3	G_1	B_4	
145	150	23030CDKE4 + AHX 3030	M 160 × 3	72	15	77	1.15
	150	24030CK30E4 + AH 24030	M 155 × 3	90	15	101	1.11
	150	23130CKE4 + AHX 3130	M 165 × 3	96	15	101	1.79
	150	22230CDKE4 + AHX 3130	M 165 × 3	96	15	101	1.79
	150	24130CK30E4 + AH 24130	M 160 × 3	115	15	126	1.63
	150	23230CKE4 + AHX 3230	M 165 × 3	114	17	119	2.22
	150	22330CAKE4 + AHX 2330	M 165 × 3	135	24	140	2.82
150	160	23032CDKE4 + AH 3032	M 170 × 3	77	16	82	2.05
	160	24032CK30E4 + AH 24032	M 170 × 3	95	15	106	2.28
	160	23132CKE4 + AH 3132	M 180 × 3	103	16	108	3.2
	160	22232CDKE4 + AH 3132	M 180 × 3	103	16	108	3.2
	160	24132CK30E4 + AH 24132	M 170 × 3	124	15	135	3.03
	160	23232CKE4 + AH 3232	M 180 × 3	124	20	130	4.1
	160	22332CAKE4 + AH 2332	M 180 × 3	140	24	146	4.7
160	170	23034CDKE4 + AH 3034	M 180 × 3	85	17	90	2.45
	170	24034CK30E4 + AH 24034	M 180 × 3	106	16	117	2.74
	170	23134CKE4 + AH 3134	M 190 × 3	104	16	109	3.4
	170	22234CDKE4 + AH 3134	M 190 × 3	104	16	109	3.4
	170	24134CK30E4 + AH 24134	M 180 × 3	125	16	136	3.26
	170	23234CKE4 + AH 3234	M 190 × 3	134	24	140	4.8
	170	22334CAKE4 + AH 2334	M 190 × 3	146	24	152	5.25
170	180	23036CDKE4 + AH 3036	M 190 × 3	92	17	98	2.8
	180	24036CK30E4 + AH 24036	M 190 × 3	116	16	127	3.19
	180	23136CKE4 + AH 3136	M 200 × 3	116	19	122	4.2
	180	24136CK30E4 + AH 24136	M 190 × 3	134	16	145	3.74
	180	22236CDKE4 + AH 2236	M 200 × 3	105	17	110	3.75
	180	23236CKE4 + AH 3236	M 200 × 3	140	24	146	5.3
	180	22336CAKE4 + AH 2336	M 200 × 3	154	26	160	5.85
180	190	23038CAKE4 + AH 3038	Tr 205 × 4	96	18	102	3.35
	190	24038CK30E4 + AH 24038	M 200 × 3	118	18	131	3.47
	190	23138CKE4 + AH 3138	Tr 210 × 4	125	20	131	4.9
	190	24138CK30E4 + AH 24138	M 200 × 3	146	18	159	4.38
	190	22238CAKE4 + AH 2238	Tr 210 × 4	112	18	117	4.25
	190	23238CKE4 + AH 3238	Tr 210 × 4	145	25	152	5.9
	190	22338CAKE4 + AH 2338	Tr 210 × 4	160	26	167	6.65

Shaft Diameter (mm) d_1	Nominal Bore Dia. (mm) d	Designation Applicable Bearings	Screw Threads G	Dimensions (mm)			Mass (kg) approx.
				B_3	G_1	B_4	
190	200	23040CAKE4 + AH 3040	Tr 215 × 4	102	19	108	3.8
	200	24040CK30E4 + AH 24040	Tr 210 × 4	127	18	140	3.92
	200	23140CKE4 + AH 3140	Tr 220 × 4	134	21	140	5.5
	200	24140CK30E4 + AH 24140	Tr 210 × 4	158	18	171	5.0
	200	22240CAKE4 + AH 2240	Tr 220 × 4	118	19	123	4.7
	200	23240CKE4 + AH 3240	Tr 220 × 4	153	25	160	6.7
	200	22340CAKE4 + AH 2340	Tr 220 × 4	170	30	177	7.55
200	220	23044CAKE4 + AH 3044	Tr 235 × 4	111	20	117	7.4
	220	24044CK30E4 + AH 24044	Tr 230 × 4	138	20	152	8.23
	220	23144CKE4 + AH 3144	Tr 240 × 4	145	23	151	10.5
	220	24144CK30E4 + AH 24144	Tr 230 × 4	170	20	184	10.3
	220	22244CAKE4 + AH 2244	Tr 240 × 4	130	20	136	9.1
	220	23244CKE4 + AH 3244	Tr 240 × 4	181	30	189	13.5
	220	22344CAKE4 + AH 2344	Tr 240 × 4	181	30	189	13.5
220	240	23048CAKE4 + AH 3048	Tr 260 × 4	116	21	123	8.75
	240	24048CK30E4 + AH 24048	Tr 250 × 4	138	20	153	9.0
	240	23148CKE4 + AH 3148	Tr 260 × 4	154	25	161	12
	240	24148CK30E4 + AH 24148	Tr 260 × 4	180	20	195	12.6
	240	22248CAKE4 + AH 2248	Tr 260 × 4	144	21	150	11
	240	23248CKE4 + AH 3248	Tr 260 × 4	189	30	197	15.5
	240	22348CAKE4 + AH 2348	Tr 260 × 4	189	30	197	15.5
240	260	23052CAKE4 + AH 3052	Tr 280 × 4	128	23	135	10.5
	260	24052CAK30E4 + AH 24052	Tr 270 × 4	162	22	178	11.7
	260	23152CAKE4 + AH 3152	Tr 290 × 4	172	26	179	16
	260	24152CAK30E4 + AH 24152	Tr 280 × 4	202	22	218	15.5
	260	22252CAKE4 + AH 2252	Tr 290 × 4	155	23	161	14
	260	23252CAKE4 + AH 3252	Tr 290 × 4	205	30	213	19.5
	260	22352CAKE4 + AH 2352	Tr 290 × 4	205	30	213	19.5
260	280	23056CAKE4 + AH 3056	Tr 300 × 4	131	24	139	12
	280	24056CAK30E4 + AH 24056	Tr 290 × 4	162	22	179	12.6
	280	23156CAKE4 + AH 3156	Tr 310 × 5	175	28	183	17.5
	280	24156CAK30E4 + AH 24156	Tr 300 × 4	202	22	219	16.8
	280	22256CAKE4 + AH 2256	Tr 310 × 5	155	24	163	15
	280	23256CAKE4 + AH 3256	Tr 310 × 5	212	30	220	21.5
	280	22356CAKE4 + AH 2356	Tr 310 × 5	212	30	220	21.5

WITHDRAWAL SLEEVES FOR ROLLING BEARINGS

Shaft Diameter 280 – 380 mm

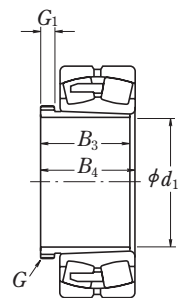

Shaft Diameter 400 – 480 mm

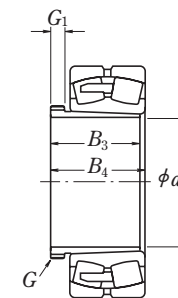

Shaft Diameter (mm) d_1	Nominal Bore Dia. (mm) d	Designation Applicable Bearings	Screw Threads G	Dimensions (mm)			Mass (kg) approx.
				B_3	G_1	B_4	
280	300	23060CAKE4 + AH 3060	Tr 320 x 5	145	26	153	14.5
	300	24060CAK30E4 + AH 24060	Tr 310 x 5	184	24	202	15.5
	300	23160CAKE4 + AH 3160	Tr 330 x 5	192	30	200	21
	300	24160CAK30E4 + AH 24160	Tr 320 x 5	224	24	242	20.3
	300	22260CAKE4 + AH 2260	Tr 330 x 5	170	26	178	18
	300	23260CAKE4 + AH 3260	Tr 330 x 5	228	34	236	20
300	320	23064CAKE4 + AH 3064	Tr 345 x 5	149	27	157	16
	320	24064CAK30E4 + AH 24064	Tr 330 x 5	184	24	202	16.4
	320	23164CAKE4 + AH 3164	Tr 350 x 5	209	31	217	24.5
	320	24164CAK30E4 + AH 24164	Tr 340 x 5	242	24	260	23.5
	320	23264CAKE4 + AH 3264	Tr 350 x 5	246	36	254	25
	320	23068CAKE4 + AH 3068	Tr 365 x 5	162	28	171	19.5
320	340	24068CAK30E4 + AH 24068	Tr 360 x 5	206	26	225	21.2
	340	23168CAKE4 + AH 3168	Tr 370 x 5	225	33	234	29
	340	24168CAK30E4 + AH 24168	Tr 360 x 5	269	26	288	28.3
	340	23268CAKE4 + AH 3268	Tr 370 x 5	264	38	273	35.5
	340	23072CAKE4 + AH 3072	Tr 385 x 5	167	30	176	21
	340	24072CAK30E4 + AH 24072	Tr 380 x 5	206	26	226	22.5
340	360	23172CAKE4 + AH 3172	Tr 400 x 5	229	35	238	33
	360	24172CAK30E4 + AH 24172	Tr 380 x 5	269	26	289	30
	360	23272CAKE4 + AH 3272	Tr 400 x 5	274	40	283	41.5
	360	23076CAKE4 + AH 3076	Tr 410 x 5	170	31	180	23.5
	360	24076CAK30E4 + AH 24076	Tr 400 x 5	208	28	228	24.1
	360	23176CAKE4 + AH 3176	Tr 420 x 5	232	36	242	35.5
360	380	24176CAK30E4 + AH 24176	Tr 400 x 5	271	28	291	32.1
	380	23276CAKE4 + AH 3276	Tr 420 x 5	284	42	294	45.5
	380	23080CAKE4 + AH 3080	Tr 430 x 5	183	33	193	27.5
	380	24080CAK30E4 + AH 24080	Tr 420 x 5	228	28	248	28
	380	23180CAKE4 + AH 3180	Tr 440 x 5	240	38	250	39.5
	380	24180CAK30E4 + AH 24180	Tr 420 x 5	278	28	298	34.8
380	400	23280CAKE4 + AH 3280	Tr 440 x 5	302	44	312	51.5

Shaft Diameter (mm) d_1	Nominal Bore Dia. (mm) d	Designation Applicable Bearings	Screw Threads G	Dimensions (mm)			Mass (kg) approx.
				B_3	G_1	B_4	
400	420	23084CAKE4 + AH 3084	Tr 450 x 5	186	34	196	29
	420	24084CAK30E4 + AH 24084	Tr 440 x 5	230	30	252	29.8
	420	23184CAKE4 + AH 3184	Tr 460 x 5	266	40	276	46.5
400	420	24184CAK30E4 + AH 24184	Tr 440 x 5	310	30	332	41.4
	420	23284CAKE4 + AH 3284	Tr 460 x 5	321	46	331	59
	420	23088CAKE4 + AHX 3088	Tr 470 x 5	194	35	205	42
420	440	24088CAK30E4 + AH 24088	Tr 460 x 5	242	30	264	33
	440	23188CAKE4 + AHX 3188	Tr 480 x 5	270	42	281	50
	440	24188CAK30E4 + AH 24188	Tr 460 x 5	310	30	332	43.5
420	440	23288CAKE4 + AHX 3288	Tr 480 x 5	330	48	341	64
	440	23092CAKE4 + AHX 3092	Tr 490 x 5	202	37	213	46
	440	24092CAK30E4 + AH 24092	Tr 480 x 5	250	32	273	35.9
440	460	23192CAKE4 + AHX 3192	Tr 510 x 6	285	43	296	58
	460	24192CAK30E4 + AH 24192	Tr 480 x 5	332	32	355	49.7
	460	23292CAKE4 + AHX 3292	Tr 510 x 6	349	50	360	74.5
460	480	23096CAKE4 + AHX 3096	Tr 520 x 6	205	38	217	51
	480	24096CAK30E4 + AH 24096	Tr 500 x 5	250	32	273	37.5
	480	23196CAKE4 + AHX 3196	Tr 530 x 6	295	45	307	63
480	480	24196CAK30E4 + AH 24196	Tr 500 x 5	340	32	363	53
	480	23296CAKE4 + AHX 3296	Tr 530 x 6	364	52	376	82
	480	230/500CAKE4 + AHX 30/500	Tr 540 x 6	209	40	221	54.5
480	500	240/500CAK30E4 + AH 240/500	Tr 530 x 6	253	35	276	41.9
	500	231/500CAKE4 + AHX 31/500	Tr 550 x 6	313	47	325	71
	500	241/500CAK30E4 + AH 241/500	Tr 530 x 6	360	35	383	61.2
480	500	232/500CAKE4 + AHX 32/500	Tr 550 x 6	393	54	405	94.5

■ NUTS FOR ROLLING BEARINGS

(For Adapters and Shafts)

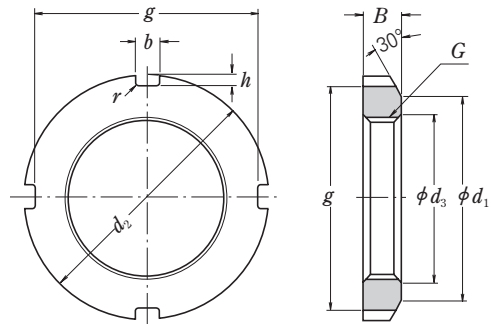

Nut with Washer

Units : mm

Designation	Nut Series AN									Reference			
	Screw Threads <i>G</i>	<i>d</i> ₂	<i>d</i> ₁	<i>g</i>	<i>b</i>	<i>h</i>	<i>d</i> ₃	<i>B</i>	<i>r</i> max.	Mass (kg) approx.	Adapter (1) Sleeve Bore Dia. Numbers	Washer Designation	Shaft Dia.
AN 02	M 15×1	25	21	21	4	2	15.5	5	0.4	0.010	—	AW 02 X	15
AN 03	M 17×1	28	24	24	4	2	17.5	5	0.4	0.013	—	AW 03 X	17
AN 04	M 20×1	32	26	28	4	2	20.5	6	0.4	0.019	04	AW 04 X	20
AN 05	M 25×1.5	38	32	34	5	2	25.8	7	0.4	0.025	05	AW 05 X	25
AN 06	M 30×1.5	45	38	41	5	2	30.8	7	0.4	0.043	06	AW 06 X	30
AN 07	M 35×1.5	52	44	48	5	2	35.8	8	0.4	0.053	07	AW 07 X	35
AN 08	M 40×1.5	58	50	53	6	2.5	40.8	9	0.5	0.085	08	AW 08 X	40
AN 09	M 45×1.5	65	56	60	6	2.5	45.8	10	0.5	0.119	09	AW 09 X	45
AN 10	M 50×1.5	70	61	65	6	2.5	50.8	11	0.5	0.148	10	AW 10 X	50
AN 11	M 55×2	75	67	69	7	3	56	11	0.5	0.158	11	AW 11 X	55
AN 12	M 60×2	80	73	74	7	3	61	11	0.5	0.174	12	AW 12 X	60
AN 13	M 65×2	85	79	79	7	3	66	12	0.5	0.203	13	AW 13 X	65
AN 14	M 70×2	92	85	85	8	3.5	71	12	0.5	0.242	14	AW 14 X	70
AN 15	M 75×2	98	90	91	8	3.5	76	13	0.5	0.287	15	AW 15 X	75
AN 16	M 80×2	105	95	98	8	3.5	81	15	0.6	0.395	16	AW 16 X	80
AN 17	M 85×2	110	102	103	8	3.5	86	16	0.6	0.45	17	AW 17 X	85
AN 18	M 90×2	120	108	112	10	4	91	16	0.6	0.555	18	AW 18 X	90
AN 19	M 95×2	125	113	117	10	4	96	17	0.6	0.66	19	AW 19 X	95
AN 20	M 100×2	130	120	122	10	4	101	18	0.6	0.70	20	AW 20 X	100
AN 21	M 105×2	140	126	130	12	5	106	18	0.7	0.845	21	AW 21 X	105
AN 22	M 110×2	145	133	135	12	5	111	19	0.7	0.965	22	AW 22 X	110
AN 23	M 115×2	150	137	140	12	5	116	19	0.7	1.01	—	AW 23	115
AN 24	M 120×2	155	138	145	12	5	121	20	0.7	1.08	24	AW 24	120
AN 25	M 125×2	160	148	150	12	5	126	21	0.7	1.19	—	AW 25	125

Note (1) Applicable to adapter sleeves in Series A31, A2, A3, or A23.

Remark The basic design and dimensions of screw threads are in accordance with JIS B 0205.

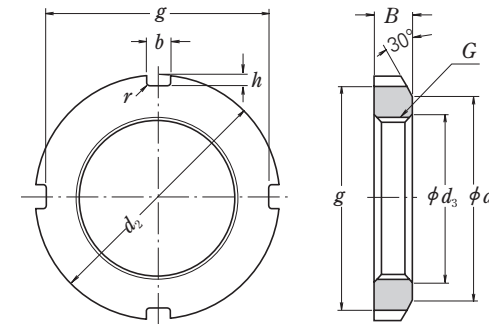

Nut with Washer

Units : mm

Designation	Nut Series AN									Reference			
	Screw Threads <i>G</i>	<i>d</i> ₂	<i>d</i> ₁	<i>g</i>	<i>b</i>	<i>h</i>	<i>d</i> ₃	<i>B</i>	<i>r</i> max.	Mass (kg) approx.	Adapter (1) Sleeve Bore Dia. Numbers	Washer Designation	Shaft Dia.
AN 26	M 130×2	165	149	155	12	5	131	21	0.7	1.25	26	AW 26	130
AN 27	M 135×2	175	160	163	14	6	136	22	0.7	1.55	—	AW 27	135
AN 28	M 140×2	180	160	168	14	6	141	22	0.7	1.56	28	AW 28	140
AN 29	M 145×2	190	172	178	14	6	146	24	0.7	2.0	—	AW 29	145
AN 30	M 150×2	195	171	183	14	6	151	24	0.7	2.03	30	AW 30	150
AN 31	M 155×3	200	182	186	16	7	156.5	25	0.7	2.21	—	—	—
AN 32	M 160×3	210	182	196	16	7	161.5	25	0.7	2.59	32	AW 32	160
AN 33	M 165×3	210	193	196	16	7	166.5	26	0.7	2.43	—	—	—
AN 34	M 170×3	220	193	206	16	7	171.5	26	0.7	2.8	34	AW 34	170
AN 36	M 180×3	230	203	214	18	8	181.5	27	0.7	3.05	36	AW 36	180
AN 38	M 190×3	240	214	224	18	8	191.5	28	0.7	3.4	38	AW 38	190
AN 40	M 200×3	250	226	234	18	8	201.5	29	0.7	3.7	40	AW 40	200
Nut Series ANL													
ANL 24	M 120×2	145	133	135	12	5	121	20	0.7	0.78	24	AWL 24	120
ANL 26	M 130×2	155	143	145	12	5	131	21	0.7	0.88	26	AWL 26	130
ANL 28	M 140×2	165	151	153	14	6	141	22	0.7	0.99	28	AWL 28	140
ANL 30	M 150×2	180	164	168	14	6	151	24	0.7	1.38	30	AWL 30	150
ANL 32	M 160×3	190	174	176	16	7	161.5	25	0.7	1.56	32	AWL 32	160
ANL 34	M 170×3	200	184	186	16	7	171.5	26	0.7	1.72	34	AWL 34	170
ANL 36	M 180×3	210	192	194	18	8	181.5	27	0.7	1.95	36	AWL 36	180
ANL 38	M 190×3	220	202	204	18	8	191.5	28	0.7	2.08	38	AWL 38	190
ANL 40	M 200×3	240	218	224	18	8	201.5	29	0.7	2.98	40	AWL 40	200

Note (1) Series AN is applicable to adapter sleeves in Series A31 or A23.

Series ANL is applicable to adapter sleeves in Series A30.

Remark The basic design and dimensions of screw threads are in accordance with JIS B 0205.

■ NUTS FOR ROLLING BEARINGS

(For Adapters and Shafts)

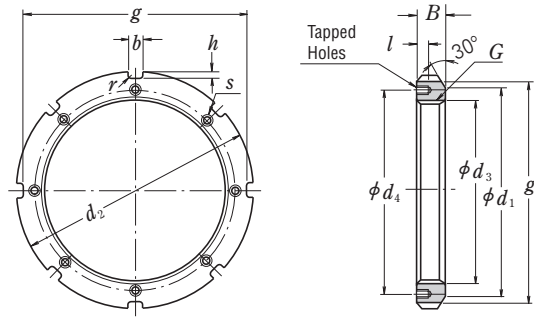

Nut With Stopper

Units : mm

Designation	Nut Series AN											Reference				
	Screw Threads G	d ₂	d ₁	g	b	h	d ₃	B	r max.	l	Tapped Holes Screw Threads (S)	d ₄	Mass (kg) approx.	Adapter (1) Sleeve Bore Dia. Numbers	Stopper Designation	Shaft Dia.
AN 44	Tr 220x4	280	250	260	20	10	222	32	0.8	15	M 8x1.25	238	5.2	44	AL 44	220
AN 48	Tr 240x4	300	270	280	20	10	242	34	0.8	15	M 8x1.25	258	5.95	48	AL 44	240
AN 52	Tr 260x4	330	300	306	24	12	262	36	0.8	18	M 10x1.5	281	8.05	52	AL 52	260
AN 56	Tr 280x4	350	320	326	24	12	282	38	0.8	18	M 10x1.5	301	9.05	56	AL 52	280
AN 60	Tr 300x4	380	340	356	24	12	302	40	0.8	18	M 10x1.5	326	11.8	60	AL 60	300
AN 64	Tr 320x5	400	360	376	24	12	322.5	42	0.8	18	M 10x1.5	345	13.1	64	AL 64	320
AN 68	Tr 340x5	440	400	410	28	15	342.5	55	1	21	M 12x1.75	372	23.1	68	AL 68	340
AN 72	Tr 360x5	460	420	430	28	15	362.5	58	1	21	M 12x1.75	392	25.1	72	AL 68	360
AN 76	Tr 380x5	490	450	454	32	18	382.5	60	1	21	M 12x1.75	414	31	76	AL 76	380
AN 80	Tr 400x5	520	470	484	32	18	402.5	62	1	27	M 16x2	439	37	80	AL 80	400
AN 84	Tr 420x5	540	490	504	32	18	422.5	70	1	27	M 16x2	459	43.5	84	AL 80	420
AN 88	Tr 440x5	560	510	520	36	20	442.5	70	1	27	M 16x2	477	45	88	AL 88	440
AN 92	Tr 460x5	580	540	540	36	20	462.5	75	1	27	M 16x2	497	50.5	92	AL 88	460
AN 96	Tr 480x5	620	560	580	36	20	482.5	75	1	27	M 16x2	527	62	96	AL 96	480
AN 100	Tr 500x5	630	580	584	40	23	502.5	80	1	27	M 16x2	539	63.5	/500	AL 100	500

Nut Series ANL

ANL 44	Tr 220x4	260	242	242	20	9	222	30	0.8	12	M 6x1	229	3.1	44	ALL 44	220
ANL 48	Tr 240x4	290	270	270	20	10	242	34	0.8	15	M 8x1.25	253	5.15	48	ALL 48	240
ANL 52	Tr 260x4	310	290	290	20	10	262	34	0.8	15	M 8x1.25	273	5.65	52	ALL 48	260
ANL 56	Tr 280x4	330	310	310	24	10	282	38	0.8	15	M 8x1.25	293	6.8	56	ALL 56	280
ANL 60	Tr 300x4	360	336	336	24	12	302	42	0.8	15	M 8x1.25	316	9.6	60	ALL 60	300
ANL 64	Tr 320x5	380	356	356	24	12	322.5	42	0.8	15	M 8x1.25	335	9.95	64	ALL 64	320
ANL 68	Tr 340x5	400	376	376	24	12	342.5	45	1	15	M 8x1.25	355	11.7	68	ALL 64	340
ANL 72	Tr 360x5	420	394	394	28	13	362.5	45	1	15	M 8x1.25	374	12	72	ALL 72	360
ANL 76	Tr 380x5	450	422	422	28	14	382.5	48	1	18	M 10x1.5	398	14.9	76	ALL 76	380
ANL 80	Tr 400x5	470	442	442	28	14	402.5	52	1	18	M 10x1.5	418	16.9	80	ALL 76	400
ANL 84	Tr 420x5	490	462	462	32	14	422.5	52	1	18	M 10x1.5	438	17.4	84	ALL 84	420
ANL 88	Tr 440x5	520	490	490	32	15	442.5	60	1	21	M 12x1.75	462	26.2	88	ALL 88	440
ANL 92	Tr 460x5	540	510	510	32	15	462.5	60	1	21	M 12x1.75	482	28	92	ALL 88	460
ANL 96	Tr 480x5	560	530	530	36	15	482.5	60	1	21	M 12x1.75	502	29.5	96	ALL 96	480
ANL 100	Tr 500x5	580	550	550	36	15	502.5	68	1	21	M 12x1.75	522	33.5	/500	ALL 96	500

Note (1) Series AN is applicable to adapter sleeves in Series A31, A32, and A23. Series ANL is applicable to adapter sleeves in Series A30.

Remarks 1. The basic design and dimensions of screw threads are in accordance with JIS B 0216.
2. The basic design and dimensions of threads in tapped holes are in accordance with JIS B 0205.

(For Withdrawal Sleeves)

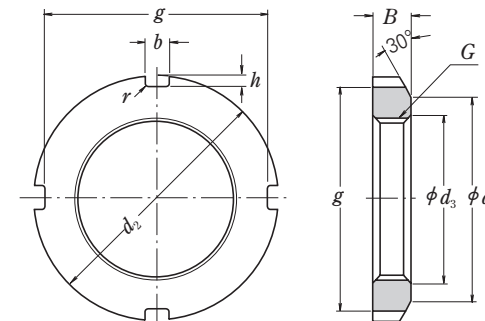

Units : mm

Designation	Nut Series HN											Reference			
	Screw Threads G	d ₂	d ₁	g	b	h	d ₃	B	r max.	Mass (kg) approx.	Withdrawal Sleeve Designations				
											AH 31	AH 22	AH 32	AH 23	
HN 42	Tr 210x4	270	238	250	20	10	212	30	0.8	4.75	AH 3138	AH 2238	AH 3238	AH 2338	
HN 44	Tr 220x4	280	250	260	20	10	222	32	0.8	5.35	AH 3140	AH 2240	AH 3240	AH 2340	
HN 48	Tr 240x4	300	270	280	20	10	242	34	0.8	6.2	AH 3144	AH 2244	—	AH 2344	
HN 52	Tr 260x4	330	300	306	24	12	262	36	0.8	8.55	AH 3148	AH 2248	—	AH 2348	
HN 58	Tr 290x4	370	330	346	24	12	292	40	0.8	11.8	AH 3152	AH 2252	—	AH 2352	
HN 62	Tr 310x5	390	350	366	24	12	312.5	42	0.8	13.4	AH 3156	AH 2256	—	AH 2356	
HN 66	Tr 330x5	420	380	390	28	15	332.5	52	1	20.4	AH 3160	AH 2260	AH 3260	—	
HN 70	Tr 350x5	450	410	420	28	15	352.5	55	1	25.2	AH 3164	AH 2264	AH 3264	—	
HN 74	Tr 370x5	470	430	440	28	15	372.5	58	1	28.2	AH 3168	—	AH 3268	—	
HN 80	Tr 400x5	520	470	484	32	18	402.5	62	1	40	AH 3172	—	AH 3272	—	
HN 84	Tr 420x5	540	490	504	32	18	422.5	70	1	46.9	AH 3176	—	AH 3276	—	
HN 88	Tr 440x5	560	510	520	36	20	442.5	70	1	48.5	AH 3180	—	AH 3280	—	
HN 92	Tr 460x5	580	540	540	36	20	462.5	75	1	55	AH 3184	—	AH 3284	—	
HN 96	Tr 480x5	620	560	580	36	20	482.5	75	1	67	AHX 3188	—	AHX 3288	—	
HN 102	Tr 510x6	650	590	604	40	23	513	80	1	75	AHX 3192	—	AHX 3292	—	
HN 106	Tr 530x6	670	610	624	40	23	533	80	1	78	AHX 3196	—	AHX 3296	—	
HN 110	Tr 550x6	700	640	654	40	23	553	80	1	92.5	AHX 31/500	—	AHX 32/500	—	

Nut Series HNL

HNL41	Tr 205x4	250	232	234	18	8	207	30	0.8	3.45	AH 3038	AH 238	—	—
HNL43	Tr 215x4	260	242	242	20	9	217	30	0.8	3.7	AH 3040	AH 240	—	—
HNL47	Tr 235x4	280	262	262	20	9	237	34	0.8	4.6	AH 3044	AH 244	—	—
HNL52	Tr 260x4	310	290	290	20	10	262	34	0.8	5.8	AH 3048	AH 248	—	—
HNL56	Tr 280x4	330	310	310	24	10	282	38	0.8	6.7	AH 3052	AH 252	—	—
HNL60	Tr 300x4	360	336	336	24	12	302	42	0.8	9.6	AH 3056	AH 256	—	—
HNL64	Tr 320x5	380	356	356	24	12	322.5	42	1	10.3	AH 3060	—	—	—
HNL69	Tr 345x5	410	384	384	28	13	347.5	45	1	11.5	AH 3064	—	—	—
HNL73	Tr 365x5	430	404	404	28	13	367.5	48	1	14.2	AH 3068	—	—	—
HNL77	Tr 385x5	450	422	422	28	14	387.5	48	1	15	AH 3072	—	—	—
HNL82	Tr 410x5	480	452	452	32	14	412.5	52	1	19	AH 3076	—	—	—
HNL86	Tr 430x5	500	472	472	32	14	432.5	52	1	19.8	AH 3080	—	—	—
HNL90	Tr 450x5	520	490	490	32	15	452.5	60	1	23.8	AH 3084	—	—	—
HNL94	Tr 470x5	540	510	510	32	15	472.5	60	1	25	AHX 3088	—	—	—
HNL98	Tr 490x5	580	550	550	36	15	492.5	60	1	34	AHX 3092	—	—	—
HNL 104	Tr 520x6	600	570	570	36	15	523	68	1	37	AHX 3096	—	—	—
HNL 108	Tr 540x6	630	590	590	40	20	543	68	1	43.5	AHX 30/500	—	—	—

Remarks 1. The basic design and dimensions of screw threads are in accordance with JIS B 0216.
2. There may be more notches in the nut than shown in the above figure.

■ NUTS FOR ROLLING BEARINGS

(Combination of Withdrawal Sleeves and Nuts)

Designation	Reference						
	Withdrawal Sleeve Designations						
	AH 30	AH 31	AH 2	AH 22	AH 32	AH 3	AH 23
AN 09	—	—	AH 208	—	—	AH 308	AH 2308
AN 10	—	—	AH 209	—	—	AH 309	AH 2309
AN 11	—	—	AH 210	—	—	AHX 310	AHX 2310
AN 12	—	—	AH 211	—	—	AHX 311	AHX 2311
AN 13	—	—	AH 212	—	—	AHX 312	AHX 2312
AN 14	—	—	—	—	—	—	—
AN 15	—	—	AH 213	—	—	AH 313	AH 2313
AN 16	—	—	AH 214	—	—	AH 314	AHX 2314
AN 17	—	—	AH 215	—	—	AH 315	AHX 2315
AN 18	—	—	AH 216	—	—	AH 316	AHX 2316
AN 19	—	—	AH 217	—	—	AHX 317	AHX 2317
AN 20	—	—	AH 218	—	AHX 3218	AHX 318	AHX 2318
AN 21	—	—	AH 219	—	—	AHX 319	AHX 2319
AN 22	—	—	AH 220	—	AHX 3220	AHX 320	AHX 2320
AN 23	—	—	AH 221	—	—	AHX 321	—
AN 24	—	AHX 3122	AH 222	—	—	AHX 322	—
AN 25	—	—	—	—	AHX 3222	—	AHX 2322
AN 26	AHX 3024	AHX 3124	AH 224	—	—	AHX 324	—
AN 27	—	—	—	—	AHX 3224	—	AHX 2324
AN 28	AHX 3026	AHX 3126	AH 226	—	—	AHX 326	—
AN 29	—	—	—	—	AHX 3226	—	AHX 2326
AN 30	AHX 3028	AHX 3128	AH 228	—	—	AHX 328	—
AN 31	—	—	—	—	AHX 3228	—	AHX 2328
AN 32	AHX 3030	—	AH 230	—	—	—	—
AN 33	—	AHX 3130	—	—	AHX 3230	AHX 330	AHX 2330
AN 34	AH 3032	—	AH 232	—	—	—	—
AN 36	AH 3034	AH 3132	AH 234	—	AH 3232	AH 332	AH 2332
AN 38	AH 3036	AH 3134	AH 236	—	AH 3234	AH 334	AH 2334
AN 40	—	AH 3136	—	AH 2236	AH 3236	—	AH 2336

■ STOPPERS FOR ROLLING BEARINGS

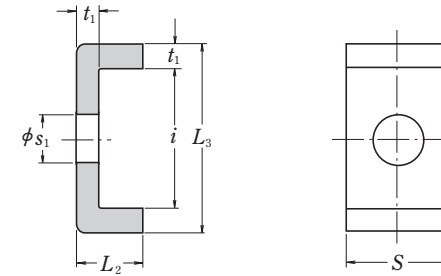

Units : mm

Designation	Stopper Series AL						Mass (kg) per 100 pcs approx.	Reference Nut Designations
	Basic Dimensions							
	t_1	S	L_2	s_1	i	L_3		
AL 44	4	20	12	9	22.5	30.5	2.6	AN 44, AN 48 AN 52, AN 56 AN 60
AL 52	4	24	12	12	25.5	33.5	3.4	
AL 60	4	24	12	12	30.5	38.5	3.8	
AL 64	5	24	15	12	31	41	5.35	AN 64 AN 68, AN 72 AN 76
AL 68	5	28	15	14	38	48	6.65	
AL 76	5	32	15	14	40	50	7.95	
AL 80	5	32	15	18	45	55	8.2	AN 80, AN 84 AN 88, AN 92 AN 96 AN 100
AL 88	5	36	15	18	43	53	9.0	
AL 96	5	36	15	18	53	63	10.4	
AL 100	5	40	15	18	45	55	10.5	

Designation	Stopper Series ALL						Mass (kg) per 100 pcs approx.	Reference Nut Designations
	Basic Dimensions							
	t_1	S	L_2	s_1	i	L_3		
ALL 44	4	20	12	7	13.5	21.5	2.12	ANL 44 ANL 48, ANL 52 ANL 56
ALL 48	4	20	12	9	17.5	25.5	2.29	
ALL 56	4	24	12	9	17.5	25.5	2.92	
ALL 60	4	24	12	9	20.5	28.5	3.15	ANL 60 ANL 64, ANL 68 ANL 72
ALL 64	5	24	15	9	21	31	4.55	
ALL 72	5	28	15	9	20	30	5.05	
ALL 76	5	28	15	12	24	34	5.3	ANL 76, ANL 80 ANL 84 ANL 88, ANL 92 ANL 96, ANL 100
ALL 84	5	32	15	12	24	34	6.1	
ALL 88	5	32	15	14	28	38	6.45	
ALL 96	5	36	15	14	28	38	7.3	

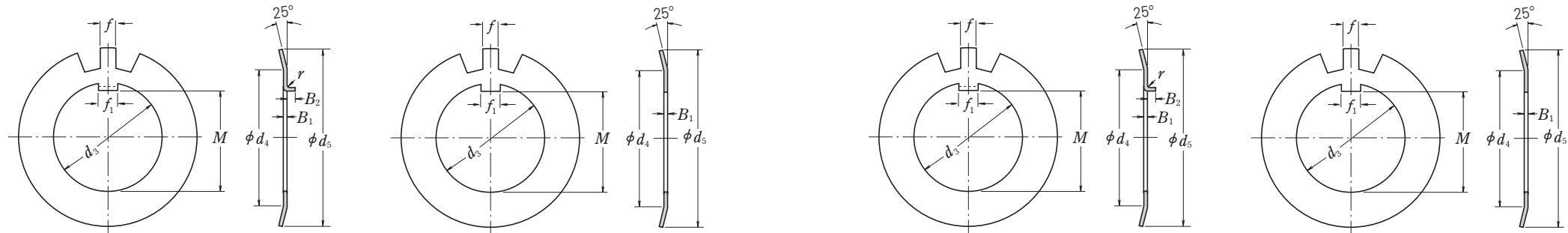

Bent-Tab

Straight-Tab

Bent-Tab

Straight-Tab

Units : mm

Units : mm

Designation		Lock-Washer Series AW										Reference			
Bent-Tab	Straight-Tab	Basic Dimensions								No. of Teeth	Mass (kg) per 100 pcs approx.	Adapter (1) Sleeve Bore Dia. Numbers	Nut Designation	Shaft Dia.	
		d_3	M	f_1	B_1	f	d_4	d_5	Bent-Tab r						Straight-Tab B_2
AW 02	AW 02 X	15	13.5	4	1	4	21	28	1	2.5	13	0.253	—	AN 02	15
AW 03	AW 03 X	17	15.5	4	1	4	24	32	1	2.5	13	0.315	—	AN 03	17
AW 04	AW 04 X	20	18.5	4	1	4	26	36	1	2.5	13	0.35	04	AN 04	20
AW 05	AW 05 X	25	23	5	1.2	5	32	42	1	2.5	13	0.64	05	AN 05	25
AW 06	AW 06 X	30	27.5	5	1.2	5	38	49	1	2.5	13	0.78	06	AN 06	30
AW 07	AW 07 X	35	32.5	6	1.2	5	44	57	1	2.5	15	1.04	07	AN 07	35
AW 08	AW 08 X	40	37.5	6	1.2	6	50	62	1	2.5	15	1.23	08	AN 08	40
AW 09	AW 09 X	45	42.5	6	1.2	6	56	69	1	2.5	17	1.52	09	AN 09	45
AW 10	AW 10 X	50	47.5	6	1.2	6	61	74	1	2.5	17	1.6	10	AN 10	50
AW 11	AW 11 X	55	52.5	8	1.2	7	67	81	1	4	17	1.96	11	AN 11	55
AW 12	AW 12 X	60	57.5	8	1.5	7	73	86	1.2	4	17	2.53	12	AN 12	60
AW 13	AW 13 X	65	62.5	8	1.5	7	79	92	1.2	4	19	2.9	13	AN 13	65
AW 14	AW 14 X	70	66.5	8	1.5	8	85	98	1.2	4	19	3.35	14	AN 14	70
AW 15	AW 15 X	75	71.5	8	1.5	8	90	104	1.2	4	19	3.55	15	AN 15	75
AW 16	AW 16 X	80	76.5	10	1.8	8	95	112	1.2	4	19	4.65	16	AN 16	80
AW 17	AW 17 X	85	81.5	10	1.8	8	102	119	1.2	4	19	5.25	17	AN 17	85
AW 18	AW 18 X	90	86.5	10	1.8	10	108	126	1.2	4	19	6.25	18	AN 18	90
AW 19	AW 19 X	95	91.5	10	1.8	10	113	133	1.2	4	19	6.7	19	AN 19	95
AW 20	AW 20 X	100	96.5	12	1.8	10	120	142	1.2	6	19	7.65	20	AN 20	100
AW 21	AW 21 X	105	100.5	12	1.8	12	126	145	1.2	6	19	8.25	21	AN 21	105
AW 22	AW 22 X	110	105.5	12	1.8	12	133	154	1.2	6	19	9.4	22	AN 22	110
AW 23	AW 23 X	115	110.5	12	2	12	137	159	1.5	6	19	10.8	—	AN 23	115
AW 24	AW 24 X	120	115	14	2	12	138	164	1.5	6	19	10.5	24	AN 24	120
AW 25	AW 25 X	125	120	14	2	12	148	170	1.5	6	19	11.8	—	AN 25	125

Note (1) Applicable to adapter sleeves in Series A31, A2, A3, and A23.

Remark Lock-washers with straight tabs must be used for adapter sleeves with narrow slits, while either type of lock-washer may be used for those with wide slits.

Designation		Lock-Washer Series AW										Reference			
Bent-Tab	Straight-Tab	Basic Dimensions								No. of Teeth	Mass (kg) per 100 pcs approx.	Adapter (1) Sleeve Bore Dia. Numbers	Nut Designation	Shaft Dia.	
		d_3	M	f_1	B_1	f	d_4	d_5	Bent-Tab r						Straight-Tab B_2
AW 26	AW 26 X	130	125	14	2	12	149	175	1.5	6	19	11.3	26	AN 26	130
AW 27	AW 27 X	135	130	14	2	14	160	185	1.5	6	19	14.4	—	AN 27	135
AW 28	AW 28 X	140	135	16	2	14	160	192	1.5	8	19	14.2	28	AN 28	140
AW 29	AW 29 X	145	140	16	2	14	172	202	1.5	8	19	16.8	—	AN 29	145
AW 30	AW 30 X	150	145	16	2	14	171	205	1.5	8	19	15.9	30	AN 30	150
AW 31	AW 31 X	155	147.5	16	2.5	16	182	212	1.5	8	19	20.9	—	AN 31	155
AW 32	AW 32 X	160	154	18	2.5	16	182	217	1.5	8	19	22.2	32	AN 32	160
AW 33	AW 33 X	165	157.5	18	2.5	16	193	222	1.5	8	19	24.1	—	AN 33	165
AW 34	AW 34 X	170	164	18	2.5	16	193	232	1.5	8	19	24.7	34	AN 34	170
AW 36	AW 36 X	180	174	20	2.5	18	203	242	1.5	8	19	26.8	36	AN 36	180
AW 38	AW 38 X	190	184	20	2.5	18	214	252	1.5	8	19	27.8	38	AN 38	190
AW 40	AW 40 X	200	194	20	2.5	18	226	262	1.5	8	19	29.3	40	AN 40	200

Washer Series AWL

AWL 24	AWL 24 X	120	115	14	2	12	133	155	1.5	6	19	7.7	24	ANL 24	120
AWL 26	AWL 26 X	130	125	14	2	12	143	165	1.5	6	19	8.7	26	ANL 26	130
AWL 28	AWL 28 X	140	135	16	2	14	151	175	1.5	8	19	10.9	28	ANL 28	140
AWL 30	AWL 30 X	150	145	16	2	14	164	190	1.5	8	19	11.3	30	ANL 30	150
AWL 32	AWL 32 X	160	154	18	2.5	16	174	200	1.5	8	19	16.2	32	ANL 32	160
AWL 34	AWL 34 X	170	164	18	2.5	16	184	210	1.5	8	19	19	34	ANL 34	170
AWL 36	AWL 36 X	180	174	20	2.5	18	192	220	1.5	8	19	18	36	ANL 36	180
AWL 38	AWL 38 X	190	184	20	2.5	18	202	230	1.5	8	19	20.5	38	ANL 38	190
AWL 40	AWL 40 X	200	194	20	2.5	18	218	250	1.5	8	19	21.4	40	ANL 40	200

Note (1) Series AW is applicable to adapter sleeves in Series A31 and A23. Series AWL is applicable to adapter sleeves in Series A30.

Remark Lock-washers with straight tabs must be used for adapter sleeves with narrow slits, while either type of lock-washer may be used for those with wide slits.

INDUSTRY SOLUTIONS

Part D

INDUSTRY SOLUTIONS

- 1. AIR TURBINE BEARINGS FOR DENTAL HANDPIECES D 004
- 2. PUMPS & COMPRESSORS D 010
- 3. AGRICULTURAL MACHINERY D 026
- 4. CONSTRUCTION MACHINERY D 034
- 5. MINING MACHINERY D 040
- 6. RAILWAY ROLLING STOCK D 048
- 7. PAPERMAKING MACHINES D 066
- 8. WIND POWER INDUSTRY D 086
- 9. STEEL INDUSTRY D 094



Note (*1): Photo courtesy of NIPPON STEEL & SUMITOMO METAL CORPORATION KASHIMA WORKS pamphlet.

Air Turbine Bearings for Dental Handpieces

Greatly improved corrosion resistance
lengthens bearing replacement cycles.



Features of Dental Handpiece Bearings D 006

Formulation of Bearing Designations D 007

Lineup D 008

Dental Handpiece Bearings

Features of NSK Dental Handpiece Bearings

This bearing Series has been developed to cover the wide range of handpiece sizes and shapes used in the market (43 types in total).

Bearing Type

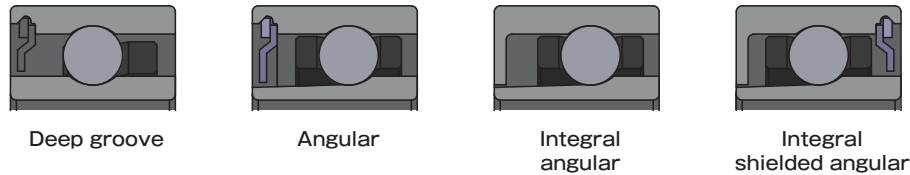

Shape

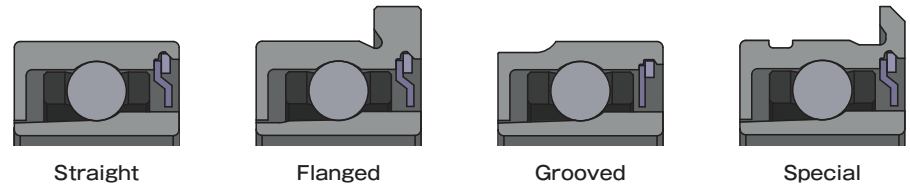

Long-Life Bearings With Highly Corrosion-Resistant ES1 Stainless Steel

NSK has developed a highly corrosion-resistant material called ES1 that is highly suitable for manufacturing dental handpiece bearings. ES1 has made it possible to improve the life of bearings significantly and assure highly effective sterilization with no cross contamination. ES1 offers corrosion resistance far superior to conventional SUS440C stainless steel bearings. Electrical and chemical tests of our anodic polarization measurement confirm that the current density (corrosion rate) in the passive state range of ES1 bearings is about one-tenth lower than conventional stainless steel bearings, demonstrating ES1's superior corrosion resistance.

Ultra-High-Speed Rotation

To maintain ultra-high-speed rotation and the long rolling life of air turbine bearings, NSK makes continuous efforts to optimize the design and improve the precision of cage parts. As a result, we have been successful in maintaining stable rotation even at 500,000 rpm.

Formulation of Bearing Designations

Please use the following example designation for an NSK standard dental handpiece bearing (Straight 100 Series) as a guide to select a bearing according to requirements such as bearing width, material, and lubricant.

B3Z100X -H-20SN34 T52C ZS CG9 7A U438 CF1X

(1) (2) (3) (4) (5) (6) (7) (8)

- (1) **B3Z100X:** Model name indicating basic designation for air turbines
- (2) **-H-20SN34:** Ceramic balls (-H-26: Optional stainless steel balls)
- (3) **T52C:** Torlon® polyamide-imide cage
C, J, P, etc.: Cage type
- (4) **ZS:** Single shield
- (5) **CG9:** RIC 0.008mm to 0.010mm (Recommended by NSK)
- (6) **7A:** Special tolerance class (ABEC7+ID: ABEC9)
- (7) **U438:** Special specification for air turbine
- (8) **CF1X:** Special oil (food grade) or **BF7N:** Special grease

Importance of a Perfect Fitting

For optimal performance, bearings must be correctly fitted on the shaft and in the housing. To provide this performance, Class ABEC9 tolerance (from -0.0025 mm to 0 mm) is used for the inner ring bore of NSK bearings. NSK can supply bearings with two classifications of ring bore diameter tolerance (from -0.0025 to -0.00125 mm and from -0.00125 to 0 mm). This choice makes it easy to stabilize the bearing fitting. A stable fitting reduces air turbine vibrations, noise, and irregularities in the revolutions per minute, thereby assuring long life.

• Shaft material: martensitic stainless steel (SUS400 family)

(Please contact NSK when using bearings for stainless steel shafts made of materials other than martensitic stainless steel.)

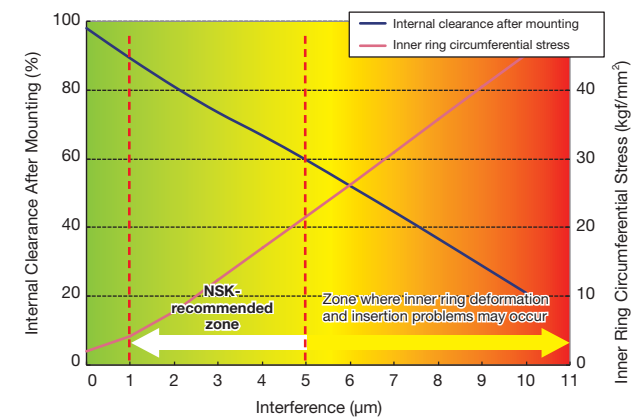

Dental Handpiece Bearings

Lineup

Bearing Series	Width	Deep Groove Bearing	Angular Contact Bearing		Integral Bearing			
			Inner Ring Counterbore	Outer Ring Counterbore	Inner Ring Counterbore		Outer Ring Counterbore	
100 Series (Straight type) 	2.380mm (0.0937")	 B3Z-100X	 BH3Z-101X	 BH3Z-102X	 BH3Z-103X		 BH3Z-104X	
	2.779mm (0.1094")	 B3Z-100	 BH3Z-101A	 BH3Z-102A	 BH3Z-103A	 BH3Z-103B	 BH3Z-104A	 BH3Z-104
150 Series (Grooved type) 	2.380mm (0.0937")	 B3Z-150X	 BH3Z-151X	 BH3Z-152X	 BH3Z-153X		 BH3Z-154X	
	2.779mm (0.1094")	 B3Z-150	 BH3Z-151A	 BH3Z-152A	 BH3Z-153A	 BH3Z-153B	 BH3Z-154A	 BH3Z-154
200 Series (Flanged type) 	2.380mm (0.0937")	 FBC3Z-200X	 FBH3Z-201X	 FBH3Z-202X	 FBH3Z-203X		 FBH3Z-204X	
	2.779mm (0.1094")	 FBC3Z-200	 FBH3Z-201A	 FBH3Z-202A	 FBH3Z-203A	 FBH3Z-203B	 FBH3Z-204A	 FBH3Z-204
250 Series 	2.779mm (0.1094")	 FBC3Z-250	 FBH3Z-251A	 FBH3Z-252A	 FBH3Z-253A	 FBH3Z-253B	 FBH3Z-254A	 FBH3Z-254

Standard Specifications

- Ceramic balls
- ABEC9(P2) grade tolerance is used for the inner ring bore diameter for maximum bearing performance. The tolerance of other parts is ABEC7(P4) grade.
- NSK can supply bearings with two classifications of the inner ring bore diameter tolerance (from -0.0025 to -0.00125, and from -0.00125 to 0mm).
- Custom laser markings are available upon request.
- Highly safe, low-viscosity CG1 oil is standard in NSK dental handpiece bearings. Bearings with BF7 grease are also available.

Optional Specifications

- Stainless steel ball bearings are also available.
- Bearings with different widths for the outer ring and inner ring are also available.

Preload Stabilization

Stabilization of preload with a spring is extremely important for air turbine bearings. There are three management points ((1) to (3) below) for this task. Bearing assembly height is also a vital factor when applying preload. NSK can verify the configuration of your bearing assembly height to assure stable preloading.

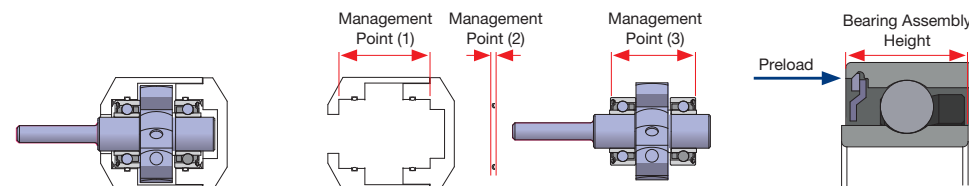

Bearings for Pumps & Compressors

High-performance, reliable bearings that deliver long life and energy-efficient operation.

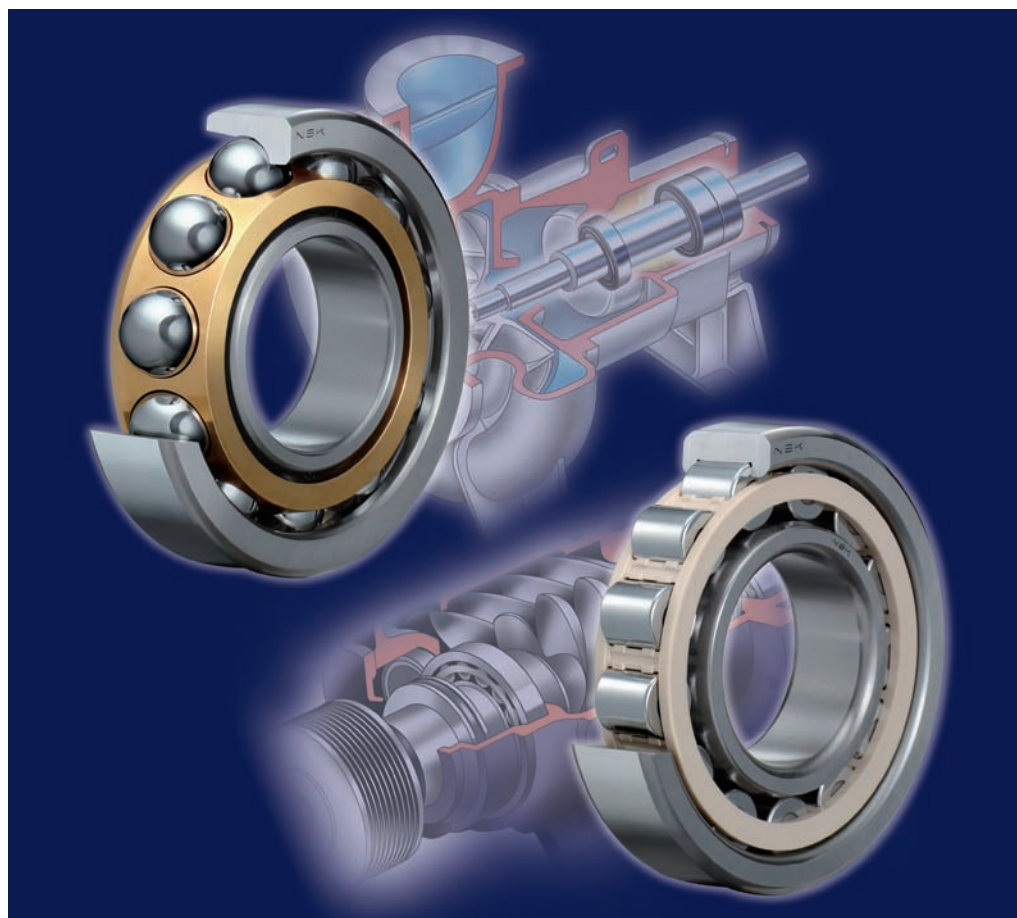

Bearings for Pumps

Bearing Tables

NSKHPS™ / High Load Capacity Single-Row Angular Contact Ball Bearings

Bore Diameter 20 – 120 mm D 015

High Load Capacity Double-Row Angular Contact Ball Bearings

Bore Diameter 25 – 65 mm D 016

High Load Capacity Deep Groove Ball Bearings (Open)

Bore Diameter 15 – 60 mm D 017

Creep-Free Bearings™

Bore Diameter 10 – 45 mm D 018

Bearings for Compressors

Bearing Tables

High Load Capacity Cylindrical Roller Bearings (L-PPS Cage)

Bore Diameter 20 – 100 mm D 022

NSKHPS™ Angular Contact Ball Bearings (L-PPS Cage)

Bore Diameter 12 – 80 mm D 024

High-Speed Cylindrical Roller Bearings

Bore Diameter 25 – 50 mm D 025

High-Speed Angular Contact Ball Bearings

Bore Diameter 20 – 50 mm D 025

Bearings for Pumps

Advanced machined-brass cages provide strength and endurance. Optimized internal geometries allow efficient lubricant flow through the bearing.

Vacuum Pumps

High Load Capacity Deep Groove Ball Bearings

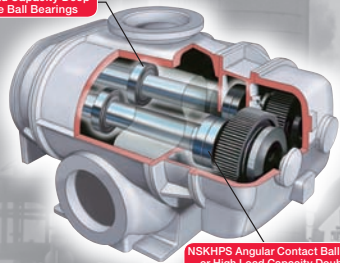

NSKHPS Angular Contact Ball Bearings, or High Load Capacity Double-Row Angular Contact Ball Bearings

Pumps for Petroleum and Chemicals

NSKHPS Angular Contact Ball Bearings

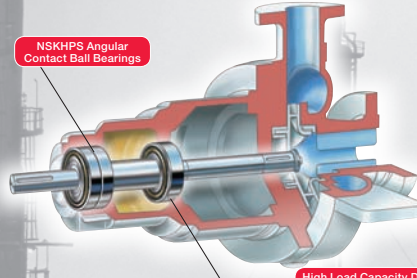

High Load Capacity Deep Groove Ball Bearings

Slurry Pumps

NSKHPS Angular Contact Ball Bearings

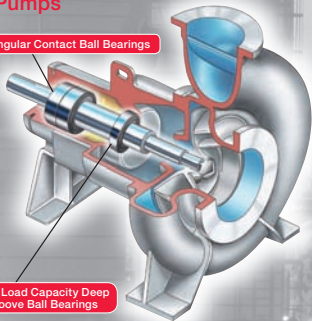

High Load Capacity Deep Groove Ball Bearings

General Pumps

High Load Capacity Deep Groove Ball Bearings

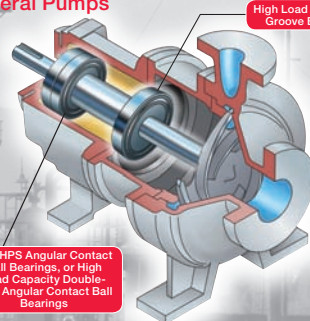

NSKHPS Angular Contact Ball Bearings, or High Load Capacity Double-Row Angular Contact Ball Bearings

Submerged Pumps

Creep-Free Bearings

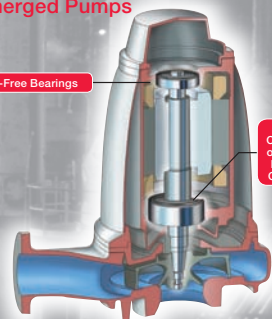

NSKHPS Angular Contact Ball Bearings, or High Load Capacity Double-Row Angular Contact Ball Bearings

Features of Bearings for Pumps



NSKHPS™ / High Load Capacity Single-Row Angular Contact Ball Bearings

- High load capacity angular contact ball bearings with machined-brass cages.
- Improved bearing life (up to 90% longer) over conventional bearings reduces maintenance frequency and improves reliability.

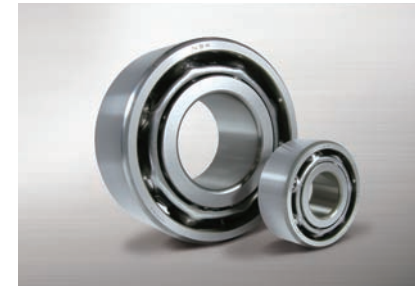

High Load Capacity Double-Row Angular Contact Ball Bearings

- High load capacity double-row angular contact ball bearings have advanced internal bearing geometry.
- Improved bearing life (up to 50% longer) over conventional bearings reduces maintenance frequency and improves reliability.



High Load Capacity Deep Groove Ball Bearings (Open Type)

- Open high load capacity deep groove ball bearings with advanced internal bearing geometry.
- Improved bearing life (up to 70% longer) over conventional bearings reduces maintenance frequency and improves reliability.

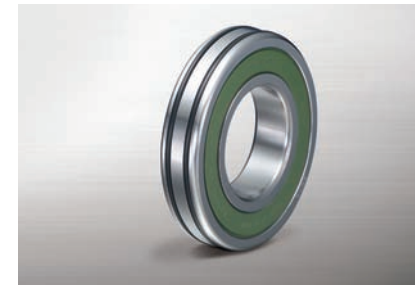

Creep-Free Bearings™

- Outer ring creep prevention is significantly improved with O-ring tension in the housing.
- Standard principal dimensions are maintained to eliminate the need for re-machining housings. These bearings are suitable for the free side of the motor in motor-integrated pumps.

Features of Bearings for Pumps

NSKHPS™ / High Load Capacity Single-Row Angular Contact Ball Bearings

- Applications**
- Petroleum and Chemical industries (API standards¹, etc.)
 - Pulp and paper industry (ANSI standards², etc.)
- *1 Standards related to petroleum specified by the American Petroleum Institute
 *2 Standards of industrial products in the U.S. specified by the American National Standards Institute

High load capacity and outstanding lubrication performance enable reduced pump size and extended maintenance intervals.

- Compared to conventional bearings:
- Bearing life: 90% longer
 - Maximum rotational speed: 20% faster
 - Universal arrangement standard
 - 40° contact angle

Axial Internal Clearance in Combined ACBBs (Measured Clearance)

Nominal Bore Diameter <i>d</i> (mm)		CNB		GA	
Over	Incl.	Min.	Max.	Min.	Max.
12	18	17	25	-2	6
18	30	20	28		
30	50	24	32		
50	80	29	41	-3	9

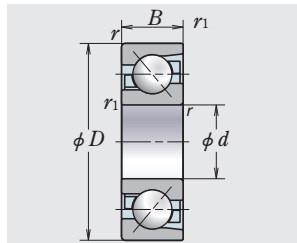

Bearing Designation

Example: **7310 B EA MR SU GA**

- Basic designation: 7310
- Contact angle: 40°
- Internal designation: High load capacity
- Cage: Machined cage
- Arrangement: Universal arrangement (single unit)
- Internal clearance

Bearing Designation	Boundary Dimensions (mm)					Basic Load Ratings (N)		Limiting Speeds (min ⁻¹)	
	<i>d</i>	<i>D</i>	<i>B</i>	<i>r</i> (min.)	<i>r</i> ₁ (min.)	<i>C</i> _r	<i>C</i> _{0r}	Grease	Oil
*7304BEA	20	52	15	1.1	0.6	19 800	10 500	13 000	18 000
*7305BEA	25	62	17	1.1	0.6	27 200	14 900	10 000	15 000
*7206BEA	30	62	16	1	0.6	23 700	14 300	10 000	14 000
*7306BEA	30	72	19	1.1	0.6	36 500	20 600	9 000	13 000
*7207BEA	35	72	17	1.1	0.6	32 500	19 600	8 500	12 000
*7307BEA	35	80	21	1.5	1	40 500	24 400	8 000	11 000
*7208BEA	40	80	18	1.1	0.6	38 500	24 500	7 500	11 000
*7308BEA	40	90	23	1.5	1	53 000	33 000	7 100	10 000
*7209BEA	45	85	19	1.1	0.6	40 500	27 100	7 100	10 000
*7309BEA	45	100	25	1.5	1	62 500	39 500	6 300	9 000
*7210BEA	50	90	20	1.1	0.6	42 000	29 700	6 300	9 500
*7310BEA	50	110	27	2	1	78 000	50 500	5 600	8 000
*7211BEA	55	100	21	1.5	1	51 500	37 000	6 000	8 500
*7311BEA	55	120	29	2	1	89 000	58 500	5 000	7 500
*7212BEA	60	110	22	1.5	1	61 500	45 000	5 300	7 500
*7312BEA	60	130	31	2.1	1.1	102 000	68 500	4 800	6 700
*7213BEA	65	120	23	1.5	1	70 000	53 500	4 800	7 100
*7313BEA	65	140	33	2.1	1.1	114 000	77 000	4 300	6 300
*7214BEA	70	125	24	1.5	1	75 500	58 500	4 500	6 700
*7314BEA	70	150	35	2.1	1.1	124 000	87 500	4 000	6 000
*7215BEA	75	130	25	1.5	1	78 500	63 500	4 300	6 300
*7315BEA	75	160	37	2.1	1.1	134 000	98 500	3 800	5 600
*7216BEA	80	140	26	2	1	87 500	70 000	4 000	6 000
*7316BEA	80	170	39	2.1	1.1	144 000	110 000	3 600	5 300
7217BEA	85	150	28	2	1	96 000	81 500	3 800	5 600
7317BEA	85	180	41	3	1.1	157 000	133 000	3 400	5 000
7218BEA	90	160	30	2	1	109 000	93 500	3 600	5 300
7318BEA	90	190	43	3	1.1	169 000	146 000	3 200	4 500
7219BEA	95	170	32	2.1	1.1	123 000	107 000	3 400	5 000
7319BEA	95	200	45	3	1.1	180 000	160 000	3 000	4 500
7220BEA	100	180	34	2.1	1.1	136 000	122 000	3 200	4 500
7320BEA	100	215	47	3	1.1	202 000	187 000	2 800	4 000
7221BEA	105	190	36	2.1	1.1	148 000	133 000	3 000	4 500
7321BEA	105	225	49	3	1.1	213 000	203 000	2 600	4 000
7222BEA	110	200	38	2.1	1.1	154 000	144 000	2 800	4 300
7322BEA	110	240	50	3	1.1	226 000	226 000	2 600	3 800
7224BEA	120	215	40	2.1	1.1	179 000	177 000	2 600	3 800
7324BEA	120	260	55	3	1.1	238 000	250 000	2 200	3 400

Remarks

*These NSKHPS angular contact ball bearings feature ISO tolerance Class 5 running accuracy and ISO tolerance Class 6 dimensional accuracy.

Bearings without an asterisk are high load capacity angular contact ball bearings with P6 running accuracy and P6 dimensional accuracy.

Air Turbine Dental Handpieces
 Pumps & Compressors
 Agricultural Machinery
 Construction Machinery
 Mining Machinery
 Railway Rolling Stock
 Papermaking Machines
 Wind Power Industry
 Steel Industry
 Air Turbine Dental Handpieces
 Pumps & Compressors
 Agricultural Machinery
 Construction Machinery
 Mining Machinery
 Railway Rolling Stock
 Papermaking Machines
 Wind Power Industry
 Steel Industry

Air Turbine Dental Handpieces
 Pumps & Compressors
 Agricultural Machinery
 Construction Machinery
 Mining Machinery
 Railway Rolling Stock
 Papermaking Machines
 Wind Power Industry
 Steel Industry

■ Features of Bearings for Pumps

High Load Capacity Double-Row Angular Contact Ball Bearings

- Applications
- Pulp and paper industry (ANSI standards, etc.)
 - Water/Sewage and Irrigation, etc.

Improved bearing life and thrust load capacity enable reduced pump size and extended maintenance intervals.

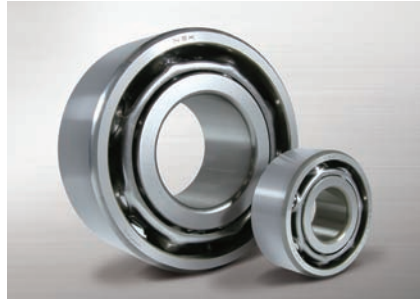

Compared to conventional bearings:

- Bearing life: 50% longer
- Thrust load capacity: Twice as high as conventional bearings
- Improved installation with advanced lead-in chamfer
- Class P6 as standard

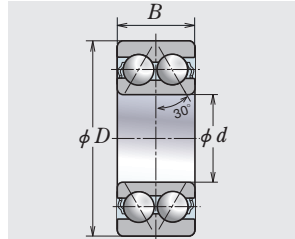

Bearing Designation

Example: **3309 F CGXX**

Basic Designation: 3309
 Contact angle: 30°
 Radial internal clearance: CGXX

Bearing Designation	Boundary Dimensions (mm)			Basic Load Ratings (N)	
	<i>d</i>	<i>D</i>	<i>B</i>	<i>C_r</i> (dynamic)	<i>C_{0r}</i> (static)
3305F	25	62	25.4	30 500	20 500
3306F	30	72	30.2	39 500	27 300
3307F	35	80	34.9	49 500	35 000
3308F	40	90	36.5	60 500	44 000
3309F	45	100	39.7	66 500	49 500
3310F	50	110	44.4	85 500	64 500
3311F	55	120	49.2	106 000	82 000
3312F	60	130	54	122 000	95 500
3313F	65	140	58.7	138 000	109 000

High Load Capacity Deep Groove Ball Bearings (Open Type)

- Applications
- Petroleum and chemical industries (API standards, etc.)
 - Pulp and paper industry (ANSI standards, etc.)
 - Semiconductor and liquid crystal panels (vacuum pumps)

High load capacity enables reduced pump size and extended maintenance intervals.



Compared to conventional bearings:

- Bearing life: 70% longer

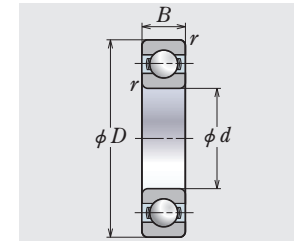

Bearing Designation

Example: **HR 6305 C3**

High load capacity: HR
 Basic designation: 6305
 Internal clearance: C3

Bearing Designation	Boundary Dimensions (mm)				Basic Load Ratings (N)	
	<i>d</i>	<i>D</i>	<i>B</i>	<i>r</i> (min.)	<i>C_r</i> (dynamic)	<i>C_{0r}</i> (static)
HR 6202	15	35	11	0.6	8 550	3 950
HR 6302	15	42	13	1.0	13 300	5 900
HR 6203	17	40	12	0.6	11 300	5 350
HR 6303	17	47	14	1.0	15 600	7 100
HR 6304	20	52	15	1.1	18 200	9 050
HR 6205	25	52	15	1.0	15 300	8 100
HR 6305	25	62	17	1.1	23 700	12 200
HR 6206	30	62	16	1.0	23 300	12 800
HR 6306	30	72	19	1.1	29 800	15 800
HR 6207	35	72	17	1.1	28 300	16 000
HR 6307	35	80	21	1.5	39 500	21 500
HR 6208	40	80	18	1.1	32 500	19 900
HR 6308	40	90	23	1.5	47 000	26 200
HR 6209	45	85	19	1.1	36 500	22 600
HR 6309	45	100	25	1.5	57 000	34 500
HR 6210	50	90	20	1.1	39 000	25 800
HR 6310	50	110	27	2.0	66 500	40 500
HR 6211	55	100	21	1.5	48 000	32 000
HR 6311	55	120	29	2.0	78 000	46 000
HR 6212	60	110	22	1.5	58 000	38 000

■ Features of Bearings for Pumps

Creep-Free Bearings™

Applications • Water/Sewage and Irrigation, etc.

Outer ring creep prevention is significantly improved by O-ring tension in the housing. Standard principal dimensions are maintained to eliminate the need for re-machining housings, thereby reducing costs.

(Recommended fits: G6 or H7)

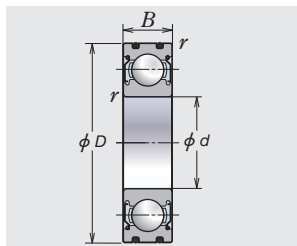
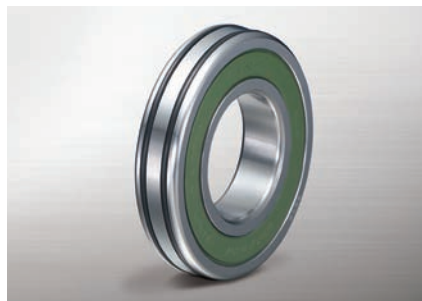

Bearing Designation	Boundary Dimensions (mm)				Basic Load Ratings (N)	
	<i>d</i>	<i>D</i>	<i>B</i>	<i>r</i> (min.)	<i>C_r</i> (dynamic)	<i>C_{0r}</i> (static)
6000	10	26	8	0.3	4 550	1 970
6200	10	30	9	0.6	5 100	2 390
6300	10	35	11	0.6	8 100	3 450
6001	12	28	8	0.3	5 100	2 370
6201	12	32	10	0.6	6 800	3 050
6301	12	37	12	1.0	9 700	4 200
6002	15	32	9	0.3	5 600	2 830
6202	15	35	11	0.6	7 650	3 750
6302	15	42	13	1.0	11 400	5 450
6003	17	35	10	0.3	6 000	3 250
6203	17	40	12	0.6	9 550	4 800
6303	17	47	14	1.0	13 600	6 650
6004	20	42	12	0.6	9 400	5 000
6204	20	47	14	1.0	12 800	6 600
6304	20	52	15	1.1	15 900	7 900
6005	25	47	12	0.6	10 100	5 850
6205	25	52	15	1.0	14 000	7 850
6305	25	62	17	1.1	20 600	11 200
6006	30	55	13	1.0	13 200	8 300
6206	30	62	16	1.0	19 500	11 300
6306	30	72	19	1.1	26 700	15 000
6007	35	62	14	1.0	16 000	10 300
6207	35	72	17	1.1	25 700	15 300
6307	35	80	21	1.5	33 500	19 200
6008	40	68	15	1.0	16 800	11 500
6208	40	80	18	1.1	29 100	17 900
6308	40	90	23	1.5	40 500	24 000
6009	45	75	16	1.0	20 900	15 200
6209	45	85	19	1.1	31 500	20 400
6309	45	100	25	1.5	53 000	32 000

Air Turbine
Dental
Handpieces

Pumps &
Compressors

Agricultural
Machinery

Construction
Machinery

Mining
Machinery

Railway
Rolling Stock

Papermaking
Machines

Wind Power
Industry

Steel Industry

INDUSTRY
SOLUTIONS

Air Turbine
Dental
Handpieces

Pumps &
Compressors

Agricultural
Machinery

Construction
Machinery

Mining
Machinery

Railway
Rolling Stock

Papermaking
Machines

Wind Power
Industry

Steel Industry

INDUSTRY
SOLUTIONS

Bearings for Compressors

L-PPS (Linear-Polyphenylene Sulfide) cages are chemically stable and resist wear better than steel or brass. Optimized internal geometries allow efficient lubricant flow through the bearing.

Compressors for Refrigeration and Air Conditioning

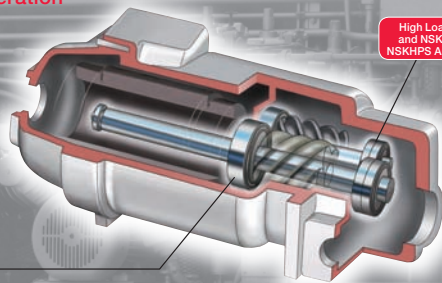

High Load Capacity Cylindrical Roller Bearings and NSKHPS Angular Contact Ball Bearings, or NSKHPS Angular Contact Ball Bearings (Combined)

High Load Capacity Cylindrical Roller Bearings

Oil-Free Screw Compressors

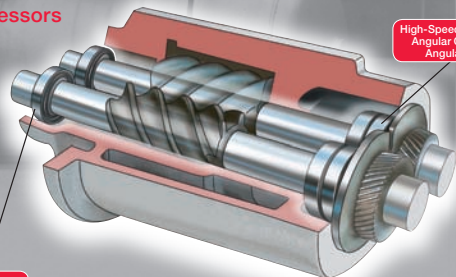

High-Speed Cylindrical Roller Bearings, High-Speed Angular Contact Ball Bearings, and High-Speed Angular Contact Ball Bearings (Combined)

High-Speed Cylindrical Roller Bearings

Scroll Compressors

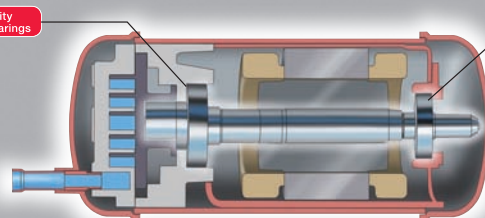

High Load Capacity Cylindrical Roller Bearings

Deep Groove Ball Bearings

Features of Bearings for Compressors



High Load Capacity Cylindrical Roller Bearings (L-PPS Cage)

- High load capacity cylindrical roller bearings with high-performance L-PPS plastic cages.
- Heat-resistant L-PPS plastic cages deliver chemical stability that ensures strength with little to no deterioration, even in compressor oil, refrigeration machine oil, or ammonia refrigerant, while also providing excellent abrasion resistance.

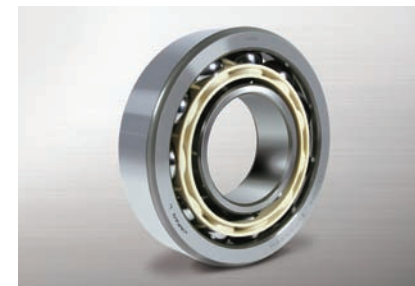

NSKHPS™ Angular Contact Ball Bearings (L-PPS cage)

- High load capacity angular contact ball bearings with high-performance L-PPS plastic cages.
- Improved bearing life (up to 90% longer) over conventional bearings reduces maintenance frequency and improves reliability.

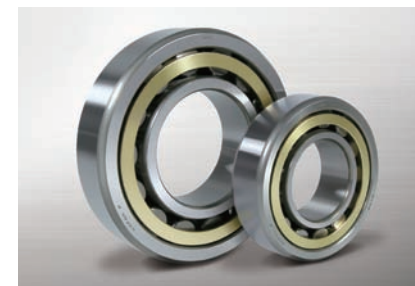

High-Speed Cylindrical Roller Bearings

- High-speed cylindrical roller bearings with outer ring guided machined-brass cages.
- Class P5 tolerances as standard ensure stable performance at high speeds.



High-Speed Angular Contact Ball Bearings

- High-speed angular contact ball bearings with outer ring guided machined-brass cages.
- Class P5 tolerances as standard ensure stable performance at high speeds.

Air Turbine
Dental
Handpieces

Pumps &
Compressors

Agricultural
Machinery

Construction
Machinery

Mining
Machinery

Railway
Rolling Stock

Papermaking
Machines

Wind Power
Industry

Steel Industry

Air Turbine
Dental
Handpieces

Pumps &
Compressors

Agricultural
Machinery

Construction
Machinery

Mining
Machinery

Railway
Rolling Stock

Papermaking
Machines

Wind Power
Industry

Steel Industry

INDUSTRY
SOLUTIONS

■ Features of Bearings for Compressors

High Load Capacity Cylindrical Roller Bearings (L-PPS Cage)

- Applications
- Refrigeration and air conditioning screw compressors
 - Air and gas screw compressors

Outstanding load capacity and lubrication performance allow for reduced compressor size and extended maintenance intervals.



Radial Internal Clearance Unit: μm

Nominal Bore Diameter d (mm)		Interchangeable CN clearance		Non-Interchangeable CC Clearance	
Over	Incl.	Min.	Max.	Min.	Max.
10	24	20	45	20	30
24	30	20	45	25	35
30	40	25	50	25	40
40	50	30	60	30	45
50	65	40	70	35	50
65	80	40	75	40	60
80	100	50	85	45	70

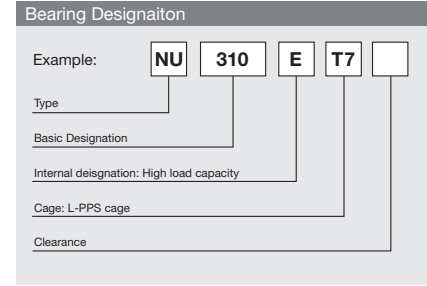
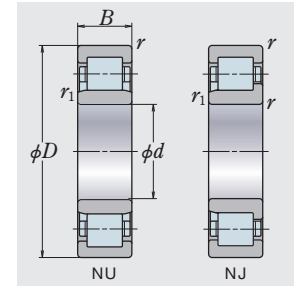

Bearing Designation	Boundary Dimensions (mm)					Basic Load Ratings (N)	
	d	D	B	r (min.)	r_1 (min.)	C_r (dynamic)	C_{0r} (static)
NU (NJ) 204ET7	20	47	14	1	0.6	25 700	22 600
NU (NJ) 304ET7	20	52	15	1.1	0.6	31 500	26 900
NU (NJ) 2204ET7	20	47	18	1	0.6	30 500	28 300
NU (NJ) 2304ET7	20	52	21	1.1	0.6	42 000	39 000
NU (NJ) 205ET7	25	52	15	1	0.6	29 300	27 700
NU (NJ) 305ET7	25	62	17	1.1	1.1	41 500	37 500
NU (NJ) 2205ET7	25	52	18	1	0.6	35 000	34 500
NU (NJ) 2305ET7	25	62	24	1.1	1.1	57 000	56 000
NU (NJ) 206ET7	30	62	16	1	0.6	39 000	37 500
NU (NJ) 306ET7	30	72	19	1.1	1.1	53 000	50 000
NU (NJ) 2206ET7	30	62	20	1	0.6	49 000	50 000
NU (NJ) 2306ET7	30	72	27	1.1	1.1	74 500	77 500
NU (NJ) 207ET7	35	72	17	1.1	0.6	50 500	50 000
NU (NJ) 307ET7	35	80	21	1.5	1.1	66 500	65 500
NU (NJ) 2207ET7	35	72	23	1.1	0.6	61 500	65 000
NU (NJ) 2307ET7	35	80	31	1.5	1.1	93 000	101 000
NU (NJ) 208ET7	40	80	18	1.1	1.1	55 500	55 500
NU (NJ) 308ET7	40	90	23	1.5	1.5	83 000	81 500
NU (NJ) 2208ET7	40	80	23	1.1	1.1	72 500	77 500
NU (NJ) 2308ET7	40	90	33	1.5	1.5	114 000	122 000
NU (NJ) 209ET7	45	85	19	1.1	1.1	63 000	66 500
NU (NJ) 309ET7	45	100	25	1.5	1.5	97 500	98 500
NU (NJ) 2209ET7	45	85	23	1.1	1.1	76 000	84 500
NU (NJ) 2309ET7	45	100	36	1.5	1.5	137 000	153 000
NU (NJ) 210ET7	50	90	20	1.1	1.1	69 000	76 500
NU (NJ) 310ET7	50	110	27	2	2	110 000	113 000
NU (NJ) 2210ET7	50	90	23	1.1	1.1	86 500	97 000
NU (NJ) 2310ET7	50	110	40	2	2	163 000	187 000
NU (NJ) 211ET7	55	100	21	1.5	1.1	86 500	98 500
NU (NJ) 311ET7	55	120	29	2	2	137 000	143 000
NU (NJ) 2211ET7	55	100	25	1.5	1.1	101 000	122 000

Bearing Designation	Boundary Dimensions (mm)					Basic Load Ratings (N)	
	d	D	B	r (min.)	r_1 (min.)	C_r (dynamic)	C_{0r} (static)
NU (NJ) 2311ET7	55	120	43	2	2	201 000	233 000
NU (NJ) 212ET7	60	110	22	1.5	1.5	97 500	107 000
NU (NJ) 312ET7	60	130	31	2.1	2.1	150 000	157 000
NU (NJ) 2212ET7	60	110	28	1.5	1.5	131 000	157 000
NU (NJ) 2312ET7	60	130	46	2.1	2.1	222 000	262 000
NU (NJ) 213ET7	65	120	23	1.5	1.5	108 000	119 000
NU (NJ) 313ET7	65	140	33	2.1	2.1	181 000	191 000
NU (NJ) 2213ET7	65	120	31	1.5	1.5	149 000	181 000
NU (NJ) 2313ET7	65	140	48	2.1	2.1	233 000	265 000
NU (NJ) 214ET7	70	125	24	1.5	1.5	119 000	137 000
NU (NJ) 314ET7	70	150	35	2.1	2.1	205 000	222 000
NU (NJ) 2214ET7	70	125	31	1.5	1.5	156 000	194 000
NU (NJ) 2314ET7	70	150	51	2.1	2.1	274 000	325 000
NU (NJ) 215ET7	75	130	25	1.5	1.5	130 000	156 000
NU (NJ) 315ET7	75	160	37	2.1	2.1	240 000	263 000
NU (NJ) 2215ET7	75	130	31	1.5	1.5	162 000	207 000
NU (NJ) 2315ET7	75	160	55	2.1	2.1	330 000	395 000
NU (NJ) 216ET7	80	140	26	2	2	139 000	167 000
NU (NJ) 316ET7	80	170	39	2.1	2.1	256 000	282 000
NU (NJ) 2216ET7	80	140	33	2	2	186 000	243 000
NU (NJ) 2316ET7	80	170	58	2.1	2.1	355 000	430 000
NU (NJ) 217ET7	85	150	28	2	2	167 000	199 000
NU (NJ) 2217ET7	85	150	36	2	2	217 000	279 000
NU (NJ) 2317ET7	85	180	60	3	3	395 000	485 000
NU (NJ) 218ET7	90	160	30	2	2	182 000	217 000
NU (NJ) 2218ET7	90	160	40	2	2	242 000	315 000
NU (NJ) 2318ET7	90	190	64	3	3	435 000	535 000
NU (NJ) 220ET7	100	180	34	2.1	2.1	310 000	305 000
NU (NJ) 320ET7	100	215	47	3	3	380 000	425 000
NU (NJ) 2220ET7	100	180	46	2.1	2.1	335 000	445 000
NU (NJ) 2320ET7	100	215	73	3	3	570 000	715 000

Air Turbine Dental Handpieces
Pumps & Compressors
Agricultural Machinery
Construction Machinery
Mining Machinery
Railway Rolling Stock
Papermaking Machines
Wind Power Industry
Steel Industry

Air Turbine Dental Handpieces
Pumps & Compressors
Agricultural Machinery
Construction Machinery
Mining Machinery
Railway Rolling Stock
Papermaking Machines
Wind Power Industry
Steel Industry

■ Features of Bearings for Compressors

NSKHPS™ Angular Contact Ball Bearings (L-PPS Cage)

- Applications**
- Refrigeration and air conditioning screw compressors
 - Air and gas screw compressors

Outstanding load capacity and lubrication performance allow for reduced compressor size and extended maintenance intervals.

Compared to conventional bearings:

- Bearing life: up to 90% longer
- Maximum rotational speed: up to 20% faster
- Universal arrangement as standard
- 40° contact angle

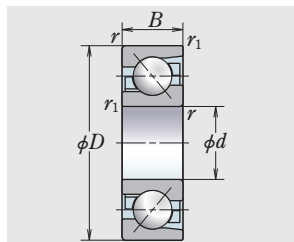
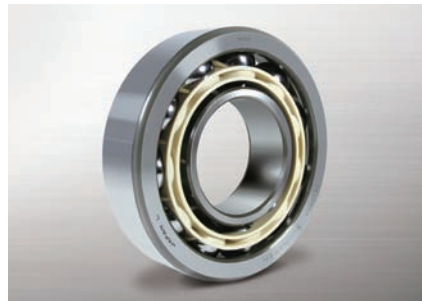

Bearing Designation

Example: **7310 B EA T7 SU CNB**

Basic Designation: 7310
 Contact angle: 40°
 Internal designation: High load capacity
 Cage: L-PPS cage
 Arrangement: Universal arrangement (single unit)
 Internal clearance

Axial Internal Clearance Unit: μm

Nominal Bore Diameter d (mm)		CNB		GA	
Over	Incl.	Min.	Max.	Min.	Max.
12	18	17	25		
18	30	20	28	-2	6
30	50	24	32		
50	80	29	41	-3	9

Bearing Designation	Boundary Dimensions (mm)					Basic Load Ratings (N)		Maximum Rotational Speed (min ⁻¹) Oil
	d	D	B	r (min.)	r ₁ (min.)	C _r (dynamic)	C _{0r} (static)	
7201BEA	12	32	10	0.6	0.3	8 150	3 750	30 000
7301BEA	12	37	12	1	0.6	11 100	4 950	26 000
7202BEA	15	35	11	0.6	0.3	9 800	4 800	26 000
7302BEA	15	42	13	1	0.6	14 300	6 900	22 000
7203BEA	17	40	12	0.6	0.3	11 600	6 100	22 000
7303BEA	17	47	14	1	0.6	16 800	8 300	20 000
7204BEA	20	47	14	1	0.6	15 600	8 150	19 000
7304BEA	20	52	15	1.1	0.6	19 800	10 500	18 000
7205BEA	25	52	15	1	0.6	17 600	10 200	17 000
7305BEA	25	62	17	1.1	0.6	27 200	14 900	15 000
7206BEA	30	62	16	1	0.6	23 700	14 300	14 000
7306BEA	30	72	19	1.1	0.6	36 500	20 600	13 000
7207BEA	35	72	17	1.1	0.6	32 500	19 600	12 000
7307BEA	35	80	21	1.5	1	40 500	24 400	11 000
7208BEA	40	80	18	1.1	0.6	38 500	24 500	11 000
7308BEA	40	90	23	1.5	1	53 000	33 000	10 000
7209BEA	45	85	19	1.1	0.6	40 500	27 100	10 000
7309BEA	45	100	25	1.5	1	62 500	39 500	9 000
7210BEA	50	90	20	1.1	0.6	42 000	29 700	9 500
7310BEA	50	110	27	2	1	78 000	50 500	8 000
7211BEA	55	100	21	1.5	1	51 500	37 000	8 500
7311BEA	55	120	29	2	1	89 000	58 500	7 500
7212BEA	60	110	22	1.5	1	61 500	45 000	7 500
7312BEA	60	130	31	2.1	1.1	102 000	68 500	6 700
7213BEA	65	120	23	1.5	1	70 000	53 500	7 100
7313BEA	65	140	33	2.1	1.1	114 000	77 000	6 300
7214BEA	70	125	24	1.5	1	75 500	58 500	6 700
7314BEA	70	150	35	2.1	1.1	124 000	87 500	6 000
7215BEA	75	130	25	1.5	1	78 500	63 500	6 300
7216BEA	80	140	26	2	1	87 500	70 000	6 000

High-Speed Cylindrical Roller Bearings

- Applications**
- Air (oil-free) screw compressors

High-speed cylindrical roller bearings, adopting outer ring guided machined-brass cages. **d_mn: 1 300 000** (see Remarks 1 & 2) and bearing accuracy greater than Class P5 as standard.

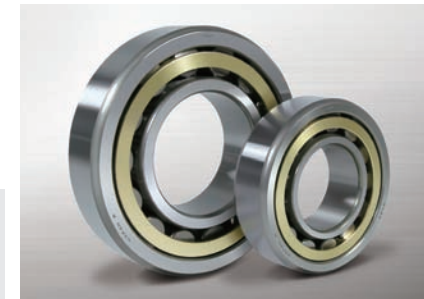
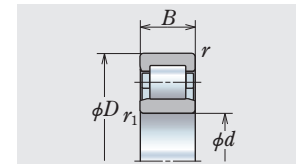

Bearing Designation	Boundary Dimensions (mm)					Basic Load Ratings (N)	
	d	D	B	r (min.)	r ₁ (min.)	C _r (dynamic)	C _{0r} (static)
NU205EMM	25	52	15	1	0.6	29 300	27 700
NU206EMM	30	62	16	1	0.6	39 000	37 500
NU207EMM	35	72	17	1.1	0.6	50 500	50 000
NU208EMM	40	80	18	1.1	1.1	55 500	55 500
NU209EMM	45	85	19	1.1	1.1	63 000	66 500
NU210EMM	50	90	20	1.1	1.1	69 000	76 500

- Remarks** 1: Under general forced-lubrication conditions
 2: Consult NSK regarding maximum rotational speed, which can vary according to service conditions and lubrication.

High-Speed Angular Contact Ball Bearings

- Applications**
- Air (oil-free) screw compressors

High-speed angular contact bearings with outer ring guided machined-brass cages. **d_mn: 1 300 000** (see Remarks 1 & 2) and bearing accuracy greater than Class P5 as standard.

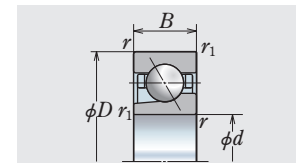

Bearing Designation	Boundary Dimensions (mm)					Basic Load Ratings (N)	
	d	D	B	r (min.)	r ₁ (min.)	C _r (dynamic)	C _{0r} (static)
20BA02A	20	47	14	1	0.6	13 600	7 550
25BA02A	25	52	15	1	0.6	15 400	9 500
30BA03B	30	72	19	1.5	0.6	31 500	19 000
35BA03B	35	80	21	1.5	0.6	39 000	24 000
40BA02A	40	80	18	1.5	0.6	34 500	24 100
45BA03A2	45	100	25	1.5	1	60 000	40 000
50BA03A1	50	110	27	1	2.5	70 000	47 500

- Remarks** 1: Under general forced-lubrication conditions
 2: Consult NSK regarding maximum rotational speed, which can vary according to service conditions and lubrication.

Air Turbine Dental Handpieces
 Pumps & Compressors
 Agricultural Machinery
 Construction Machinery
 Mining Machinery
 Railway Rolling Stock
 Papermaking Machines
 Wind Power Industry
 Steel Industry
 Air Turbine Dental Handpieces
 Pumps & Compressors
 Agricultural Machinery
 Construction Machinery
 Mining Machinery
 Railway Rolling Stock
 Papermaking Machines
 Wind Power Industry
 Steel Industry
 INDUSTRY SOLUTIONS

Bearings for Agricultural Machinery

High-performance bearings that provide high reliability and efficiency for agricultural equipment and machinery.

Bearing Tables

TM Series Sealed Deep Groove Ball Bearings D 032



Air Turbine
Dental
Handpieces

Pumps &
Compressors

**Agricultural
Machinery**

Construction
Machinery

Mining
Machinery

Railway
Rolling Stock

Papermaking
Machines

Wind Power
Industry

Steel Industry

INDUSTRY
SOLUTIONS

Air Turbine
Dental
Handpieces

Pumps &
Compressors

**Agricultural
Machinery**

Construction
Machinery

Mining
Machinery

Railway
Rolling Stock

Papermaking
Machines

Wind Power
Industry

Steel Industry

INDUSTRY
SOLUTIONS

Bearings for Agricultural Machinery

Lineup



Powertrain

Engine/Electrical Accessories



Plastic Pulley for Accessory & Timing Belts



Water Pump Bearings

Other



Ball Bearing Units

Implements



Agri Disc Hub

Drivetrain

Transmission/Differential Gear/Propeller Shaft



Needle Roller Bearings



Creep-Free Bearings™



HR Series Tapered Roller Bearings



NSKHPS™ Deep Groove Ball Bearings



Double-Row Angular Contact Ball Bearings



Thrust Ball Bearings



Long-Life Pinion Shaft With Cage and Rollers



TM Series Sealed Deep Groove Ball Bearings



Deep Groove Ball Bearings



UR Bearings (Special Carbonitriding Heat-Treatment Technology)



NSKHPS™ Spherical Roller Bearings



Hub Unit Bearings (HUB I)

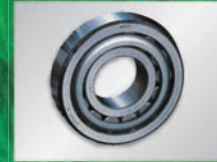

Hi-TF Bearings

Chassis

Wheel/Steering

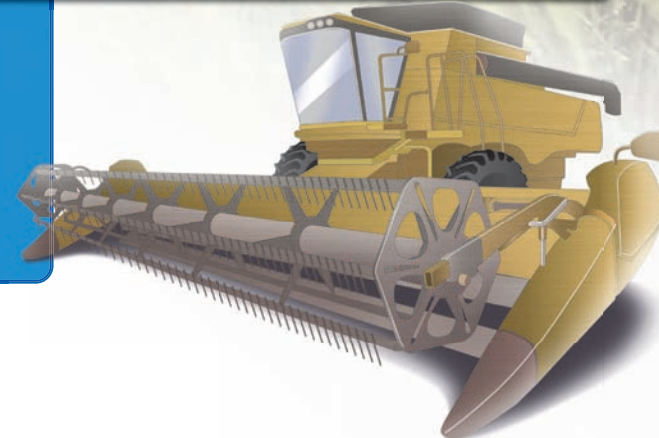

Air Turbine Dental Handpieces

Pumps & Compressors

Agricultural Machinery

Construction Machinery

Mining Machinery

Railway Rolling Stock

Papermaking Machines

Wind Power Industry

Steel Industry

INDUSTRY SOLUTIONS

Air Turbine Dental Handpieces

Pumps & Compressors

Agricultural Machinery

Construction Machinery

Mining Machinery

Railway Rolling Stock

Papermaking Machines

Wind Power Industry

Steel Industry

INDUSTRY SOLUTIONS

■ Bearings for Agricultural Machinery

High-Performance Standard NSKHPS™ Series Deep Groove Ball Bearings/ Cylindrical Roller Bearings/Spherical Roller Bearings for Industrial Machinery



The NSKHPS™ Series redefines the concept of standard bearings.

- Improved reliability
Thanks to optimization of the bearing's internal design and improvement of processing technology, NSKHPS bearings feature up to 15% longer bearing life over conventional bearings. As a result, NSKHPS bearings reduce maintenance costs and facilitate the downscaling of related equipment.
- New product lineup
Standard dimensions are the same as those for standard-size bearings. NSK has expanded the lineup of NSKHPS bearings to focus on a wide range of sizes with a high degree of versatility for generalpurpose applications. Please refer to Pages C020–C035 for the dimensions of NSKHPS deep groove ball bearings and Page D038 for more detailed information on NSKHPS cylindrical roller and spherical roller bearings.

Features

Compared with conventional bearings ...

Bearing Life
15% higher

New Product Line-up
Wide range line-up

HR Series High-Load Bearings (Tapered Roller Bearings/Deep Groove Ball Bearings)

HR Series high-load bearings provide excellent performance in diverse applications.

Features

- Higher load-carrying capacity and longer operating life.
- Tapered roller bearings
An optimized cage design allows for larger rollers and higher roller count.
- Deep groove ball bearings
Standard dimensions are identical to standard-size bearings and feature designs with optimized ball diameters and quantity.



UR Bearings

A special carbonitriding heat treatment (UR) through hardens bearing steel and enables long life.

Features

- More than double the bearing life of standard bearings under harsh or contaminated lubrication conditions.
- Optional combinations with high-capacity Series enable further extended life.
- A wide range of products can receive the UR treatment since the treatment can be performed on regular bearing steel.

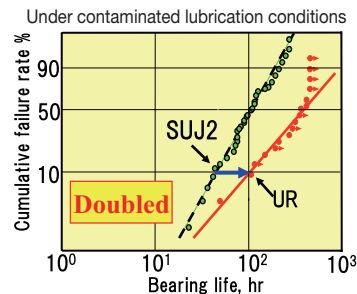

TM Series Sealed Deep Groove Ball Bearings

The TM Series delivers longer operating life in contaminated environments by incorporating a special seal that prevents the entry of foreign particles and is especially effective in agricultural machinery and automobile transmission systems.

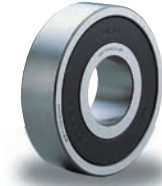

Features

- Seal lip structure prevents entry of foreign matter while allowing entry of oil.
- Lower torque than conventional contact seal bearings.
- Sealed-in grease with a high affinity for gear oil aids initial lubrication.

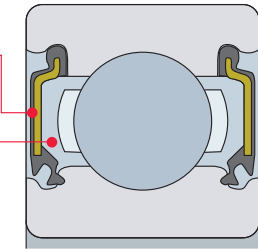

Bearing Series

TM302-TM314 / TM203-TM214

Major dimensions are the same as the Series 62 and Series 63 deep groove ball bearings.

Long-Life Pinion Shaft With Cage and Rollers

These bearings have improved durability and reliability to achieve long service life under harsh operating conditions, such as prolonged continuous operation, by utilizing a pinion shaft with a cage and rollers as a single assembly.

Features

- Special heat treatment and improved raceway surfaces more than double service life.
- Pinion shaft
- Raceway polished to a mirror-smooth finish to ensure a sufficiently thick oil film.
 - Special heat treatment applied to pinion shaft as a measure against contaminated-lubricant conditions.
- Cage and rollers
- Roller running surface polished to a mirror-smooth finish to ensure a sufficiently thick oil film.
 - Special heat treatment applied to rollers as a measure against contaminated-lubricant conditions.

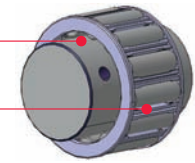
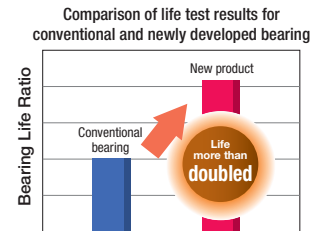

Corresponding size:
Inscribed circle diameter up to 32 mm

HST Long-Life, High-Reliability Cage-Equipped Thrust Ball Bearings for Agricultural Machinery

These bearings contribute to the long life and reliability of agricultural machinery.

Features

Over twice the life of conventional bearings through the use of special technology.

- Long-life technology
EP steel, which is strong against subsurface fatigue, is used for the inner and outer ring. A special heat treatment is applied to the rings and balls to resist surface fatigue.
- High-reliability cage
A plastic cage resistant to cage load is used to improve reliability.

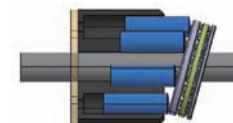

Air Turbine Dental Handpieces
 Pumps & Compressors
 Agricultural Machinery
 Construction Machinery
 Mining Machinery
 Railway Rolling Stock
 Papermaking Machines
 Wind Power Industry
 Steel Industry
 Pumps & Compressors
 Agricultural Machinery
 Construction Machinery
 Mining Machinery
 Railway Rolling Stock
 Papermaking Machines
 Wind Power Industry
 Steel Industry
 INDUSTRIAL SOLUTIONS

TM Series Sealed Deep Groove Ball Bearings

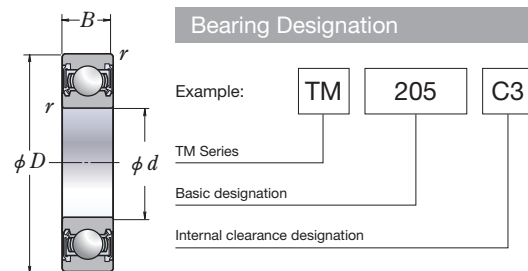
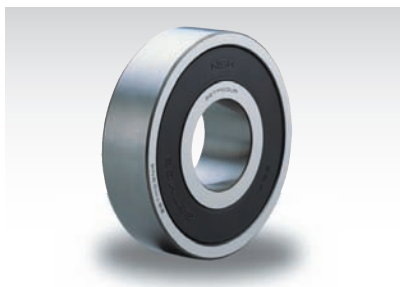

Bearing Designation	Boundary Dimensions (mm)			Basic Load Ratings (N)	
	<i>d</i>	<i>D</i>	<i>B</i>	<i>C_r</i>	<i>C_{0r}</i>
TM203	17	40	12	9 550	4 800
TM303	17	47	14	13 600	6 650
TM204	20	47	14	12 800	6 600
TM304	20	52	15	15 900	7 900
TM2/22	22	50	14	12 900	6 800
TM3/22	22	56	16	18 400	9 250
TM205	25	52	15	14 000	7 850
TM305	25	62	17	20 600	11 200
TM2/28	28	58	16	16 600	9 500
TM3/28	28	68	18	26 700	14 000
TM206	30	62	16	19 500	11 300
TM306	30	72	19	26 700	15 000
TM2/32	32	65	17	20 700	11 600
TM3/32	32	75	20	29 400	17 000
TM207	35	72	17	25 700	15 300
TM307	35	80	21	33 500	19 200
TM208	40	80	18	29 100	17 800
TM308	40	90	23	40 500	24 000
TM209	45	85	19	31 500	20 400
TM309	45	100	25	53 000	32 000
TM210	50	90	20	35 000	23 200
TM310	50	110	27	62 000	38 500
TM211	55	100	21	43 500	29 300
TM311	55	120	29	71 500	44 500
TM212	60	110	22	52 500	36 000
TM312	60	130	31	82 000	52 000
TM213	65	120	23	57 500	40 000
TM313	65	140	33	92 500	60 000
TM214	70	125	24	62 000	44 000
TM314	70	150	35	104 000	68 000

Note The maximum continuous operating temperature for standard nitrile rubber seals is 110 °C.

Air Turbine
Dental
Handpieces

Pumps &
Compressors

Agricultural
Machinery

Construction
Machinery

Mining
Machinery

Railway
Rolling Stock

Papermaking
Machines

Wind Power
Industry

Steel Industry

INDUSTRY
SOLUTIONS

Air Turbine
Dental
Handpieces

Pumps &
Compressors

Agricultural
Machinery

Construction
Machinery

Mining
Machinery

Railway
Rolling Stock

Papermaking
Machines

Wind Power
Industry

Steel Industry

INDUSTRY
SOLUTIONS

Bearings for Construction Machinery

Tough bearings that provide long service life under harsh conditions reflect NSK's accumulated technological prowess.

Lineup D 036

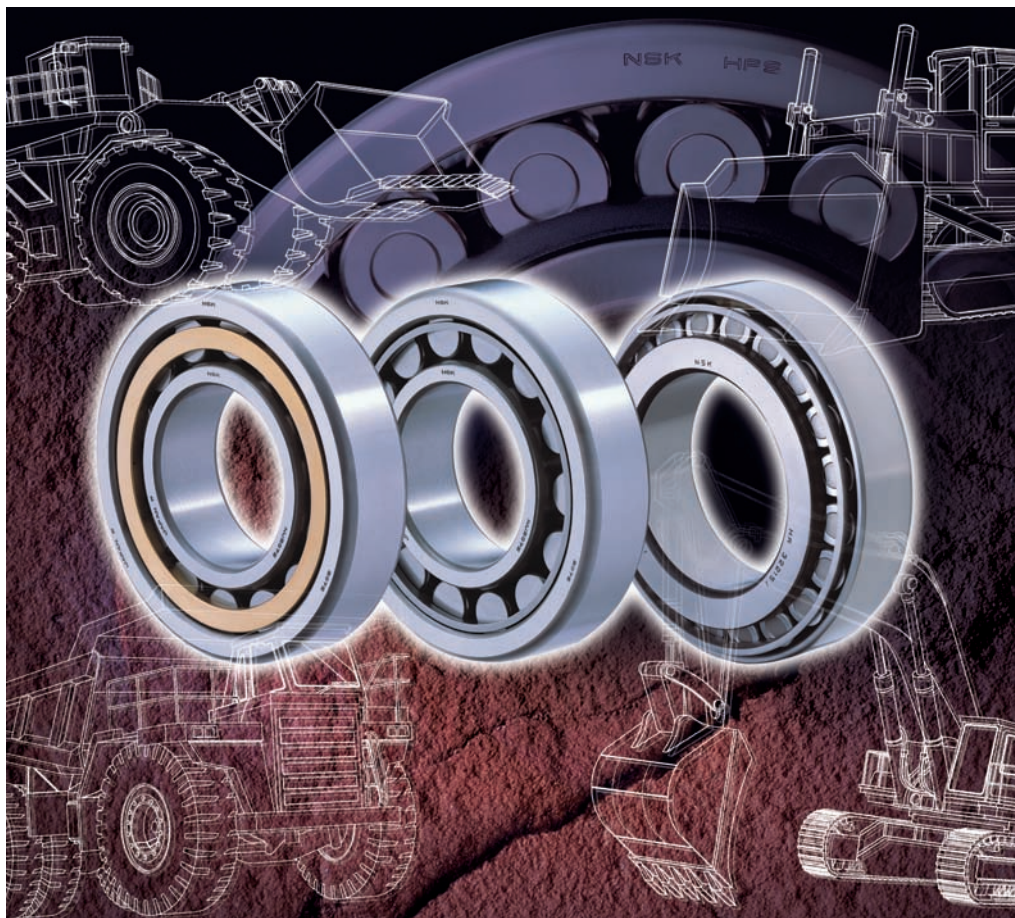

Air Turbine
Dental
Handpieces

Pumps &
Compressors

Agricultural
Machinery

**Construction
Machinery**

Mining
Machinery

Railway
Rolling Stock

Papermaking
Machines

Wind Power
Industry

Steel Industry

INDUSTRY
SOLUTIONS

Air Turbine
Dental
Handpieces

Pumps &
Compressors

Agricultural
Machinery

**Construction
Machinery**

Mining
Machinery

Railway
Rolling Stock

Papermaking
Machines

Wind Power
Industry

Steel Industry

INDUSTRY
SOLUTIONS

Bearings for Construction Machinery

Lineup

- Bearings typically used:
- Tapered Roller Bearings
 - Deep Groove Ball Bearings
 - Needle Roller Bearings

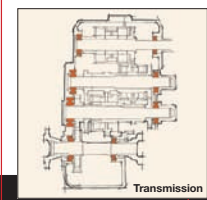
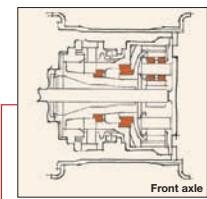
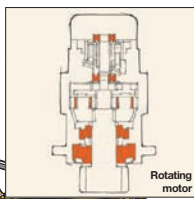
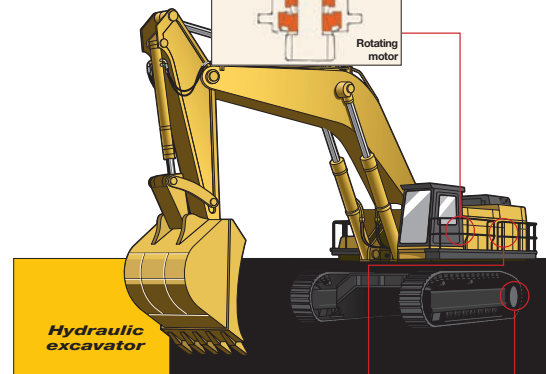

- Bearings typically used:
- Tapered Roller Bearings

- Bearings typically used:
- Cylindrical Roller Bearings
 - Tapered Roller Bearings
 - Deep Groove Ball Bearings

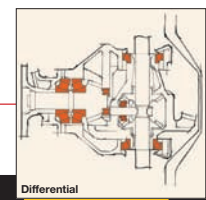
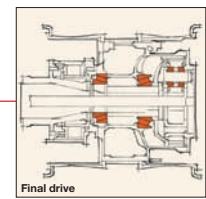
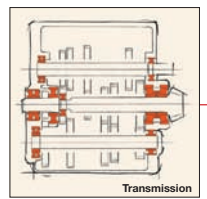
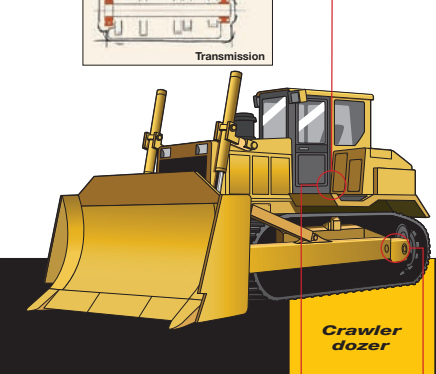

- Bearings typically used:
- Cylindrical Roller Bearings
 - Tapered Roller Bearings
 - Spherical Roller Bearings

- Bearings typically used:
- Tapered Roller Bearings

- Bearings typically used:
- Cylindrical Roller Bearings
 - Tapered Roller Bearings

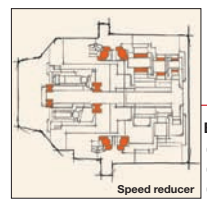
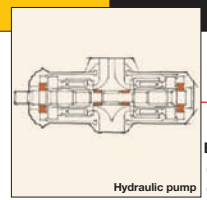
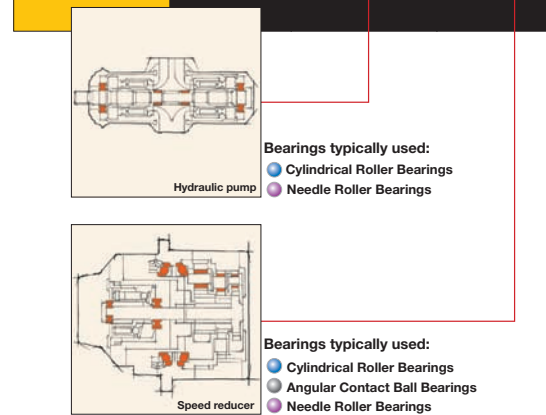

- Bearings typically used:
- Cylindrical Roller Bearings
 - Needle Roller Bearings

- Bearings typically used:
- Cylindrical Roller Bearings
 - Angular Contact Ball Bearings
 - Needle Roller Bearings

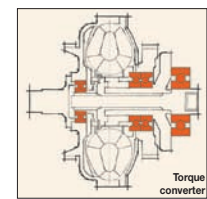
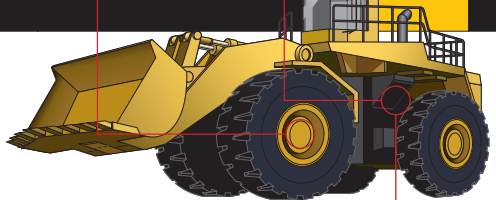

- Bearings typically used:
- Deep Groove Ball Bearings
 - Angular Contact Ball Bearings

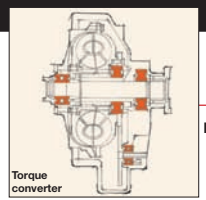
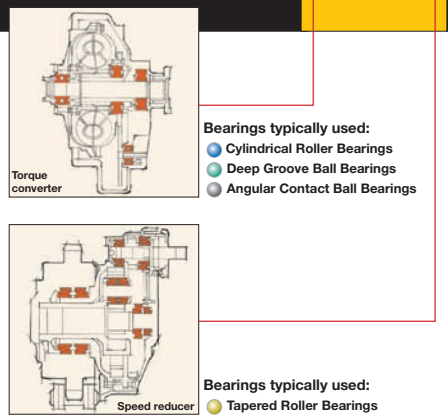

- Bearings typically used:
- Cylindrical Roller Bearings
 - Deep Groove Ball Bearings
 - Angular Contact Ball Bearings

- Bearings typically used:
- Tapered Roller Bearings

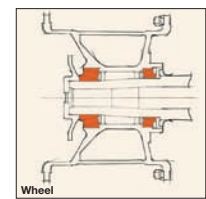
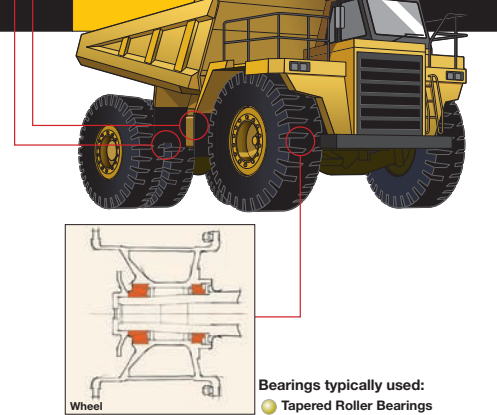

- Bearings typically used:
- Tapered Roller Bearings



NSKHPS™ Spherical Roller Bearings



NSKHPS™ Cylindrical Roller Bearings



HR Series Tapered Roller Bearings



Hi-TF Bearings

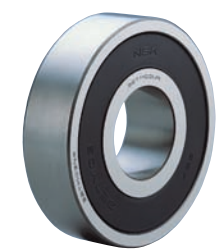

TM Series Sealed Deep Groove Ball Bearings



Long-Life Pinion Shafts with Cage and Rollers

Air Turbine Dental Handpieces
Pumps & Compressors
Agricultural Machinery
Construction Machinery
Mining Machinery
Railway Rolling Stock
Papermaking Machines
Wind Power Industry
Steel Industry

Air Turbine Dental Handpieces
Pumps & Compressors
Agricultural Machinery
Construction Machinery
Mining Machinery
Railway Rolling Stock
Papermaking Machines
Wind Power Industry
Steel Industry

■ Bearings for Construction Machinery

NSKHPS™ Spherical Roller Bearings

Features Compared to the conventional bearing :

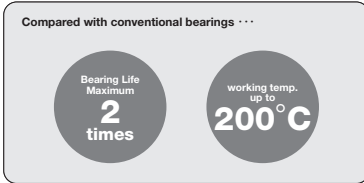

1. Improved reliability
Bearing life is up to twice that of conventional bearings thanks to optimization of the bearing's internal design and improvement of processing technology.

2. High-temperature dimensional stabilizing treatment as standard
NSK's proprietary heat treatment technology enables high temperature dimensional stabilization up to 200 °C.

NSKHPS™ Cylindrical Roller Bearings

Features Compared to the conventional bearing :

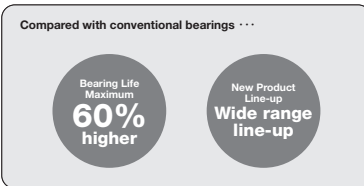

1. Improved reliability
Bearing life is up to 60% longer compared to conventional bearings thanks to an optimized internal design and improvement of processing technology.

2. Wide product lineup
NSK offers a wide lineup of NSKHPS bearings with four types of cages and a range of sizes for a high degree of versatility across general-purpose applications.

- Pressed-steel cage with high cost performance
- Highly reliable machined-brass cage
- Polyamide-resin cage with excellent heat resistance and chemical resistance.

TM Series Sealed Deep Groove Ball Bearings

The TM Series delivers longer operating life under contaminated environments by incorporating a special seal that prevents the entry of foreign particles and is especially effective in agricultural machinery and automobile transmission systems.

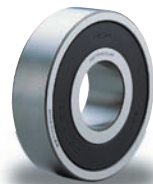

Features

- Seal lip structure prevents entry of foreign matter while allowing entry of oil.
- Lower torque than conventional contact seal bearings.
- Sealed-in grease with a high affinity for gear oil aids initial lubrication.

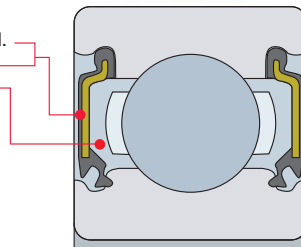

HR Series Tapered Roller Bearings

HR Series high-load capacity, standard-sized tapered roller bearings offer boosted performance in diverse applications.

Features

- Optimized cage design allows increased size and number of rollers
- Higher load-carrying capacity and longer operating life



Long-Life Pinion Shafts With Cage and Rollers

These bearings have improved durability and reliability to achieve long service life under harsh operating conditions, such as extended continuous operation, by utilizing a pinion shaft with a cage and rollers as a single assembly.

Features

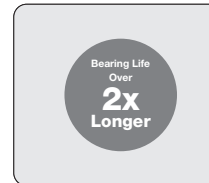

- Pinion shaft
- The raceway is polished to a mirror-smooth finish to ensure a sufficiently thick oil film.
 - A special heat treatment is applied to the pinion shaft as a measure against contaminated-lubricant conditions.
- Cage and rollers
- The roller surface is polished to a mirror-smooth finish to ensure a sufficiently thick oil film.
 - A special heat treatment is applied to the rollers as a measure against contaminated-lubricant conditions.



Corresponding size: Inscribed circle diameter up to 32 mm

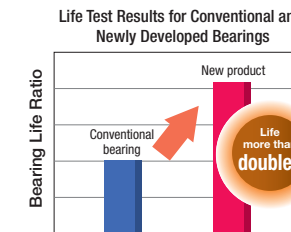

Hi-TF Bearings

Bearings manufactured with NSK's Hi-TF material have been specifically designed for outstanding toughness under harsh operating conditions, surpassing even NSK's earlier TF bearings. Hi-TF bearings incorporate this new material and a new heat-treatment technology to provide long service life under contaminated lubrication conditions with superior resistance to wear, seizure, and heat. Hi-TF bearings meet the rigorous requirements of bearings now and into the future.

Features

- Longer bearing life even under harsh conditions with excellent resistance to wear, seizure, and heat

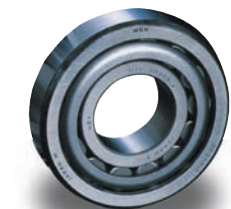

Bearing Series	TM302-TM314 / TM203-TM214	Major dimensions are identical to Series 62 and Series 63 deep groove ball bearings.
-----------------------	---------------------------	--

- Air Turbine Dental Handpieces
- Pumps & Compressors
- Agricultural Machinery
- Construction Machinery
- Mining Machinery
- Railway Rolling Stock
- Papermaking Machines
- Wind Power Industry
- Steel Industry

- Air Turbine Dental Handpieces
- Pumps & Compressors
- Agricultural Machinery
- Construction Machinery
- Mining Machinery
- Railway Rolling Stock
- Papermaking Machines
- Wind Power Industry
- Steel Industry

Bearings for Mining Machinery

Tough bearings that offer longer service life under demanding mining conditions thanks to NSK's wealth of outstanding technologies.

Bearing Tables

CA-VS3 and CA-VS4 Series Super Long-Life Spherical Roller Bearings for Vibrating Equipment D 046

EMM-VS Series Cylindrical Roller Bearings for Vibrating Equipment D 047

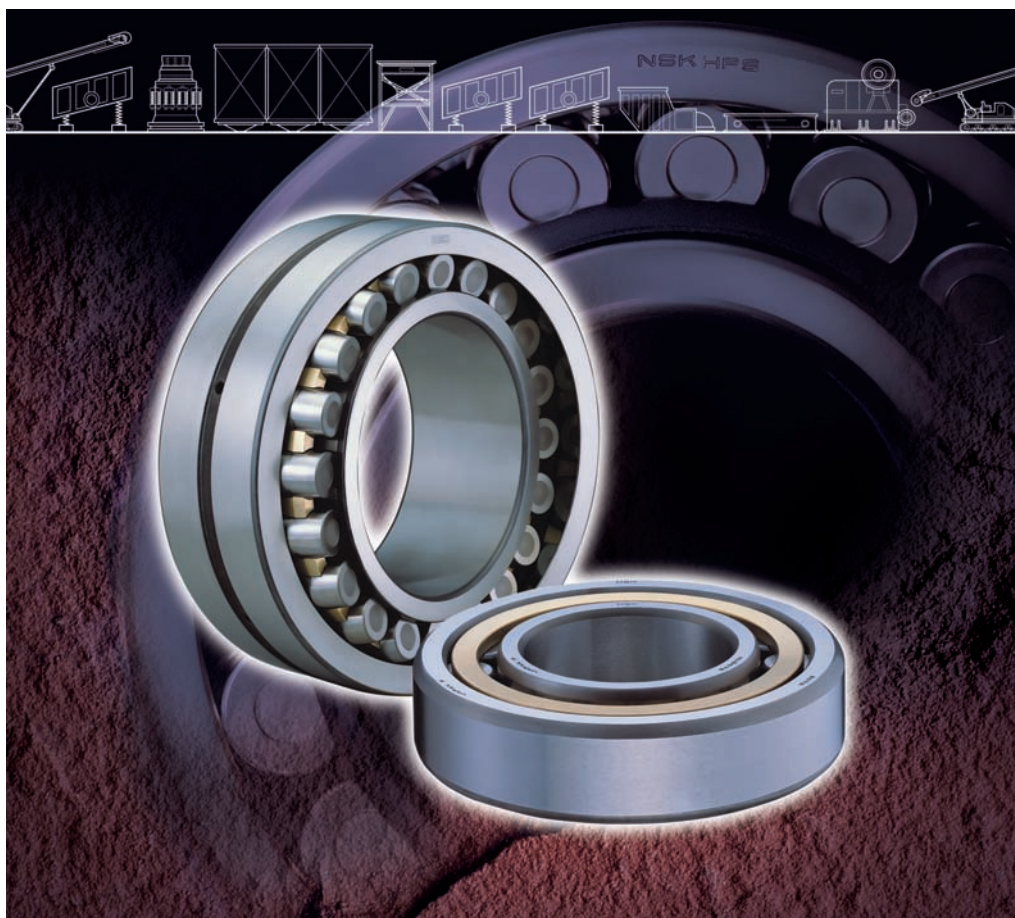

Air Turbine
Dental
Handpieces

Pumps &
Compressors

Agricultural
Machinery

Construction
Machinery

**Mining
Machinery**

Railway
Rolling Stock

Papermaking
Machines

Wind Power
Industry

Steel Industry

Air Turbine
Dental
Handpieces

Pumps &
Compressors

Agricultural
Machinery

Construction
Machinery

**Mining
Machinery**

Railway
Rolling Stock

Papermaking
Machines

Wind Power
Industry

Steel Industry

**INDUSTRY
SOLUTIONS**

Bearings for Mining Machinery

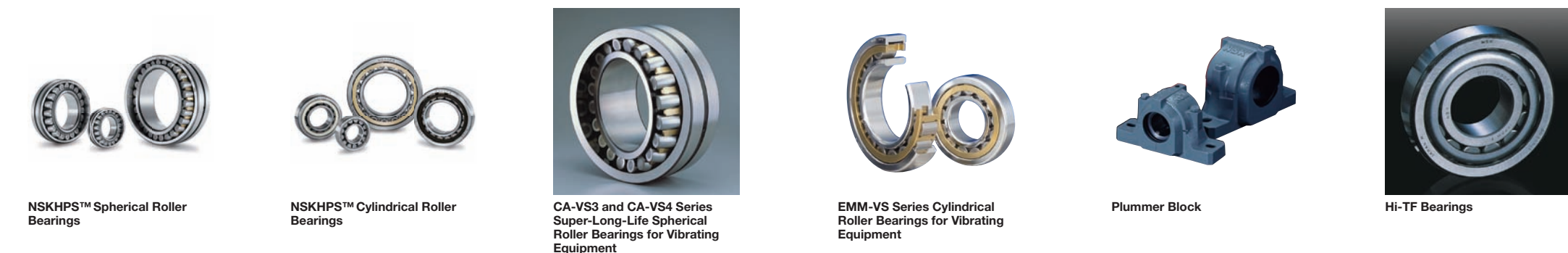
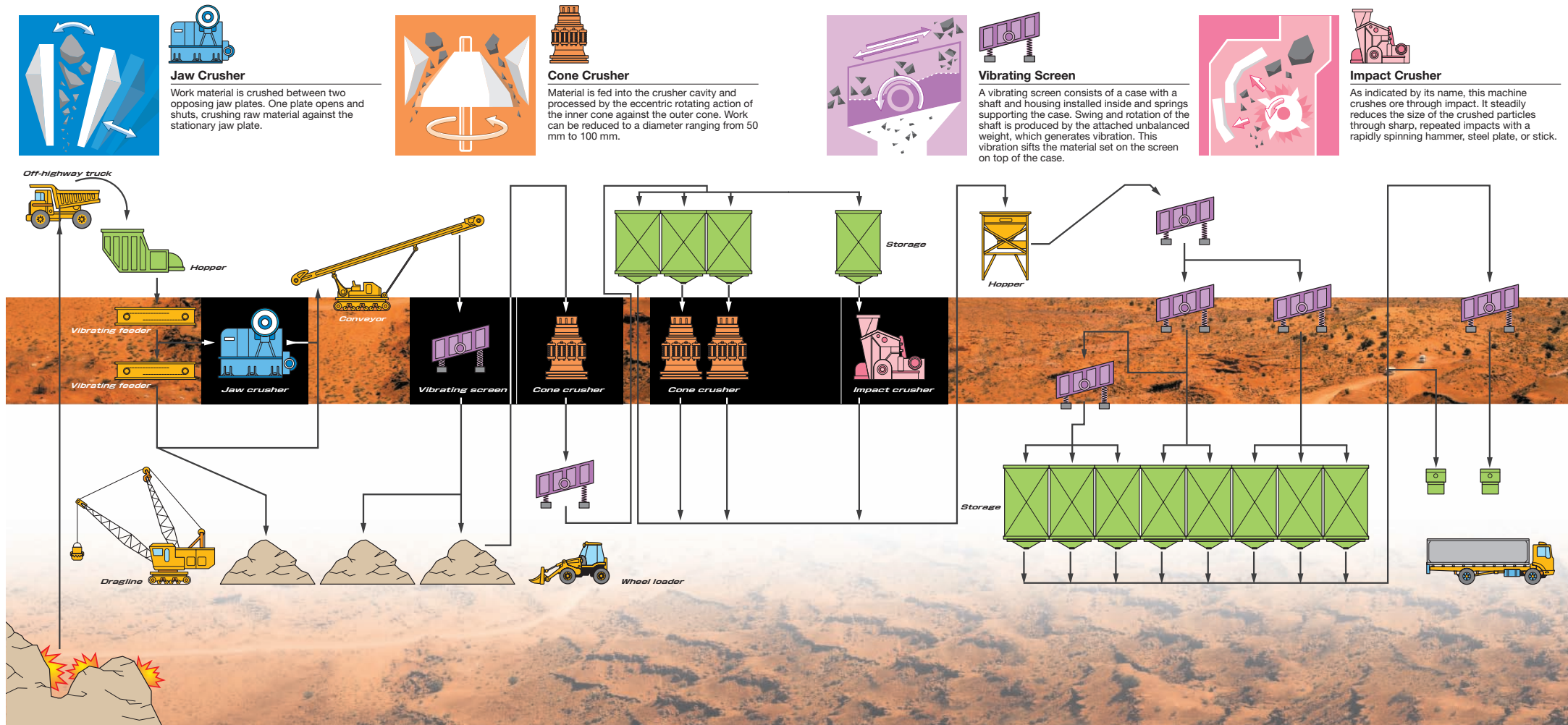

NSKHPS™ Spherical Roller Bearings

NSKHPS™ Cylindrical Roller Bearings

CA-VS3 and CA-VS4 Series Super-Long-Life Spherical Roller Bearings for Vibrating Equipment

EMM-VS Series Cylindrical Roller Bearings for Vibrating Equipment

Plummer Block

Hi-TF Bearings

Air Turbine Dental Handpieces
 Pumps & Compressors
 Agricultural Machinery
 Construction Machinery
Mining Machinery
 Railway Rolling Stock
 Papermaking Machines
 Wind Power Industry
 Steel Industry
INDUSTRY SOLUTIONS

Air Turbine Dental Handpieces
 Pumps & Compressors
 Agricultural Machinery
 Construction Machinery
Mining Machinery
 Railway Rolling Stock
 Papermaking Machines
 Wind Power Industry
 Steel Industry
INDUSTRY SOLUTIONS

■ Bearings for Mining Machinery

NSKHPS™ Spherical Roller Bearings

Features Compared to conventional bearings:

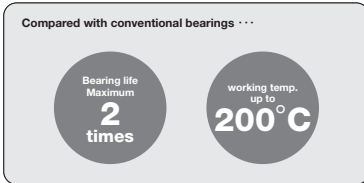

1. Improved reliability
Bearing life has increased by a maximum of 2 times compared with that of conventional bearings by the optimization of the bearing's internal design and improvement of processing technology.

2. High-temperature dimensional stabilizing treatment as standard
NSK's proprietary heat treatment technology enables high-temperature dimensional stabilization up to 200 °C.

NSKHPS™ Cylindrical Roller Bearings

Features Compared to conventional bearings:

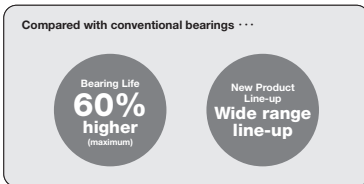

1. Improved reliability
Bearing life is up to 60% longer compared to conventional bearings thanks to optimization of the bearing's internal design and improvement of processing technology.

2. Wide product lineup
NSK offers NSKHPS bearings with four types of cages featuring a range of sizes for a high degree of versatility across general-purpose applications:

- Pressed-steel cage with high cost-performance
- Highly reliable machined-brass cage
- Polyamide-resin cage with excellent heat and chemical resistance

Full Complement Cylindrical Roller Bearings for Crane Sheaves

These cylindrical roller bearings incorporate seals to prevent the entry of foreign matter.

Features

- Improved seals: Contact seals increase resistance to entry of foreign matter or water.
- High load capacity: Larger radial load and axial load capacity compared to conventional sheave bearings.
- Corrosion resistance: Phosphate surface treatment improves resistance to rust.
- Easier grease replenishment: Sealed bearing includes inner ring holes to facilitate grease replenishment.
- Fewer mounted components: With snap rings for the outer ring, fewer components are required around the bearing, making for a more cost-effective sheave.

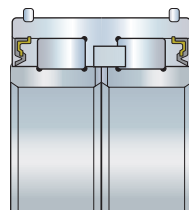

CA-VS Series Spherical Roller Bearings

Standard-sized CA Series bearings feature a machined brass cage and tough, wear-resistant capabilities ideal for heavy or shock load applications. NSK offers U15 and VS units specifically for vibrating screens, feeders, and other vibrating applications.

Features

- Highly resistant to heavy or shock loads.
- Long service life for vibrating applications.
- Excellent self-aligning ability.
- Preventive measures against shaft deflection.
- Easy installation



EMM-VS Series Cylindrical Roller Bearings for Vibrating Equipment

EMM Series: Outer Ring Guided Machined-Brass Cage

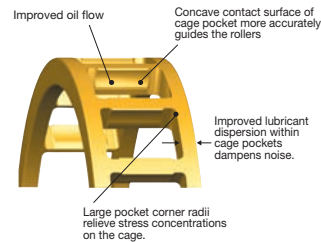

- Machined-brass cage (High strength, wear-resistant cage)
- Outer ring guided one-piece cage

■ Analysis of roller surface pressure

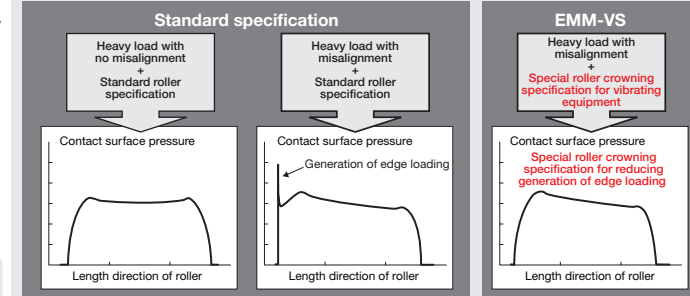

Hi-TF Bearings

Bearings manufactured from NSK's Hi-TF material have been specifically designed for outstanding toughness under harsh operating conditions, surpassing even NSK's earlier TF bearings. Hi-TF bearings incorporate this new material and a new heat-treatment technology to provide long service life under contaminated lubrication conditions with superior resistance to wear, seizure, and heat. Hi-TF bearings meet the rigorous requirements of bearings now and into the future.

Features

Achieves longer bearing life even under harsh conditions with excellent resistance to wear, seizure, and heat

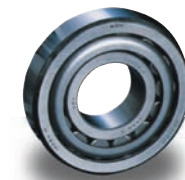
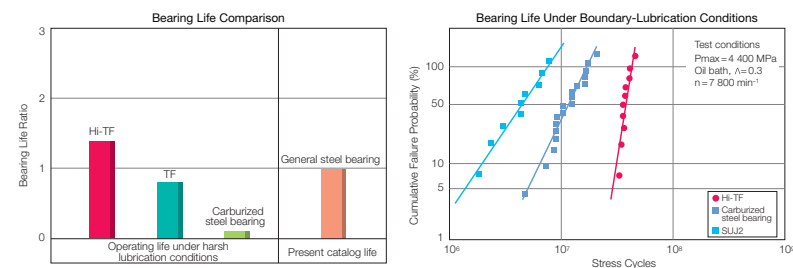

Plummer Blocks

Plummer block housings can be used with high-capacity spherical roller bearings or self-aligning ball bearings. They are manufactured from high-strength cast iron as standard but are also available in cast steel or spheroidal graphite cast iron.



Air Turbine Dental Handpieces
Pumps & Compressors
Agricultural Machinery
Construction Machinery
Mining Machinery
Rolling Stock
Papermaking Machines
Wind Power Industry
Steel Industry

Air Turbine Dental Handpieces
Pumps & Compressors
Agricultural Machinery
Construction Machinery
Mining Machinery
Rolling Stock
Papermaking Machines
Wind Power Industry
Steel Industry

INDUSTRY SOLUTIONS

INDUSTRY SOLUTIONS

■ Bearings for Mining Machinery

CA-VS3 and CA-VS4 Series Super Long-Life Spherical Roller Bearings for Vibrating Equipment

Example: **223 20 CAM E4 -VS3**

Bearing Series (Bearing type+width series+diameter series)
 Bearing bore (Bore number)
 Cage type
 CAM: High load capacity machined-brass cage

•Bearings for vibrating equipment
 •Special accuracy for vibrating equipment
 •Special internal clearance for vibrating equipment

Outer ring with oil groove and oil hole (external features designation)

EMM-VS Series Cylindrical Roller Bearings for Vibrating Equipment

Example: **NU 23 08 EMM C3(4) -VS**

Bearing Type (NU,NJ,NUP)
 Bearing Series
 Bore Number

EMM-VS : Bearings for Vibrating Equipment
 Internal Radial Clearance

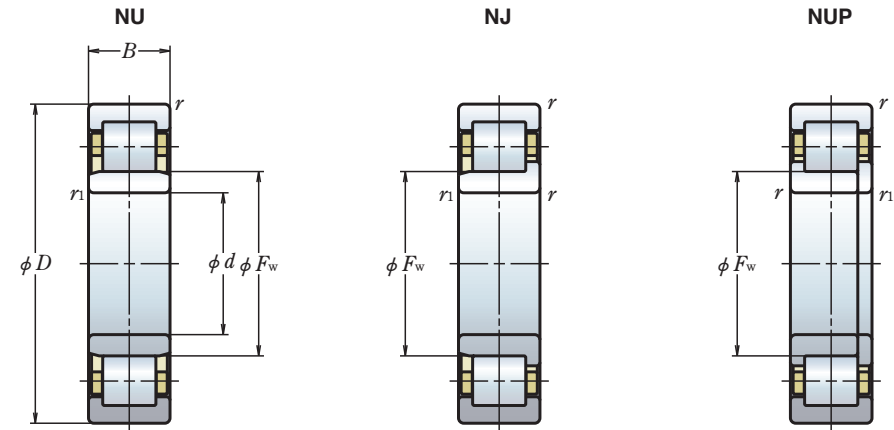

Dimensional Tolerance and Radial Internal Clearance

NSK's VS3 and VS4 specifications stabilize load distribution by controlling the internal clearance and dimensional tolerance of the bearing.

- The VS3 and VS4 Series meet U15 specifications (special tolerance for vibrating equipment) for CAVS Series self-aligning spherical roller bearings; however, to simplify the suffix and clarify the difference between the new and conventional Series, suffix U15 is omitted.
- The numbers in VS3 and VS4 (3 and 4) refer to bearing internal clearance "C3U15" and "C4U15."
- The dimensional tolerance of a bearing is set at 1/2 relative to the outer diameter tolerance and internal diameter tolerance.
- The radial internal clearance is set at 2/3 relative to the standard.

Bearing Designation	Basic Load Ratings (kN)		Boundary Dimensions (mm)				Radial Clearance (Cylindrical Bore)		
	C_r	C_{0r}	d (mm)	Diameter Tolerance (μm)	D (mm)	Diameter Tolerance (μm)	B (mm)	VS3(μm)	VS4(μm)
22308CAME4-VS ()	152 000	129 000	40	0	90	-7	33	50 to 60	65 to 80
22309CAME4-VS ()	185 000	167 000	45	0	100	-7	36	60 to 75	85 to 100
22310CAME4-VS ()	232 000	211 000	50	0	110	-7	40		
22311CAME4-VS ()	261 000	241 000	55	0	120	-13	43	75 to 90	100 to 120
22312CAME4-VS ()	305 000	288 000	60	0	130	-13	46		
22313CAME4-VS ()	330 000	315 000	65	0	140	-13	48		
22314CAME4-VS ()	380 000	370 000	70	-9	150	-13	51	90 to 110	120 to 145
22315CAME4-VS ()	425 000	415 000	75	0	160	-18	55		
22316CAME4-VS ()	485 000	480 000	80	0	170	-18	58		
22317CAME4-VS ()	520 000	510 000	85	0	180	-18	60	110 to 135	150 to 180
22318CAME4-VS ()	605 000	595 000	90	0	190	-23	64		
22319CAME4-VS ()	655 000	675 000	95	0	200	-23	67		
22320CAME4-VS ()	750 000	785 000	100	-12	215	-23	73		
22322CAME4-VS ()	925 000	980 000	110	0	240	-23	80	135 to 160	180 to 210
22324CAME4-VS ()	1 060 000	1 120 000	120	0	260	-23	86		
22326CAME4-VS ()	1 240 000	1 350 000	130	0	280	-28	93	160 to 190	205 to 240
22328CAME4-VS ()	1 450 000	1 590 000	140	0	300	-28	102		
22330CAME4-VS ()	1 530 000	1 690 000	150	0	320	-28	108	190 to 220	240 to 280
22332CAME4-VS ()	1 700 000	1 900 000	160	-15	340	-28	114		
22334CAME4-VS ()	1 970 000	2 110 000	170	0	360	-28	120	200 to 240	260 to 310
22336CAME4-VS ()	2 170 000	2 340 000	180	0	380	-28	126		
22338CAME4-VS ()	2 370 000	2 590 000	190	0	400	-18	132	220 to 260	285 to 340

Remark VS (): Replace the parentheses with the appropriate number (3 or 4) when ordering.

Bearing Designations	Boundary Dimensions (mm)						Basic Load Ratings (N)	
	d	D	B	$r_{min.}$	$r_{1 min.}$	F_w	C_r	C_{0r}
NU2308EMMC3-VS NU2308EMMC4-VS	40	90	33	1.5	1.5	52	114 000	122 000
NU2309EMMC3-VS NU2309EMMC4-VS	45	100	36	1.5	1.5	58.5	137 000	153 000
NU2310EMMC3-VS NU2310EMMC4-VS	50	110	40	2	2	65	163 000	187 000
NU2311EMMC3-VS NU2311EMMC4-VS	55	120	43	2	2	70.5	201 000	233 000
NU2312EMMC3-VS NU2312EMMC4-VS	60	130	46	2	2	77	222 000	262 000
NU2313EMMC3-VS NU2313EMMC4-VS	65	140	48	2.1	2.1	82.5	233 000	265 000
NU2314EMMC3-VS NU2314EMMC4-VS	70	150	51	2.1	2.1	89	274 000	325 000
NU2315EMMC3-VS NU2315EMMC4-VS	75	160	55	2.1	2.1	95	330 000	395 000
NU2316EMMC3-VS NU2316EMMC4-VS	80	170	58	2.1	2.1	101	355 000	430 000
NU2317EMMC3-VS NU2317EMMC4-VS	85	180	60	3	3	108	395 000	485 000
NU2318EMMC3-VS NU2318EMMC4-VS	90	190	64	3	3	113.5	435 000	535 000
NU2319EMMC3-VS NU2319EMMC4-VS	95	200	67	3	3	121.5	460 000	585 000
NU2320EMMC3-VS NU2320EMMC4-VS	100	215	73	3	3	127.5	570 000	715 000
NU2322EMMC3-VS NU2322EMMC4-VS	110	240	80	3	3	143	675 000	880 000
NU2324EMMC3-VS NU2324EMMC4-VS	120	260	86	3	3	154	795 000	1 030 000

Bearings for Railway Rolling Stock

Bearing Tables

Axle Bearings D 052

Gearbox Bearings D 062

Traction Motor Bearings D 064



Air Turbine
Dental
Handpieces

Pumps &
Compressors

Agricultural
Machinery

Construction
Machinery

Mining
Machinery

**Railway
Rolling Stock**

Papermaking
Machines

Wind Power
Industry

Steel Industry

Air Turbine
Dental
Handpieces

Pumps &
Compressors

Agricultural
Machinery

Construction
Machinery

Mining
Machinery

**Railway
Rolling Stock**

Papermaking
Machines

Wind Power
Industry

Steel Industry

INDUSTRY
SOLUTIONS

■ Bearings for Railway Rolling Stock

High reliability is essential for bearings for railway rolling stock. There are three bearing types typically used in rolling stock: axle bearings, which carry the heavy weight of the rolling stock on shafts; traction motor bearings, which support the main shaft of the propulsion motor; and gearbox bearings, which transmit drive power from the traction motor to the axle shaft. NSK supplies specifically designed bearings for each application.



Axle Bearings

- NSK has developed various high-speed, lightweight, and low-maintenance axle bearings:
 - Sealed-Clean rotating end cap tapered roller bearings with grease lubrication
 - Sealed-Clean rotating end cap cylindrical roller bearings with grease lubrication
 - Open cylindrical roller bearings with oil bath or grease lubrication
 - Open tapered roller bearings with oil bath lubrication
- Axle bearings with sensors for higher reliability are also available.
- NSK is certified by the Association of American Railways (AAR). Please consult NSK for details.

Traction Motor Bearings



Axle Bearings

Gearbox Bearings



Gearbox Bearings

- NSK bearings have higher seizure resistance under high-speed rotation due to special designs.
- A high-toughness cage may be used in necessary applications.

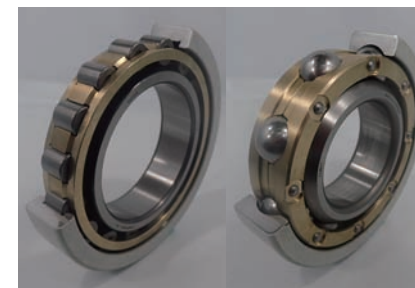

Traction Motor Bearings

- Designed for high-speed, inverter-controlled traction motors thanks to a dimension-stabilizing treatment. Long-life grease is recommended.
- NSK offers two solutions to prevent electric current penetration (electrolytic corrosion):
 - Ceramic-insulated bearings
 - PPS-molded bearings
- High-capacity bearings are used in large traction motors in electric locomotives.

Air Turbine
Dental
Handpieces

Pumps &
Compressors

Agricultural
Machinery

Construction
Machinery

Mining
Machinery

Railway
Rolling Stock

Papermaking
Machines

Wind Power
Industry

Steel Industry

INDUSTRY
SOLUTIONS

Air Turbine
Dental
Handpieces

Pumps &
Compressors

Agricultural
Machinery

Construction
Machinery

Mining
Machinery

Railway
Rolling Stock

Papermaking
Machines

Wind Power
Industry

Steel Industry

INDUSTRY
SOLUTIONS

■ Axle Bearings

Sealed-Clean Rotating End Cap Tapered Roller Bearings

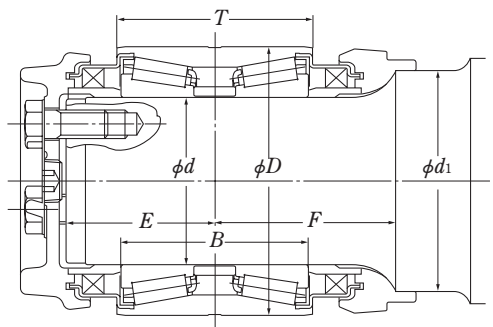

Bearing Designation	Dimensions (mm)							Basic Dynamic Load Rating (N)	Basic Static Load Rating (N)
	d	D	T	B	d_1	E	F		
J-908	90	154	90	80	110	55	80	297 000	480 000
J-318	110	175	130	125	155	105	135	470 000	940 000
J-910	110	188	150	145	150	100	120	605 000	1 110 000
J-901	110	190	150	145	150	100	120	605 000	1 110 000
J-905	110	195	150	145	150	100	120	650 000	1 180 000
J-909	110	205	140	130	150	85	105	745 000	1 270 000
J-902	110	220	145	144	155	112	110	690 000	1 090 000
J-900	115	210	150	145	144	98	117	710 000	1 250 000
J-319	120	195	142	136	155	113	135	645 000	1 290 000
J-904	120	220	145	145	155	120	117	750 000	1 250 000
J-355	120	220	155	155	150	125	100	845 000	1 530 000
J-907A	120	220	155	150	149	146.5	117	780 000	1 310 000
J-320	130	208	152	146	165	115	139	660 000	1 350 000
J-913	130	220	155	155	160	168	100	765 000	1 410 000
J-920	130	220	155	155	171	115	140.7	820 000	1 550 000
J-934	130	230	160	150	149	146.5	117	915 000	1 670 000
J-937	130	230	160	150	160	149	117	915 000	1 670 000
J-936B	130	240	165	160	160	203.5	117	1 040 000	1 800 000
J-943	130	240	160	160	160	90	101	1 040 000	1 800 000
J-921C	150	250	185	179.5	185	122	133	915 000	1 700 000
J-942	185	280	160	155	225	—	115.5	915 000	1 900 000

Air Turbine
Dental
Handpieces

Pumps &
Compressors

Agricultural
Machinery

Construction
Machinery

Mining
Machinery

Railway
Rolling Stock

Papermaking
Machines

Wind Power
Industry

Steel Industry

INDUSTRY
SOLUTIONS

Air Turbine
Dental
Handpieces

Pumps &
Compressors

Agricultural
Machinery

Construction
Machinery

Mining
Machinery

Railway
Rolling Stock

Papermaking
Machines

Wind Power
Industry

Steel Industry

INDUSTRY
SOLUTIONS

■ Axle Bearings

Sealed-Clean Rotating End Cap Tapered Roller Bearings

AAR No.22

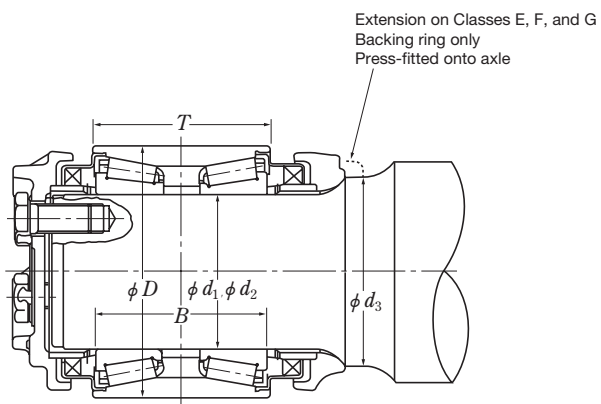

Class	Journal Size	Unit Number	Bearing Designations	Dimensions mm (upper line) / inches (lower line)						Basic Dynamic Load Rating N (lbf)	Basic Static Load Rating N (lbf)
				d_1 (bearing) max.-min.	d_2 (axle) max.-min.	D	T	B	d_3		
B	4 1/4 X 8	J-371	HM120848R HM120817XDR	101.625-101.600 4.001-4.000	101.702-101.676 4.0040-4.0030	165.100 6 1/2	114.300 4 1/2	106.362 4 3/16	127.000 5	415 000 (93 000)	775 000 (174 000)
C	5 X 9	J-372	HM124646R HM124618XDR	119.087-119.062 4.6885-4.6875	119.164-119.139 4.6915-4.6905	195.262 7 11/16	142.875 5 5/8	136.525 5 3/8	149.225 5 7/8	585 000 (132 000)	1 140 000 (255 000)
D	5 1/2 X 10	J-373	HM127446R HM127415XDR	131.775-131.750 5.1880-5.1870	131.864-131.839 5.1915-5.1905	207.962 8 3/16	152.600 6	146.050 5 3/4	161.925 6 3/8	635 000 (143 000)	1 250 000 (282 000)
E	6 X 11	J-374	HM129848R HM129814XDR	144.475-144.450 5.6880-5.6870	144.564-144.539 5.6915-5.6905	220.662 8 11/16	163.512 6 7/16	155.575 6 1/8	178.613-178.562 7.032-7.030	665 000 (149 000)	1 350 000 (305 000)
F	6 1/2 X 12	J-375	HM133444R HM133416XDR	157.175-157.150 6.1880-6.1870	157.264-157.239 6.1915-6.1905	252.412 9 15/16	184.150 7 1/4	177.800 7	191.313-191.262 7.532-7.530	905 000 (204 000)	1 840 000 (415 000)
G	7 X 12	J-376	HM136948R HM136916XDR	177.812-177.787 7.0005-6.9995	177.902-177.876 7.0040-7.0030	276.225 10 7/8	185.725 7.312	180.075 7 1/8	203.251-203.200 8.002-8.000	1 010 000 (227 000)	2 170 000 (485 000)

Air Turbine Dental Handpieces
 Pumps & Compressors
 Agricultural Machinery
 Construction Machinery
 Mining Machinery
 Railway Rolling Stock
 Papermaking Machines
 Wind Power Industry
 Steel Industry

Air Turbine Dental Handpieces
 Pumps & Compressors
 Agricultural Machinery
 Construction Machinery
 Mining Machinery
 Railway Rolling Stock
 Papermaking Machines
 Wind Power Industry
 Steel Industry

■ Axle Bearings

Sealed-Clean Rotating End Cap Cylindrical Roller Bearings

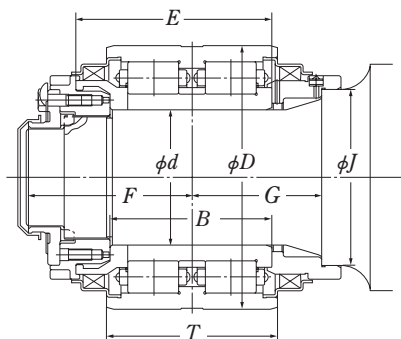

Bearing Designation	Dimensions (mm)								Basic Dynamic Load Rating (N)	Basic Static Load Rating (N)
	<i>d</i>	<i>D</i>	<i>T</i>	<i>B</i>	<i>J</i>	<i>E</i>	<i>F</i>	<i>G</i>		
J-580A	100	195	150	175	130	—	120	105	670 000	1 040 000
J-447B	110	220	160	154	170	—	135	140	875 000	1 370 000
J-577	110	220	170	182	140	210	128	112	875 000	1 370 000
J-504	120	195	140	134	155	176	135	132	545 000	915 000
120JRF11	120	215	146	146	—	—	—	—	830 000	1 350 000
J-809	120	220	145	145	155	171	145	117	700 000	1 120 000
J-805	120	220	155	157	150	190	113	100	765 000	1 250 000
J-806	120	220	160	172	160	200	128	112	765 000	1 250 000
J-810A	120	220	160	185.5	145	—	128	104	765 000	1 250 000
J-811	120	220	160	204	150	242	128	112	815 000	1 320 000
J-817	120	220	175	175	144	197	118	113	850 000	1 430 000
J-605	120	220	175	182	140	210	128	112	850 000	1 430 000
J-803	120	220	175	182	150	210	128	112	850 000	1 430 000
J-594	120	230	150	142	155	171	145	113	830 000	1 290 000
J-574	120	240	160	162	168	193	158	113	935 000	1 420 000
J-574A	120	240	160	162	168	196	120	125	935 000	1 420 000
J-480B	120	240	160	164	150	197	128	112	935 000	1 450 000
J-556B	120	240	170	180	168	218	130	125	1 020 000	1 580 000
J-802	120	240	170	182	150	205	128	112	1 020 000	1 580 000
J130-20DR	130	220	124	124	—	—	—	—	805 000	1 320 000
J-814	130	230	160	185.5	155	—	128	104	800 000	1 340 000
J-816	130	240	160	160	160	188	100	112	825 000	1 310 000
J-807	130	240	160	160	160	188	118	112	825 000	1 310 000
J-801	130	240	160	160	165	188	116	105	825 000	1 310 000
J-589	130	240	160	160	170	188	131	116	825 000	1 310 000
J-567	130	250	170	170	165	208	95	135	1 030 000	1 610 000
J-578	130	260	175	182	160	212.5	128	112	1 030 000	1 610 000
J-555	130	260	180	182	160	215	128	112	1 030 000	1 610 000
160JRT02	160	280	159	180	—	—	—	—	1 060 000	1 730 000

Air Turbine Dental Handpieces
 Pumps & Compressors
 Agricultural Machinery
 Construction Machinery
 Mining Machinery
 Railway Rolling Stock
 Papermaking Machines
 Wind Power Industry
 Steel Industry

INDUSTRY SOLUTIONS

■ Axle Bearings

Open Cylindrical Roller Bearings

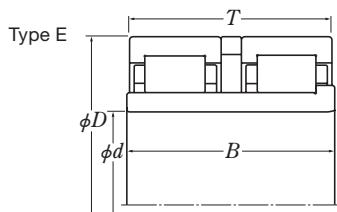

Bearing Designation	Dimensions (mm)				Basic Dynamic Load Rating (N)	Basic Static Load Rating (N)
	<i>d</i>	<i>D</i>	<i>T</i>	<i>B</i>		
85JRJ02	85	150	120.0	125	365 000	585 000
90JRJ01	90	160	118.5	130	355 000	530 000
110JRJ01	110	200	150.0	160	625 000	995 000
2J110-2	110	220	180.0 (80x2)	190	875 000	1 370 000
120JRJ01	120	220	180.0	183	850 000	1 430 000
2J120-1	120	240	180.0 (80x2)	190	935 000	1 450 000
2J120-3M	120	240	180.0 (80x2)	180	935 000	1 450 000

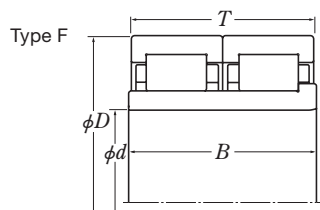

Bearing Designation	Dimensions (mm)				Basic Dynamic Load Rating (N)	Basic Static Load Rating (N)
	<i>d</i>	<i>D</i>	<i>T</i>	<i>B</i>		
2J110-1	110	225	70x2	150	935 000	1 430 000
120JRJ02A	120	240	160	180	935 000	1 450 000

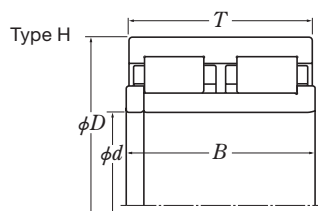

Bearing Designation	Dimensions (mm)				Basic Dynamic Load Rating (N)	Basic Static Load Rating (N)
	<i>d</i>	<i>D</i>	<i>T</i>	<i>B</i>		
JC14	130	260	160	160	1 140 000	1 840 000

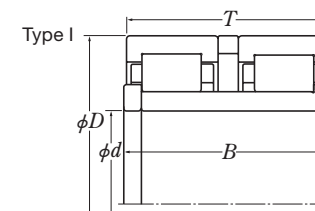

Bearing Designation	Dimensions (mm)				Basic Dynamic Load Rating (N)	Basic Static Load Rating (N)
	<i>d</i>	<i>D</i>	<i>T</i>	<i>B</i>		
95JRT02	95	170	115	125	440 000	685 000
95JRT01	95	190	125	130	800 000	1 340 000
2O100-1	100	200	170	170	650 000	1 030 000
2O110-1	110	220	180	185	875 000	1 370 000
120JRT04	120	220	160	165	810 000	1 340 000
2O120-11	120	220	180	183	850 000	1 430 000
JC34	120	230	165	170	945 000	1 460 000
120JRT01	120	240	180	185	935 000	1 450 000
2O120-4	120	240	180	185	935 000	1 450 000
JC38A	125	235	165	170	945 000	1 470 000
JC39A	125	236	165	175.5	960 000	1 500 000
130JRT08	130	235	165	170	895 000	1 520 000
2O130-7	130	240	180	185	915 000	1 490 000
130JRT01	130	260	180	185	1 030 000	1 610 000
2O130-6	130	260	180	185	1 030 000	1 610 000
JC37A	130	265	166	166	1 140 000	1 700 000
2O140-1	140	250	155	160	865 000	1 480 000
170JRT01	170	340	230	230	1 660 000	2 760 000

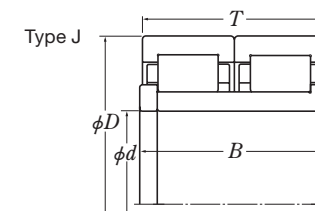

Bearing Designation	Dimensions (mm)				Basic Dynamic Load Rating (N)	Basic Static Load Rating (N)
	<i>d</i>	<i>D</i>	<i>T</i>	<i>B</i>		
JC27X	120	230	150	177	935 000	1 440 000
JC400K	120	230	150	177	885 000	1 340 000

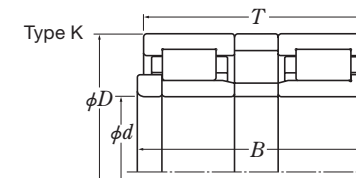

Bearing Designation	Dimensions (mm)				Basic Dynamic Load Rating (N)	Basic Static Load Rating (N)
	<i>d</i>	<i>D</i>	<i>T</i>	<i>B</i>		
J130-5/U130-5DB+KL38	130	240	198 (80x2)	204	880 000	1 450 000

Air Turbine Dental Handpieces
 Pumps & Compressors
 Agricultural Machinery
 Construction Machinery
 Mining Machinery
 Railway Rolling Stock
 Papermaking Machines
 Wind Power Industry
 Steel Industry
 Air Turbine Dental Handpieces
 Pumps & Compressors
 Agricultural Machinery
 Construction Machinery
 Mining Machinery
 Railway Rolling Stock
 Papermaking Machines
 Wind Power Industry
 Steel Industry

■ Axle Bearings

Open Cylindrical Roller Bearings

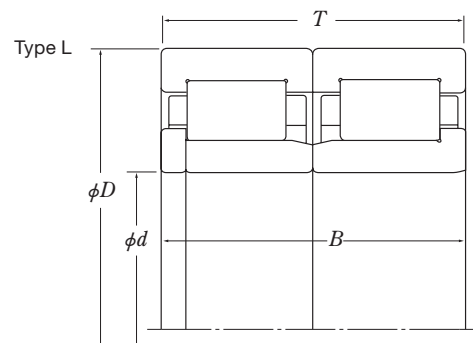

Bearing Designation	Dimensions (mm)				Basic Dynamic Load Rating (N)	Basic Static Load Rating (N)
	d	D	T	B		
J110-2/U110-4DB	110	215	73 × 2	73 × 2	800 000	1 240 000
42724T/152724T	120	240	80 × 2	80 × 2	910 000	1 400 000
J120-1C/U120-2C	120	240	80 × 2	80 × 2	960 000	1 500 000
J120-1D/U120-2D	120	240	80 × 2	80 × 2	960 000	1 500 000
42726TT/152726TT	130	250	80 × 2	80 × 2	1 030 000	1 610 000
J130-3/U130-4	130	250	80 × 2	80 × 2	1 030 000	1 610 000
JC130M	130	250	160	160	1 030 000	1 610 000
J130-18/U130-16	130	220	62 × 2	62 × 2	785 000	1 340 000
J130-16/U130-14	130	220	73 × 2	73 × 2	860 000	1 510 000
J150-5/U150-2	150	270	160 (80 × 2)	160 (80 × 2)	1 020 000	1 700 000

Open Tapered Roller Bearings

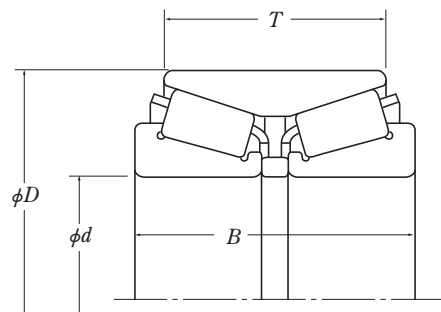

Bearing Designation	Dimensions (mm)				Basic Dynamic Load Rating (N)	Basic Static Load Rating (N)
	d	D	T	B		
110KBE2201+L	110	220	115	145	820 000	1 350 000
120KBE2001+L	120	200	84	100	515 000	865 000
120KBE52X+L	120	215	109	132	720 000	1 170 000
JT21	120	220	130	155	860 000	1 480 000
JT21A	120	220	130	155	860 000	1 480 000
JT21B	120	220	130	155	860 000	1 480 000
130KBE2302+L	130	230	115	145	850 000	1 480 000
140KBE2302+L	140	230	110	140	820 000	1 550 000
140KBE2701+L	140	270	95	120	870 000	1 440 000
150KBE2502+L	150	250	95	115	745 000	1 320 000
160KBE2701A+L	160	270	120	140	860 000	1 510 000
170KBE2802A+L	170	280	130	150	1 110 000	2 160 000
180KBE3401+L	180	340	140	180	1 410 000	2 510 000

■ Gearbox Bearings

Tapered Roller Bearings

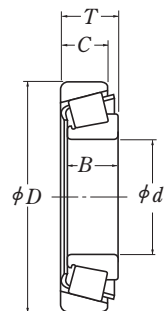

Bearing Designation	Dimensions (mm)					Basic Dynamic Load Rating (N)	Basic Static Load Rating (N)	Application ⁽¹⁾
	<i>d</i>	<i>D</i>	<i>T</i>	<i>B</i>	<i>C</i>			
QT30	60	130	33.5	31	22	127 000	139 000	Gear (P)
30312DQWAP6	60	130	33.5	31	22	127 000	139 000	Gear (P)
30313DQWAP6U1	65	140	36	33	23	147 000	163 000	Gear (P)
QT9	70	150	38	35	25	165 000	185 000	Gear (P)
QT9A	70	150	38	35	25	165 000	185 000	Gear (P)
QT9B-2	70	150	38	35	25	165 000	185 000	Gear (P)
QT9F	70	150	38	35	25	165 000	185 000	Gear (P)
QT9J	70	150	38	35	25	165 000	185 000	Gear (P)
R70-25	70	150	38	35	25	165 000	185 000	Gear (P)
30314DAQWAP6A	70	150	38	35	25	165 000	185 000	Gear (P)
30314QWAP6	70	150	38	35	30	194 000	218 000	Gear (P)
QT31	70	150	40	37	27	172 000	198 000	Gear (P)
QT7A	75	160	40	37	27	189 000	224 000	Gear (P)
30315DXQWAP6	75	160	40	37	26	189 000	224 000	Gear (P)
30315QWAP6	75	160	40	37	31	209 000	233 000	Gear (P)
R80-1	80	170	42.5	39	28	196 000	222 000	Gear (P)
QT4A	80	170	42.5	39	28	208 000	241 000	Gear (P)
30316QWAP6	80	170	42.5	39	33	235 000	265 000	Gear (P)
30317DQWAP6A	85	180	44.5	41	29	233 000	269 000	Gear (P)
30317QWAP6A	85	180	44.5	41	34	262 000	300 000	Gear (P)
QT18	85	180	45.5	42	29	244 000	285 000	Gear (P)
30328QWAP6	140	300	67.75	62	53	600 000	740 000	Gear (G)
QT1⁽²⁾	190	280	49	46	36.5	605 000	1 240 000	Gear (G)
QT29⁽²⁾	193.675	282.575	50.800	47.625	36.512	360 000	600 000	Gear (G)
QT26	195	280	58	60	41	410 000	780 000	Gear (G)
QT25	200	280	51	48	41	410 000	780 000	Gear (G)
32940QSA	200	280	51	48	41	410 000	780 000	Gear (G)
QT13⁽³⁾	200	290	49	46	36.5	625 000	1 330 000	Gear (G)
QT27	200	290	55	60	41	410 000	790 000	Gear (G)
QT34A	202	290	58	60	41	435 000	855 000	Gear (G)
QT33	205	283	51	48	41	415 000	795 000	Gear (G)
QT38	205	310	60	60	47	545 000	1 020 000	Gear (G)
R205-1	205	310	60	60	47	545 000	1 020 000	Gear (G)
R205-4	205	310	60	60	47	545 000	1 020 000	Gear (G)
QT5	210	320	70	66	56	665 000	1 180 000	Gear (G)
QT35	215	315	65	70	49	595 000	1 130 000	Gear (G)
R215-3	215	315	65	70	49	595 000	1 130 000	Gear (G)
QT32	218	315	65	70	49	595 000	1 130 000	Gear (G)
32944QWASA	220	300	51	48	41	425 000	855 000	Gear (G)
32052Q	260	400	87	82	71	1 130 000	2 020 000	Gear (G)

Notes ⁽¹⁾ Gear (P): Pinion-side bearing of gear unit, Gear (G): Gear-side bearing of gear unit

⁽²⁾ Double-row configuration

⁽³⁾ Sizes have been converted to millimeters from inches.

■ Traction Motor Bearings

Bearings for Electric Car Traction Motors

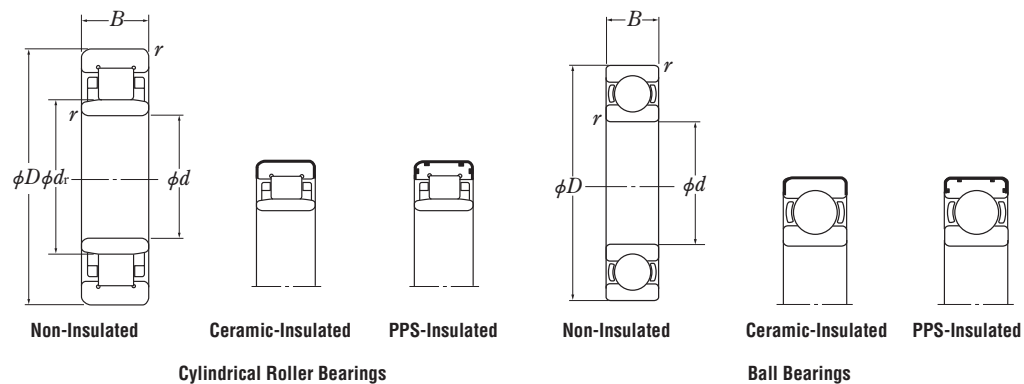

Loaded Side, Cylindrical Roller Bearing	Dimensions (mm)					Non-Loaded Side, Ball Bearing	Dimensions (mm)		
	<i>d</i>	<i>D</i>	<i>B</i>	<i>d_t</i>	<i>r</i> (min.)		<i>d</i>	<i>D</i>	<i>B</i>
NU210E ⁽¹⁾	50	90	20	59.5	1.1	6016	80	125	22
NU212	60	110	22	73.5	1.5	6310	50	110	27
NU312	60	130	31	77.0	2.1	6310	50	110	27
NU213	65	120	23	79.6	1.5	6310	50	110	27
NU313	65	140	33	83.5	2.1	6311	55	120	29
NU214	70	125	24	84.5	1.5	6310	50	110	27
						6311	55	120	29
NU314	70	150	35	90.0	2.1	6311	55	120	29
NU215	75	130	25	88.5	1.5	6312	60	130	31
						6311	55	120	29
NU315	75	160	37	95.5	2.1	6312	60	130	31
						6314	70	150	35
NU415	75	190	45	104.5	3.0	6313	65	140	33
NU216	80	140	26	95.3	2.0	6312	60	130	31
NU316	80	170	39	103.0	2.1	6312	60	130	31
NU416	80	200	48	110.0	3.0	6313	65	140	33
NU217	85	150	28	101.8	2.0	6217	85	150	28
NU218	90	160	30	107.0	2.0	6218	90	160	30
NU219	95	170	32	113.5	2.1	6219	95	170	32

Note ⁽¹⁾ E: High-Capacity

Bearings for Electric Locomotive Traction Motors

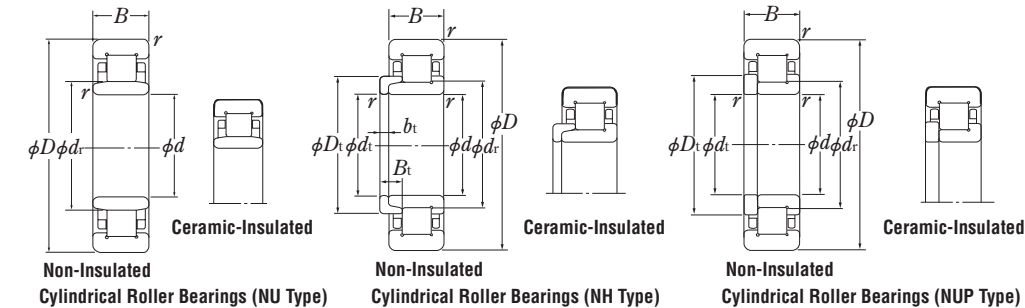

2xx Series (Free End-Bearings)

<i>d</i>	Boundary Dimensions (mm)				<i>r</i> (min.)	Basic Designation	Internal Design ⁽¹⁾	Basic Dynamic Load Rating (N)	Basic Static Load Rating (N)
	<i>D</i>	<i>B</i>	<i>d_t</i>	<i>r</i> (min.)					
120	215	40	143.5	2.1	NU224	E	320 000	395 000	
130	230	40	153.5	3.0	NU226	E	345 000	425 000	

Note ⁽¹⁾ E: High-capacity type

3xx Series (Free End-Bearings)

<i>d</i>	Boundary Dimensions (mm)				<i>r</i> (min.)	Basic Designation	Internal Design ⁽¹⁾	Basic Dynamic Load Rating (N)	Basic Static Load Rating (N)
	<i>D</i>	<i>B</i>	<i>d_t</i>	<i>r</i> (min.)					
90	190	43	113.5	3	NU318	E	315 000	355 000	
100	215	47	127.5	3	NU320	E	380 000	425 000	
110	240	50	143.0	3	NU322	E	425 000	485 000	
120	260	55	154.0	3	NU324	E	530 000	610 000	
130	280	58	165.0	4	NU326	B	655 000	795 000	
			167.0			E	615 000	735 000	
140	300	62	180.0	4	NU328	E	665 000	795 000	
			178.0			F	705 000	860 000	
150	320	65	193.0	4	NU330	E	760 000	920 000	
			193.0			EA	715 000	855 000	
			190.5			J	800 000	985 000	
160	340	68	204.0	4	NU332	L	790 000	970 000	
			190.0			E	860 000	1 050 000	
180	380	75	231.0	4	NU336	E	985 000	1 230 000	

Note ⁽¹⁾ E, EA: High-capacity type B, F, J, L: Special specification

3xx Series (NH Type, NUP Type)

<i>d, d_t</i>	Dimensions (mm)							Basic Designation	Internal Design ⁽¹⁾	Basic Dynamic Load Rating (N)	Basic Static Load Rating (N)
	<i>D</i>	<i>B</i>	<i>d_t</i>	<i>D_t</i>	<i>B_t</i>	<i>b_t</i>	<i>r</i> (min.)				
80	170	39	101.0	111.8	17.0	11.0	2.1	NH316	E	256 000	282 000
90	190	43	115.0	125.0	21.0	12.0	3.0	NH318	—	240 000	265 000
			113.5	124.2	18.5				E	315 000	355 000
90	190	43	115.0	125.0	—	—	3.0	NUP318	E	240 000	265 000
			113.5	124.2					B	315 000	355 000
100	215	47	129.5	140.5	22.5	13.0	3.0	NH320	A	310 000	355 000
			129.5	140.5	22.5				B	310 000	355 000
			127.5	139.0	20.5				E	380 000	425 000
110	240	50	143.0	155.0	22.0	14.0	3.0	NH322	E	425 000	485 000
120	260	55	154.0	168.5	23.5	14.0	3.0	NH324	—	475 000	550 000
130	280	58	167.0	182.0	24.0	14.0	4.0	NH326	—	560 000	665 000
			181.0						E	615 000	735 000
140	300	62	180.0	196.0	26.0	15.0	4.0	NH328	—	615 000	745 000

Note ⁽¹⁾ E: High-capacity type A, B: Special specification

Air Turbine Dental Handpieces
 Pumps & Compressors
 Agricultural Machinery
 Construction Machinery
 Mining Machinery
 Railway Rolling Stock
 Papermaking Machines
 Wind Power Industry
 Steel Industry
 INDUSTRY SOLUTIONS

Bearings for Papermaking Machines

Bearings featuring excellent durability under wet, dusty, and high-temperature environments resulting in longer life, higher limiting speed, and dramatically enhanced productivity.

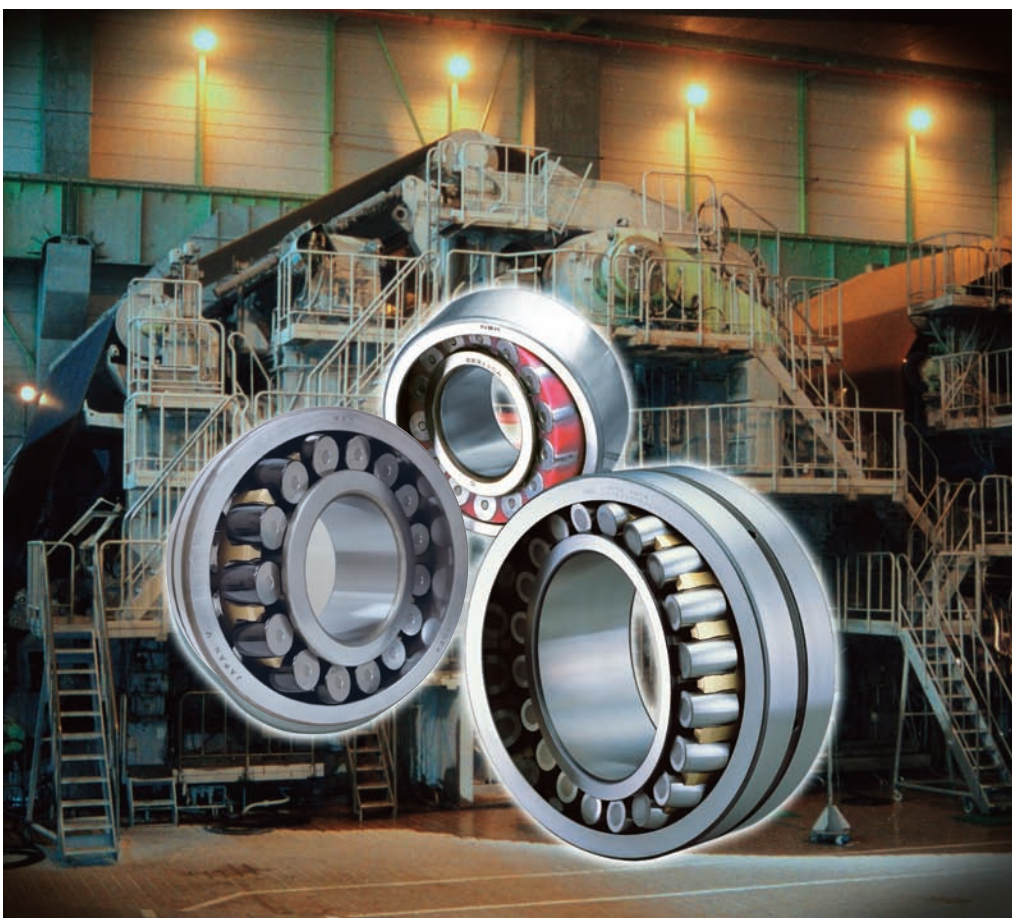

The Papermaking Process and Bearing Specifications D 068

Bearing Tables

TL Series Spherical Roller Bearings D 076

Molded-Oil™ Bearings D 082

Triple Ring Bearings D 084

■ Bearings for Papermaking Machines

The Papermaking Process and Bearing Specifications

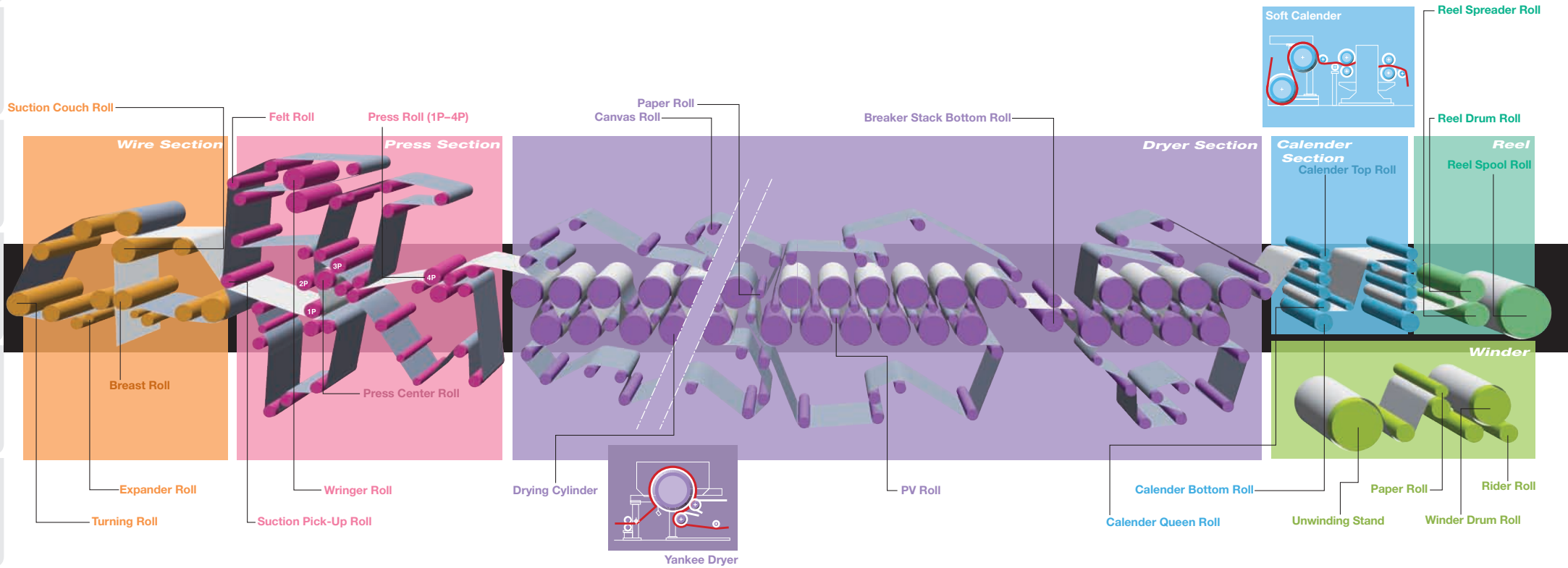

Molded-Oil™ Bearings
 These bearings provide excellent performance without oil leakage in environments with moisture or paper dust. Molded-Oil uses an optimized molding method and composition that enables high-speed operation, allows for easy handling, and is environmentally friendly.
 Major applications: raw material conveyors, carrier rope sheaves, suction rolls



Triple Ring Bearings
 Easy-to-use, uniquely structured bearings that feature no creep, high precision, and long life.
 Major applications: press rolls, breaker stack rolls



Smear-Resistant Spherical Roller Bearings
 Bearings with improved anti-smearing performance through a DLC coating on the rolling elements.
 Major applications: Inner side bearings for suction rolls, soft calendar rolls



CA Series Spherical Roller Bearings
 Featuring superior radial load capacity, alignment, and excellent strength, these bearings are equipped with a machined cage and conform to high running accuracy requirements (ISO tolerance Class 5).
 Major applications: large diameter rolls such as suction rolls, press rolls, calender rolls and reel drum rolls.



TL Series Spherical Roller Bearings
 Ideal for high temperature equipment, these tough and long-life bearings resist inner ring fracture, boost productivity, and lower costs.
 Major applications: Press Roll, Drying Roll, Canvas Roll, PV Roll, Calender Roll



Deep Groove Ball Bearings for High-Speed Expander Rolls
 Special bearings that suppress friction torque and surface damage such as smearing.

Air Turbine Dental Handpieces
 Pumps & Compressors
 Agricultural Machinery
 Construction Machinery
 Mining Machinery
 Railway Rolling Stock
 Papermaking Machines
 Wind Power Industry
 Steel Industry
 INDUSTRY SOLUTIONS

Air Turbine Dental Handpieces
 Pumps & Compressors
 Agricultural Machinery
 Construction Machinery
 Mining Machinery
 Railway Rolling Stock
 Papermaking Machines
 Wind Power Industry
 Steel Industry
 INDUSTRY SOLUTIONS

■ Bearings for Papermaking Machines

High-Performance Standard Bearings for Industrial Machinery

NSKHPS™ bearings redefine the standard.

The new NSKHPS Series fully incorporates the advantages of NSK's world-class design, materials, and manufacturing technologies into new products with greater strength and higher accuracy, setting a new standard for bearings.

NSKHPS™ Spherical Roller Bearings

Features

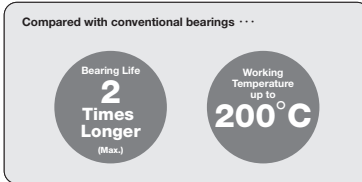

1. Improved reliability

Bearing life is up to double that of conventional bearings through optimization of the bearing's internal design and improved processing technology.

As a result, NSKHPS bearings reduce maintenance costs and facilitate the downscaling of related equipment.

2. High-temperature dimensional stabilizing treatment as standard

High-temperature dimensional stabilization up to 200 °C is achieved through the application of NSK's proprietary material heat treatment technology.

As a result, NSKHPS bearings can be used in a wide range of applications.

3. Wide lineup

A wide range of bearings are available, including giant and wide-roll sizes.

Designations Pages C266 to C287

NSKHPS™ Cylindrical Roller Bearings

Features

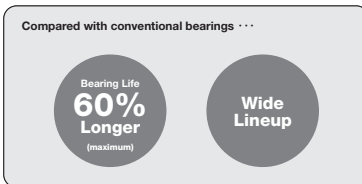

1. Improved reliability

Bearing life is up to 60% longer compared to conventional bearings thanks to optimization of the bearing's internal design and improvement of processing technology.

2. Wide product lineup

NSK offers NSKHPS bearings with four types of cages featuring a range of sizes for a high degree of versatility across general-purpose applications:

- Pressed-steel cage with high cost-performance
- Highly reliable machined-brass cage
- Polyamide-resin cage with excellent heat and chemical resistance

Designations Pages C132 to C147

TL Series Spherical Roller Bearings

Dryer rolls are generally used under high-temperature conditions that can lead to fracture of the bearing inner ring, which may result in work stoppage. NSK's TL Series bearings offer long life, sufficient strength to resist inner ring fractures, superior dimensional stability under high-temperature conditions, and long life due to superior hardness. These characteristics all contribute to greatly improved productivity.



<Applications>

Used in all applications excluding drying/calender rolls and large-size bearings for press rolls.

Designations Pages D076 to D081

Features

Enhanced inner ring strength

Adoption of special steel- and surface-hardening heat treatments developed by NSK dramatically enhance inner ring strength against increasing hoop stress caused by rising shaft temperature.

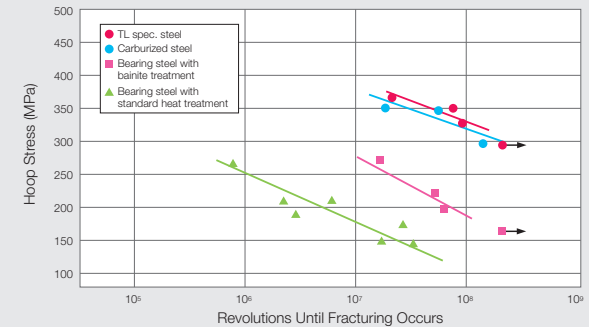

Longer life

Increased hardness of the raceway surface provides longer life when foreign debris is present.

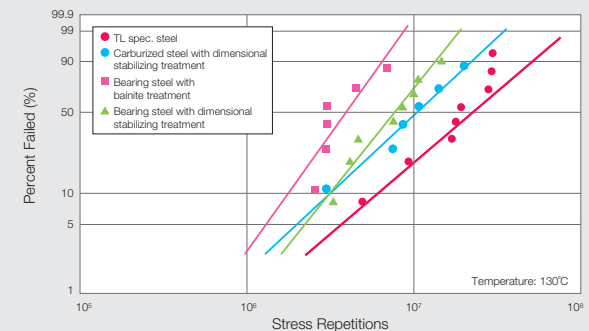

Dimensional stability under high temperatures

Dimensional stability under high temperatures is standard. (Max. 200 °C)

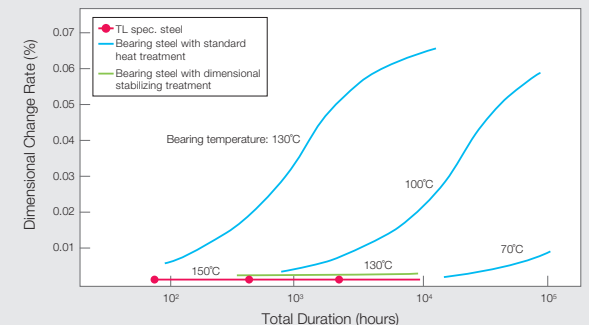

Air Turbine Dental Handpieces
 Pumps & Compressors
 Agricultural Machinery
 Construction Machinery
 Mining Machinery
 Railway Rolling Stock
 Papermaking Machines
 Wind Power Industry
 Steel Industry
 INDUSTRY SOLUTIONS

Bearings for Papermaking Machines

Molded-Oil™ Bearings

Molded-Oil™ bearings are lubricated with NSK's own special oil-containing material. Molded-Oil consists of lubricating oil and a polyolefin resin with an affinity for oil. Oil slowly seeping from this material provides ample lubrication to the bearing for extended periods.

Designations Pages D082 and D083

CAT. No. E1216

Features

Excellent performance in water- and dust-contaminated environments

Molded-Oil bearings are designed to prevent the entry of dust and liquids such as water, which can wash out the oil. Sealed types can be used in contaminated environments.

*Water and dust dramatically accelerate bearing damage. In order to realize stable operation, we recommend using seals to prevent water and dust from getting in the bearing.

Optimal composition and molding methods enable high-speed operation

Optimization of composition and molding improves strength and enables high-speed operation.

Low torque

Packing the bearing with Molded-Oil after surface treatment allows for smooth rotation of rolling elements.

Environmentally friendly

Bearings are lubricated by small quantities of oil diffused by the Molded-Oil, consequently minimizing oil leakage.



<Applications>

Material processing equipment (conveyors, agitators), paper mill line equipment (support for wire part rolls), maintenance facilities (carrier rope sheave pulley), and carrier line equipment

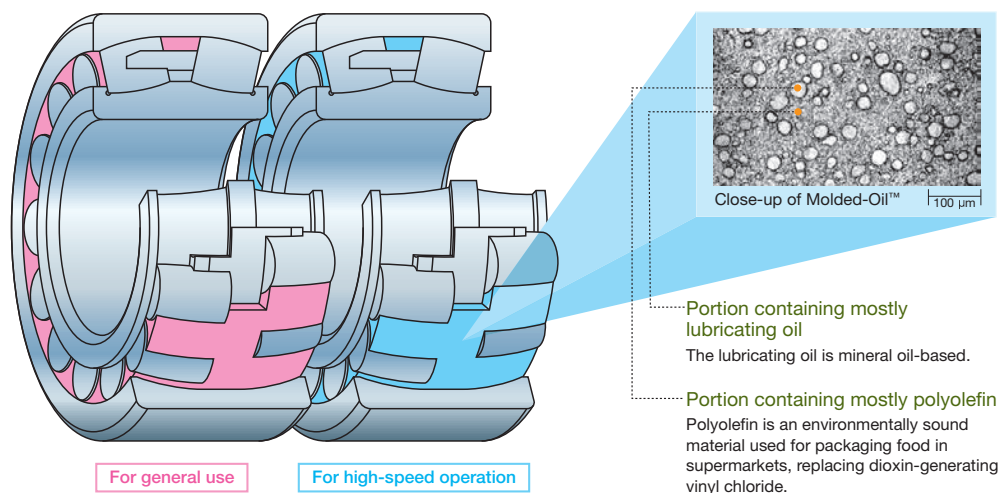

Note that this bearing has certain restrictions in regards to ambient operating temperatures and limiting speeds ($d_m n$). Refer to the Molded-Oil bearings catalog (Cat. No. E1216) for details. See Page 3 of the same catalog for relevant handling precautions.

Smear-Resistant Spherical Roller Bearings

Newly developed smear-resistant spherical roller bearings feature improved durability thanks to NSK's original DLC* coating on the rolling contact surface of the rollers.

*DLC: Hard coating mainly consisting of carbon (diamond-like carbon)

The phenomenon of smearing or micro-seizing caused by slippage between the raceway surface of the inner and outer rings and the roller surface may occur in bearings used under light load inside papermaking machinery and in applications with poor lubrication.

A DLC coating drastically improves anti-smearing performance.



Inner bore dimensions ranging from 80 mm to 240 mm

<Applications>

- Inner side bearings for suction rolls in press section
- Bearings for soft calender rolls in calender section

Features

NSK independently developed its DLC coating for bearings. Because the elastic modulus of the coating is close to that of the substrate base, the coating can better follow the elastic deformation of the base metal. The adhesion of the coating to the base metal is also improved, making it less likely to be removed even at high surface pressure.

Conventional DLC coating

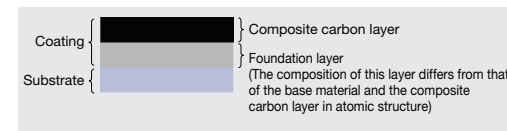

NSK DLC coating

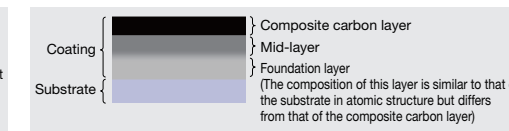

Fig. 1

Twin-disc test

Two disc test pieces

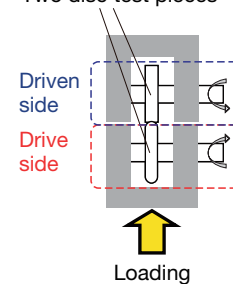
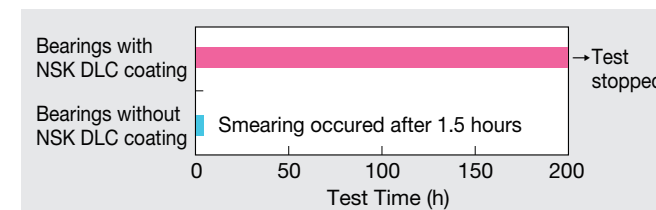

Fig. 2

A rolling-contact test was conducted under boundary lubrication conditions and sliding contact conditions in which the speeds of two disc test pieces were set differently. (Fig. 2)



■ Bearings for Papermaking Machines

Triple Ring Bearings

Combination tapered roller bearings have typically been used for the outside of controlled crown rolls (CCR) and spherical roller bearings for the inside. Switching to high-precision, high load capacity triple ring bearings prevents creep, facilitates easier mounting, and extends operating life.



Designations Page D084

Features

High-load capacity design

Long life
(uses vacuum-melted, carburized steel)

High precision
(dimensional and rotational precision)

Optimal inner ring design for lubrication

Lubrication hole and groove provided on inner and outer rings

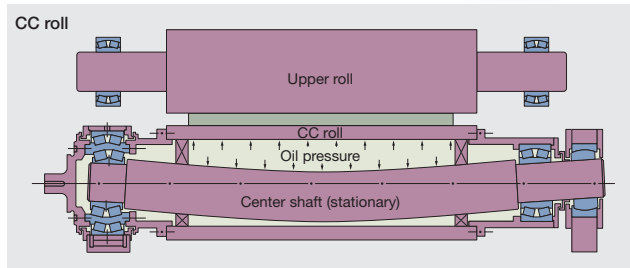

Finite element analysis of housing design for triple ring bearings.

Bearing load distribution is minimized by finite element method (FEM) analysis, thereby contributing to an optimized structural design of the housing for paper machine manufacturers.

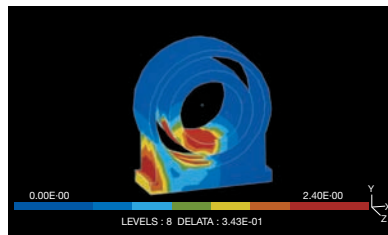

Maximum principal stress distribution

Deep Groove Ball Bearings

Deep groove ball bearings are characterized by high performance and quality. This top-of-the-line design includes special bearings with low friction torque that minimize surface damage such as smearing in high-speed expander rolls, maintenance-free sealed ball bearings with high-performance seals, and silent ball bearings suitable for motors and pumps.



Bearing Designations

TL Series Spherical Roller Bearings

Bearing Designation

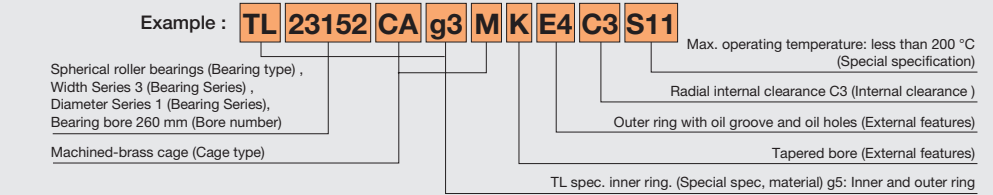

Molded-Oil™ Bearings

Bearing Designation

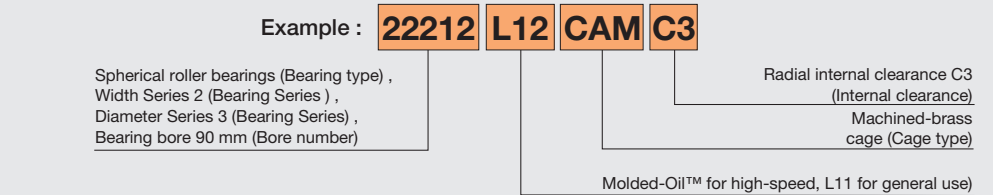

Triple Ring Bearings

Bearing Designation

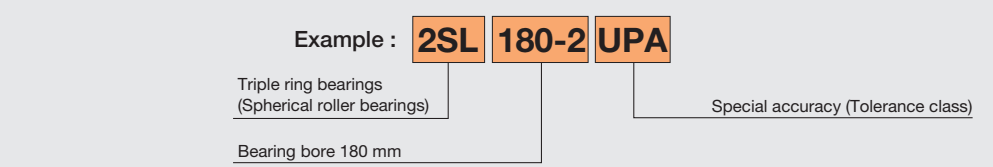

Air Turbine Dental Handpieces
 Pumps & Compressors
 Agricultural Machinery
 Construction Machinery
 Mining Machinery
 Railway Rolling Stock
 Papermaking Machines
 Wind Power Industry
 Steel Industry
 INDUSTRY SOLUTIONS

Air Turbine Dental Handpieces
 Pumps & Compressors
 Agricultural Machinery
 Construction Machinery
 Mining Machinery
 Railway Rolling Stock
 Papermaking Machines
 Wind Power Industry
 Steel Industry
 INDUSTRY SOLUTIONS

TL Series Spherical Roller Bearings

Bore Diameter 40 – 160 mm

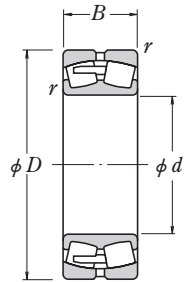

Cylindrical Bore

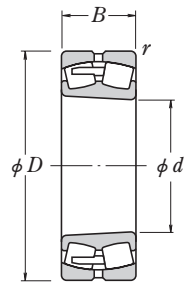

Tapered Bore

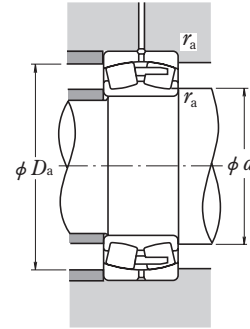

Dynamic Equivalent Load

$$P = XF_r + YF_a$$

$F_a/F_r \leq e$		$F_a/F_r > e$	
X	Y	X	Y
1	Y_3	0.67	Y_2

Static Equivalent Load

$$P_0 = F_r + Y_0 F_a$$

The values of e , Y_2 , Y_3 , and Y_0 are given in the table below.

Boundary Dimensions (mm)				Basic Load Ratings				Bearing Designations	Abutment and Fillet Dimensions (mm)				Constant	Axial Load Factors			Mass (kg)		
d	D	B	r min.	C_r	C_{0r}	C_r	C_{0r}		Cylindrical Bore		Tapered Bore ⁽¹⁾			e	Y_2	Y_3		Y_0	
40	90	33	1.5	122	129	12 400	13 200	TL22308CAME4	TL22308CAMKE4	49	—	81	77	1.5	0.38	2.6	1.8	1.7	1.0
55	120	43	2	209	241	21 300	24 600	TL22311CAME4	TL22311CAMKE4	65	—	110	103	2	0.36	2.8	1.9	1.8	2.3
60	130	46	2.1	246	288	25 100	29 400	TL22312CAME4	TL22312CAMKE4	72	—	118	111	2	0.36	2.8	1.9	1.9	2.9
65	140	48	2.1	375	380	38 000	38 500	TL22313EAE4	TL22313EAKE4	77	84	128	119	2	0.33	3.0	2.0	2.0	3.5
70	150	51	2.1	425	435	43 500	44 000	TL22314EAE4	TL22314EAKE4	82	91	138	129	2	0.33	3.0	2.0	2.0	4.3
75	130	31	2.1	340	415	34 500	42 000	TL22315CAME4	TL22215CAMKE4	87	—	148	134	2	0.35	2.9	2.0	1.9	3.6
80	170	58	2.1	390	480	39 500	48 500	TL22316CAME4	TL22316CAMKE4	92	—	158	145	2	0.35	2.9	2.0	1.9	6.2
90	190	64	3	665	705	68 000	72 000	TL22318EAE4	TL22318EAKE4	104	115	176	163	2.5	0.33	3.1	2.1	2.0	8.6
95	200	67	3	525	675	53 500	68 500	TL22319CAME4	TL22319CAMKE4	109	—	186	172	2.5	0.35	2.9	1.9	1.9	9.9
100	215	73	3	860	930	88 000	94 500	TL22320EAE4	TL22320EAKE4	114	130	201	184	2.5	0.33	3.0	2.0	2.0	12.7
110	170	45	2	293	465	29 900	47 500	TL23022CDE4	TL23022CDKE4	120	124	160	153	2	0.24	4.2	2.8	2.8	3.76
	200	69.8	2.1	515	760	52 500	77 500	TL23222CE4	TL23222CKE4	122	130	188	170	2	0.34	3.0	2.0	1.9	9.54
	240	80	3	1 030	1 120	105 000	115 000	TL22322EAE4	TL22322EAKE4	124	145	226	206	2.5	0.30	3.1	2.1	2.0	17.6
120	260	86	3	1 190	1 320	122 000	134 000	TL22324EAE4	TL22324EAKE4	134	157	246	222	2.5	0.32	3.1	2.1	2.0	22.2
130	280	93	4	995	1 350	101 000	137 000	TL22326CAME4	TL22326CAMKE4	148	—	262	236	3	0.34	2.9	2.0	1.9	27.8
140	210	53	2	420	715	43 000	73 000	TL23028CDE4	TL23028CDKE4	150	157	200	190	2	0.22	4.5	3.0	2.9	6.49
	250	68	3	645	930	65 500	95 000	TL22228CDE4	TL22228CDKE4	154	167	236	219	2.5	0.25	4.0	2.7	2.6	14.5
	250	88	3	835	1 300	85 000	133 000	TL23228CE4	TL23228CKE4	154	163	236	213	2.5	0.25	2.9	1.9	1.9	18.8
150	225	56	2.1	470	815	48 000	83 000	TL23030CDE4	TL23030CDKE4	162	168	213	203	2	0.22	4.6	3.1	3.0	7.9
	225	56	2.1	470	815	48 000	83 000	TL23030CAME4	TL23030CAMKE4	162	—	213	203	2	0.22	4.6	3.1	3.0	7.9
	250	80	2.1	725	1 180	74 000	121 000	TL23130CAME4	TL23130CAMKE4	162	—	238	218	2	0.3	3.4	2.3	2.2	15.8
	270	73	3	765	1 120	78 000	114 000	TL22230CDE4	TL22230CDKE4	164	179	256	236	2.5	0.26	3.9	2.6	2.5	18.4
	320	108	4	1 220	1 690	125 000	172 000	TL22330CAME4	TL22330CAMKE4	168	—	302	270	3	0.35	2.9	1.9	1.9	41.5
160	240	60	2.1	540	955	55 000	97 500	TL23032CDE4	TL23032CDKE4	172	179	228	216	2	0.22	4.5	3.0	2.9	9.66
	290	80	3	910	1 320	93 000	135 000	TL22232CDE4	TL22232CDKE4	174	190	276	255	2.5	0.26	3.8	2.6	2.5	23.1
	290	104	3	1 100	1 770	112 000	180 000	TL23232CE4	TL23232CKE4	174	189	276	245	2.5	0.34	2.9	2.0	1.9	30.5

Note ⁽¹⁾ Suffix K indicates bearings with tapered bores (taper 1:12).

Remark Suffix E4 indicates bearings with an oil groove and holes.

Air Turbine Dental Handpieces
 Pumps & Compressors
 Agricultural Machinery
 Construction Machinery
 Mining Machinery
 Railway Rolling Stock
 Papermaking Machines
 Wind Power Industry
 Steel Industry
 INDUSTRY SOLUTIONS

TL Series Spherical Roller Bearings

Bore Diameter 170 – 260 mm

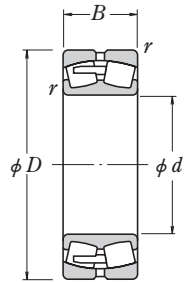

Cylindrical Bore

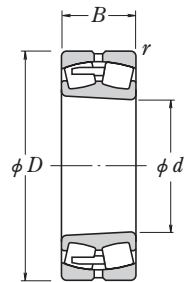

Tapered Bore

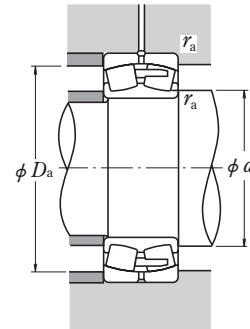

Dynamic Equivalent Load

$$P = X F_r + Y F_a$$

$F_a/F_r \leq e$		$F_a/F_r > e$	
X	Y	X	Y
1	Y_3	0.67	Y_2

Static Equivalent Load

$$P_0 = F_r + Y_0 F_a$$

The values of e , Y_2 , Y_3 , and Y_0 are given in the table below.

Boundary Dimensions (mm)				Basic Load Ratings				Bearing Designations	Abutment and Fillet Dimensions (mm)				Constant e	Axial Load Factors			Mass (kg) approx.		
d	D	B	r min.	C_r (kN)	C_{0r} (kgf)	C_r (kN)	C_{0r} (kgf)		Cylindrical Bore	Tapered Bore ⁽¹⁾	d_a min.	d_a max.		D_a max.	r_a min.	r_a max.		Y_2	Y_3
170	230	45	2	350	660	35 500	67 500	TL23934BCAME4	TL23934BCAMKE4	180	—	220	213	2	0.17	5.8	3.9	3.8	5.38
	260	67	2.1	640	1 090	65 000	112 000	TL23034CDE4	TL23034CDKE4	182	191	248	233	2	0.23	4.3	2.9	2.9	13
	280	88	2.1	940	1 570	96 000	160 000	TL23134CAME4	TL23134CAMKE4	182	—	268	245	2	0.29	3.5	2.3	2.3	21
	360	120	4	1 580	2 110	161 000	215 000	TL22334CAME4	TL22334CAMKE4	188	—	342	304	3	0.35	2.9	1.9	1.9	57.9
180	280	74	2.1	750	1 270	76 000	129 000	TL23036CDE4	TL23036CDKE4	192	202	268	249	2	0.24	4.2	2.8	2.8	17.1
	320	112	4	1 300	2 110	133 000	215 000	TL23236CAME4	TL23236CAMKE4	198	—	302	274	3	0.35	2.9	1.9	1.9	38.5
190	290	75	2.1	775	1 350	79 000	138 000	TL23038CAME4	TL23038CAMKE4	202	—	278	261	2	0.24	4.2	2.8	2.8	17.6
	320	104	3	1 190	2 020	121 000	206 000	TL23138CAME4	TL23138CAMKE4	204	—	306	276	3.5	0.31	3.2	2.2	2.1	34
	340	92	4	1 140	1 730	116 000	176 000	TL22238CAME4	TL22238CAMKE4	208	—	322	296	3	0.26	3.8	2.6	2.5	35.5
200	340	120	4	1 440	2 350	147 000	240 000	TL23238CAME4	TL23238CAMKE4	208	—	322	288	3	0.35	2.9	1.9	1.9	46.5
	400	132	5	1 890	2 590	193 000	264 000	TL22338CAME4	TL22338CAMKE4	212	—	378	338	4	0.34	2.9	2.0	1.9	77.6
200	310	82	2.1	940	1 700	96 000	174 000	TL23040CAME4	TL23040CAMKE4	212	—	298	279	2	0.25	4.0	2.7	2.6	22.6
	340	112	3	1 360	2 330	139 000	238 000	TL23140CAME4	TL23140CAMKE4	214	—	326	293	2.5	0.32	3.2	2.1	2.1	41.5
	360	98	4	1 300	2 010	133 000	204 000	TL22240CAME4	TL22240CAMKE4	218	—	342	315	3	0.26	3.8	2.6	2.5	42.6
	360	128	4	1 660	2 750	169 000	281 000	TL23240CAME4	TL23240CAMKE4	218	—	342	307	3	0.35	2.9	1.9	1.9	57
220	340	90	3	1 090	1 980	111 000	202 000	TL23044CAME4	TL23044CAMKE4	234	—	326	302	2.5	0.24	4.1	2.8	2.7	29.7
	370	120	4	1 570	2 710	160 000	276 000	TL23144CAME4	TL23144CAMKE4	238	—	352	320	3	0.31	3.2	2.2	2.1	52
	400	108	4	1 570	2 430	160 000	247 000	TL22244CAME4	TL22244CAMKE4	238	—	382	348	3	0.27	3.7	2.5	2.4	59
240	400	144	4	2 520	3 400	257 000	350 000	TL23244CAME4	TL23244CAMKE4	238	—	382	337	3	0.36	2.8	1.9	1.8	79.5
	460	145	5	2 350	3 400	240 000	345 000	TL22344CAME4	TL22344CAMKE4	242	—	438	391	4	0.33	3.0	2.0	2.0	116
240	320	60	2.1	635	1 300	65 000	133 000	TL23948CAME4	TL23948CAMKE4	252	—	308	298	2	0.17	6.0	4.0	3.9	13.3
	350	92	3	1 160	2 140	118 000	218 000	TL23048CAME4	TL23048CAMKE4	254	—	346	324	2.5	0.24	4.2	2.8	2.7	32.6
	400	128	4	1 790	3 100	182 000	320 000	TL23148CAME4	TL23148CAMKE4	258	—	382	347	3	0.31	3.3	2.2	2.2	64.5
	500	155	5	2 600	3 800	265 000	385 000	TL22348CAME4	TL22348CAMKE4	262	—	478	423	4	0.32	3.2	2.1	2.1	147
250	350	75	2.1	930	1 870	95 000	191 000	TL23952CAME4	TL23952CAMKE4	272	—	348	333	2	0.19	5.4	3.6	3.5	23
	400	104	4	1 430	2 580	145 000	263 000	TL23052CAME4	TL23052CAMKE4	278	—	382	356	3	0.25	4.1	2.7	2.7	46.6
260	440	144	4	2 160	3 750	221 000	385 000	TL23152CAME4	TL23152CAMKE4	278	—	422	380	3	0.32	3.2	2.1	2.1	88.2

Note ⁽¹⁾ Suffix K indicates bearings with tapered bores (taper 1:12).

Remark Suffix E4 indicates bearings with an oil groove and holes.

Air Turbine Dental Handpieces
 Pumps & Compressors
 Agricultural Machinery
 Construction Machinery
 Mining Machinery
 Railway Rolling Stock
 Papermaking Machines
 Wind Power Industry
 Steel Industry

Air Turbine Dental Handpieces
 Pumps & Compressors
 Agricultural Machinery
 Construction Machinery
 Mining Machinery
 Railway Rolling Stock
 Papermaking Machines
 Wind Power Industry
 Steel Industry

INDUSTRY SOLUTIONS

INDUSTRY SOLUTIONS

TL Series Spherical Roller Bearings

Bore Diameter 280 – 500 mm

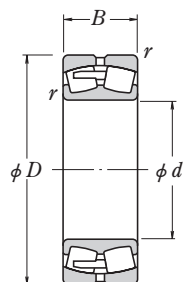

Cylindrical Bore

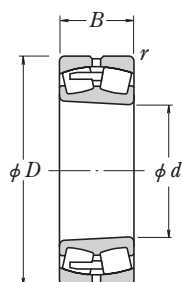

Tapered Bore

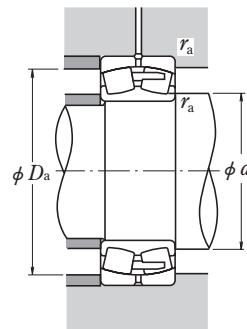

Dynamic Equivalent Load

$$P = XF_r + YF_a$$

$F_a/F_r \leq e$		$F_a/F_r > e$	
X	Y	X	Y
1	Y_3	0.67	Y_2

Static Equivalent Load

$$P_0 = F_r + Y_0 F_a$$

The values of e , Y_2 , Y_3 , and Y_0 are given in the table below.

Boundary Dimensions (mm)				Basic Load Ratings				Bearing	Designations	Abutment and Fillet Dimensions (mm)					Constant	Axial Load Factors			Mass (kg)
d	D	B	r min.	C_r	C_{0r}	C_r	C_{0r}			Cylindrical Bore	Tapered Bore ⁽¹⁾	d_a min.	d_a max.	D_a max.		D_a min.	r_a max.	e	
280	380	75	2.1	925	1 950	94 500	199 000	TL23956CAME4 TL23056CAME4 TL23156CAME4 TL23256CAME4	TL23956CAMKE4 TL23056CAMKE4 TL23156CAMKE4 TL23256CAMKE4	292	—	368	351	2	0.18	5.7	3.9	3.8	24.5
	420	106	4	1 540	2 950	157 000	300 000			298	—	402	377	3	0.24	4.2	2.8	2.7	50.5
	460	146	5	2 230	4 000	228 000	410 000			302	—	438	400	4	0.3	3.3	2.2	2.2	94.3
	500	176	5	2 880	4 900	294 000	500 000			302	—	478	425	4	0.35	2.9	1.9	1.9	147
300	420	90	3	1 230	2 490	125 000	254 000	TL23960CAME4 TL23060CAME4 TL23160CAME4 TL23260CAME4	TL23960CAMKE4 TL23060CAMKE4 TL23160CAMKE4 TL23260CAMKE4	314	—	406	386	2.5	0.19	5.2	3.5	3.4	38.2
	460	118	4	1 920	3 700	196 000	375 000			318	—	442	413	3	0.24	4.2	2.8	2.7	70.5
	500	160	5	2 670	4 800	273 000	490 000			322	—	478	433	4	0.31	3.3	2.2	2.2	125
	540	192	5	3 400	5 900	350 000	600 000			322	—	518	458	4	0.35	2.9	1.9	1.9	189
320	540	176	5	3 050	5 500	315 000	560 000	TL23164CAME4	TL23164CAMKE4	342	—	518	466	4	0.31	3.2	2.1	2.1	162
340	520	133	5	2 280	4 400	232 000	445 000	TL23068CAME4 TL23168CAME4	TL23068CAMKE4 TL23168CAMKE4	362	—	458	465	4	0.24	4.2	2.8	2.8	101
	580	190	5	3 600	6 600	370 000	670 000			362	—	558	499	4	0.31	3.2	2.1	2.1	206
360	540	134	4	2 390	4 700	244 000	480 000	TL23072CAME4 TL23976CAME4	TL23072CAMKE4 TL23976CAMKE4	382	—	518	485	4	0.24	4.2	2.8	2.8	106
	380	520	106	1 870	4 100	190 000	420 000			398	—	502	482	3	0.18	5.5	3.7	3.6	65.4
400	600	148	5	2 970	5 900	305 000	605 000	TL23080CAME4 TL23984CAME4	TL23080CAMKE4 TL23984CAMKE4	422	—	578	540	4	0.23	4.4	3.0	2.9	146
	420	560	106	1 870	4 250	191 000	430 000			438	—	542	521	3	0.17	6.0	4.0	3.9	71.6
440	650	157	6	3 150	6 350	320 000	645 000	TL23088CAME4 TL23992CAME4	TL23088CAMKE4 TL23992CAMKE4	468	—	622	587	5	0.23	4.3	2.9	2.8	173
	460	620	118	2 220	4 950	227 000	505 000			478	—	602	573	3	0.17	5.9	4.0	3.9	100
500	670	128	5	2 460	5 550	250 000	565 000	TL239/500CAME4	TL239/500CAMKE4	522	—	648	622	4	0.17	6.0	4.0	3.9	124

Note ⁽¹⁾ Suffix K indicates bearings with tapered bores (taper 1:12).

Remark Suffix E4 indicates bearings with oil groove and holes.

Air Turbine Dental Handpieces
 Pumps & Compressors
 Agricultural Machinery
 Construction Machinery
 Mining Machinery
 Railway Rolling Stock
 Papermaking Machines
 Wind Power Industry
 Steel Industry

Air Turbine Dental Handpieces
 Pumps & Compressors
 Agricultural Machinery
 Construction Machinery
 Mining Machinery
 Railway Rolling Stock
 Papermaking Machines
 Wind Power Industry
 Steel Industry

Molded-Oil™ Bearings

Bore Diameter 35 – 160 mm

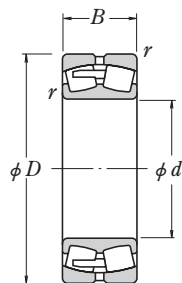

Cylindrical Bore

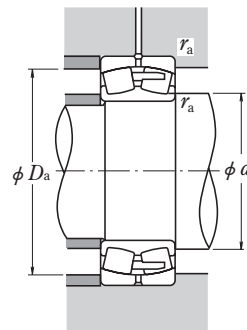

Dynamic Equivalent Load

$$P = XF_r + YF_a$$

$F_a/F_r \leq e$		$F_a/F_r > e$	
X	Y	X	Y
1	Y_3	0.67	Y_2

Static Equivalent Load

$$F_0 = F_r + Y_0 F_a$$

The values of e , Y_2 , Y_3 , and Y_0 are given in the table below.

Boundary Dimensions (mm)				Basic Load Ratings (kN) / (kgf)				Bearing Designation	Abutment and		Fillet Dimensions (mm)			Constant e	Axial Load Factors			Mass (kg) approx.
d	D	B	r min.	C_r	C_{0r}	C_r	C_{0r}		Cylindrical Bore		d_a min.	d_a max.	D_a max.		r_a min.	r_a max.	Y_2	
35	80	21	1.5	71	76	7 250	7 750	21307L12CAM	44	—	71	67	1.5	0.29	3.5	2.3	2.3	0.52
	90	23	1.5	82	93	8 350	9 500		21308L11ACAM	49	—	81	80	1.5	0.25	4.0	2.7	2.6
40	90	33	1.5	122	129	12 400	13 200	22308L11CAM	49	—	81	77	1.5	0.38	2.6	1.8	1.7	1.00
	85	23	1.1	778	88	7 950	9 000	22209L11CAM	52	—	78	75	1	0.28	3.6	2.4	2.4	0.57
45	100	36	1.5	148	167	15 100	17 100	22309L12CAM	54	—	91	85	1.5	0.36	2.8	1.9	1.8	1.24
	90	23	1.1	82	93	8 350	9 500	22210L11CAM	57	—	83	80	1	0.25	4.0	2.7	2.6	0.67
50	90	23	1.1	82	93	8 350	9 500	22210L11CAM	57	—	83	80	1	0.25	4.0	2.7	2.6	0.67
55	120	43	2	209	241	21 300	24 600	22311L12CAM	65	—	110	103	2	0.36	2.8	1.9	1.8	2.30
60	110	28	1.5	127	154	12 900	15 700	22212L12CAM	69	—	101	97	1.5	0.25	4.0	2.7	2.6	1.13
65	120	31	1.5	152	190	15 500	19 300	22213L11CAM	74	—	111	106	1.5	0.26	3.9	2.6	2.6	1.46
	140	48	2.1	265	315	27 000	32 500	22313L11CAM	77	—	128	117	2	0.35	2.9	1.9	1.9	3.56
	140	48	2.1	265	315	27 000	32 500	22313L12CAM	77	—	128	117	2	0.35	2.9	1.9	1.9	3.56
70	125	31	1.5	163	205	16 600	20 900	22214L11CAM	79	—	116	111	1.5	0.25	4.0	2.7	2.7	1.46
75	160	55	2.1	340	415	34 500	42 000	22315L12CAM	87	—	148	135	2	0.35	2.9	2.0	1.9	5.26
80	140	33	2	181	232	18 500	23 700	22216L11CAM	90	—	130	124	2	0.24	4.3	2.9	2.8	2.14
85	150	36	2	215	276	21 900	28 200	22217L12CAM	95	—	140	134	2	0.24	4.3	2.9	2.8	2.60
90	160	40	2	256	340	26 200	34 500	22218L12CAM	100	—	150	142	2	0.25	4.1	2.7	2.7	3.44
95	170	43	2.1	296	395	30 000	40 000	22219L12CAM	107	—	158	150	2	0.25	4.1	2.7	2.7	3.87
100	165	52	2	345	530	35 500	54 000	23120L11CAM	110	—	155	144	2	0.30	3.4	2.3	2.2	4.14
	215	73	3	600	785	61 500	80 000	22320L11CAM	114	—	201	183	2.5	0.35	2.9	1.9	1.9	12.7
110	200	53	2.1	425	585	43 500	59 500	22222L12CAM	122	—	188	176	2	0.24	4.2	2.8	2.7	7.23
120	180	46	2	315	525	32 000	53 500	23024L11CAM	130	—	170	163	2	0.22	4.5	3.0	2.9	4.15
	200	62	2	465	720	47 500	73 500	23124L12CAM	130	—	190	175	2	0.29	3.5	2.4	2.3	7.94
130	230	64	3	565	815	57 500	83 000	22226L11CAM	144	—	216	203	2.5	0.26	3.9	2.6	2.6	11.0
160	220	45	2	360	675	37 000	69 000	23932L11CAM	170	—	210	203	2	0.18	5.6	3.8	3.7	4.97

Remark Bearing designations other than those listed above may be available for production.

Air Turbine Dental Handpieces
 Pumps & Compressors
 Agricultural Machinery
 Construction Machinery
 Mining Machinery
 Railway Rolling Stock
 Papermaking Machines
 Wind Power Industry
 Steel Industry
 INDUSTRY SOLUTIONS

■ Triple Ring Bearings

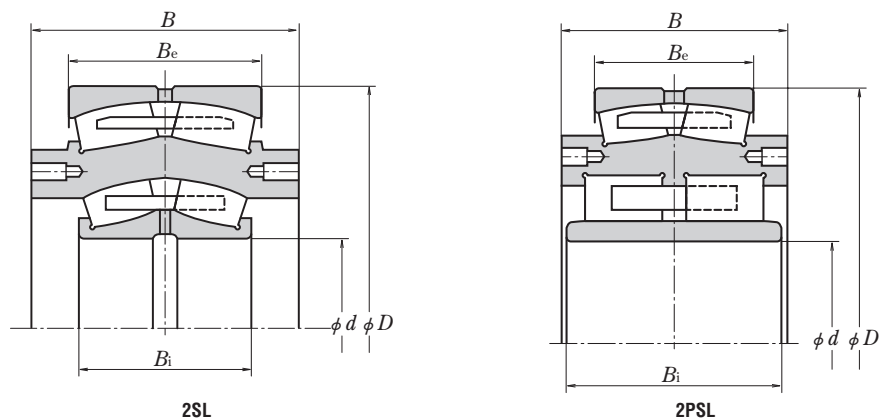

Bearing Designation	Boundary Dimensions (mm)					Mass (kg)
	d	D	B_i	B_e	B	
2SL180-2 UPA	180	480	140	160	215.9	175
2SL200-2 UPA	200	520	160	180	241.3	230
2SL220-2 UPA	220	600	180	200	279.4	330
2SL240-2 UPA	240	620	200	200	279.4	410
2SL260-2 UPA	260	680	218	218	317.5	490
2SL280-2 UPA	280	720	218	218	317.5	525
2SL300-2 UPA	300	780	243	250	342.9	735
2SL320-2 UPA	320	820	258	258	368.3	840
2SL340-2 UPA	340	870	280	272	393.7	1 050
2SL380-3 UPA	380	980	240	308	431.8	1 370
2PSL180-1 UPA	180	460	153	118	160	127
2PSL240-1 UPA	240	600	205	160	225	285

Air Turbine
Dental
Handpieces

Pumps &
Compressors

Agricultural
Machinery

Construction
Machinery

Mining
Machinery

Railway
Rolling Stock

Papermaking
Machines

Wind Power
Industry

Steel Industry

INDUSTRY
SOLUTIONS

Air Turbine
Dental
Handpieces

Pumps &
Compressors

Agricultural
Machinery

Construction
Machinery

Mining
Machinery

Railway
Rolling Stock

Papermaking
Machines

Wind Power
Industry

Steel Industry

INDUSTRY
SOLUTIONS

Bearings for the Wind Power Industry

High-performance, high-quality bearings offer long life for stable, low-maintenance operation.

Example Bearing Designations D 092



■ Bearings for the Wind Power Industry

Air Turbine
Dental
Handpieces

Pumps &
Compressors

Agricultural
Machinery

Construction
Machinery

Mining
Machinery

Railway
Rolling Stock

Papermaking
Machines

Wind Power
Industry

Steel Industry

INDUSTRY
SOLUTIONS

Air Turbine
Dental
Handpieces

Pumps &
Compressors

Agricultural
Machinery

Construction
Machinery

Mining
Machinery

Railway
Rolling Stock

Papermaking
Machines

Wind Power
Industry

Steel Industry

INDUSTRY
SOLUTIONS

Perspective View
of a Nacell

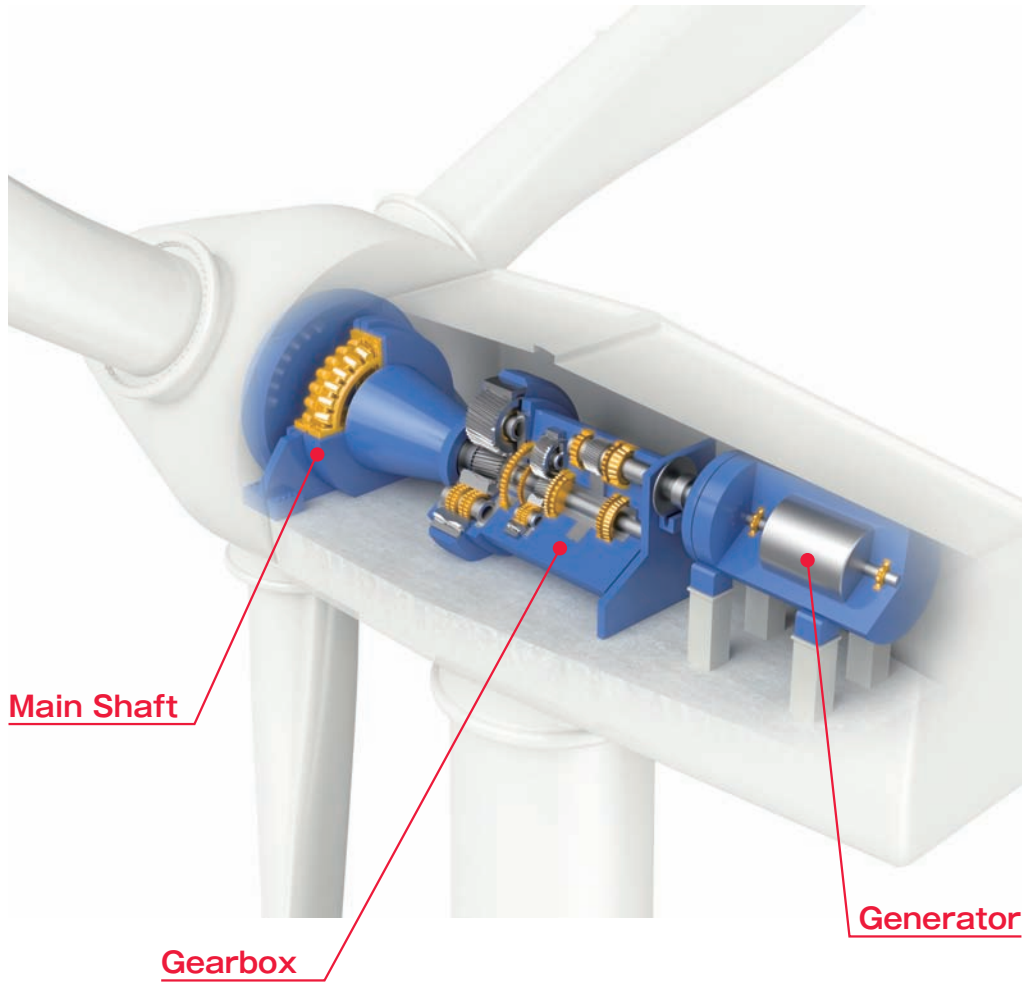

Perspective View
of a Gearbox

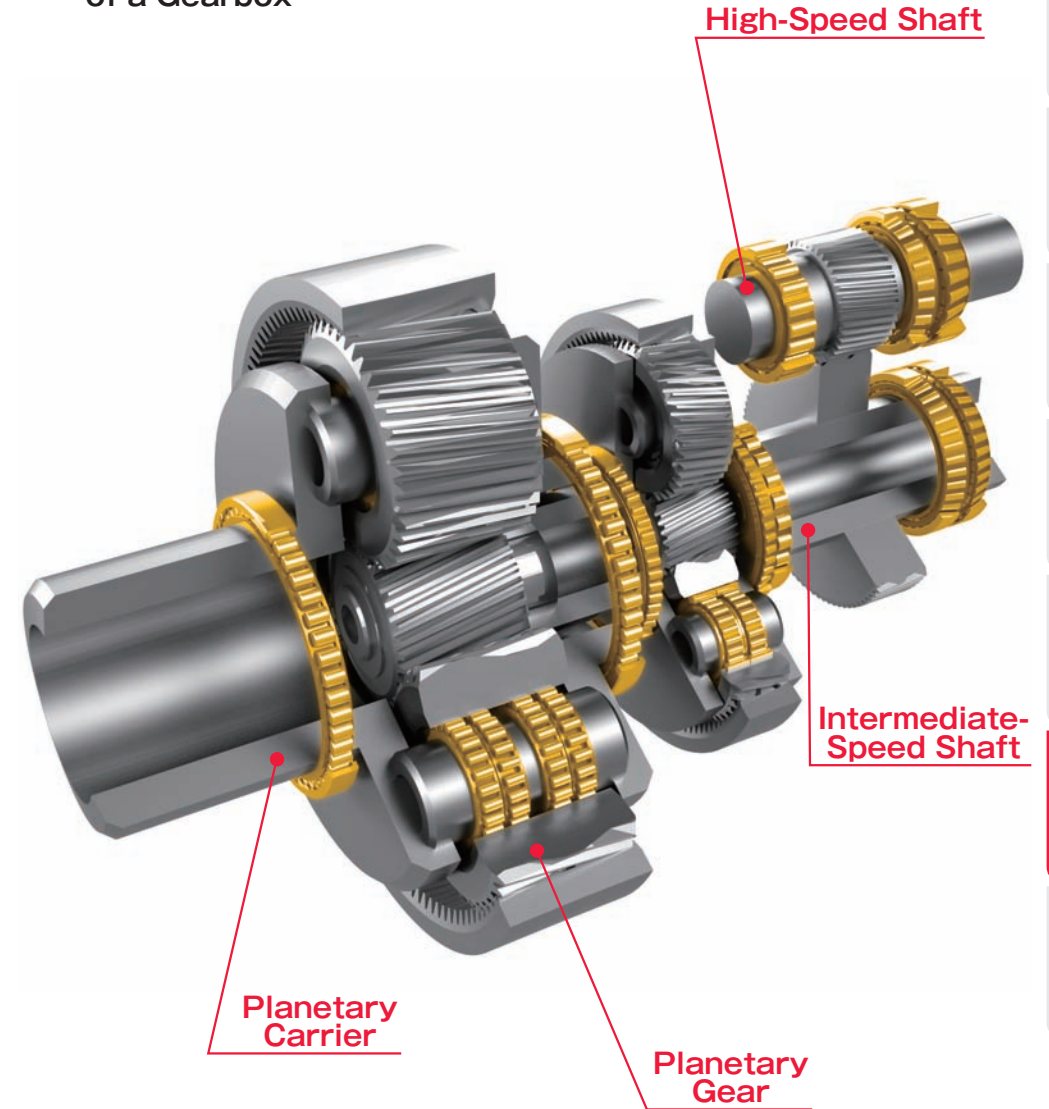

Main Shaft

Gearbox

Generator

High-Speed Shaft

Intermediate-Speed Shaft

Planetary Carrier

Planetary Gear

■ Bearings for the Wind Power Industry**Bearing Features****CA Series Spherical Roller Bearings**

CA Series double-row self-aligning spherical roller bearings feature a machined-brass cage and high load capacity, superior durability, and high resistance to wear. The CA Series is especially suitable for applications with heavy loads or shocks.

■ Applications: Main shafts

**NCF (Single-Row) and NNCF (Double-Row) Series Full Complement Cylindrical Roller Bearings**

Cageless full complement cylindrical roller bearings have the maximum possible number of rollers and can sustain much heavier loads than cylindrical roller bearings of the same size with cages.

■ Applications: Planetary carriers (NCF), Planetary gears (NNCF)

**XM Series High Load Capacity Cylindrical Roller Bearings**

By increasing the number of rollers, NSK has reduced the surface pressure exerted on the contact area between the rollers and rings, thereby increasing load capacity and extending the life of the bearing.

■ Applications: Gearboxes

**HR Series High-Load Capacity Tapered Roller Bearings**

HR Series tapered roller bearings are capable of taking combined heavy radial loads and axial loads in one direction.

The HR series features tapered rollers guided by larger rollers for superior high-load ratings.

■ Applications: Gearboxes

**Bearings With Black Oxide Coating**

These bearings feature a black oxide coating based on the DIN50938 standard to suppress white-structure flaking. Standard bearing steel, carburized steel, or original NSK materials (Super-TF™, AWS-TF™) can be used.

■ Applications: Gearboxes

**QJ Series Four-Point-Contact Ball Bearings**

The inner ring is split radially into two pieces. This design allows one bearing to sustain significant axial loads in either direction with high axial load capacity. This type is suitable for carrying pure axial loads or combined loads where axial load is high.

■ Applications: Gear Box intermediate-speed shafts, high-speed shafts

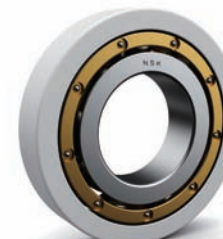
**Ceramic-Coated Insulated Bearings**

A layer of insulation is formed on the outer ring surface. The boundary dimensions are identical to a standard bearing, enabling easy replacement.

■ Applications: Generators

**Super-TF™ Bearings**

Super-TF bearings were developed with innovative materials and heat treatment technology for increased durability under harsh conditions.

They combine long service life with high resistance to wear and seizure to achieve outstanding cost performance even under contaminated lubrication conditions.

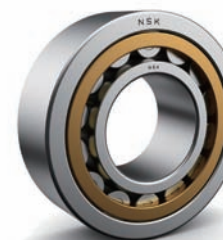
**AWS-TF™ Bearings**

AWS-TF bearings were developed with a combination of special heat treatment technology and materials. They provide excellent resistance to flaking, including white-structure flaking.

Example Bearing Designations

STF 240 /600 CA g M E4 U303

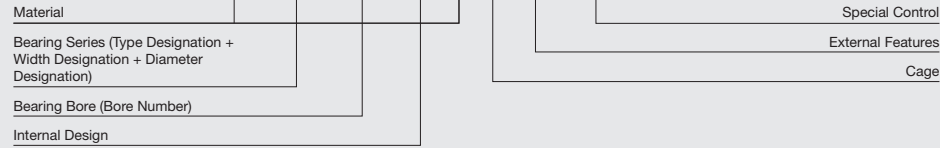

- 240 : Spherical Roller Bearing Width Series 4 Diameter Series 0
- /600 : Bearing Bore 600 mm
- CA : High-Capacity Design
- STF~g : Long-Life Steel
- M : Machined-Brass Cage
- E4 : Lubricating Groove in Outside Surface and Holes in Outer Ring
- U303 : Special Process Control for Wind Turbine Bearings

NNCF50 44 /S/ V DR U303

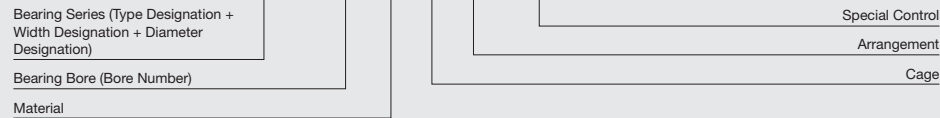

- NNCF50 : NNCF Full Complement Cylindrical Roller Bearing Width Series 5 Diameter Series 0
- 44 : Bearing Bore 220 mm
- /S/ : Black Oxide Coating
- V : Without Cage
- DR : Controlled Size Variation Arrangement
- U303 : Special Process Control for Wind Turbine Bearings

AWS NU23 26 E g XM U303

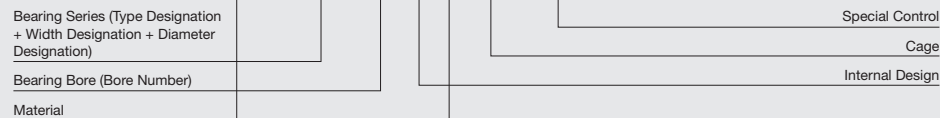

- NU23 : NU-Type Cylindrical Roller Bearing Width Series 2 Diameter Series 3
- 26 : Bearing Bore 130 mm
- E : High Capacity Design
- AWS~g : Long-Life Steel, Specialized to Prevent White-Structure Flaking
- XM : High-Capacity Machined-Brass Cage
- U303 : Special Process Control for Wind Turbine Bearings

HR 303 26 J /HR 313 26 J DF +KR U303



- HR/HR : High-Capacity Design
- 303/313 : Tapered Roller Bearing Width Series 0/1 Diameter Series 3
- 26/26 : Bearing Bore 130 mm
- J/J : Conforms to ISO
- DF : Face-to-Face Arrangement
- +KR : Bearings With Outer Ring Spacer
- U303 : Special Process Control for Wind Turbine Bearings

QJ3 28 M E U303

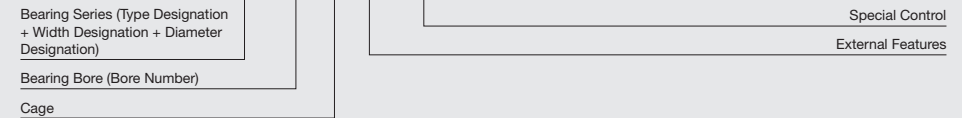

- QJ3 : Four-Point-Contact Ball Bearing Diameter Series 3
- 28 : Bearing Bore 140 mm
- M : Machined-Brass Cage
- E : Notch in Outer Ring
- U303 : Special Process Control for Wind Turbine Bearings

63 30 HDY2 MR X26 U303



- 63 : Single-Row Deep Groove Ball Bearing Diameter Series 3
- 30 : Bearing Bore 150 mm
- HDY2 : Ceramic-Insulated Coating on Outer Ring
- MR : Ball-Guided Machined-Brass Cage
- X26 : Dimensional Stabilizing Treatment
- U303 : Special Process Control for Wind Turbine Bearings

Bearings for the Steel Industry

High-performance bearings help maximize uptime and reduce maintenance costs.

(*1)



(*1)

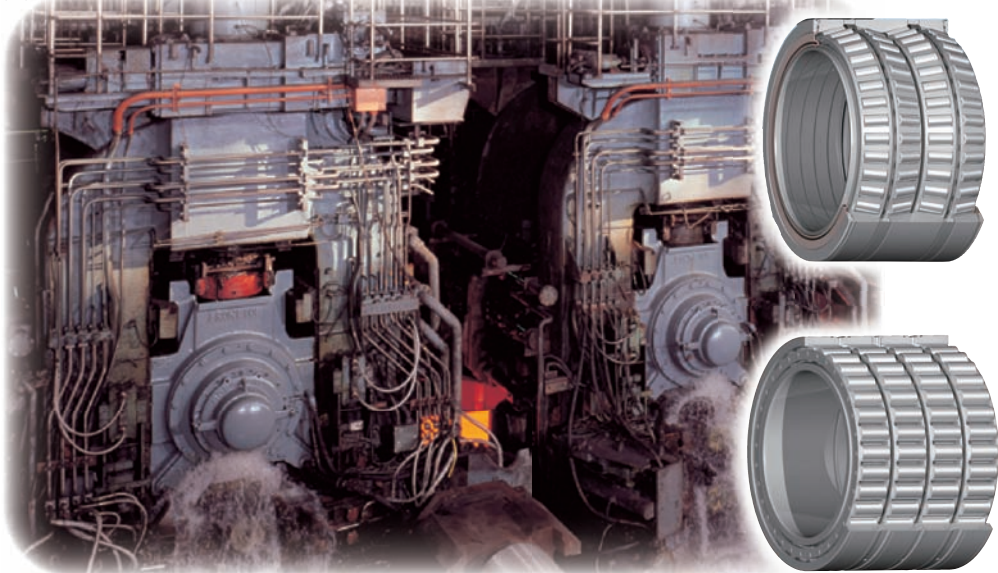

(*2)

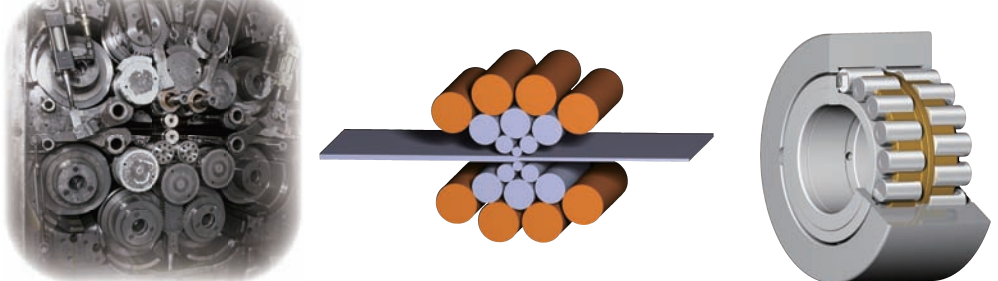

Bearings for Sintering Equipment D 098

AR Series Sealed-Clean Bearings for Pallet Wheels
-2J and 2M Series for Inboard Rollers

Bearings for BOFs and Converters D 102

Extra-Large Split Bearings for BOFs and Converter Trunnions

Bearings for Continuous Casting Machines D 106

SWR™ Bearings (Spherical Roller Bearings)
RUB Series Cylindrical Roller Bearings With Aligning Rings
(for Free End)

RNPH/PCR Series Split Cylindrical Roller Bearings
(for Segmented Rolls)

Bearings for Rolling Mills (for Roll Necks) D 128

KVS Series Extra-Capacity Sealed-Clean™
Four-Row Tapered Roller Bearings
Super-TF™ Bearings
Water-TF™ Bearings

STF-RV Series Four-Row Cylindrical Roller Bearings

Backing Bearings for Multi-Roll Rolling Cluster Mills D 166

Super-TF™ Backing Bearings

Notes (*1): Photo courtesy of NIPPON STEEL & SUMITOMO METAL CORPORATION KASHIMA WORKS.
(*2): Photo courtesy of Nippon Steel & Sumikin Stainless Steel Corporation.

A complete product line for all steel mill processes delivers improved productivity and lower maintenance costs thanks to highly reliable long-life bearings.

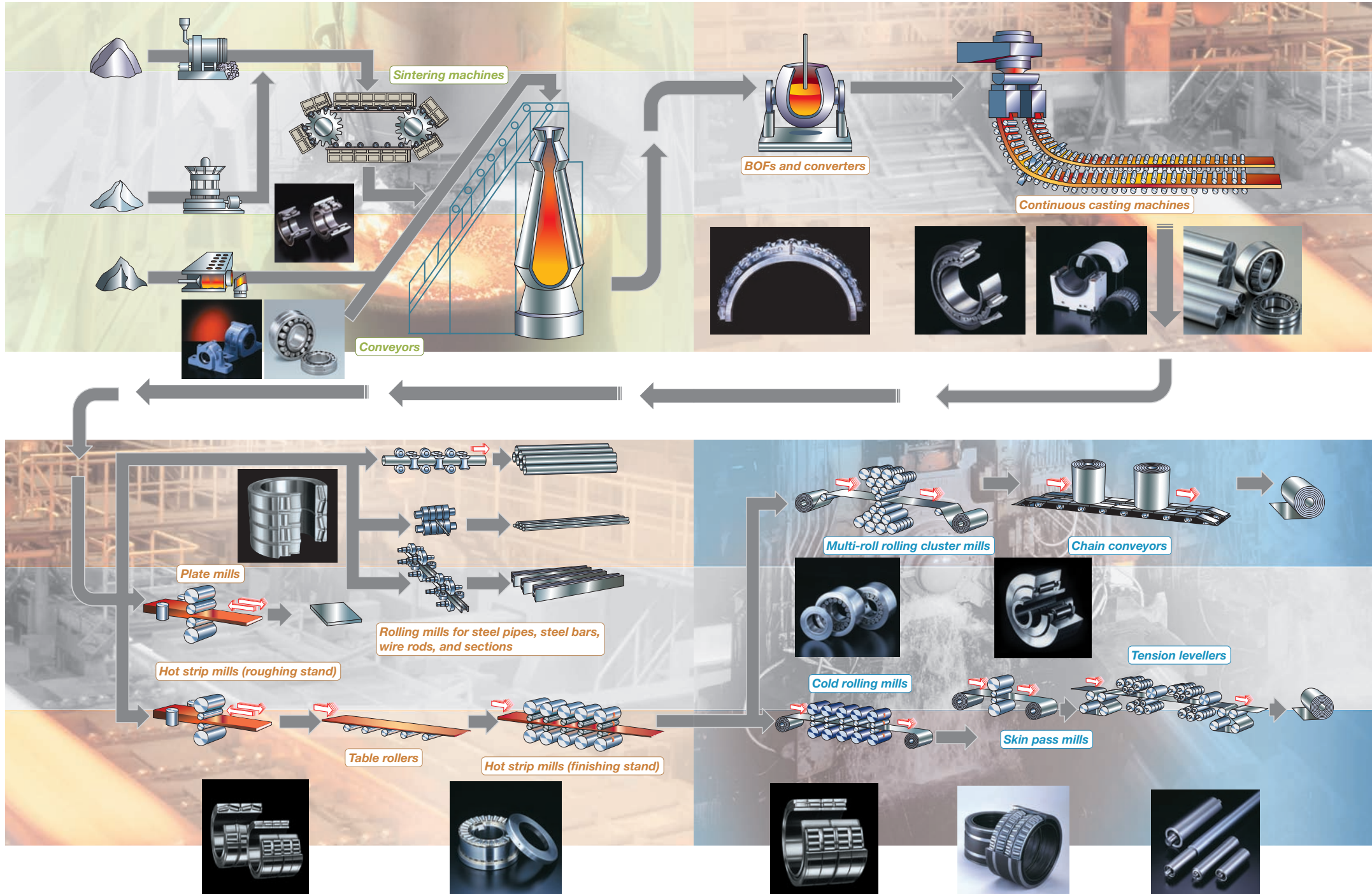

Air Turbine
Dental
Handpieces

Pumps &
Compressors

Agricultural
Machinery

Construction
Machinery

Mining
Machinery

Railway
Rolling Stock

Papermaking
Machines

Wind Power
Industry

Steel Industry

INDUSTRY
SOLUTIONS

Air Turbine
Dental
Handpieces

Pumps &
Compressors

Agricultural
Machinery

Construction
Machinery

Mining
Machinery

Railway
Rolling Stock

Papermaking
Machines

Wind Power
Industry

Steel Industry

INDUSTRY
SOLUTIONS

Bearings for Sintering Equipment

Sealed-Clean Bearings for Pallet Wheels / Sealed-Clean Bearings for Inboard Rollers

- Benefits**
- ① Stable machinery operation through higher reliability and longer operating life
 - ② Cleaner areas adjacent to equipment
 - ③ Lower maintenance costs

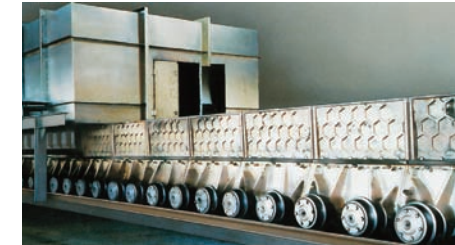

1. Operating conditions

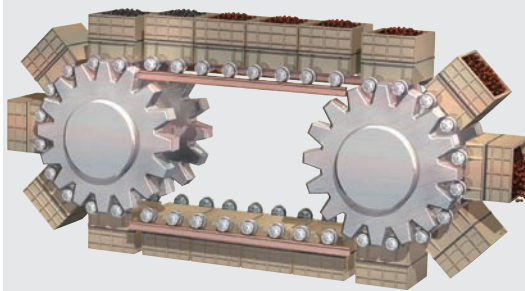
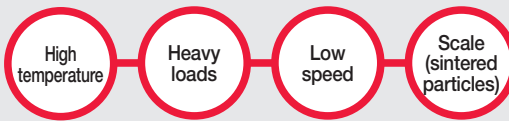

Sintering equipment

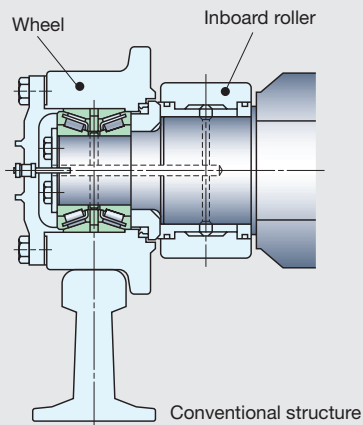

2. Problems

Typical problems with bearings for sintering equipment

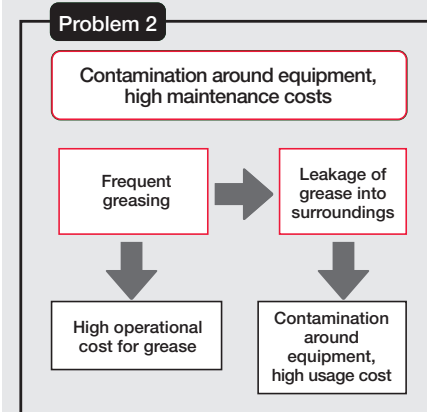
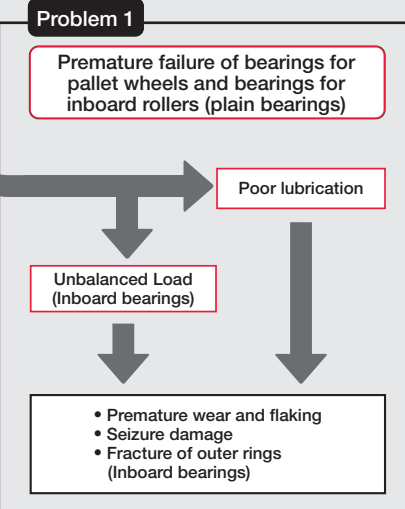

3. Countermeasures

- Features** AR-Series Sealed-Clean Bearings for Pallet Wheels
- Optimum crowning of the roller raceway surface enables resistance to unbalanced wheel load
 - High sealing performance (featuring a special contact seal)
 - Packed with grease featuring excellent heat and pressure resistance
 - Easier handling (one-piece design with fastening ring inner ring)

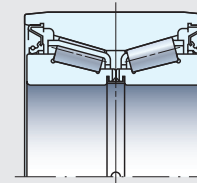

Designations Page D100

- Features** Sealed-Clean Bearings for Inboard Rollers-2J, 2M Series
- Higher load capacity (by outer ring thickness design with high strength and full-complement roller type)
 - Improvement of axial load capacity
 - High sealing performance (featuring a special contact seal)
 - Packing of grease with excellent heat and pressure resistance
 - Easier handling (one-piece design with fastening ring adopted for the inner ring)

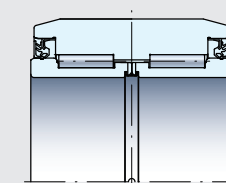

Designations Page D101

Durability Performance of Bearings in Field Test

	Comparison of actual life extension in field tests		
Conventional structure	1		
Newly developed structure	2.5 on average	3 at maximum	

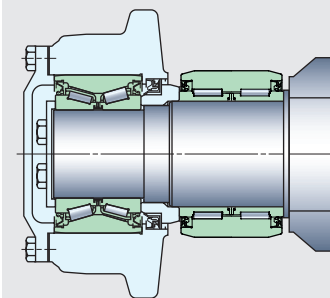

Newly developed structure

Estimated Reduction of Maintenance Costs

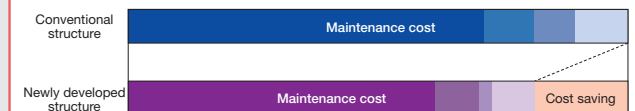

Maintenance costs include replacement costs for bearings, seals, and grease and operational costs associated with bearing replacement and greasing.

If bearing life with the newly developed structure is 2.5 times longer on average, the total reduction in maintenance costs is estimated to be 25 to 35 %.

Air Turbine Dental Handpieces
 Pumps & Compressors
 Agricultural Machinery
 Construction Machinery
 Mining Machinery
 Railway Rolling Stock
 Papermaking Machines
 Wind Power Industry
Steel Industry
 INDUSTRY SOLUTIONS

Air Turbine Dental Handpieces
 Pumps & Compressors
 Agricultural Machinery
 Construction Machinery
 Mining Machinery
 Railway Rolling Stock
 Papermaking Machines
 Wind Power Industry
Steel Industry
 INDUSTRY SOLUTIONS

Bearings for Sintering Equipment

AR Series Sealed-Clean Bearings for Pallet Wheels

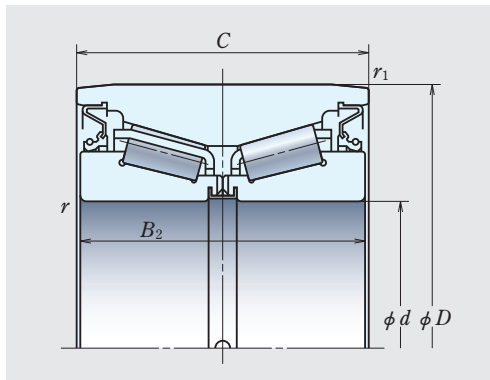

2J and 2M Series Sealed-Clean Bearings for Inboard Rollers

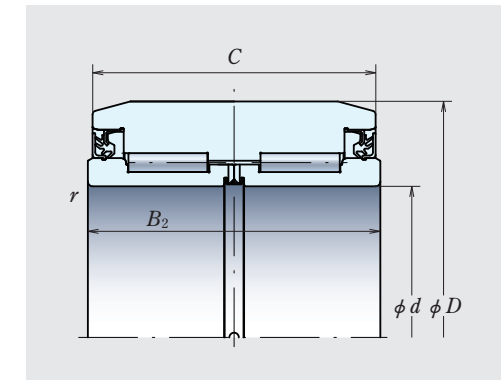
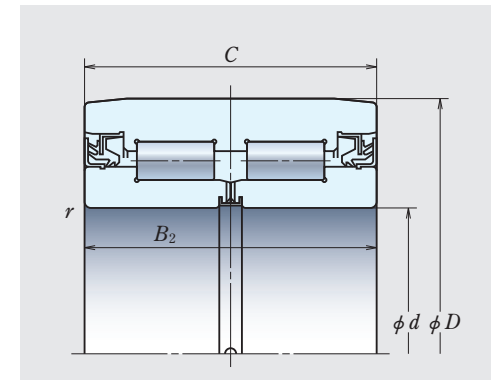

Fig. 1

Fig. 2

Bearing Designation	Boundary Dimensions (mm)						Basic Load Ratings (kN)	
	<i>d</i>	<i>D</i>	<i>B</i> ₂	<i>C</i>	<i>r</i> (min)	<i>r</i> ₁ (min)	<i>C</i> _r	<i>C</i> _{0r}
AR80-24	80	150	67	67	2.5	1	269	390
AR90-25	90	160	74	74	2.5	0.5	240	435
AR90-26	90	160	80	80	2.5	0.5	240	435
AR90-27	90	160	78	78	2.5	0.5	240	435
AR90-32A	90	160	100	100	2.5	—	440	850
AR100-29	100	180	98	100	2.5	1	350	675
AR100-30	100	180	100	100	2.5	1	350	675
AR100-38	100	180	100	100	3	0.5	525	835
AR100-39	100	180	98	100	3	0.5	525	835
AR100-40	100	180	98	100	3	0.5	525	835
AR100-44	100	180	91	91	3	0.5	435	665
AR110-28	110	180	86	86	3	0.5	330	660
AR110-29	110	200	92	100	2.5	1	415	805
AR110-39	110	200	100	100	3	1	570	950
AR110-50A	110	200	90	90	3	0.5	500	780

Remark Other bearings are available. Please contact NSK for additional information.

Bearing Designation	Boundary Dimensions (mm)					Basic Load Ratings (kN)		Fig.
	<i>d</i>	<i>D</i>	<i>B</i> ₂	<i>C</i>	<i>r</i> (min)	<i>C</i> _r	<i>C</i> _{0r}	
2J100-2	100	200	120	119	2.1	315	910	1
2J120-9A	120	210	120	120	2.5	610	1 080	1
2J120-14	120	210	132	132	2.1	530	1 320	1
2M120-17	120	210	132	132	2.1	425	1 390	2
2M140-(5)	140	250	116	110	2	395	1 030	2
2M140-()	140	250	130	130	4	485	1 460	2
2J140-2	140	250	130	130	4	770	1 420	1
2M150-()	150	320	120	120	5	615	1 350	2
2M158-3	158	250	140	140	5	570	1 850	2
2J160Z-1	160.11	250	130	130	2.5	670	1 540	1
2M160Z-13	160.11	250	150	150	2.5	595	1 980	2
2J160Z-5	160.11	250	155	150	2.1	610	2 050	1

Remark Other bearings are available. Please contact NSK for additional information.

Air Turbine
Dental
Handpieces

Pumps &
Compressors

Agricultural
Machinery

Construction
Machinery

Mining
Machinery

Railway
Rolling Stock

Papermaking
Machines

Wind Power
Industry

Steel Industry

INDUSTRY
SOLUTIONS

Air Turbine
Dental
Handpieces

Pumps &
Compressors

Agricultural
Machinery

Construction
Machinery

Mining
Machinery

Railway
Rolling Stock

Papermaking
Machines

Wind Power
Industry

Steel Industry

INDUSTRY
SOLUTIONS

Bearings for BOFs and Converters

Extra-Large Split Bearings for BOFs and Converter Trunnions

Benefits

- ❶ Bearings can be replaced without removing the bull gear, thus reducing maintenance costs
- ❷ Further reduced maintenance costs by shortening length of bearing replacement work
- ❸ Reduced production downtime, which affects subsequent processes

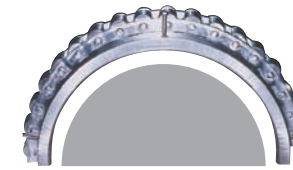

(*1)

1. Operating conditions

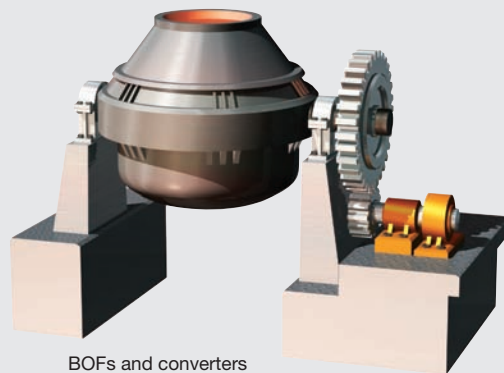

BOFs and converters

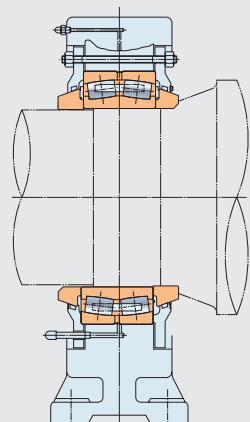

Conventional structure

2. Problems

Typical problems with bearings for BOFs and converters

Inboard bearings cannot be replaced without removing the bull gear

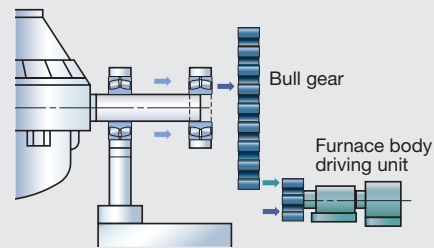

Bearing replacement work is time-consuming and requires expensive maintenance costs

Sudden bearing replacement due to unexpected failure causes large production losses in subsequent processes

3. Countermeasures

Features Extra-Large Split Bearings for BOFs and Converter Trunnions

- Split design: (1) outer ring, (2) inner ring, (3) roller and cage assembly, and (4) fastening ring
- Integrated seal sliding surface with a fastening ring

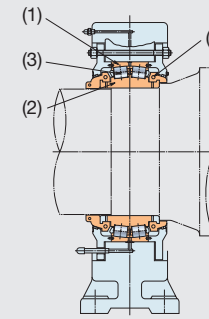

Newly developed structure

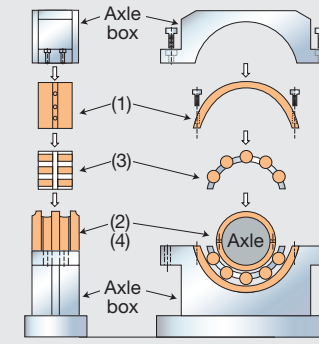
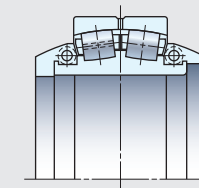
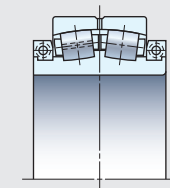

Image of bearing mounting

• Bearing Structure



Designations Pages D104 and D105

Reduction of Maintenance Costs

Comparison of time required for bearing replacement work

Bearing type	Comparison of time required for bearing replacement work in field test	
Conventional structure (one-piece type)	1	
Newly developed structure (split type)	0.65	0.35 ← Reduction

- The bearing replacement period reflects actual result for bearings with bore diameter of 1 200 mm to 1 400 mm.
- The bearing with the newly developed structure reduced the time needed for bearing replacement work by approximately 35 % and significantly reduced maintenance costs.

Note (*1): Photo courtesy of NIPPON STEEL & SUMITOMO METAL CORPORATION KASHIMA WORKS.

■ Bearings for BOFs and Converters

Extra-Large Split Bearings for BOFs and Converter Trunnions

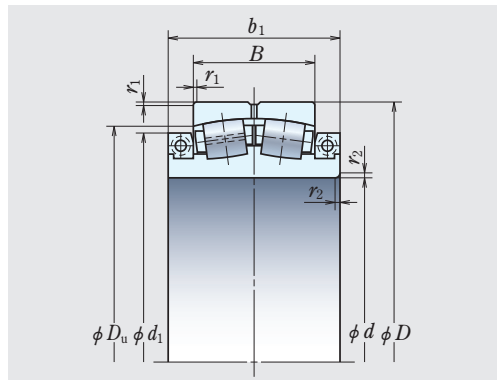

Fig. 1

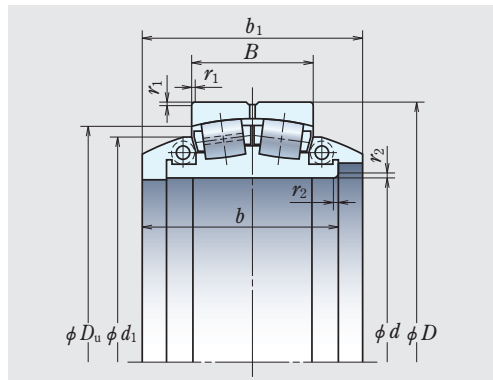

Fig. 2 Clamp Ring With Tangential Seal Surface

Bearing Designation	Boundary Dimensions (mm)									Basic Load Ratings (kN)		Fig.
	d	D	B	b	b_1	d_1	D_u	$r_1(\text{min})$	$r_2(\text{min})$	C_r	C_{0r}	
750SLPT1051	750	1 000	250	355	—	905	914.4	6	7.5	6 800	18 300	1
SL850-7	850	1 120	272	385	—	1 015	1 025	6	6	8 000	21 600	1
900SLPT1251	900	1 250	285	410	—	1 100	1 142	7.5	19	9 850	24 200	1
950SLPT1451	950	1 400	300	520	600	1 182	1 265	7.5	28	12 300	27 900	2
SL1120-3	1 120	1 580	320	632.5	697.5	1 400	1 445	9.5	30	13 200	32 000	2
1200SLPT1751	1 200	1 700	410	780	780	1 470	1 536	9.5	31	17 300	43 500	2
1200SLPT1752	1 200	1 700	410	660	730	1 470	1 536	9.5	19	17 300	43 500	2
1320SLPT1851	1 320	1 850	530	815	814	1 600	1 670	12	31	22 500	63 500	2
1400SLPT1951	1 400	1 900	530	880	880	1 680	1 710	12	31	22 800	65 000	2
1400SLPT1953	1 400	1 900	530	810	860	1 680	1 710	12	31	22 800	65 000	2

Remarks 1. The shapes of bearings marked with an asterisk * are not exactly the same as shown in Fig. 2.
 2. Other bearings are available. Please contact NSK for additional information.

Air Turbine
Dental
Handpieces

Pumps &
Compressors

Agricultural
Machinery

Construction
Machinery

Mining
Machinery

Railway
Rolling Stock

Papermaking
Machines

Wind Power
Industry

Steel Industry

INDUSTRY
SOLUTIONS

Air Turbine
Dental
Handpieces

Pumps &
Compressors

Agricultural
Machinery

Construction
Machinery

Mining
Machinery

Railway
Rolling Stock

Papermaking
Machines

Wind Power
Industry

Steel Industry

INDUSTRY
SOLUTIONS

Bearings for Continuous Casting Machines

Bearings for Guide Rolls

- Benefits**
- ① Improved bearing durability reduces unplanned downtime
 - ② Less frequent roll segment replacement reduces maintenance costs

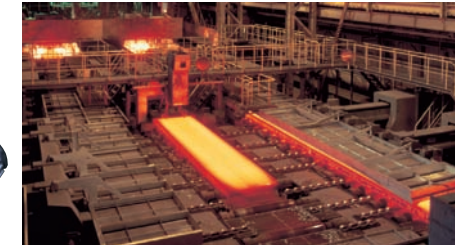

(*1)

1. Operating conditions

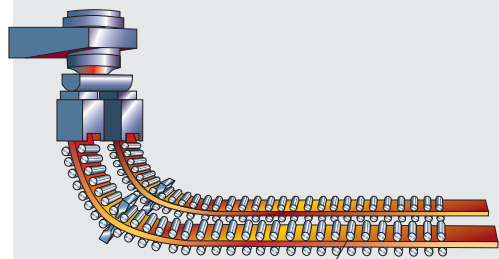
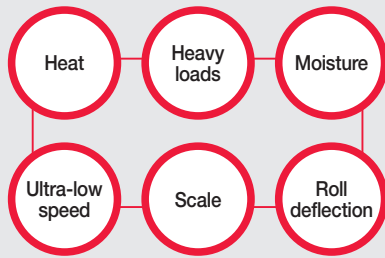

Continuous casting machine

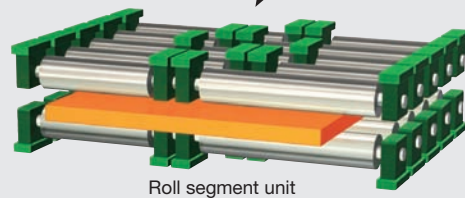

Roll segment unit

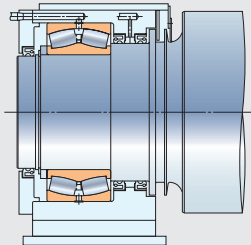

Axle box structure

2. Problems

Typical problems with bearings for continuous casting machines

Differential sliding specific to spherical roller bearings

Uneven wear

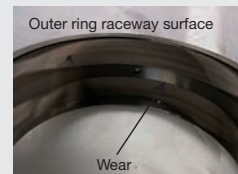

Outer ring raceway surface
Wear

Flaking

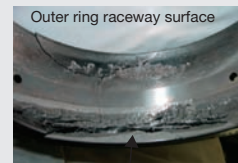

Outer ring raceway surface
Flaking and cracking

Crack

- Expansion of roll gaps (failure of rolls)
- Decline in product quality
- Unexpected downtime
- High bearing usage cost

3. Countermeasures

Features SWR™ Bearings (Spherical Roller Bearings)

- Improved wear resistance → Three times higher than AISI 52100 bearing steel
- Improved flaking life → Five times higher than AISI 52100 bearing steel
- Improved toughness of material core (prevention of cracks) → Five times stronger than AISI 52100 bearing steel

Designations Pages D108 to D115

SWR Bearing CAT.No.E1242



Microstructure (TEM)

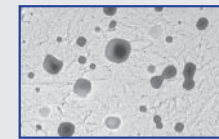

SUJ2 1μm

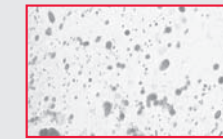

SWR 1μm

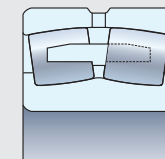

SWR

Features RUB Series Cylindrical Roller Bearings With Aligning Rings (for Free End)

- Cylindrical roller bearings with self-aligning capabilities prevent internal wear problems caused by sliding
- Smooth relief of roll expansion
- Available in easy-to-handle cage and higher load capacity full complement types

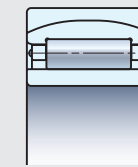

RUB (with cage)

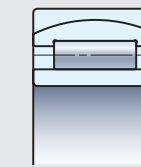

RUB (full complement)

Designations Pages D116 to D123

Features RNPH/PCR Series Split Cylindrical Roller Bearings (for Segmented Rolls)

- Cylindrical roller bearings with self-aligning capabilities prevent wear problems caused by sliding
- Full-complement, higher load capacity design
- Multi-functional seal and high-rigidity plummer block unit

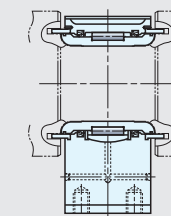

RNPH/PCR

Designations Pages D124 to D127

Note (*1): Photo courtesy of NIPPON STEEL & SUMITOMO METAL CORPORATION KASHIMA WORKS.

Air Turbine Dental Handpieces
 Pumps & Compressors
 Agricultural Machinery
 Construction Machinery
 Mining Machinery
 Railway Rolling Stock
 Papermaking Machines
 Wind Power Industry
Steel Industry
 INDUSTRY SOLUTIONS

Air Turbine Dental Handpieces
 Pumps & Compressors
 Agricultural Machinery
 Construction Machinery
 Mining Machinery
 Railway Rolling Stock
 Papermaking Machines
 Wind Power Industry
Steel Industry
 INDUSTRY SOLUTIONS

■ Bearings for Continuous Casting Machines

SWR™ Bearings (Spherical Roller Bearings)
Bore Diameter 40 – 100 mm

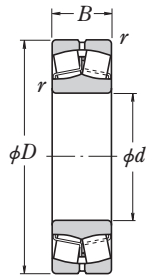

EA



C, CD



CA

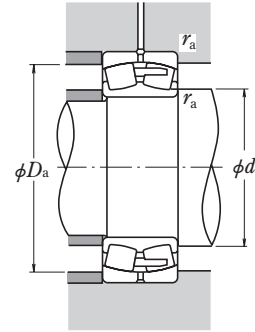

Dynamic Equivalent Load

$$P = X F_r + Y F_a$$

$F_a/F_r \leq e$		$F_a/F_r > e$	
X	Y	X	Y
1	Y_3	0.67	Y_2

Static Equivalent Load

$$F_0 = F_r + Y_0 F_a$$

The values of e , Y_2 , Y_3 , and Y_0 are given in the table below.

Boundary Dimensions (mm)				Basic Load Ratings				Bearing Designation	Abutment and Fillet Dimensions (mm)			Constant	Axial Load Factors			Mass (kg)		
d	D	B	r min.	C_r (kN)	C_{0r} (kgf)	C_r (kgf)	C_{0r} (kgf)		d_a min. max.	D_a max. min.	r_a max.		e	Y_2	Y_3		Y_0	approx.
40	80	23	1.1	90.5	99.5	9 200	10 100	22208SWREAE4	47	49	73	70	1	0.28	3.6	2.4	2.4	0.5
	90	33	1.5	136	153	13 900	15 600	22308SWRCAME4	49	—	81	77	1.5	0.38	2.6	1.8	1.7	1.0
50	90	23	1.1	99	119	10 100	12 100	22210SWREAE4	57	60	83	81	1	0.24	4.3	2.9	2.8	0.61
	120	29	2	119	144	12 100	14 600	22211SWREAE4	64	65	91	89	1.5	0.23	4.3	2.9	2.8	0.81
55	100	25	1.5	142	174	14 500	17 800	21311SWREAE4	65	72	110	98	2	0.23	4.4	3.0	2.9	1.58
	110	28	1.5	98.5	141	10 000	14 400	23012SWRCCE4	67	68	88	85	1	0.26	3.9	2.6	2.5	0.68
60	110	28	1.5	142	174	14 500	17 800	22212SWREAE4	69	72	101	98	1.5	0.23	4.4	3.0	2.9	1.1
	110	28	1.5	178	154	18 100	15 700	22212SWRCAME4	69	—	101	97	1.5	0.25	4.0	2.7	2.6	1.17
65	130	31	2.1	190	244	19 400	24 900	21312SWREAE4	72	87	118	117	2	0.22	4.5	3.0	3.0	1.98
	130	46	2.1	246	288	25 100	29 400	22312SWRCAME4	72	—	118	111	2	0.36	2.8	1.9	1.9	2.9
70	120	31	1.5	152	190	15 500	19 300	22213SWRCAME4	74	—	111	106	1.5	0.26	3.9	2.6	2.6	1.57
	140	48	2.1	265	315	27 000	32 500	22313SWRCAME4	77	—	128	117	2	0.35	2.9	1.9	1.9	3.56
75	125	31	1.5	225	232	22 900	23 600	22214SWREAE4	79	84	116	111	1.5	0.23	4.3	2.9	2.8	1.58
	125	31	1.5	163	205	16 600	20 900	22214SWRCAME4	79	—	116	111	1.5	0.25	4.0	2.7	2.7	1.64
80	130	31	1.5	238	244	24 200	24 900	22215SWREAE4	84	87	121	117	1.5	0.22	4.5	3.0	3.0	1.64
	140	33	2	264	275	27 000	28 000	22216SWREAE4	90	94	130	126	2	0.22	4.6	3.1	3.0	2.01
85	170	39	2.1	355	375	36 000	38 000	21316SWREAE4	92	109	158	146	2	0.23	4.4	3.0	2.9	4.32
	170	58	2.1	390	480	39 500	48 500	22316SWRCAME4	92	—	158	145	2	0.35	2.9	2.0	1.9	6.2
90	150	36	2	310	325	320	33 500	22217SWREAE4	95	101	140	135	2	0.22	4.6	3.1	3.0	2.54
	160	40	2	360	395	37 000	40 000	22218SWREAE4	100	108	150	142	2	0.24	4.3	2.9	2.8	3.3
95	160	52.4	2	340	490	34 500	50 000	23218SWRCCE4	100	105	150	138	2	0.32	3.2	2.1	2.1	4.51
	190	64	3	665	705	68 000	72 000	22318SWREAE4	104	115	176	163	2.5	0.33	3.1	2.1	2.0	8.56
100	170	43	2.1	296	395	30 000	40 000	22219SWRCAME4	107	—	158	150	2	0.25	4.1	2.7	2.7	4.19
	150	37	1.5	212	335	21 600	34 500	23020SWRCDE4	109	112	141	136	1.5	0.22	4.6	3.1	3.0	2.31
100	150	50	1.5	276	470	28 100	48 000	24020SWRCCE4	109	110	141	132	1.5	0.30	3.4	2.3	2.2	3.08
	165	65	2	345	535	35 500	54 000	24120SWRCAME4	110	113	155	144	2	0.30	3.4	2.3	2.2	4.38
	165	65	2	345	535	35 500	54 000	24120SWRCAME4	110	113	155	144	2	0.30	3.4	2.3	2.2	4.38
	180	46	2.1	455	490	46 500	50 000	22220SWREAE4	112	119	168	160	2	0.24	4.3	2.9	2.8	4.84

Air Turbine Dental Handpieces
 Pumps & Compressors
 Agricultural Machinery
 Construction Machinery
 Mining Machinery
 Railway Rolling Stock
 Papermaking Machines
 Wind Power Industry
Steel Industry
 INDUSTRIAL SOLUTIONS

■ Bearings for Continuous Casting Machines

SWR™ Bearings (Spherical Roller Bearings)
Bore Diameter 110 – 140 mm

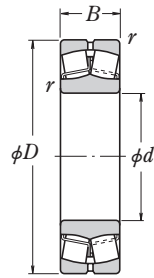

EA



C, CD



CA

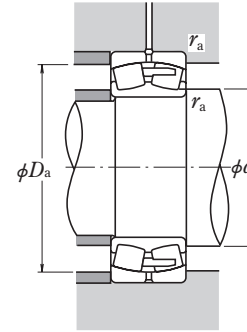

Dynamic Equivalent Load

$$P = X F_r + Y F_a$$

$F_a/F_r \leq e$		$F_a/F_r > e$	
X	Y	X	Y
1	Y_3	0.67	Y_2

Static Equivalent Load

$$P_0 = F_r + Y_0 F_a$$

The values of e , Y_2 , Y_3 , and Y_0 are given in the table below.

Boundary Dimensions (mm)				Basic Load Ratings				Bearing Designation	Abutment and Fillet Dimensions (mm)			Constant e	Axial Load Factors			Mass (kg) approx.			
d	D	B	r min.	C_r (kN)	C_{0r} (kgf)	C_r (kgf)	C_{0r} (kgf)		d_a min.	d_a max.	D_a max.		D_a min.	r_a max.	Y_2		Y_3	Y_0	
110	170	45	2	293	465	29 900	47 500	23022SWRCDE4	120	124	160	153	2	0.24	4.2	2.8	2.8	3.76	
	170	45	2	293	465	30 900	47 500	23022SWRCAME4	120	—	160	153	2	0.24	4.2	2.8	2.8	3.74	
	170	60	2	380	645	38 500	66 000	24022SWRCDE4	120	121	160	148	2	0.32	3.1	2.1	2.1	4.96	
	180	56	2	480	630	49 000	64 000	23122SWRCAME4	120	—	170	158	2	0.28	3.5	2.4	2.3	5.67	
	180	69	2	460	750	47 000	76 500	24122SWRCDE4	120	123	170	154	2	0.36	2.8	1.9	1.8	6.84	
	200	53	2.1	605	645	61 500	66 000	22222SWREAE4	122	129	188	178	2	0.25	4.0	2.7	2.6	6.99	
	200	53	2.1	425	585	43 500	59 500	22222SWRCAME4	122	—	188	176	2	0.24	4.2	2.8	2.7	7.26	
	200	69.8	2.1	645	760	65 000	77 500	23222SWRCAME4	122	—	188	170	2	0.34	3.0	2.0	1.9	9.58	
	240	80	3	1030	1120	10 500	115 000	22322SWREAE4	124	145	226	206	2.5	0.33	3.1	2.1	2.0	17.6	
	120	180	46	2	315	525	32 000	53 500	23024SWRCDE4	130	134	170	163	2	0.22	4.5	3.0	2.9	4.11
180		46	2	395	525	40 000	53 500	23024SWRCAME4	130	—	170	163	2	0.22	4.5	3.0	2.9	4.11	
180		60	2	395	705	40 500	72 000	24024SWRCDE4	130	131	170	158	2	0.32	3.2	2.1	2.1	5.33	
180		60	2	480	680	49 000	69 000	24024SWRCAME4	130	131	170	158	2	0.32	3.2	2.1	2.1	5.33	
200		80	2	575	950	58 500	96 500	24124SWRCDE4	130	136	190	171	2	0.37	2.7	1.8	1.8	10	
200		80	2	695	905	70 500	92 000	24124SWRCAME4	130	—	190	171	2	0.37	2.7	1.8	1.8	9.86	
215		58	2.1	490	690	50 000	70 000	22224SWRCAME4	132	—	203	189	2	0.25	4.1	2.7	2.7	9.05	
215		76	2.1	790	970	80 500	99 000	23224SWRCAME4	132	—	203	182	2	0.34	2.9	2.0	1.9	12	
260		86	3	845	1 120	80 600	115 000	22324SWRCAME4	134	—	246	219	2.5	0.35	2.9	2.0	1.9	22.3	
130		200	52	2	400	655	40 500	67 000	23026SWRCDE4	140	147	190	180	2	0.23	4.3	2.9	2.9	5.98
	200	69	2	495	865	50 500	88 000	24026SWRCDE4	140	143	190	175	2	0.31	3.2	2.2	2.1	7.84	
	200	69	2	620	865	60 300	88 000	24026SWRCAME4	140	—	190	175	2	0.31	3.2	2.2	2.1	7.83	
	210	80	2	590	1 010	60 000	103 000	24126SWRCDE4	140	146	200	180	2	0.35	2.9	1.9	1.9	10.7	
	210	80	2	590	1 010	60 000	103 000	24126SWRCAME4	140	—	200	180	2	0.37	2.7	1.8	1.8	10.6	
	230	64	3	820	940	83 500	96 000	22226SWREAE4	144	152	216	204	2.5	0.26	3.8	2.6	2.5	11	
	230	64	3	565	815	57 500	83 000	22226SWRCAME4	144	—	216	203	2.5	0.26	3.9	2.6	2.6	11.3	
	230	80	3	875	1 080	89 500	110 000	23226SWRCAME4	144	—	216	196	2.5	0.34	2.9	2.0	1.9	14.3	
	140	210	53	2	420	715	43 000	73 000	23028SWRCDE4	150	157	200	190	2	0.22	4.5	3.0	2.9	6.49
		210	69	2	525	945	53 500	96 500	24028SWRCDE4	150	154	200	186	2	0.29	3.4	2.3	2.2	8.37
210		69	2	635	905	64 500	92 500	24028SWRCAME4	150	—	200	186	2	0.31	3.2	2.2	2.1	8.32	

Air Turbine Dental Handpieces
 Pumps & Compressors
 Agricultural Machinery
 Construction Machinery
 Mining Machinery
 Railway Rolling Stock
 Papermaking Machines
 Wind Power Industry
 Steel Industry
 INDUSTRIAL SOLUTIONS

■ Bearings for Continuous Casting Machines

SWR™ Bearings (Spherical Roller Bearings)
Bore Diameter 140 – 180 mm

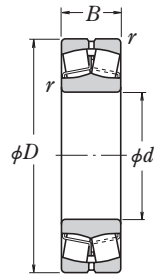

EA



C, CD



CA

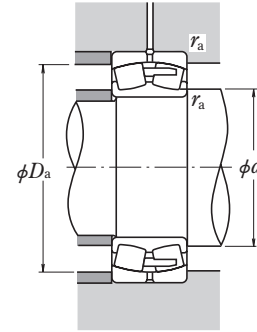

Dynamic Equivalent Load

$$P = XF_r + YF_a$$

$F_a/F_r \leq e$		$F_a/F_r > e$	
X	Y	X	Y
1	Y_3	0.67	Y_2

Static Equivalent Load

$$P_0 = F_r + Y_0 F_a$$

The values of e , Y_2 , Y_3 , and Y_0 are given in the table below.

Boundary Dimensions (mm)				Basic Load Ratings				Bearing Designation	Abutment		and Fillet Dimensions (mm)			Constant e	Axial Load Factors			Mass (kg) approx.	
d	D	B	r min.	C_r (kN)	C_{0r} (kgf)	C_r (kgf)	C_{0r} (kgf)		d_a min.	d_a max.	D_a max.	D_a min.	r_a max.		Y_2	Y_3	Y_0		
140	225	68	2.1	725	945	73 500	96 500	23128SWRCAME4	152	—	213	198	2	0.28	3.6	2.4	2.3	10.5	
	225	85	2.1	670	1 160	68 500	118 000	24128SWRCE4	152	156	213	193	2	0.35	2.9	1.9	1.9	13	
	225	85	2.1	835	1 160	85 500	118 000	24128SWRCAME4	152	—	213	192	2	0.37	2.7	1.8	1.8	12.9	
	250	68	3	645	930	65 500	95 000	22228SWRCDE4	154	167	236	219	2.5	0.25	4.0	2.7	2.6	14.5	
	250	68	3	835	945	85 500	96 500	22228SWRCAME4	154	—	236	221	2.5	0.26	3.9	2.6	2.5	14.2	
	250	88	3	835	1 300	85 000	133 000	23228SWRCAME4	154	—	236	213	2.5	0.35	2.9	2.0	1.9	18.8	
	150	225	56	2.1	470	815	48 000	83 000	23030SWRCDE4	162	168	213	203	2	0.22	4.6	3.1	3.0	7.9
		225	75	2.1	590	1 090	60 500	111 000	24030SWRCE4	162	165	213	198	2	0.30	3.4	2.3	2.2	10.5
		225	75	2.1	740	1 090	75 500	111 000	24030SWRCAME4	162	—	213	198	2	0.30	3.4	2.3	2.2	10.4
250		80	2.1	725	1 180	74 000	121 000	23130SWRCE4	162	174	238	218	2	0.30	3.4	2.3	2.2	15.8	
250		100	2.1	890	1 530	91 000	156 000	24130SWRCE4	162	169	238	212	2	0.38	2.6	1.8	1.7	19.8	
270		73	3	765	1 120	78 000	114 000	22230SWRCDE4	164	179	256	236	2.5	0.26	3.9	2.6	2.5	18.4	
270		96	3	975	1 560	99 500	159 000	23230SWRCE4	164	176	256	230	2.5	0.35	2.9	1.9	1.9	24.2	
160		240	60	2.1	540	955	55 000	97 500	23032SWRCDE4	172	179	228	216	2	0.22	4.5	3.0	2.9	9.66
		240	80	2.1	680	1 260	69 000	128 000	24032SWRCE4	172	177	228	212	2	0.30	3.4	2.3	2.2	12.7
	240	80	2.1	845	1 260	86 500	128 000	24032SWRCAME4	172	—	228	212	2	0.30	3.4	2.3	2.2	12.3	
	270	109	2.1	1 040	1 760	106 000	179 000	24132SWRCE4	172	179	258	229	2	0.39	2.6	1.7	1.7	25.4	
	290	80	3	910	1 320	93 000	135 000	22232SWRCDE4	174	190	276	255	2.5	0.26	3.8	2.6	2.5	23.1	
	290	80	3	1 140	1 320	116 000	135 000	22232SWRCAME4	174	—	276	255	2.5	0.26	3.8	2.6	2.5	23.1	
	170	260	67	2.1	640	1 090	65 000	112 000	23034SWRCDE4	182	191	248	233	2	0.23	4.3	2.9	2.8	13
		260	90	2.1	825	1 520	84 000	155 000	24034SWRCE4	182	188	248	228	2	0.31	3.2	2.2	2.1	17.3
		280	88	2.1	940	1 570	96 000	160 000	23134SWRCAME4	182	—	268	245	2	0.29	3.5	2.3	2.3	21.6
280		109	2.1	1 080	1 860	110 000	190 000	24134SWRCE4	182	190	268	239	2	0.37	2.7	1.8	1.8	26.6	
310		86	4	990	1 500	101 000	153 000	22234SWRCDE4	188	206	292	270	3	0.26	3.8	2.6	2.5	28.8	
310		110	4	1 200	1 910	122 000	195 000	23234SWRCE4	188	201	292	261	3	0.34	2.9	2.0	1.9	36.4	
180		280	74	2.1	750	1 270	76 000	129 000	23036SWRCDE4	192	202	26	249	2	0.24	4.2	2.8	2.8	17.1
		280	100	2.1	965	1 750	98 500	178 000	24036SWRCE4	192	200	268	245	2	0.32	3.1	2.1	2.0	22.7
		280	100	2.1	1 210	1 750	123 000	178 000	24036SWRCAME4	192	—	268	245	2	0.32	3.1	2.1	2.0	22.5
	300	96	3	1 320	1 760	134 000	180 000	23136SWRCAME4	194	—	286	260	2.5	0.31	3.3	2.2	2.2	27.4	
	300	118	3	1 190	2 040	121 000	208 000	24136SWRCE4	194	202	286	255	2.5	0.37	2.7	1.8	1.8	33.1	
	300	118	3	1 490	2 040	152 000	208 000	24136SWRCAME4	194	—	286	255	2.5	0.37	2.7	1.8	1.8	33	
	320	86	4	1 020	1 540	104 000	157 000	22236SWRCDE4	198	212	302	278	3	0.26	3.9	2.6	2.6	30.2	

Air Turbine Dental Handpieces
 Pumps & Compressors
 Agricultural Machinery
 Construction Machinery
 Mining Machinery
 Railway Rolling Stock
 Papermaking Machines
 Wind Power Industry
Steel Industry
 INDUSTRIAL SOLUTIONS

■ Bearings for Continuous Casting Machines

SWR™ Bearings (Spherical Roller Bearings)
Bore Diameter 190 – 240 mm

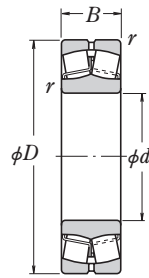

EA



C, CD



CA

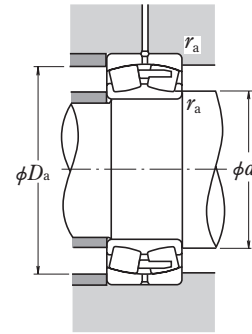

Dynamic Equivalent Load

$$P = X F_r + Y F_a$$

$F_a/F_r \leq e$		$F_a/F_r > e$	
X	Y	X	Y
1	Y_3	0.67	Y_2

Static Equivalent Load

$$P_0 = F_r + Y_0 F_a$$

The values of e , Y_2 , Y_3 , and Y_0 are given in the table below.

Boundary Dimensions (mm)				Basic Load Ratings				Bearing Designation	Abutment and Fillet Dimensions (mm)			Constant e	Axial Load Factors			Mass (kg) approx.			
d	D	B	r min.	C_r (kN)	C_{0r} (kN)	C_r (kgf)	C_{0r} (kgf)		d_a min.	d_a max.	D_a max.		r_a min.	r_a max.	Y_2		Y_3	Y_0	
190	290	75	2.1	970	1 350	99 000	138 000	23038SWRCAME4	202	—	278	261	2	0.24	4.2	2.8	2.8	17.6	
	290	100	2.1	975	1 840	99 500	188 000	24038SWRCE4	202	210	278	253	2	0.31	3.2	3.2	2.1	24	
	290	100	2.1	1 220	1 840	124 000	188 000	24038SWRCAME4	202	—	278	253	2	0.32	3.1	2.1	2.0	23.8	
	320	128	3	1 370	2 330	140 000	238 000	24138SWRCE4	204	211	306	269	2.5	0.4	2.5	1.7	1.6	41.5	
	320	128	3	1 710	2 330	175 000	238 000	24138SWRCAME4	204	—	306	269	2.5	0.38	2.6	1.8	1.7	40.9	
	340	92	4	1 140	1 730	116 000	176 000	22238SWRCAME4	208	—	322	296	3	0.26	3.8	2.6	2.5	35.5	
	340	120	4	1 440	2 350	147 000	240 000	23238SWRCE4	208	222	322	288	3	0.35	2.9	1.9	1.9	47.6	
	200	310	82	2.1	1 180	1 700	120 000	174 000	23040SWRCAME4	212	—	298	279	2	0.25	4.0	2.7	2.6	22.6
		310	109	2.1	1 140	2 120	116 000	216 000	24040SWRCE4	212	223	298	271	2	0.32	3.1	2.1	2.0	30.4
310		109	2.1	1 420	2 120	145 000	216 000	24040SWRCAME4	212	—	298	271	2	0.33	3.0	2.0	2.0	30.2	
340		140	3	1 570	2 670	160 000	272 000	24140SWRCE4	214	226	326	290	2.5	0.39	2.6	1.8	1.7	51.3	
340		140	3	1 960	2 660	199 000	271 000	24140SWRCAME4	214	—	326	290	2.5	0.39	2.5	1.7	1.7	50.8	
360		98	4	1 300	2 010	133 000	204 000	22240SWRCAME4	218	—	342	315	3	0.26	3.8	2.6	2.5	42.6	
220		340	90	3	1 360	1 980	139 000	202 000	23044SWRCAME4	234	—	326	302	2.5	0.24	4.1	2.8	2.7	29.7
		340	118	3	1 640	2 490	168 000	265 000	24044SWRCE4	234	244	326	296	2.5	0.31	3.2	2.1	2.1	40.5
		340	118	3	1 310	2 490	134 000	254 000	24044SWRCAME4	234	—	326	296	2.5	0.32	3.2	2.1	2.1	39
	370	150	4	1 800	3 200	183 000	325 000	24144SWRCE4	238	248	352	313	3	0.39	2.6	1.7	1.7	66.7	
	370	150	4	1 800	3 200	183 000	325 000	24144SWRCAME4	238	—	352	313	3	0.39	2.6	1.7	1.7	64.3	
	400	108	4	1 570	2 430	160 000	247 000	22244SWRCAME4	238	—	382	348	3	0.27	3.7	2.5	2.4	59	
240	400	144	4	2 010	3 400	206 000	350 000	23244SWRCE4	238	260	382	337	3	0.35	2.9	1.9	1.9	80.4	
	360	118	3	1 730	2 730	176 000	278 000	24048SWRCAME4	254	—	346	317	2.5	0.30	3.3	2.2	2.2	42.2	
	400	160	4	2 660	3 800	272 000	385 000	24148SWRCAME4	258	—	382	341	3	0.38	2.7	1.8	1.8	79.6	

Air Turbine Dental Handpieces
Pumps & Compressors
Agricultural Machinery
Construction Machinery
Mining Machinery
Railway Rolling Stock
Papermaking Machines
Wind Power Industry
Steel Industry

■ Bearings for Continuous Casting Machines

RUB Series Cylindrical Roller Bearings With Aligning Rings (for Free End)
Bore Diameter 90 – 240 mm
With Cage

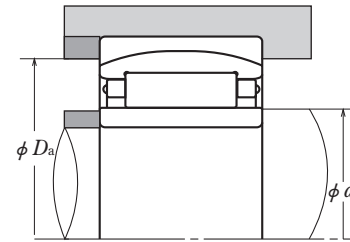
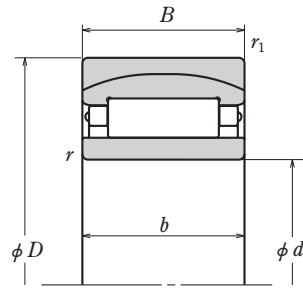

Boundary Dimensions (mm)						Basic Load Ratings (kN)		Bearing Designation	Abutment and Fillet Dimensions (mm)				
<i>d</i>	<i>D</i>	<i>B</i>	<i>b</i>	<i>r</i> min.	<i>r</i> ₁ min.	<i>C</i> _r	<i>C</i> _{0r}		<i>d</i> _a min.	<i>d</i> _a max.	<i>D</i> _a min.		
90	160	56	50	1.1	2	220	335	90RUB1601P	99	105	143		
	170	68	52.4	2	2	270	375		99	106	153		
	190	64	64	3	3	340	490		103	109	166		
100	165	52	52	2	1.1	221	385	100RUB31AP	106.5	113	147		
	165	58	52	2	1.1	221	385		106.5	113	147		
	180	46	46	2.1	2.1	251	375		111	117	163		
	215	73	73	3	1.5	435	595		108	125	190		
110	170	75	45	1.1	1.1	191	325	110RUB1701P	116.5	121	155		
	120	180	46	46	2.5	2.5	215		415	132	133	165	
120	180	76	46	2	2	215	415	120RUB30P	129	133	166		
	200	80	80	2	2	370	680		129	136	174		
	124.96	255	133	66	2.1	5	430		590	144.96	154	229	
130	200	79	52	2	2	261	440	130RUB2001P	139	144	184		
	230	90	90	3	3	540	930		143	149	200		
140	250	68	68	3	3	480	740	140RUB22P	153	161	227		
	150	250	100	100	2.1	2.1	540		1 040	161	169	219	
150	270	130	96	3	3	690	1 210	150RUB2702P	163	172	236		
	180	280	100	100	2.1	2.1	635		1 300	180RUB40P	191	200	250
		300	136	96	3	3	630		1 250		193	203	260
300		158	118	3	3	755	1 460	193	203		260		
180RUB3201P	320	140	112	4	4	950	1 690	196	207	279			
	200	310	82	82	2.5	2.5	635	1 210	200RUB30P	213	222	286	
310		109	109	2.1	2.1	770	1 540	211		222	280		
340		140	140	3	3	1 080	2 200	213		229	295		
220	380	120	120	4	4	1 090	1 950	220RUB3801P	236	251	341		
	400	108	108	4	4	1 040	1 770		236	255	358		
240	400	150	128	4	4	1 260	2 500	240RUB4001P	256	269	362		

Air Turbine Dental Handpieces
 Pumps & Compressors
 Agricultural Machinery
 Construction Machinery
 Mining Machinery
 Railway Rolling Stock
 Papermaking Machines
 Wind Power Industry
Steel Industry
 INDUSTRY SOLUTIONS

■ Bearings for Continuous Casting Machines

RUB Series Cylindrical Roller Bearings With Aligning Rings (for Free End)

Bore Diameter 50 – 110 mm

Full Complement

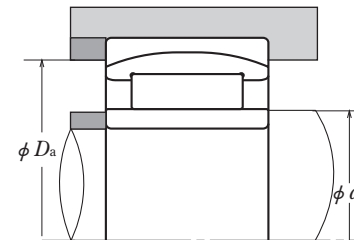
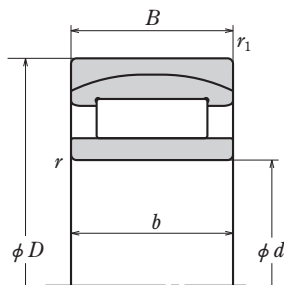

Boundary Dimensions (mm)						Basic Load Ratings (kN)		Bearing Designation	Abutment and Fillet Dimensions (mm)			
<i>d</i>	<i>D</i>	<i>B</i>	<i>b</i>	<i>r</i> min.	<i>r</i> ₁ min.	<i>C</i> _r	<i>C</i> _{0r}		<i>d</i> _a min.	<i>d</i> _a max.	<i>D</i> _a min.	
50	90	23	23	1.5	1.5	69.5	104	50RUB22PV	57	58	80	
	110	40	40	2	2	140	295		50RUB23PV	59	70	94
55	90	32	32	1.1	1.1	82	195	55RUB9001PV	61.5	62.5	80	
	100	25	25	1.5	1.5	88	121		55RUB22APV	62	63	90
65	120	31	31	1.5	1.5	131	200	65RUB22PV	73	75	107	
	140	48	48	2.1	2.1	221	440		65RUB23PV	76	85	121
70	125	31	31	1.5	1.5	127	213	70RUB22APV	78	85	113	
75	130	31	31	1.5	1.5	151	248	75RUB22APV	83	85	118	
85	150	65	65	2.5	2.5	286	595	85RUB1501P	97	98	130	
90	150	72	60	1.5	1	262	575	90RUB1501PV	95	101	131	
	190	64	64	3	1.5	415	780		90RUB23APV	98	116	168
100	150	50	50	2	2	230	530	100RUB40PV	108	109	134	
	150	66	50	2	2	230	530		100RUB1501PV	108	109	134
	165	52	52	2	2	272	550		100RUB31PV	109	113	147
100	180	46	46	2.1	2.1	277	545	100RUB22APV	111	123	164	
	180	60.3	60.3	2.1	2.1	360	650		100RUB32PV	111	116	160
103	180	60	60	2	2	330	790	103RUB1801PV	112	132	163	
110	170	45	45	2	2	246	565	110RUB30A1PV	119	123	155	
	170	60	60	2	2	300	735		110RUB40PV	119	123	151
	180	56	56	2.5	2.5	335	670		110RUB31A1PV	123	124	161
110	180	69	69	2	2	385	835	110RUB41A2PV	119	123	157	
	200	53	53	2.5	2.1	380	625		110RUB22APV	121	130	180

Air Turbine Dental Handpieces
Pumps & Compressors
Agricultural Machinery
Construction Machinery
Mining Machinery
Railway Rolling Stock
Papermaking Machines
Wind Power Industry
Steel Industry

Air Turbine Dental Handpieces
Pumps & Compressors
Agricultural Machinery
Construction Machinery
Mining Machinery
Railway Rolling Stock
Papermaking Machines
Wind Power Industry
Steel Industry

■ Bearings for Continuous Casting Machines

RUB Series Cylindrical Roller Bearings With Aligning Rings (for Free End)

Bore Diameter 120 – 160 mm

Full Complement

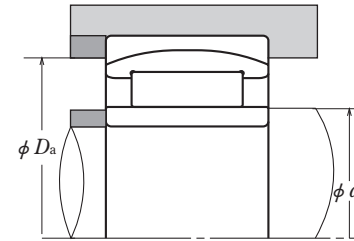
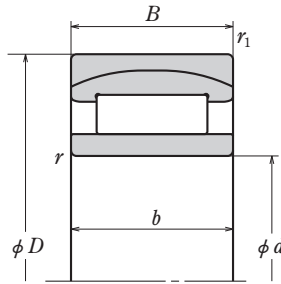

d	D	Boundary Dimensions (mm)				Basic Load Ratings (kN)		Bearing Designation	Abutment and Fillet Dimensions (mm)		
		B	b	r min.	r ₁ min.	C _r	C _{0r}		d _a min.	d _a max.	D _a min.
120	180	46	46	2	2	275	625	120RUB30B2PV	129	132	165
	180	60	60	2	2	330	790	120RUB40A2PV	129	132	163
	180	80	60	2	2	330	790	120RUB1803PV	129	132	163
	200	80	80	2.5	2.5	470	1 040	20RUB41A1PV	133	137	174
	225	58	58	2.5	2.5	460	690	120RUB2201APV	133	138	204
130	200	69	69	2	2	410	955	130RUB40A1PV	139	143	180
	210	64	64	2	2	415	865	130RUB31APV	139	144	189
	210	80	80	2	2	510	1 130	130RUB41A2PV	139	144	184
	230	64	64	3	3	495	840	130RUB22APV	143	151	208
	230	80	80	3	3	585	1 090	130RUB32APV	143	146	204
140	210	53	53	2	2	365	885	140RUB30A2PV	149	155	194
	210	69	69	2	2	420	990	140RUB40APV	149	152	190
	225	68	68	2.1	2.1	485	1 000	140RUB31APV	151	156	203
	225	85	85	2.1	2.1	575	1 310	140RUB41A1PV	151	156	200
	250	68	68	3	3	510	1 110	140RUB22APV	153	172	227
150	250	88	88	3	3	670	1 500	140RUB32PV	153	170	221
	225	56	56	2.5	2.5	390	840	150RUB30APV	163	166	208
	225	75	75	2.1	2.1	485	1 210	150RUB40A1PV	161	165	203
	225	92	75	2.1	2.1	465	1 160	150RUB2201PV	161	164	203
	250	80	80	2.1	2.1	595	1 290	150RUB31APV	161	170	221
160	250	100	100	2.1	2.1	710	1 620	150RUB41APV	161	170	219
	270	96	96	3	3	815	1 640	150RUB32APV	163	174	236
	240	80	80	2.1	2.1	530	1 330	160RUB40A1PV	171	176	217
	240	85	80	2.1	2.1	530	1 330	160RUB2402PV	171	176	217
	270	109	109	2.1	2.1	855	1 830	160RUB41AE2PV	171	181	237

Air Turbine
Dental
Handpieces

Pumps &
Compressors

Agricultural
Machinery

Construction
Machinery

Mining
Machinery

Railway
Rolling Stock

Papermaking
Machines

Wind Power
Industry

Steel Industry

Air Turbine
Dental
Handpieces

Pumps &
Compressors

Agricultural
Machinery

Construction
Machinery

Mining
Machinery

Railway
Rolling Stock

Papermaking
Machines

Wind Power
Industry

Steel Industry

INDUSTRY
SOLUTIONS

INDUSTRY
SOLUTIONS

■ Bearings for Continuous Casting Machines

RUB Series Cylindrical Roller Bearings With Aligning Rings (for Free End)

Bore Diameter 170 – 240 mm

Full Complement

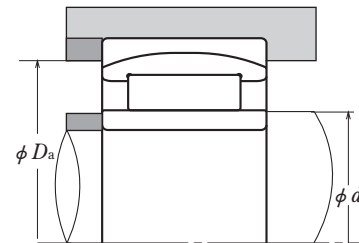
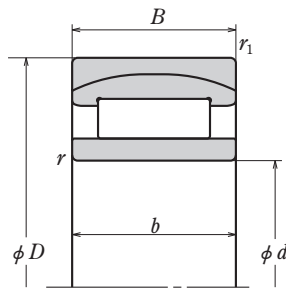

<i>d</i>	<i>D</i>	Boundary Dimensions (mm)				Basic Load Ratings (kN)		Bearing Designation	Abutment and Fillet Dimensions (mm)		
		<i>B</i>	<i>b</i>	<i>r</i> min.	<i>r</i> ₁ min.	<i>C</i> _r	<i>C</i> _{0r}		<i>d</i> _a min.	<i>d</i> _a max.	<i>D</i> _a min.
170	260	67	67	2.1	2.1	555	1 130	170RUB30APV 170RUB40A1PV 170RUB32APV	181	188	239
	260	90	90	2.1	2.1	655	1 580		181	188	233
	310	110	110	4	4	1 060	2 090		186	195	273
180	280	100	100	2.5	2.5	785	1 870	180RUB40APV 180RUB41APV 180RUB32APV	193	198	250
	300	118	118	3	3	940	2 120		193	202	260
	320	112	112	4	4	1 090	2 190		196	204	279
190	290	100	100	2.1	2.1	850	2 100	190RUB40A1PV 190RUB31APV 190RUB32APV	201	210	260
	320	104	104	3	3	1 050	2 240		203	214	286
	340	120	120	4	4	1 210	2 430		206	218	297
200	310	109	109	2.1	2.1	1 030	2 550	200RUB40A1PV 200RUB31APV 200RUB41APV	211	219	280
	340	112	112	3	3	1 160	2 470		213	230	305
	340	140	140	3	3	1 340	3 100		213	230	295
220	340	90	90	3	3	905	2 020	220RUB30PV 220RUB40APV 220RUB3401PV 220RUB41APV	233	243	313
	340	118	118	3	3	1 110	2 630		233	243	308
	340	135	118	3	3	1 010	2 670		233	247	308
	370	150	150	4	4	1 510	3 500		236	248	322
240	400	128	128	4	4	1 540	3 400	240RUB31APV	256	271	362

Air Turbine Dental Handpieces
Pumps & Compressors
Agricultural Machinery
Construction Machinery
Mining Machinery
Railway Rolling Stock
Papermaking Machines
Wind Power Industry

Steel Industry

Air Turbine Dental Handpieces
Pumps & Compressors
Agricultural Machinery
Construction Machinery
Mining Machinery
Railway Rolling Stock
Papermaking Machines
Wind Power Industry

Steel Industry

INDUSTRY SOLUTIONS

INDUSTRY SOLUTIONS

■ Bearings for Continuous Casting Machines

RNPH Series Split Cylindrical Roller Bearings (for Segmented Rolls)

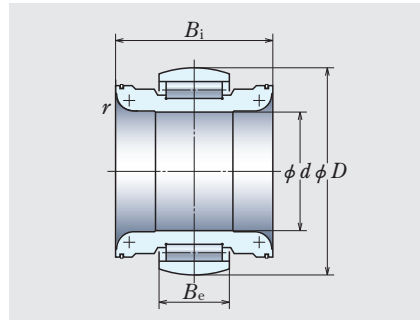

Fig. 1

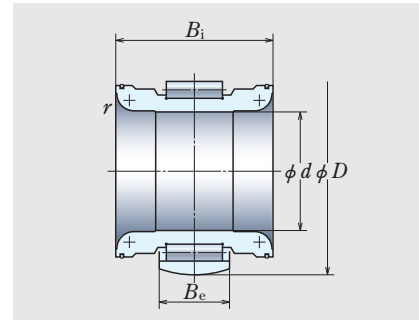
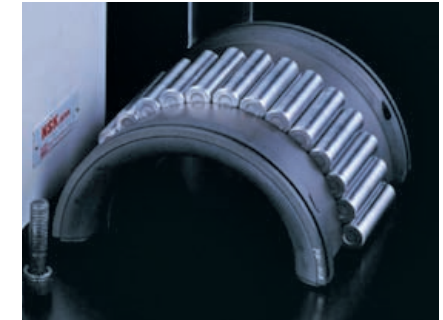

Fig. 2



Bearing Designation	Boundary Dimensions (mm)					Basic Load Ratings (kN)		Roll Diameter (mm)	Fig.
	<i>d</i>	<i>D</i>	<i>B_i</i>	<i>B_e</i>	<i>r</i>	<i>C_r</i>	<i>C_{0r}</i>		
100RNPH1801	100	185	169	74	15	475	950	225	2
110RNPH1801	110	180	137	49	15	272	570	230	2
110RNPH1803	110	185	154	76	20	450	1 070	230	2
110RNPH2001	110	200	179	80	20	535	1 090	250	2
115RNPH2001	115	205	202	98	15	625	1 460	240	2
120RNPH1901	120	195	157	66	20	410	950	250	2
120RNPH2001	120	205	179	80	20	560	1 220	255	2
130RNP2001	130	205	139	60	20	455	1 030	270	1
130RNP2101	130	215	174	75	20	540	1 190	280	1
130RNPH2105	130	215	143	60	20	460	975	250	2
130RNPH2107	130	215	174	75	20	550	1 230	250	2
130RNPH2201	130	225	189	90	20	670	1 460	280	2
130RNPH2202	130	220	186	79	20	555	1 370	280	2
135RNPH2101	135	215	183	84	20	570	1 350	250	2
135RNPH2102	135	210	183	84	20	515	1 350	250	2
140RNPH2102	140	215	162	60	20	415	950	270	2
140RNPH2103	140	215	189	74	2.5	490	1 170	265	2
140RNPH2302	140	235	194	84	20	665	1 530	285	2
140RNP2401	140	245	184	85	20	710	1 510	310	1
145RNPH2201	145	225	179	76	20	560	1 340	280	2
145RNPH2303	145	232	196	84	20	630	1 440	280	2
145RNPH2401	145	240	208	89	20	765	1 780	295	2
150RNPH2303	150	230	199	78	2.5	555	1 340	280	2
150RNPH2401	150	245	159	80	20	680	1 550	280	2
150RNPH2403	150	240	195	84	18	690	1 630	290	2
150RNPH2503	150	250	169	70	20	640	1 500	300	2
150RNPH2505	150	250	208	89	20	780	1 840	295	2
150RNPH2601	150	265	187	98	20	900	1 950	320	2
150RNPH2702	150	275	199	100	20	945	1 970	330	2
155RNPH2401	155	245	199	88	20	740	1 720	300	2
160RNPH2502	160	255	199	90	20	735	1 730	310	2
160RNPH2504	160	255	189	86	20	745	1 780	305	2
160RNPH2601	160	265	200	82	20	745	1 700	320	2
160RNPH2703	160	275	214	100	25	945	2 190	325	2
170RNPH2601	170	265	214	100	20	880	2 050	330	2
180RNPH2901	180	290	214	85	20	880	2 050	335	2

Remark Other bearings are available. Please contact NSK for additional information.

Air Turbine Dental Handpieces
 Pumps & Compressors
 Agricultural Machinery
 Construction Machinery
 Mining Machinery
 Railway Rolling Stock
 Papermaking Machines
 Wind Power Industry
Steel Industry
 INDUSTRIAL SOLUTIONS

Bearings for Continuous Casting Machines

PCR Series Plummer Units for Split Cylindrical Roller Bearings

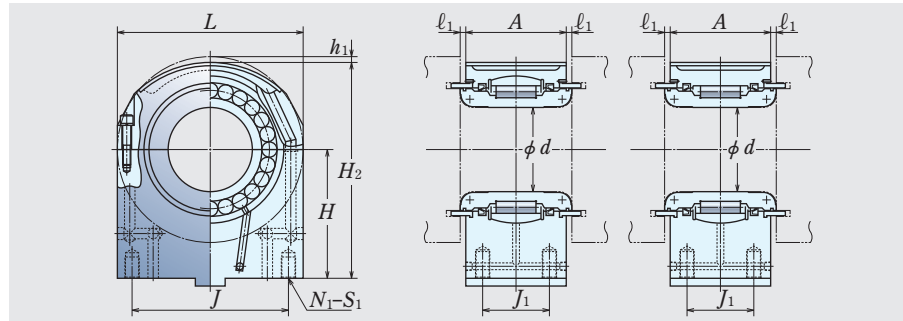

Bearing Designation	Shaft Diameter (mm)	Boundary Dimensions (mm)									
	<i>d</i>	<i>L</i>	<i>A</i>	<i>H</i>	<i>h</i> ₁	<i>H</i> ₂	<i>l</i> ₁	<i>J</i>	<i>J</i> ₁	<i>N</i> ₁	<i>S</i> ₁
100PCR2201	100	235	152	132	10	234.5	9	165	100	4	M20
110PCR2301	110	230	120	160	10	265	9.5	140	—	2	M30
110PCR2303	110	230	135	180	10	285	10	170	—	2	M30
110PCR2502	110	250	156	150	11.5	263.5	12	—	—	1	M36
115PCR2401	115	245	183	190	10	300	10	150	—	2	M24
120PCR2501	120	250	142	165	11.5	278.5	9	190	90	4	M24
120PCR2502	120	255	162	230	10	347.5	9	205	100	4	M24
130PCR2701	130	265	118	190	11.5	313.5	11	195	65	4	M30
130PCR2801	130	280	156	160	10	290	9.5	200	100	4	M24
130PCR2705	130	270	132	197	9	313	6	220	93	4	3/4-10UNC
130PCR2604	130	265	175	145	10	260	7.5	210	120	4	M16
130PCR2802	130	280	172	180	11.5	308.5	9	220	110	4	M30
130PCR2603	130	265	171	175	12.5	295	8	230	90	4	M20
135PCR2701	135	270	160	160	10	275	12	180	130	4	M20
135PCR2502	135	250	160	160	10	275	12	150	130	4	M20
140PCR2701	140	270	145	180	10	305	9.5	170	—	2	M30
140PCR2601	140	265	174	175	7.5	300	8	230	130	4	M20
140PCR2804	140	285	179	175	12.5	305	8	250	97.5	4	M20
140PCR3101	140	310	166	175	10	320	9.5	220	110	4	M24
145PCR2801	145	280	162	250	10	380	9	220	100	4	M30
145PCR2804	145	280	183	260	10	390	7	220	123	4	M30
145PCR2901	145	295	195	270	10	407.5	7	230	130	4	M30
150PCR2801	150	280	184	175	10	305	8	230	140	4	M20
150PCR280	150	330	144	310	10	440	8	350	260	4	φ33
150PCR3004	150	305	180	205.5	14.5	336	8	230	120	4	M24
150PCR3003	150	300	150	180	10	320	10	195	90	4	M30
150PCR2901	150	295	193	310	10	447.5	8	215	126	4	M30
150PCR3203	150	320	168	220	15	365	10	240	90	4	M36
150PCR3301	150	330	182	220	11.5	373.5	9	260	110	4	M36
155PCR3001	155	300	182	260	10	400	9	240	110	4	M30
160PCR3101	160	310	178	185	16.5	323.5	11	150	—	2	M30
160PCR3002	160	305	174	217	12.5	357	8	255	135	4	3/4-10UNC
160PCR3302	160	330	185	225	20	365	8	250	130	4	M24
160PCR3401	160	340	199	200	15.5	347	8	290	130	4	M20
170PCR3301	170	320	194	290.5	10	445.5	10.5	260	340	4	φ26
180PCR3301	180	335	150	217.5	10	375	10	240	82	4	M30

Remark Other bearings are available. Please contact NSK for additional information.
D 126

Air Turbine
Dental
Handpieces

Pumps &
Compressors

Agricultural
Machinery

Construction
Machinery

Mining
Machinery

Railway
Rolling Stock

Papermaking
Machines

Wind Power
Industry

Steel Industry

INDUSTRY SOLUTIONS

Bearings for Rolling Mills

Four-Row Tapered Roller Bearings for Roll Necks

- Benefits**
- ❶ Higher reliability and longer operating life prevent unexpected accidents
 - ❷ Bearing seal requires less cleaning of work environment and reduces grease consumption
 - ❸ Lower maintenance costs

1. Operating conditions

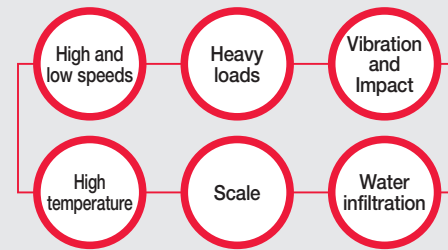

Major target mills:

- Hot strip mills
- Cold rolling mills
- Skin pass mills
- Temper rolling mills

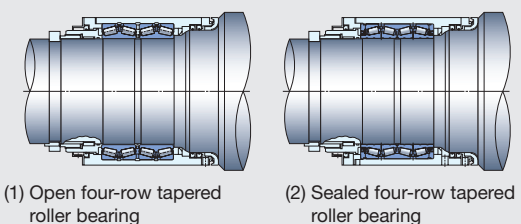
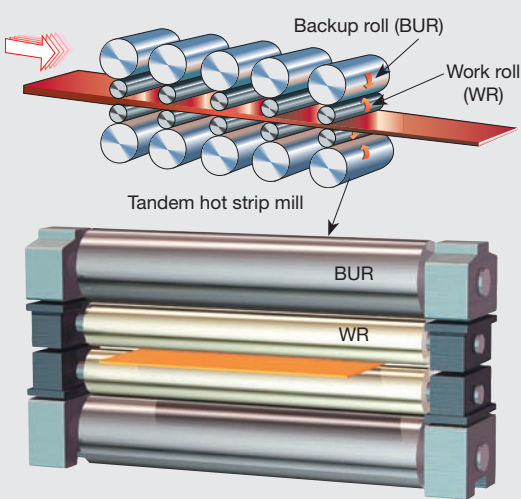

2. Problems

Typical problems for work roll bearings

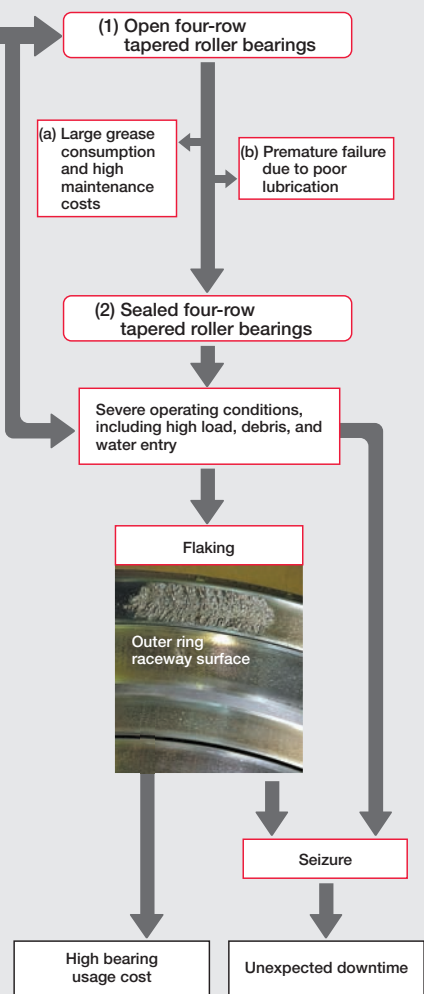

3. Countermeasures

Design countermeasures

Features KVS Series Extra-Capacity Sealed-Clean™ Four-Row Tapered Roller Bearings

- Load capacity increased by 15%~35% compared to conventional sealed bearings
- Adoption of Super-TF™ steel as standard
- A new type of intermediate seal controls negative pressure during operation to prevent infiltration of water
- Improved sealing through usage of heat- and wear-resistant sealing materials
- Easier handling of seals

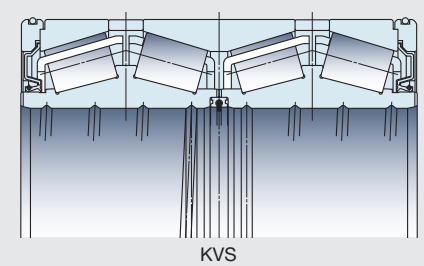

Material Countermeasures 1

Features Super-TF™ Bearings

- Adoption of Super-TF™ material
- Control of retained austenite reduces stress concentrations resulting from dents caused by infiltration of debris

	Comparison of Actual Life Extension in Field Test	
Conventional Sealed Bearing	1	
KVS Bearing	2	

Super-TF™ steel is standard for the KVS Series but can also be used with the KVE Series.

Material Countermeasures 2

Features Water-TF™ Bearings-WTF Series

- Adoption of super-clean steel with an optimum alloy balance controls development and progress of cracks caused by water infiltration at early stages of flaking
- Control of retained austenite reduces stress concentrations resulting from dents caused by infiltration of debris

	Comparison of Actual Life Extension in Field Test	
Conventional Steel	1	
Material for Water TF Bearing	3	

Water-TF™ steel is used as a special-purpose specification for the KVS Series, though it can also be used with the KVE Series.

Note (*1): Photo courtesy of NIPPON STEEL & SUMITOMO METAL CORPORATION KASHIMA WORKS.

Air Turbine Dental Handpieces
 Pumps & Compressors
 Agricultural Machinery
 Construction Machinery
 Mining Machinery
 Railway Rolling Stock
 Papermaking Machines
 Wind Power Industry
Steel Industry
 INDUSTRY SOLUTIONS

Air Turbine Dental Handpieces
 Pumps & Compressors
 Agricultural Machinery
 Construction Machinery
 Mining Machinery
 Railway Rolling Stock
 Papermaking Machines
 Wind Power Industry
Steel Industry
 INDUSTRY SOLUTIONS

■ Bearings for Rolling Mills

**Super-TF/Water-TF Series Sealed Four-Row Tapered Roller Bearings
(Figures of Typical Four-Row Tapered Roller Bearings)**

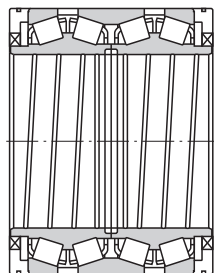

Fig. 1 Basic Design of Two-Seal Type (KVE)

Variations	
1-1	Oil holes in outer ring spacers
1-2	Without an intermediate bore seal (for dry rolling)
1-3	Without an intermediate bore seal, with holes in outer ring spacers
1-4	With inner ring spacer, with an intermediate bore seal
1-5	For vertical rolls (special outer ring spacers)

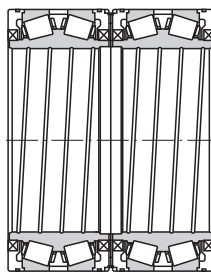

Fig. 2 Basic Design of Four-Seal Type (KVE)

Variations	
2-1	Oil holes in outer ring spacers
2-2	Clearance between inner ring faces

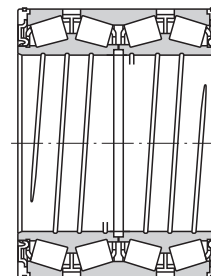

Fig. 3 Basic Design of Two-Seal Type (KVS)

Variations	
3-1	Oil holes in outer ring spacers

Air Turbine
Dental
Handpieces

Pumps &
Compressors

Agricultural
Machinery

Construction
Machinery

Mining
Machinery

Railway
Rolling Stock

Papermaking
Machines

Wind Power
Industry

Steel Industry

Air Turbine
Dental
Handpieces

Pumps &
Compressors

Agricultural
Machinery

Construction
Machinery

Mining
Machinery

Railway
Rolling Stock

Papermaking
Machines

Wind Power
Industry

Steel Industry

INDUSTRY
SOLUTIONS

■ Bearings for Rolling Mills

Super-TF/Water-TF Series Sealed Four-Row Tapered Roller Bearings
Bore Diameter 101.600 – 250 mm

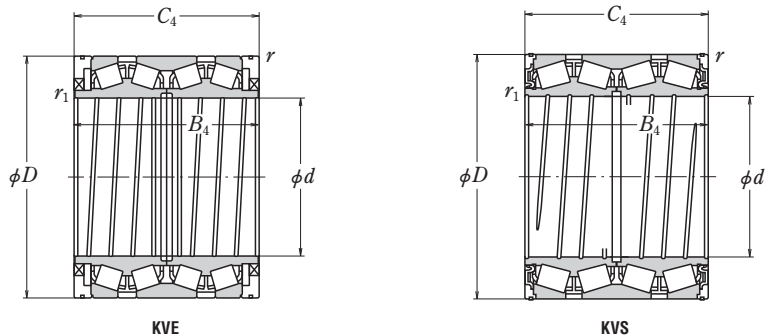

Dynamic Equivalent Load

$$P = XF_r + YF_a$$

$F_a/F_r \leq e$		$F_a/F_r > e$	
X	Y	X	Y
1	Y_3	0.67	Y_2

Static Equivalent Load

$$P_0 = F_r + Y_0 F_a$$

Where $Y_0 \approx Y_3$

The values of e , Y_2 , and Y_3 are given in the table below.

Boundary Dimensions (mm/inch)						Basic Load Ratings				Bearing Designations		Figure ⁽¹⁾	Axial Load Factors			Mass (kg) approx.
d	D	B_4	C_4	r_1 min.	r min.	C_r (kN)	C_{0r} (kgf)	C_r (kgf)	C_{0r} (kgf)	Super-TF Series	Water-TF Series		Constant e	Y_2	Y_3	
101.600 4.000	200.025 7.8750	320.000 12.5984	320.000 12.5984	1.0	3.0	1 450	2 420	148 000	247 000	*STF101KVE2051Eg		1-2	0.36	2.8	1.9	47.8
150	210	240	240	1	2.5	990	2 270	101 000	231 000	STF150KVE2101Eg		1-1	0.32	3.2	2.1	26.1
170	240	175	175	2.5	2.5	1 020	2 000	103 000	204 000	STF170KVS2401Eg		3	0.32	3.2	2.1	23
187.325 7.3750	269.875 10.6250	230.000 9.0551	230.000 9.0551	2.0	3.3	1 460	3 200	149 000	325 000	*STF187KVE2651Eg		1-1	0.29	3.4	2.3	43.6
215.900 8.5000	288.925 11.3750	177.800 7.0000	177.800 7.0000	0.8	3.3	1 070	2 350	109 000	239 000	*STF215KVS2851Eg	*WTF215KVS2851Eg	3	0.49	2.1	1.4	38
216.103 8.5080	330.2 13.0000	263.525 10.3750	269.875 10.6250	1.5	3.3	2 290	4 550	233 000	465 000	*STF216KVS3351Eg	*WTF216KVS3351Eg	3	0.46	2.2	1.5	77
220	295	315	315	1	2.5	1 410	3 450	144 000	350 000	STF220KVE2902Eg	WTF220KVE2902Eg	2-1	0.40	2.5	1.7	61.2
	295	335	335	1	2.5	1 410	3 450	144 000	350 000	STF220KVE2901Eg	WTF220KVE2901Eg	2-1	0.40	2.5	1.7	65
	300	270	270	2.5	2.5	1 650	4 000	168 000	410 000	STF220KVE3001Eg	WTF220KVE3001Eg	1-2	0.41	2.5	1.7	56.5
	320	290	290	1.5	2.5	1 970	4 500	201 000	460 000	STF220KVE3201Eg	WTF220KVE3201Eg	1	0.33	3.0	2.0	78.7
	330	260	260	4	3	2 330	4 800	237 000	490 000	STF220KVS3301Eg	WTF220KVS3301Eg	3	0.40	2.5	1.7	76
225	320	230	230	1	2	1 510	3 300	154 000	335 000	STF225KVE3201Eg	WTF225KVE3201Eg	1	0.41	2.4	1.6	59.9
228.600 9.0000	400.050 15.7500	296.875 11.6880	296.875 11.6880	3.3	3.3	2 410	4 250	246 000	435 000	*STF228KVE4052Eg	*WTF228KVE4052Eg	1	0.46	2.2	1.5	161
234.950 9.2500	327.025 12.8750	196.850 7.7500	196.850 7.7500	1.5	3.3	1 550	3 200	158 000	325 000	*STF234KVS3251Eg	*WTF234KVS3251Eg	3	0.46	2.2	1.5	49
240	320	250	250	3	3	1 510	3 700	154 000	375 000	STF240KVE3202Eg	WTF240KVE3202Eg	1	0.33	3.0	2.0	56.3
	338	248	248	2	3	1 820	4 000	185 000	405 000	STF240KVE3301Eg	WTF240KVE3301Eg	1	0.43	2.3	1.6	70.6
	338	290	290	2	3	2 120	5 000	216 000	510 000	STF240KVE3302Eg	WTF240KVE3302Eg	1	0.42	2.4	1.6	82.6
244.475 9.6250	327.025 12.8750	193.680 7.6250	193.680 7.6250	1.5	3	1 370	3 300	148 000	325 000	*STF244KVS3251Eg	*WTF244KVS3251Eg	3	0.40	2.5	1.7	43
245	345	310	310	2	3	2 700	6 650	275 000	680 000	STF245KVS3402Eg	WTF245KVS3402Eg	3	0.40	2.5	1.7	85
250	365	270	270	2.5	3	2 210	4 650	225 000	475 000	STF250KVE3601AEg	WTF250KVE3601AEg	1	0.33	3.0	2.0	96
	365	270	270	2.5	3	2 210	4 650	225 000	475 000	STF250KVE3601Eg	WTF250KVE3601Eg	1-1	0.33	3.0	2.0	96

Remark Inch Series bearings are marked with an asterisk (*).

Note ⁽¹⁾ Refer to Pages D130 and D131.

■ Bearings for Rolling Mills

Super-TF/ Water-TF Series Sealed Four-Row Tapered Roller Bearings
 Bore Diameter 254.000 – 304.902 mm

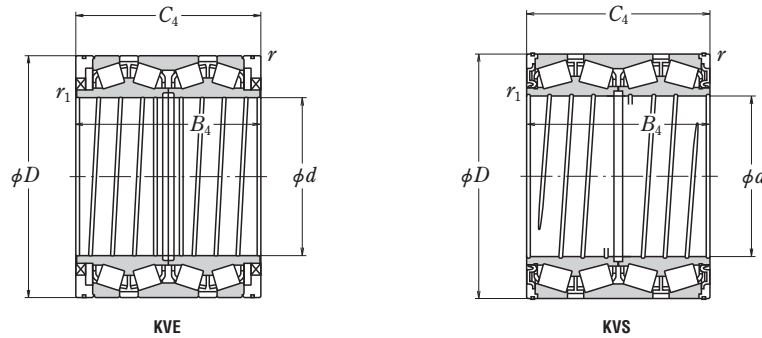

Dynamic Equivalent Load

$$P = XF_r + YF_a$$

$F_a/F_r \leq e$		$F_a/F_r > e$	
X	Y	X	Y
1	Y_3	0.67	Y_2

Static Equivalent Load

$$P_0 = F_r + Y_0 F_a$$

Where $Y_0 \div Y_3$

The values of e , Y_2 , and Y_3 are given in the table below.

Boundary Dimensions (mm/inch)						Basic Load Ratings				Bearing Designations		Figure ⁽¹⁾	Constant e	Axial Load Factors		Mass (kg) approx.
d	D	B_4	C_4	r_1 min.	r min.	C_r (kN)	C_{0r} (kgf)	C_r (kgf)	C_{0r} (kgf)	Super-TF Series	Water-TF Series			Y_2	Y_3	
254.000 10.0000	358.775 14.1250	269.875 10.6250	269.875 10.6250	1.5	3.3	2 420	5 500	247 000	560 000	*STF254KVS3552Eg	*WTF254KVS3552Eg	3	0.40	2.5	1.7	86
260	365 365	340 340	340 340	2.7 2.5	4	2 960	7 350	300 000	750 000	STF260KVS3601Eg STF260KVS3651Eg	WTF260KVS3601Eg WTF260KVS3651Eg	3 3	0.40 0.40	2.5 2.5	1.7 1.7	110 110
260.350 10.2500	422.275 16.6250	314.325 12.3750	317.500 12.5000	6.4	3.3	3 600	7 050	370 000	720 000	*STF260KVS4251Eg	*WTF260KVS4251Eg	3	0.33	3.0	2.0	170
266.700 10.5000	355.600 14.0000	230.188 9.0625	228.600 9.0000	1.5	3.3	1 960	4 600	200 000	470 000	*STF266KVS3551Eg	*WTF266KVS3551Eg	3	0.35	2.9	1.9	62
276.225 10.8750	393.700 15.5000	269.875 10.6251	269.875 10.6251	1.5	3.3	2 720	6 100	277 000	620 000	*STF276KVS3952Eg	*WTF276KVS3952Eg	3	0.45	2.2	1.5	105
279.400 11.0000	393.700 15.5000	269.875 10.6250	269.875 10.6250	1.5	6.4	2 720	6 100	277 000	620 000	*STF279KVS3952Eg	*WTF279KVS3952Eg	3	0.45	2.2	1.5	102
	393.700 15.5000	270.630 10.6547	269.875 10.6250	1.5	6.4	2 290	5 150	233 000	525 000	*STF279KVE3951Eg	*WTF279KVE3951Eg	1	0.41	2.5	1.7	105
279.4	393.7 410	320 420	320 420	1.5 1	6.4 6.4	3 100 3 300	7 350 7 400	315 000 335 000	745 000 755 000	STF279KVS3954Eg STF279KVE4101Eg	WTF279KVS3954Eg WTF279KVE4101Eg	3 2	0.40 0.42	2.5 2.4	1.7 1.6	120 190
280	380 395 395 410 412	290 340 340 268 340	290 340 340 268 340	1.5 1.5 1.5 1.5 3	3 2.5 2.5 6.4 3	2 230 2 950 2 950 2 330 3 300	5 350 7 050 7 050 4 600 7 400	227 000 300 000 300 000 237 000 335 000	545 000 720 000 720 000 470 000 755 000	STF280KVE3801Eg STF280KVE3901Eg STF280KVE3902Eg STF280KVE4101Eg STF280KVE4102Eg	WTF280KVE3801Eg WTF280KVE3901Eg WTF280KVE3902Eg WTF280KVE4101Eg WTF280KVE4102Eg	1-4 1 1 1-4 1-1	0.37 0.40 0.40 0.33 0.42	2.7 2.5 2.5 3.0 2.4	1.8 1.7 1.7 2.0 1.6	96.2 133 133 121 156
290	400	346	346	3	4	3 250	8 400	330 000	855 000	STF290KVS4001Eg	WTF290KVS4001Eg	3	0.40	2.5	1.7	112
304.648 11.9940	438.048 17.2460	280.990 11.0921	279.400 11.0000	3.3	3.3	3 100	6 750	315 000	690 000	*STF304KVS4351Eg	*WTF304KVS4351Eg	3	0.45	2.2	1.5	132
	438.048 17.2460	281.740 11.0921	279.400 11.0000	3.3	3.3	2 630	5 600	268 000	570 000	*STF304KVE4351Eg	*WTF304KVE4351Eg	1-2	0.47	2.1	1.4	140
304.8 12.0000	419.100 16.5000	269.875 10.6250	269.875 10.6250	1.5	6.4	2 850	6 550	291 000	665 000	*STF304KVS4151Eg	*WTF304KVS4151Eg	3	0.33	3.0	2.0	111
304.902 12.0040	412.648 16.2460	266.700 10.5000	266.700 10.5000	1.5	3.3	2 760	6 500	281 000	665 000	*STF304KVS4152Eg	*WTF304KVS4152Eg	3	0.33	3.0	2.0	100

Remark Inch Series bearings are marked with an asterisk (*).

Note ⁽¹⁾ Refer to Pages D130 and D131.

Air Turbine Dental Handpieces
 Pumps & Compressors
 Agricultural Machinery
 Construction Machinery
 Mining Machinery
 Railway Rolling Stock
 Papermaking Machines
 Wind Power Industry
 Steel Industry
 INDUSTRIAL SOLUTIONS

■ Bearings for Rolling Mills

Super-TF/Water-TF Series Sealed Four-Row Tapered Roller Bearings
 Bore Diameter 310 – 482.600 mm

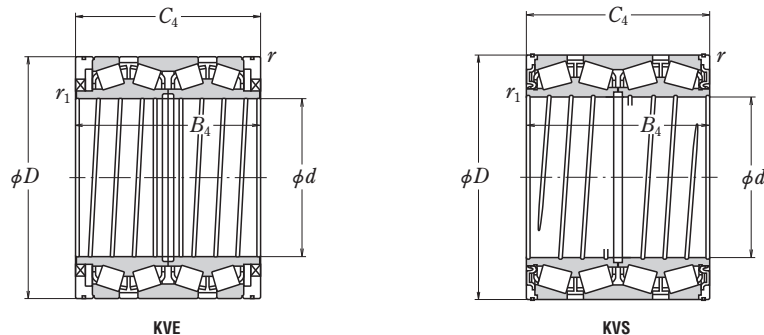

Dynamic Equivalent Load

$$P = XF_r + YF_a$$

$F_a/F_r \leq e$		$F_a/F_r > e$	
X	Y	X	Y
1	Y_3	0.67	Y_2

Static Equivalent Load

$$P_0 = F_r + Y_0 F_a$$

Where $Y_0 \div Y_3$

The values of e , Y_2 , and Y_3 are given in the table below.

Boundary Dimensions (mm/inch)						Basic Load Ratings				Bearing Designations		Figure ⁽¹⁾	Constant e	Axial Load Factors		Mass (kg) approx.
d	D	B_4	C_4	r_1 min.	r min.	C_r (kN)	C_{0r} (kgf)	C_r (kgf)	C_{0r} (kgf)	Super-TF Series	Water-TF Series			Y_2	Y_3	
310	430	310	310	3	3	3 350	8 200	345 000	835 000	STF310KVS4301Eg	WTF310KVS4301Eg	3	0.46	2.2	1.5	140
	430	350	350	2.7	3	3 700	9 550	375 000	970 000	STF310KVS4302Eg	WTF310KVS4302Eg	3	0.46	2.2	1.5	155
317.500 12.5000	422.275	269.875	269.875	1.5	3.3	2 740	6 750	279 000	690 000	*STF317KVS4251Eg	*WTF317KVS4251Eg	3	0.34	3.0	2.0	100
	447.675	367.000	367.000	2.5	3.0	3 450	8 100	350 000	825 000	*STF317KVE4451Eg	*WTF317KVE4451Eg	1	0.46	2.2	1.5	184
343.052 13.5060	457.098	254.000	254.000	1.5	3.3	2 430	6 700	289 000	685 000	*STF343KVS4551Eg	*WTF343KVS4551Eg	3	0.45	2.2	1.5	110
	457.098	299.000	299.000	1.5	3.3	2 830	6 950	289 000	705 000	*STF343KVE4561Eg	*WTF343KVE4561Eg	1	0.46	2.2	1.5	137
355.600 14.0000	457.200	252.412	252.412	1.5	3.3	2 650	6 750	270 000	685 000	*STF355KVS4551Eg	*WTF355KVS4551Eg	3	0.32	3.2	2.1	98
	545	360	360	2.5	5	3 600	9 050	365 000	920 000	STF395KVE5401Eg	WTF395KVE5401Eg	1-1	0.47	2.1	1.4	255
406.400 16.0000	546.100	288.925	288.925	1.5	6.4	3 950	9 450	400 000	965 000	*STF406KVS5451Eg	*WTF406KVS5451Eg	3	0.48	2.1	1.4	184
	546.100	346.000	346.000	0.5	6.4	2 560	5 800	261 000	590 000	*STF406KVE5454Eg	*WTF406KVE5454Eg	2-1	0.47	2.1	1.4	231
420	590	395	375	2.5	5	3 550	8 200	365 000	835 000	STF420KVE5901Eg	WTF420KVE5901Eg	1-1	0.80	1.3	0.8	332
440	590	510	510	4	4	5 450	14 300	555 000	1 460 000	STF440KVE5901Eg	WTF440KVE5901Eg	2-1	0.38	2.7	1.8	396
	620	454	454	4	6	6 500	15 700	665 000	1 600 000	STF440KVE6201Eg	WTF440KVE6201Eg	1-1	0.33	3.0	2.0	435
450	595	368	368	4	5	5 550	15 000	565 000	1 520 000	STF450KVS5901Eg	WTF450KVS5901Eg	3	0.33	3.0	2.0	272
457.200 18.0000	596.900	276.225	279.400	1.5	3.3	4 000	9 850	405 000	1 010 000	*STF457KVS5951Eg	*WTF457KVS5951Eg	3	0.47	2.2	1.4	206
	596.900	276.225	279.400	1.5	3.3	4 000	9 850	405 000	1 010 000	*STF457KVS5951Eg	*WTF457KVS5951Eg	3	0.47	2.2	1.4	206
460	590	470	470	2.5	5	4 900	14 100	500 000	1 440 000	STF460KVE5901Eg	WTF460KVE5901Eg	1-1	0.28	3.6	2.4	322
480	615	435	435	3	5	4 650	12 800	470 000	1 310 000	STF480KVE6101AEg	WTF480KVE6101AEg	2-2	0.32	3.2	2.1	323
	678	574	574	3	5	8 400	21 500	860 000	2 190 000	STF480KVE6702Eg	WTF480KVE6702Eg	2-1	0.34	3.0	2.0	662
482.600 19.0000	615.950	330.200	330.200	4.3	6.4	4 900	13 500	500 000	1 370 000	*STF482KVS6151Eg	*WTF482KVS6151Eg	3	0.33	3.1	2.1	235

Remark Inch Series bearings are marked with an asterisk (*).

Note (1) Refer to Pages D130 and D131.

Air Turbine Dental Handpieces
 Pumps & Compressors
 Agricultural Machinery
 Construction Machinery
 Mining Machinery
 Railway Rolling Stock
 Papermaking Machines
 Wind Power Industry
Steel Industry
 INDUSTRY SOLUTIONS

■ Bearings for Rolling Mills

Super-TF/Water-TF Series Sealed Four-Row Tapered Roller Bearings
 Bore Diameter 482.600 – 825.5 mm

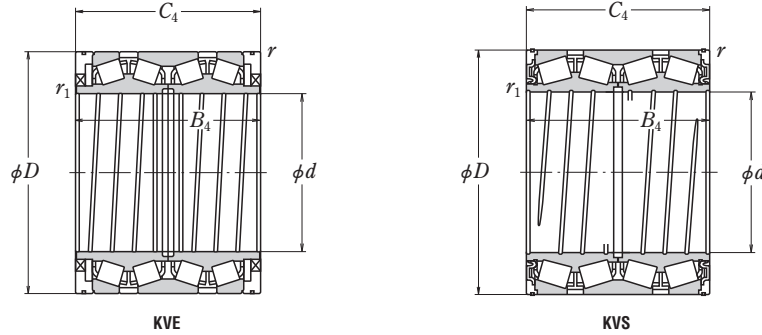

Dynamic Equivalent Load

$$P = XF_r + YF_a$$

$F_a/F_r \leq e$		$F_a/F_r > e$	
X	Y	X	Y
1	Y_3	0.67	Y_2

Static Equivalent Load

$$P_0 = F_r + Y_0 F_a$$

Where $Y_0 \approx Y_3$
 The values of e , Y_2 , and Y_3 are given in the table below.

Boundary Dimensions (mm/inch)						Basic Load Ratings				Bearing Designations		Figure ⁽¹⁾	Constant e	Axial Load Factors		Mass (kg) approx.
d	D	B_4	C_4	r_1 min.	r min.	C_r (kN)	C_{0r} (kgf)	C_r (kgf)	C_{0r} (kgf)	Super-TF Series	Water-TF Series			Y_2	Y_3	
	615.950 24.2500	330.200 13.0000	330.200 13.0000	4.3	6.4	3 650	9 650	370 000	985 000	*STF482KVE6152Eg	*WTF482KVE6152Eg	1	0.37	2.7	1.8	243
	615.950 24.2500	419.100 16.5000	402.050 15.8287	2.3	6.4	4 700	13 600	480 000	1 380 000	*STF482KVE6155Eg	*WTF482KVE6155Eg	1	0.38	2.7	1.8	302
	647.700 25.5000	417.512 16.4375	417.512 16.4375	3.3	6.4	5 500	13 800	560 000	1 410 000	*STF482KVE6453Eg	*WTF482KVE6453Eg	1-5	0.37	2.7	1.8	392
488.950 19.2500	622.300 24.5000	365.125 14.3750	365.125 14.3750	3.8	6.4	3 450	8 950	350 000	915 000	*STF488KVE6251Eg	*WTF488KVE6251Eg	2	0.29	3.5	2.3	272
490	625	435	435	3	5	4 550	12 500	465 000	1 280 000	STF490KVE6201AEg	WTF490KVE6201AEg	2-2	0.32	3.2	2.1	329
509.948 20.0767	654.924 25.7844	377.000 14.8425	379.000 14.9213	1.5	6.4	4 800	13 000	490 000	1 330 000	*STF509KVE6554Eg	*WTF509KVE6554Eg	1	0.41	2.4	1.6	321
520	735	535	535	5	6	8 800	22 700	900 000	2 310 000	STF520KVE7301Eg	WTF520KVE7301Eg	1-1	0.33	3.0	2.0	726
558.800 22.0000	736.600 29.0000	540.000 21.2598	540.000 21.2598	3.3	6.4	8 950	25 300	910 000	2 580 000	*STF558KVE7351Eg	*WTF558KVE7351Eg	1-3	0.35	2.9	1.9	625
595.312 23.4375	844.550 33.2500	615.950 24.2500	615.950 24.2500	1.5	6.4	12 600	33 000	1 290 000	3 350 000	*STF595KVE8451Eg	*WTF595KVE8451Eg	1	0.33	3.0	2.0	1 110
	844.550 33.2500	615.950 24.2500	615.950 24.2500	3.3	6.4	10 900	27 200	1 110 000	2 780 000	*STF595KVE8452Eg	*WTF595KVE8452Eg	4	0.35	2.9	1.9	1 110
609.600 24.0000	787.400 31.0000	361.950 14.2500	361.950 14.2500	1.5	6.4	5 450	14 400	555 000	1 470 000	*STF609KVE7851Eg	*WTF609KVE7851Eg	1	0.42	2.4	1.6	452
711.200 28.0000	914.400 36.0000	387.350 15.2500	317.500 12.5000	3.3	6.4	6 400	19 300	655 000	1 970 000	*STF711KVE9152AEg	*WTF711KVE9152AEg	1	0.38	2.6	1.8	585
	914.400 36.0000	410.000 16.1417	410.000 16.1417	3.3	6.4	7 000	20 100	715 000	2 050 000	*STF711KVE9153Eg	*WTF711KVE9153Eg	1-1	0.44	2.3	1.5	681
	914.400 36.0000	425.450 16.7500	387.350 15.2500	8.0	6.4	6 400	19 300	655 000	1 970 000	*STF711KVE9155Eg	*WTF711KVE9155Eg	1	0.38	2.6	1.8	675
785	1 015	700	700	4	6	13 500	41 000	1 380 000	4 150 000	STF785KVE1001Eg	WTF785KVE1001Eg	2-1	0.40	2.5	1.7	1 460
825.5	1 160	565	565	5	6	13 900	33 500	1 420 000	3 400 000	STF825KVE1101Eg	WTF825KVE1101Eg	1	0.40	2.5	1.7	1 890

Remark Inch Series bearings are marked with an asterisk (*).

Note ⁽¹⁾ Refer to Pages D130 and D131.

Air Turbine Dental Handpieces
 Pumps & Compressors
 Agricultural Machinery
 Construction Machinery
 Mining Machinery
 Railway Rolling Stock
 Papermaking Machines
 Wind Power Industry
 Steel Industry
 INDUSTRY SOLUTIONS

Bearings for Rolling Mills

Four-Row Cylindrical Roller Bearings for Roll Necks

- Benefits**
- ❶ Higher reliability and longer operating life prevent unexpected downtime
 - ❷ Lower maintenance costs
 - ❸ Smoother rolling improves plate making precision

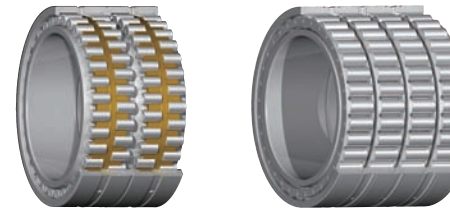

(*1)

1. Operating conditions

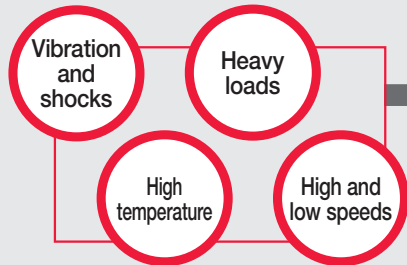

Major target mills:

- Plate mills
- Hot strip mills
- Cold rolling mills
- Skin pass mills
- Temper rolling mills
- Bar mills
- Rod mills
- Section mills

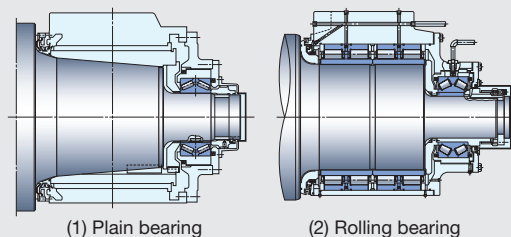
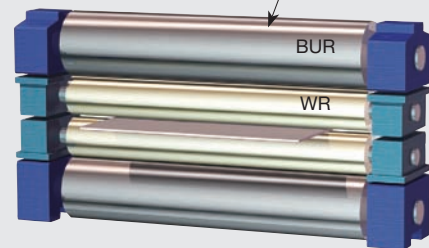
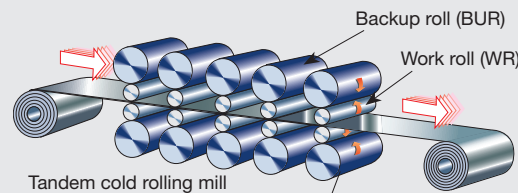

2. Problems

Typical problems for backup roll bearings

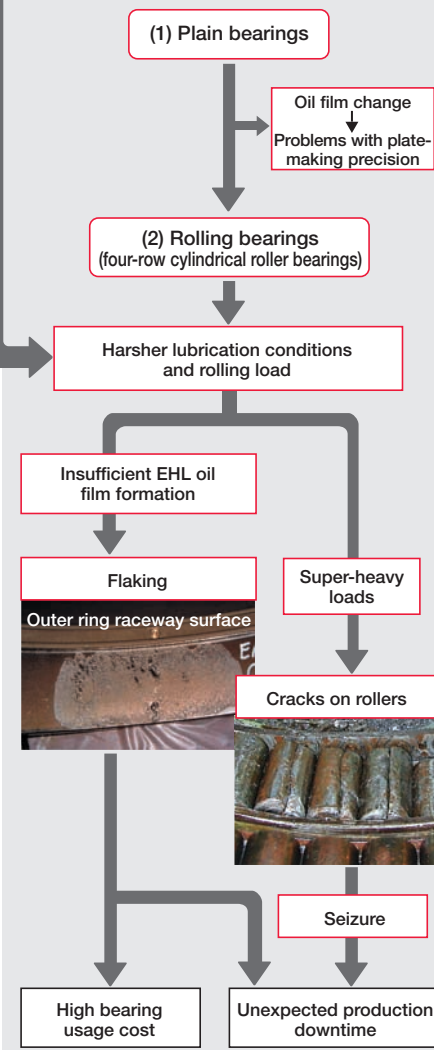

3. Countermeasures

Features Super-TF™ RV Series Four-Row Cylindrical Roller Bearings

- Adoption of long-life Super-TF steel results in longer durability, even under boundary lubrication with insufficient EHL oil film formation
- Higher load capacity
- Higher rotational accuracy

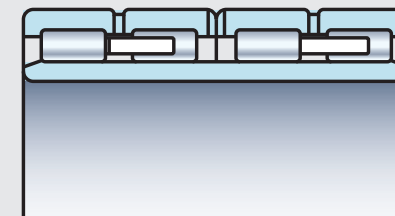

RV (Brass cage)

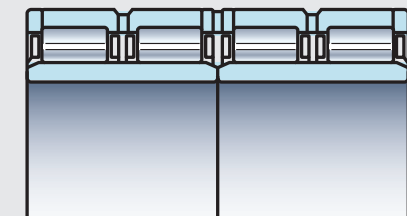

RV (Pin cage)

Comparison of Actual Life Extension in Field Test	
Conventional Steel	1
Super-TF Steel	2

Features Super-TF™ RV Series Stud-Type Four-Row Cylindrical Roller Bearings

Target: bearings for backup rolls of plate mills

- Solid-type rollers and a stud-type cage were developed to protect against roller breakage.
- Higher load capacity
- Adoption of long-life Super-TF steel
- Higher rotational accuracy

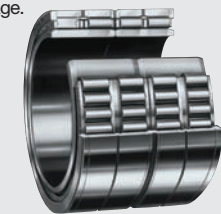
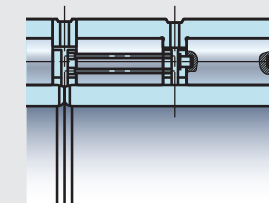

Designations Pages D144 to D165

Instruction Manual CAT.No.E9001 (Roll Neck Bearing Manual)

Super-TF Material Pages A258 to A261

Note (*1): Photo courtesy of NIPPON STEEL & SUMITOMO METAL CORPORATION KASHIMA WORKS.

■ Bearings for Rolling Mills

Four-Row Cylindrical Roller Bearings
Figures of Typical Four-Row Cylindrical Roller Bearings

Cylindrical Bores

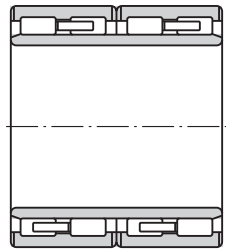

Figure 1

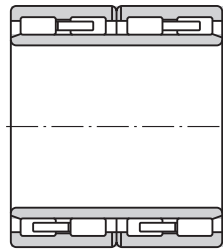

Figure 2

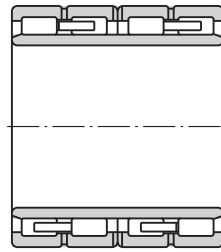

Figure 3

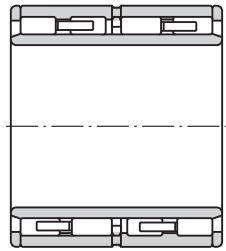

Figure 4

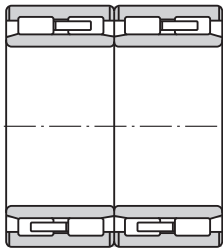

Figure 5

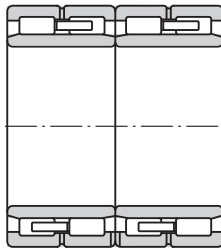

Figure 6

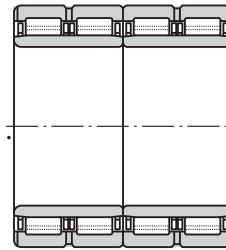

Figure 7

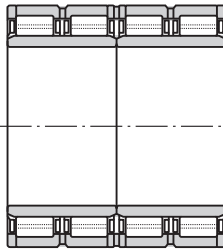

Figure 8

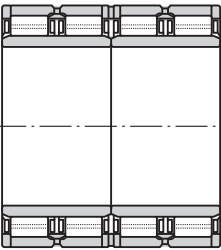

Figure 9

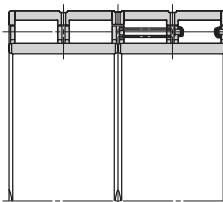

Figure 8SP

Tapered Bores

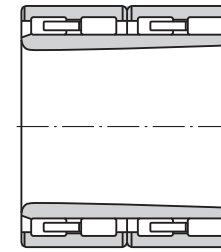

Figure 10

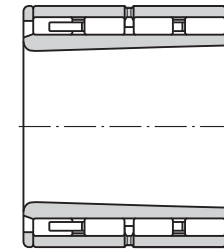

Figure 11

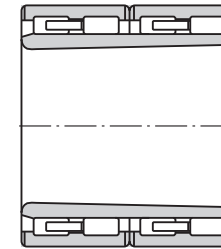

Figure 12

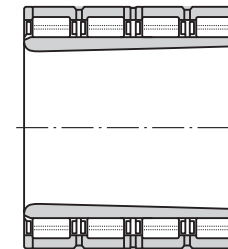

Figure 13

Air Turbine
Dental
Handpieces

Pumps &
Compressors

Agricultural
Machinery

Construction
Machinery

Mining
Machinery

Railway
Rolling Stock

Papermaking
Machines

Wind Power
Industry

Steel Industry

INDUSTRY
SOLUTIONS

Air Turbine
Dental
Handpieces

Pumps &
Compressors

Agricultural
Machinery

Construction
Machinery

Mining
Machinery

Railway
Rolling Stock

Papermaking
Machines

Wind Power
Industry

Steel Industry

INDUSTRY
SOLUTIONS

■ Bearings for Rolling Mills

Four-Row Cylindrical Roller Bearings
Bore Diameter 100 – 160 mm

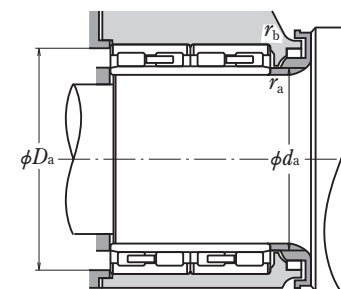
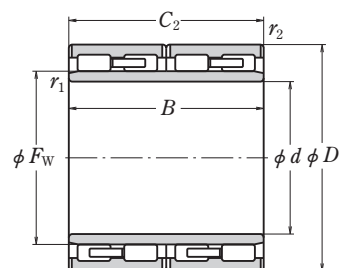

Boundary Dimensions (mm)							Basic Load Ratings (kN)		Bearing Designation	Figure ⁽¹⁾	Abutment and Fillet Dimensions (mm)				Mass (kg) approx.
<i>d</i>	<i>D</i>	<i>B</i>	<i>C</i> ₂	<i>F</i> _w	<i>r</i> ₁ min.	<i>r</i> ₂ min.	<i>C</i> _r	<i>C</i> _{0r}			<i>d</i> _a	<i>D</i> _a	<i>r</i> _a max.	<i>r</i> _b max.	
100	140	104	104	111	1.5	1.1	400	820	HTF100RV1401g	3	110	130	1.5	1	4.8
110	160	120	120	124	1.1	1.1	560	1 080	HTF110RV1601g	3	119	150	1	1	7.9
	170	120	120	127	2	2	615	1 100	HTF110RV1701g	1	122	157	2	2	9.9
120	165	87	87	134.5	1.1	1.1	365	725	HTF120RV1601g	1	130	155	1	1	5.4
	180	105	105	136	2	2	530	880	HTF120RV1801g	1	132	167	2	2	8.9
	215	174	174	147	2.1	2.1	1 060	1 600	HTF120RV2101g	1	134	199	2	2	26.6
127	174.625	150.812	150.812	139.5	1.5	2	735	1 580	HTF127RV1722g	1	138	163	1.5	1.5	10.5
	203.2	127	127	147.5	2	1.5	705	1 110	HTF127RV2001g	1	139	190	2	2	15.4
130	200	125	125	149	2	2	700	1 190	STF130RV2001g	1	142	187	2	2	14
	200	104	104	149	2	2	570	950	STF130RV2003g	1	142	187	2	2	11.7
140	210	116	116	160	2	2	640	1 130	STF140RV2101g	1	152	196	2	2	13.9
	145	210	155	155	166	1.5	1.5	925	1 920	STF145RV2101g	1	157	197	1.5	1.5
225		156	156	169	2	2	975	1 820	STF145RV2201g	1	158	211	2	2	23
150	220	150	150	168	2	2	900	1 700	STF150RV2201g	1	163	206	2	2	20
	225	150	150	168.5	1.5	2.1	970	1 810	STF150RV2203g	1	162	209	1.5	2	20.8
	225	136	136	168.776	2.1	2.1	820	1 460	STF150RV2204g	1	165	209	2	2	18.6
150	230	130	130	174	2.1	2.1	845	1 520	STF150RV2301g	1	165	214	2	2	19.6
	230	156	156	174	2	2	965	1 810	STF150RV2302g	1	163	216	2	2	23.6
159.99	220	180	180	176	2	2	1 050	2 410	STF159RV2201g	2	173	206	2	2	20.6
160	230	130	130	178	2	2	780	1 340	STF160RV2301g	1	173	216	2	2	16.4
	230	168	168	179	2	2	900	2 050	STF160RV2307g	1	173	216	2	2	23.0
	230	168	168	180	2	2	1 040	2 200	STF160RV2302g	1	173	216	2	2	22.7
160	230	180	180	178	2	2	1 080	2 280	STF160RV2303g	2	173	216	2	2	24.2
	240	120	120	183	2.1	2.1	745	1 320	STF160RV2401g	1	175	224	2	2	18.8
	240	170	170	183	2	2	1 080	2 050	STF160RV2402g	1	173	226	2	2	26.6
	240	145	145	180.016	2.1	2.1	920	1 600	STF160RV2403g	1	175	224	2	2	22.3

Note ⁽¹⁾ Refer to Pages D142 and D143.

Air Turbine Dental Handpieces
 Pumps & Compressors
 Agricultural Machinery
 Construction Machinery
 Mining Machinery
 Railway Rolling Stock
 Papermaking Machines
 Wind Power Industry
Steel Industry
 INDUSTRIAL SOLUTIONS

■ Bearings for Rolling Mills

Four-Row Cylindrical Roller Bearings

Bore Diameter 165.1 – 200 mm

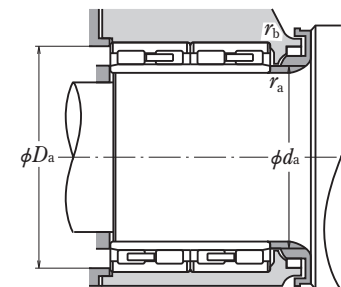
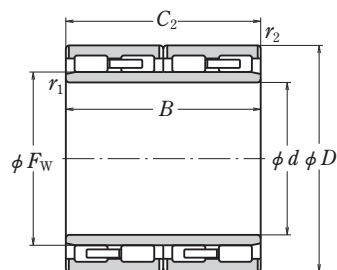

Boundary Dimensions (mm)							Basic Load Ratings (kN)		Bearing Designation	Figure ⁽¹⁾	Abutment and Fillet Dimensions (mm)				Mass (kg) approx.
d	D	B	C ₂	F _w	r ₁ min.	r ₂ min.	C _r	C _{0r}			d _a	D _a	r _a max.	r _b max.	
165.1	225.45	168.3	168.3	180.975	1.5	2.5	1 010	2 220	STF165RV2221g	5	177	209	1.5	2	19.4
170	230	120	120	187	2	2	755	1 610	STF170RV2301g	1	183	216	2	2	14
	240	160	160	190	2	2	1 000	2 130	STF170RV2402g	1	183	226	2	2	22.8
170	250	168	168	192	2.1	2.1	1 210	2 320	STF170RV2501g	1	185	234	2	2	27.4
	250	170	170	192	2.1	2.1	1 210	2 320	STF170RV2502g	1	185	234	2	2	27.7
	255	180	180	193	2.1	2.1	1 310	2 500	STF170RV2503g	1	185	239	2	2	31.5
	260	150	150	195	2.1	2.1	1 030	1 840	STF170RV2602g	1	185	244	2	2	28.2
	180	250	156	156	200	2	2	1 020	2 230	STF180RV2501g	1	193	236	2	2
180	260	168	168	202	2.1	2.1	1 150	2 300	STF180RV2601g	1	195	244	2	2	29.2
	265	180	180	204	2.1	2.1	1 340	2 690	STF180RV2602g	1	195	248	2	2	33.7
	265	180	180	203	2.1	2.1	1 230	2 420	STF180RV2603g	1	195	248	2	2	33.4
180	280	180	180	205.085	2.1	2.1	1 410	2 490	STF180RV2802g	3	195	263	2	2	40.9
	190	260	168	168	212	2	1 140	2 600	STF190RV2601g	1	203	245	2	2	26.6
190	270	200	200	212	2.1	2.1	1 470	3 100	STF190RV2701g	1	206	253	2	2	36
	270	170	170	213	2.1	2.1	1 290	2 610	STF190RV2702g	1	206	253	2	2	30.4
	270	170	170	212	2	2	1 290	2 610	STF190RV2703g	1	203	255	2	2	30.6
190	280	200	200	214	2.1	2.1	1 480	2 920	STF190RV2801g	1	206	263	2	2	41.3
	200	250	200	200	215	1	900	2 500	STF200RV2521g	SP	210	240	1	1	22.3
270		170	170	222	2.1	2.1	1 120	2 590	STF200RV2702g	1	216	253	2	2	27.9
270		200	200	222.25	2.1	2.1	1 330	3 250	STF200RV2703g	SP	216	253	2	2	34.4
200	280	200	200	224	2.1	2.1	1 410	3 200	STF200RV2801g	1	216	263	2	2	38.3
	280	200	200	222	2.1	2.1	1 410	3 200	STF200RV2802g	1	216	263	2	2	38.6
	280	190	190	223	2.1	2.1	1 350	3 050	STF200RV2803g	1	216	263	2	2	36.4
200	280	170	170	223	2.1	2.1	1 150	2 460	STF200RV2804g	1	216	263	2	2	32.3
	280	200	200	222	2.1	2.1	1 500	3 200	STF200RV2808g	1	216	263	2	2	37.8
	290	192	192	226	2.1	2.1	1 420	3 000	STF200RV2901g	1	216	273	2	2	42.3
200	310	230	230	229	2.1	2.1	1 840	3 500	STF200RV3102g	1	216	293	2	2	63.7
	320	216	216	231	3	3	2 120	3 900	STF200RV3231g	4	218	300	4	4	69.9

Notes ⁽¹⁾ Refer to Pages D142 and D143.

"SP" indicates a special design.

Please consult with NSK for detailed specifications.

■ Bearings for Rolling Mills

Four-Row Cylindrical Roller Bearings
Bore Diameter 210 – 260 mm

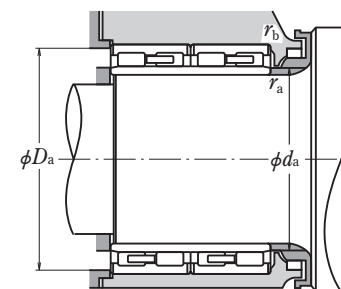
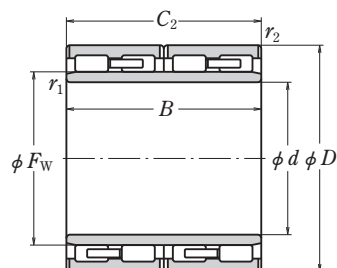

Boundary Dimensions (mm)							Basic Load Ratings (kN)		Bearing Designation	Figure ⁽¹⁾	Abutment and Fillet Dimensions (mm)				Mass (kg) approx.
<i>d</i>	<i>D</i>	<i>B</i>	<i>C</i> ₂	<i>F</i> _w	<i>r</i> ₁ min.	<i>r</i> ₂ min.	<i>C</i> _r	<i>C</i> _{0r}			<i>d</i> _a	<i>D</i> _a	<i>r</i> _a max.	<i>r</i> _b max.	
210	290	192	192	236	2.1	2.1	1 400	3 350	STF210RV2901g	1	226	273	2	2	39
	300	210	210	234	2	2	1 750	3 600	STF210RV3001g	1	224	285	2	2	47.4
219.954	310	183	183	244.5	1.5	1	1 480	3 150	STF219RV3131g	4	233	298	1.5	1	45.3
220	310	192	192	247	2.1	2.1	1 540	3 450	STF220RV3101g	1	236	293	2	2	46.1
	310	225	225	245	2.1	2.1	1 740	3 900	STF220RV3102g	1	236	293	2	2	52.9
	310	192	192	246	2.1	2.1	1 540	3 450	STF220RV3103g	1	236	293	2	2	46.2
	310	192	192	246	2.1	2.1	1 660	3 550	STF220RV3106g	1	236	293	2	2	46.0
	310	225	225	244	2.1	2.1	1 900	4 100	STF220RV3107g	1	236	293	2	2	53.0
	320	210	210	248	2.1	2.1	1 790	3 650	STF220RV3201g	1	236	302	2	2	56
	320	210	210	249	2.1	2.1	1 850	3 600	STF220RV3202g	1	236	302	2	2	54.9
	320	210	210	246	2.1	2.1	1 900	3 750	STF220RV3203g	SP	236	302	2	2	57
222.25	320.675	241.3	241.3	251	2.1	2.1	1 990	4 350	STF222RV3201g	2	238	303	2	2	65
230	330	206	206	260	2.1	2.1	1 760	3 900	STF230RV3301g	1	246	312	2	2	58.2
	330	206	206	258	2.1	2.1	1 870	3 950	STF230RV3302g	1	246	312	2	2	57.3
	340	260	260	261	3	3	2 390	5 100	STF230RV3401g	1	248	320	2.5	2.5	81
	365	250	250	266	3	3	2 310	4 300	STF230RV3601g	5	248	344	2.5	2.5	98.3
240	330	220	220	270	3	3	1 770	4 400	STF240RV3301g	1	259	310	2.5	2.5	57.7
	330	220	220	264	3	3	1 840	4 100	STF240RV3304g	3	259	310	2.5	2.5	55.1
	340	220	220	268	3	3	1 890	3 900	STF240RV3403g	1	259	320	2.5	2.5	61.7
	360	220	220	272	3	3	2 250	4 350	STF240RV3601g	2	259	340	2.5	2.5	77.8
250	340	230	230	276	4	4	2 030	4 750	STF250RV3401g	1	272	317	3	3	60.3
	350	220	220	278	3	3	1 930	4 200	STF250RV3501g	1	269	330	2.5	2.5	64.8
259.948	368	218	218	290	2.1	1.1	2 010	4 350	STF259RV3631g	4	277	354	2	1	76.7
260	355	260	260	286	2.1	2.1	2 090	5 000	STF260RV3521g	5	277	337	2	2	74.5
	370	220	220	292	3	3	2 050	4 450	STF260RV3701g	1	279	349	2.5	2.5	76
	370	220	220	290	3	3	2 220	4 450	STF260RV3704g	1	279	349	2.5	2.5	73.5
	370	260	260	290	3	3	2 720	5 950	STF260RV3721g	1	279	349	2.5	2.5	89.3
	380	280	280	294	3	3	2 820	6 250	STF260RV3801g	1	279	359	2.5	2.5	107
	400	290	290	296	4	4	3 250	6 350	STF260RV4001g	1	282	376	3	3	133

Notes (1) Refer to Pages D142 and D143.

"SP" indicates a special design.

Please consult with NSK for detailed specifications.

Air Turbine Dental Handpieces
 Pumps & Compressors
 Agricultural Machinery
 Construction Machinery
 Mining Machinery
 Railway Rolling Stock
 Papermaking Machines
 Wind Power Industry
 Steel Industry
 INDUSTRIAL SOLUTIONS

■ Bearings for Rolling Mills

Four-Row Cylindrical Roller Bearings
Bore Diameter 270 – 330 mm

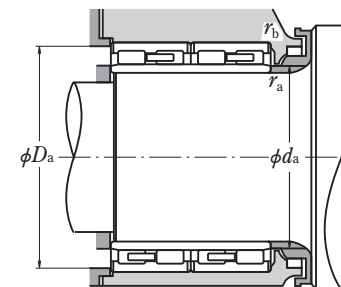
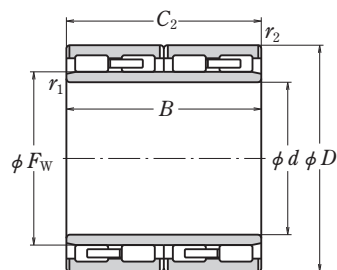

Boundary Dimensions (mm)							Basic Load Ratings (kN)		Bearing Designation	Figure ⁽¹⁾	Abutment and Fillet Dimensions (mm)				Mass (kg) approx.
d	D	B	C ₂	F _w	r ₁ min.	r ₂ min.	C _r	C _{0r}			d _a	D _a	r _a max.	r _b max.	
270	380	230	230	298	2.1	2.1	2 330	5 050	STF270RV3801g	1	287	361	2	2	83
280	390	220	220	312	3	3	2 120	4 800	STF280RV3901g	1	299	369	2.5	2.5	80.9
	390	240	240	312	3	3	2 360	5 500	STF280RV3902g	1	299	369	2.5	2.5	88.5
	390	275	275	308	3	1.1	2 860	6 450	STF280RV3903g	1	299	375	2.5	1	100
290	390	220	220	312	3	3	2 280	5 100	STF280RV3907Ag	1	299	369	2.5	2.5	81.6
	390	275	275	308	Spec.	1.1	2 860	6 450	STF280RV3911Ag	SP	298	375	2	1	99.5
	390	275	275	308	Spec.	3	2 860	6 450	STF280RV3921Ag	6	298	369	2	2.5	99.2
	400	285	285	316	3	3	3 000	6 950	STF280RV4021g	5	299	379	2.5	2.5	117
	390	234	234	320	3	3	2 270	5 600	STF290RV3901g	1	310	369	2.5	2.5	79.7
290	410	240	240	320	3	3	2 570	5 450	STF290RV4101g	1	310	389	2.5	2.5	99
	410	240	240	321	3	3	2 600	5 250	STF290RV4102g	1	310	389	2.5	2.5	97.1
	420	300	300	327	3	3	3 300	7 500	STF290RV4201g	1	310	398	2.5	2.5	138
	390	234	234	320	3	3	2 270	5 600	STF290RV3901g	1	310	369	2.5	2.5	79.7
300	400	300	300	328	2	2	2 720	6 900	STF300RV4021g	5	316	383	2	2	103
	420	240	240	332	3	3	2 670	5 750	STF300RV4201g	1	320	398	2.5	2.5	101
	420	300	300	332	3	3	3 200	7 200	STF300RV4204Ag	3	320	398	2.5	2.5	127
300	420	300	300	332	Spec.	1.5	3 550	8 350	STF300RV4216g	SP	319	403	2	1.5	132
	420	300	300	332	2	2	3 200	7 200	STF300RV4221g	5	316	402	2	2	128
310	420	300	300	338	3	3	3 300	8 050	STF310RV4201g	1	330	398	2.5	2.5	119
	430	240	240	344.5	3	3	2 610	5 950	STF310RV4301g	1	330	408	2.5	2.5	107
320	440	240	240	351	4	4	2 490	5 350	STF320RV4401g	1	343	415	3	3	104
	450	240	240	358	3	3	2 760	6 150	STF320RV4501g	1	340	428	2.5	2.5	120
	450	240	240	355	3	3	2 710	5 750	STF320RV4502g	1	340	428	2.5	2.5	117
320	460	340	340	360	3	3	3 850	8 700	STF320RV4601g	3	340	438	2.5	2.5	184
	460	240	240	364	3	3	2 820	6 100	STF320RV4621g	5	340	438	2.5	2.5	131
	480	350	350	364	4	1.5	4 850	10 500	STF320RV4811g	8	343	462	3	1.5	232
330	430	230	230	358	3	3	2 340	5 850	STF330RV4301g	1	350	408	2.5	2.5	86.3
	440	200	200	360	3	3	2 160	4 750	STF330RV4401g	3	350	418	2.5	2.5	83.8
	460	340	340	365	4	4	3 550	8 650	STF330RV4601g	1	353	435	3	3	174
	460	340	340	365	4	2.5	4 150	9 750	STF330RV4611g	SP	353	439	3	2	172

Notes ⁽¹⁾ Refer to Pages D142 and D143.

"SP" indicates a special design.

Please consult with NSK for detailed specifications.

■ Bearings for Rolling Mills

Four-Row Cylindrical Roller Bearings
Bore Diameter 340 – 400 mm

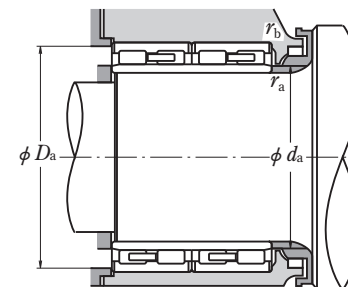
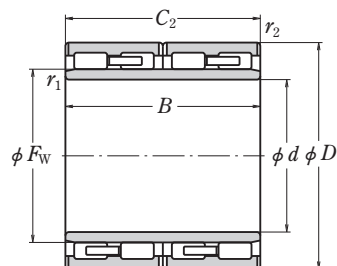

Boundary Dimensions (mm)							Basic Load Ratings (kN)		Bearing Designation	Fig-ure ⁽¹⁾	Abutment and Fillet Dimensions (mm)				Mass (kg) approx.
<i>d</i>	<i>D</i>	<i>B</i>	<i>C</i> ₂	<i>F</i> _w	<i>r</i> ₁ min.	<i>r</i> ₂ min.	<i>C</i> _r	<i>C</i> _{0r}			<i>d</i> _a	<i>D</i> _a	<i>r</i> _a max.	<i>r</i> _b max.	
340	450	250	250	371	3	3	2 720	6 750	STF340RV4501g	1	361	428	2.5	2.5	108
	450	250	250	368	3	3	2 720	6 750		3	361	428	2.5	2.5	108
	480	350	350	378	4	4	4 050	9 400		1	364	454	3	3	198
	480	350	350	378	Spec.	1.5	4 600	11 100	STF340RV4812Eg	1	355	462	2.9	1.5	208
	490	300	300	379	5	5	3 750	8 200		1	368	460	4	4	186
345	480	350	350	376	3	3	4 400	10 300	STF345RV4821g	6	366	457	2.5	2.5	190
350	500	380	380	389	5	5	4 850	11 100	STF350RV5021g	6	378	470	4	4	237
360	480	290	290	394	3	3	3 250	8 300	STF360RV4801g	1	381	457	2.5	2.5	146
	500	250	250	394	3	3	3 450	7 250		5	381	477	2.5	2.5	146
	510	370	370	400	4	4	4 500	10 100		1	384	484	3	3	234
370	480	250	250	401	3	3	2 830	7 350	STF370RV4801g	1	391	457	2.5	2.5	116
	520	380	380	409	4	2	6 000	14 400		SP	394	500	3	2	263
	520	380	380	409	Spec.	1.5	5 600	13 300		SP	393	501	3	1.5	252
	540	400	400	415	4	4	5 250	12 000		1	394	513	3	3	311
380	500	290	290	414	3	3	3 350	8 800	STF380RV5001g	1	401	477	2.5	2.5	153
	520	290	290	418	4	4	3 750	8 850		1	404	493	3	3	181
	520	280	280	417	4	4	3 650	8 450		1	404	493	3	3	174
	540	340	340	424	5	5	4 700	10 900	STF380RV5431g	4	408	509	4	4	259
	540	400	400	424	5	5	5 050	12 000		3	408	509	4	4	280
	540	400	400	422	5	2	6 000	14 400		8	408	520	4	2	305
	540	400	400	424	5	2	5 750	13 800		SP	408	520	4	2	294
390	510	290	290	424	3	3	3 400	9 000	STF390RV5101g	1	412	487	2.5	2.5	156
	550	400	400	434	5	5	5 150	12 400		6	419	519	4	4	303
400	520	250	250	432	4	4	3 000	7 700	STF400RV5202g	3	425	493	3	3	136
	550	300	300	441	4	4	4 150	9 750		1	425	523	3	3	212
	560	400	400	446	5	5	5 650	13 600		8	429	529	4	4	308
	560	410	410	445	5	2	6 550	16 500	STF400RV5613g	8M	429	539	4	2	315
	560	400	400	446	5	5	4 750	11 300		6	429	529	4	4	304
	560	410	410	445	5	2	6 550	16 500		8	429	539	4	2	315

Notes ⁽¹⁾ Refer to Pages D142 and D143.

"M" indicates a bearing designed for oil mist lubrication.

"SP" indicates a special design.

Please consult with NSK for detailed specifications.

Air Turbine
Dental
Handpieces

Pumps &
Compressors

Agricultural
Machinery

Construction
Machinery

Mining
Machinery

Railway
Rolling Stock

Papermaking
Machines

Wind Power
Industry

Steel Industry

INDUSTRY
SOLUTIONS

■ Bearings for Rolling Mills

Four-Row Cylindrical Roller Bearings
Bore Diameter 406.4 – 500 mm

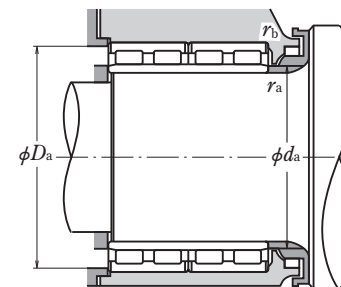
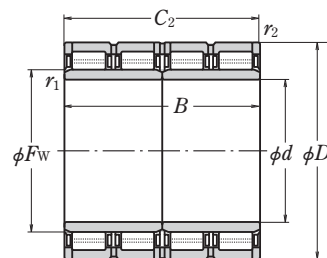

Boundary Dimensions (mm)							Basic Load Ratings (kN)		Bearing Designation	Figure ⁽¹⁾	Abutment and Fillet Dimensions (mm)				Mass (kg) approx.	
d	D	B	C ₂	F _w	r ₁ min.	r ₂ min.	C _r	C _{0r}			d _a	D _a	r _a max.	r _b max.		
406.4	609.6	304.8	304.8	460	5	5	4 650	9 150	STF406RV6001g	1	435	577	4	4	307	
410	600	440	440	460	5	5	7 350	16 600	STF410RV6011g	8	439	568	4	4	438	
420	560	280	280	457	4	4	3 800	9 250	STF420RV5601g	1	445	533	3	3	190	
	560	400	400	458	4	4	4 950	13 000	STF420RV5602g	6	445	533	3	3	270	
	600	440	440	470	5	2	7 100	17 200	STF420RV6011g	8	449	579	4	4	419	
	600	440	440	465	5	5	7 300	17 200	STF420RV6012g	8	449	568	4	4	402	
430	591	420	420	476	4	4	6 350	16 100	STF430RV5911g	8	455	563	3	3	347	
	591	420	420	476	4	4	5 200	13 400	STF430RV5921g	5	455	563	3	3	347	
440	620	450	450	487	5	5	7 350	17 800	STF440RV6213g	8	470	588	4	4	430	
	620	450	450	487	Spec.	3	8 100	19 700	STF440RV6215g	8	466	594	3	2.5	433	
	620	450	450	490	4	4	7 450	19 000	STF440RV6221g	5	466	591	3	3	430	
450	630	450	450	500	4	4	6 950	17 500	STF450RV6321g	5	476	601	3	3	440	
	460	620	400	400	506	4	4	5 500	14 700	STF460RV6201g	1	486	591	3	3	347
		620	400	400	502	4	4	6 400	16 600	STF460RV6211g	8	486	591	3	3	358
620		460	460	502	4	4	7 100	19 100	STF460RV6212g	8M	486	591	3	3	412	
460	650	470	470	509	6	3	8 400	20 900	STF460RV6511g	8	496	624	5	2.5	514	
	650	470	470	509	4	3	8 600	21 200	STF460RV6513g	8	486	624	3	2.5	501	
	670	500	500	522	6	6	8 900	22 700	STF460RV6721g	7	496	631	5	5	596	
470	660	470	470	519	4	4	8 450	20 800	STF470RV6611g	8	496	631	3	3	505	
	480	680	420	420	528	Spec.	3	8 350	19 000	STF480RV6814g	8	508	653	3.5	2.5	490
		680	500	500	532	4	3	9 400	23 500	STF480RV6815g	8	506	653	3	2.5	586
680		500	500	534	5	5	9 000	23 100	STF480RV6801g	7	510	646	4	4	610	
480	680	500	500	534	5	5	9 000	23 100	STF480RV6811g	8	510	646	4	4	610	
	700	400	400	538	6	6	7 650	17 400	STF480RV7031g	9	517	660	5	5	538	
500	670	450	450	540	Spec.	4	7 750	20 000	STF500RV6713g	8	529	640	3.5	3	446	
	670	450	450	540	5	5	8 300	22 300	STF500RV6712Eg	SP	531	637	4	4	464	
	680	420	405	550	5	5	6 700	17 600	STF500RV6812g	8	531	646	4	4	451	

Notes ⁽¹⁾ Refer to Pages D142 and D143.

"M" indicates a bearing designed for oil mist lubrication.

"SP" indicates a special design.

Please consult with NSK for detailed specifications.

■ Bearings for Rolling Mills

Four-Row Cylindrical Roller Bearings
Bore Diameter 500 – 610 mm

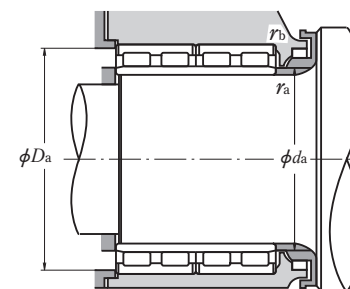
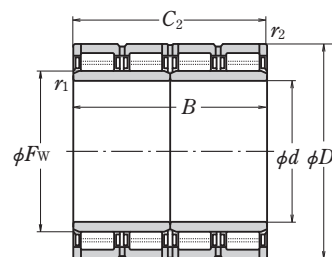

Boundary Dimensions (mm)							Basic Load Ratings (kN)		Bearing Designation	Fig-ure ⁽¹⁾	Abutment and Fillet Dimensions (mm)				Mass (kg) approx.
d	D	B	C ₂	F _w	r ₁ min.	r ₂ min.	C _r	C _{0r}			d _a	D _a	r _a max.	r _b max.	
500	690	510	510	550	5	5	8 850	23 900	STF500RV6913g	8M	531	656	4	4	480
	690	510	510	552	5	5	9 000	24 600		7	531	656	4	4	580
	700	515	515	554	5	5	9 100	23 800		7	531	666	4	4	622
	710	480	480	558	5	5	8 500	21 200	STF500RV7111g	8	531	676	4	4	632
	720	530	530	560	6	6	9 950	25 300		8	537	680	5	5	782
	720	530	530	568	6	6	10 100	25 900		8M	537	680	5	5	722
510	670	320	320	554	5	5	4 950	12 700	STF510RV6701g	1	541	637	4	4	298
	680	500	500	560	5	5	8 950	25 700		8	541	646	4	4	514
520	735	535	535	574.5	5	5	10 400	26 300	STF520RV7331g	9	551	700	4	4	750
	735	535	535	574.5	5	5	10 800	27 500		8M	551	700	4	4	733
530	780	570	570	601	6	6	11 800	29 200	STF530RV7811g	8M	568	738	5	5	960
	780	570	570	595	6	6	11 800	29 200		8	568	738	5	5	960
536.176	762.03	558.8	558.8	600	5	5	10 800	28 800	STF536RV7631g	9	568	727	4	4	849
	762.03	558.8	558.8	598	Spec.	4	11 600	30 000		SP	568	731	5.8	3	849
550	740	510	510	602	5	5	9 150	25 700	STF550RV7411Ag	8M	582	705	4	4	648
	740	510	510	600	Spec.	2	10 100	27 600		8	580	716	3.5	2	632
560	800	600	600	620	6	6	12 400	31 500	STF560RV8011g	8	598	758	5	5	1 020
	820	600	600	625	Spec.	6	14 100	34 000		8	595	778	4.5	5	1 100
570	815	594	594	628	6	6	13 200	32 000	STF570RV8113g	8	608	773	5	5	1 010
	815	594	594	628	6	6	13 700	33 500		8	608	773	5	5	960
571.1	812.97	594	594	636	6	5	13 200	34 500	STF571RV8111g	8	610	777	5	4	947
600	820	575	575	660	Spec.	3	12 900	35 500	STF600RV8212Eg	SP	629	790	5.5	2.5	931
	850	600	600	664	5	5	14 600	37 500		8M	633	813	4	4	1 110
	870	640	640	682	7.5	4	15 700	40 000		8M	645	836	6	3	1 320
	870	640	640	672	7.5	4	15 700	40 000		8	645	836	6	3	1 320
	870	640	640	669	5	5	15 700	40 000		8M	633	833	4	4	1 310
610	850	570	570	670	6	5	12 600	33 000	STF610RV8511g	8	649	813	5	4	1 040
	870	660	660	680	6	6	15 400	41 500		8	649	827	5	5	1 330

Notes ⁽¹⁾ Refer to Pages D142 and D143.

"M" indicates a bearing designed for oil mist lubrication.

"SP" indicates a special design.

Please consult with NSK for detailed specifications.

Air Turbine Dental Handpieces
 Pumps & Compressors
 Agricultural Machinery
 Construction Machinery
 Mining Machinery
 Railway Rolling Stock
 Papermaking Machines
 Wind Power Industry
 Steel Industry
 INDUSTRIAL SOLUTIONS

■ Bearings for Rolling Mills

Four-Row Cylindrical Roller Bearings
Bore Diameter 628 – 750 mm

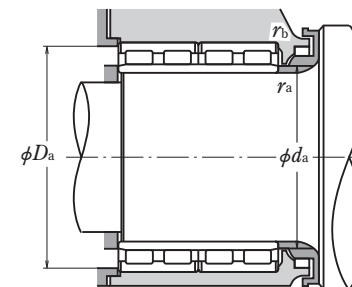
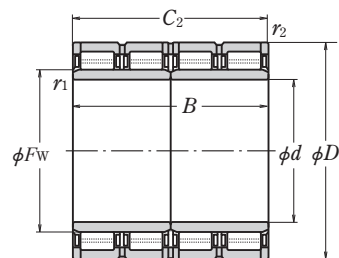

Boundary Dimensions (mm)							Basic Load Ratings (kN)		Bearing Designation	Figure ⁽¹⁾	Abutment and Fillet Dimensions (mm)				Mass (kg) approx.
d	D	B	C ₂	F _w	r ₁ min.	r ₂ min.	C _r	C _{0r}			d _a	D _a	r _a max.	r _b max.	
628	922	600	600	702	6	5	15 600	37 000	STF628RV9211g	8	668	883	5	4	1 390
634.5	901.87	674	674	705	7.5	4	16 200	43 500	STF634RV9031g	9	680	868	6	3	1 440
	901.87	674	674	705	5	4	17 000	44 500	STF634RV9011g	8M	668	868	4	3	1 410
640	870	610	610	697	6	3	14 200	40 000	STF640RV8711g	8M	680	839	5	2.5	1 100
	880	600	600	700	6	6	14 200	38 000	STF640RV8812g	8	680	836	5	5	1 110
650	900	650	650	710	Spec.	5	16 000	42 000	STF650RV9011g	8	688	862	4.5	4	1 280
	920	670	670	723	7.5	7.5	16 200	44 000	STF650RV9212g	8	696	870	6	6	1 470
	920	690	690	723	7.5	7.5	16 600	45 000	STF650RV9211g	8	696	870	6	6	1 520
660	930	660	660	728	6	6	17 000	44 000	STF660RV9311g	8	700	885	5	5	1 440
680	980	640	640	760	Spec.	4	17 500	43 500	STF680RV9811g	8	727	944	6	3	1 630
690	960	670	670	760	7.5	7.5	17 400	47 000	STF690RV9611g	8	737	909	6	6	1 520
	980	715	715	767.5	7.5	7.5	17 900	48 000	STF690RV9831g	9	737	929	6	6	1 790
	980	750	750	766	7.5	7.5	19 200	53 000	STF690RV9832g	9M	737	929	6	6	1 880
700	980	750	750	766	7.5	7.5	19 200	53 000	STF690RV9812g	8	737	929	6	6	1 880
	980	750	750	766	7.5	7.5	19 200	53 000	STF690RV9813g	8M	737	929	6	6	1 860
700	930	620	620	763	6	6	12 900	38 000	STF700RV9311g	8	741	885	5	5	1 200
	930	620	620	763	6	6	14 800	43 000	STF700RV9313g	8	741	885	5	5	1 180
	980	700	700	774	6	6	18 000	48 500	STF700RV9813g	8	741	934	5	5	1 680
	980	700	700	774	6	6	17 800	49 000	STF700RV9821g	7	741	934	5	5	1 720
710	1000	715	715	787.5	7.5	7.5	18 700	50 500	STF710RV1011g	8	757	948	6	6	1 840
725	1000	700	700	796	6	6	18 200	51 000	STF725RV1011g	8	767	954	5	5	1 670
	1000	700	700	790	Spec.	4	19 000	51 500	STF725RV1012g	8	763	964	4.5	3	1 700
	1000	700	700	796	6	6	17 700	49 500	STF725RV1021g	7	767	954	5	5	1 670
730	960	620	620	790	6	3	15 000	44 500	STF730RV9611g	8	772	928	5	2.5	1 250
	1030	750	750	809	6	6	20 700	56 500	STF730RV1011g	8	772	983	5	5	2 050
750	1000	670	670	813	6	6	16 800	49 500	STF750RV1011g	8	792	954	5	5	1 520
	1000	670	670	813	Spec.	3	17 500	50 000	STF750RV1013g	8	798	967	6	2.5	1 490

Notes ⁽¹⁾ Refer to Pages D142 and D143.
"M" indicates a bearing designed for oil mist lubrication.

Air Turbine Dental Handpieces
 Pumps & Compressors
 Agricultural Machinery
 Construction Machinery
 Mining Machinery
 Railway Rolling Stock
 Papermaking Machines
 Wind Power Industry
Steel Industry
 INDUSTRY SOLUTIONS

■ Bearings for Rolling Mills

Four-Row Cylindrical Roller Bearings
Bore Diameter 755 – 850 mm

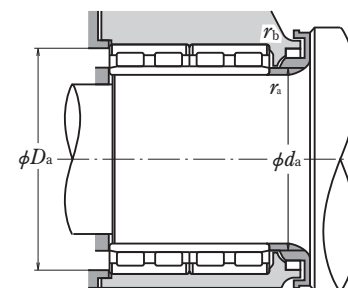
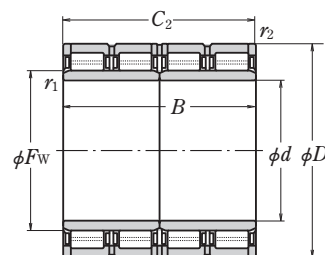

Boundary Dimensions (mm)							Basic Load Ratings (kN)		Bearing Designation	Figure ⁽¹⁾	Abutment and Fillet Dimensions (mm)				Mass (kg) approx.
d	D	B	C ₂	F _w	r ₁ min.	r ₂ min.	C _r	C _{0r}			d _a	D _a	r _a max.	r _b max.	
755	1 070	750	750	837	7.5	7.5	21 700	58 500	STF755RV1011g	8	803	1 017	6	6	2 230
760	1 030	750	750	834	7.5	7.5	18 200	53 500	STF760RV1031g	9	808	978	6	6	1 880
	1 030	750	750	828	7.5	7.5	20 800	60 000	STF760RV1012g	8M	808	978	6	6	1 850
	1 080	805	790	845	6	6	22 200	61 000	STF760RV1032Ag	9M	802	1 032	5	5	2 430
761.425	1 079.602	787.4	787.4	846	Spec.	7.5	23 900	65 500	STF761RV1012g	8	807	1 026	5.5	6	2 390
	1 079.602	787.4	787.4	845	7.5	7.5	22 200	61 000	STF761RV1032g	9	810	1 026	6	6	2 390
770	1 075	770	770	847	7.5	7.5	23 100	63 500	STF770RV1011g	8M	819	1 022	6	6	2 220
780	1 070	780	780	853	6	6	22 800	64 500	STF780RV1013g	8	823	1 023	5	5	2 140
800	1 080	700	700	878	6	3	19 100	56 000	STF800RV1013g	8	843	1 045	5	2.5	1 920
	1 080	700	700	878	6	3	19 600	58 000	STF800RV1011g	8	843	1 045	5	2.5	1 910
	1 080	750	750	880	6	6	19 200	56 500	STF800RV1012g	8	843	1 032	5	5	2 050
	1 080	750	750	880	6	6	18 700	56 500	STF800RV1032g	9	843	1 032	5	5	2 050
820	1 100	745	720	892	6	3	19 700	58 500	STF820RV1132g	SP	863	1 065	5	2.5	2 000
	1 100	745	720	892	6	6	20 100	59 000	STF820RV1119g	8M	863	1 052	5	5	1 990
	1 130	650	650	891	Spec.	6	20 300	53 000	STF820RV11112g	8	867	1 081	5.5	5	2 000
840	1 130	800	800	903	7.5	7.5	22 900	66 500	STF820RV1117g	8M	870	1 076	6	6	2 510
	1 130	825	800	903	7.5	7.5	22 900	66 500	STF820RV1134g	SP	870	1 076	6	6	2 530
	1 160	840	840	911	7.5	7.5	25 600	72 000	STF820RV1111Ag	8	870	1 105	6	6	2 900
840	1 160	840	840	920	2	7.5	24 900	71 000	STF840RV1111g	8M	866	1 105	2	6	2 790
	850	1 150	840	840	928	7.5	4	23 300	68 500	STF850RV1114g	8	900	1 111	6	3
1 150		840	840	928	7.5	8	25 600	77 500	STF850RV1115g	8	900	1 093	6	6.5	2 600
1 180		650	650	945	7.5	7.5	19 600	53 000	STF850RV1133g	9	900	1 125	6	6	2 260
850	1 180	850	850	940	7.5	7.5	24 600	72 000	STF850RV1111g	8M	900	1 125	6	6	2 850
	1 180	875	850	940	7.5	7.5	24 600	72 000	STF850RV1112Ag	8M	900	1 125	6	6	2 880

Notes ⁽¹⁾ Refer to Pages D142 and D143.
 "M" indicates a bearing designed for oil mist lubrication.
 "SP" indicates a special design.
 Please consult with NSK for detailed specifications.

Air Turbine
Dental
Handpieces

Pumps &
Compressors

Agricultural
Machinery

Construction
Machinery

Mining
Machinery

Railway
Rolling Stock

Papermaking
Machines

Wind Power
Industry

Steel Industry

Air Turbine
Dental
Handpieces

Pumps &
Compressors

Agricultural
Machinery

Construction
Machinery

Mining
Machinery

Railway
Rolling Stock

Papermaking
Machines

Wind Power
Industry

Steel Industry

INDUSTRY
SOLUTIONS

■ Bearings for Rolling Mills

Four-Row Cylindrical Roller Bearings
Bore Diameter 860 – 1348.95 mm

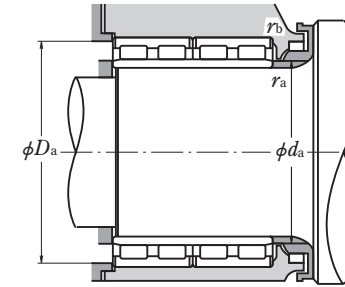
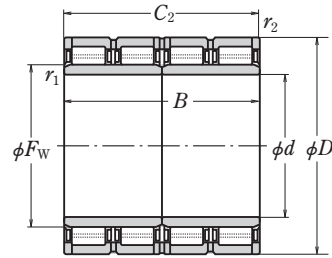

d	Boundary Dimensions (mm)						Basic Load Ratings (kN)		Bearing Designation	Figure ⁽¹⁾	Abutment and Fillet Dimensions (mm)				Mass (kg) approx.
	D	B	C ₂	F _w	r ₁ min.	r ₂ min.	C _r	C _{0r}			d _a	D _a	r _a max.	r _b max.	
860	1 130	670	670	934	6	6	18 400	56 500	STF860RV1132g	9	904	1 081	5	5	1 780
	1 160	735	710	940	7.5	4	20 400	60 000	STF860RV1133g	9	910	1 121	6	3	2 200
865 870 880	1 180	750	750	945.3	Spec.	7.5	23 800	67 000	STF865RV1111g	8	915	1 125	6	6	2 480
	1 145	705	685	940	9.5	6	20 500	61 000	STF870RV1111g	8	929	1 096	8	5	1 970
	1 230	850	850	970	7.5	7.5	29 100	81 000	STF880RV1211g	8	931	1 174	6	6	3 240
900	1 220	810	800	981	7.5	6	25 900	74 500	STF900RV1216g	8	951	1 170	6	5	2 790
	1 220	840	840	989	7.5	4	26 800	80 000	STF900RV1212g	8	951	1 179	6	3	2 950
	1 230	895	870	985	7.7	7.5	25 800	76 000	STF900RV1211g	8M	951	1 174	6	6	3 200
	1 280	930	930	1 000	7.5	7.5	32 000	89 500	STF900RV1213g	8	951	1 223	6	6	3 990
920	1 280	930	930	1 000	7.5	7.5	33 000	93 000	STF900RV1217g	8	951	1 223	6	6	4 010
	1 280	865	865	1 015	7.5	7.5	28 000	80 000	STF920RV1211Ag	8M	972	1 223	6	6	3 510
950	1 330	950	950	1 053	Spec.	9	33 500	97 000	STF950RV1314g	8	1 008	1 266	7.5	7.5	4 240
	1 360	1 000	1 000	1 075	9.5	5	37 500	108 000	STF950RV1311g	8	1 010	1 313	8	4	4 910
1 120	1 580	1 150	1 150	1 255	9.5	9.5	43 500	134 500	STF1120RV1511g	8	1 184	1 509	8	8	7 400
1 270	1 602	850	850	1 350	7.5	7.5	32 000	103 000	STF1270RV1612g	SP	1 329	1 538	6	6	4 130
1 300	1 655	890	880	1 391	7.5	7.5	34 000	110 500	STF1300RV1612g	SP	1 359	1 590	6	6	4 710
1 348.95	1 745	1 010	1 000	1 466	11.4	7.5	42 500	134 000	STF1348RV1711g	SP	1 423	1 678	9.5	6	6 240

Notes ⁽¹⁾ Refer to Pages D142 and D143.
 "M" indicates a bearing designed for oil mist lubrication.
 "SP" indicates a special design.
 Please consult with NSK for detailed specifications.

Air Turbine
Dental
Handpieces

Pumps &
Compressors

Agricultural
Machinery

Construction
Machinery

Mining
Machinery

Railway
Rolling Stock

Papermaking
Machines

Wind Power
Industry

Steel Industry

INDUSTRY SOLUTIONS

Air Turbine
Dental
Handpieces

Pumps &
Compressors

Agricultural
Machinery

Construction
Machinery

Mining
Machinery

Railway
Rolling Stock

Papermaking
Machines

Wind Power
Industry

Steel Industry

INDUSTRY SOLUTIONS

■ Bearings for Rolling Mills

Four-Row Cylindrical Roller Bearings
Bore Diameter 110.417 – 633.333 mm

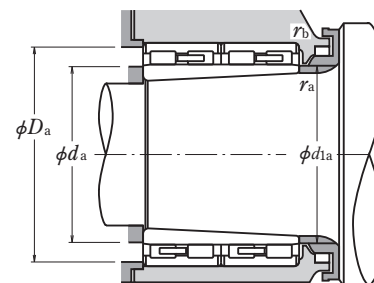
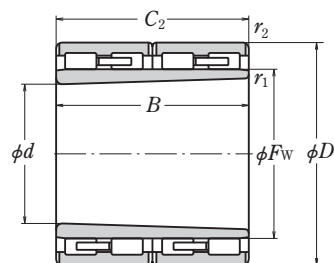

Boundary Dimensions (mm)							Basic Load Ratings (kN)		Bearing Designation	Figure ⁽¹⁾	Abutment and Fillet Dimensions (mm)					Mass (kg) approx.
<i>d</i>	<i>D</i>	<i>B</i>	<i>C</i> ₂	<i>F</i> _w	<i>r</i> ₁ min.	<i>r</i> ₂ min.	<i>C</i> _r	<i>C</i> _{0r}			<i>d</i> _a	<i>d</i> _{1a}	<i>D</i> _a	<i>r</i> _a max.	<i>r</i> _b max.	
110.417	180	115	115	136	1	1	490	840	STF120RVK1801g	10	118	128	171	1	1	10
151.5	230	168	168	180	1	1	1 040	2 170	STF165RVK2331g	11	160	174	220	1	1	23.5
179.75	260	175	168	212	1.1	2	1 140	2 600	STF193RVK2602g	10	190	205	245	1	2	25.1
180	260	175	168	212	1.1	2	1 140	2 600	STF194RVK2602g	10	191	206	245	1	2	25
181.5	260	168	168	209	1	2	1 140	2 600	STF195RVK2602g	10	191	205	245	1	2	24.2
235.367	360	268	268	278	1.5	1.5	2 770	6 000	STF257RVK3631g	11	249	272	344	1.5	1.5	92.9
266.25	400	285	285	312	2	2	3 200	7 500	STF290RVK4031g	11	281	305	383	2	2	118
356.667	550	400	400	434	5	5	5 450	13 300	STF390RVK5531g	12	385	419	519	4	4	328
	550	400	400	431.9	3	2.5	5 450	13 300	STF390RVK5532g	12	378	412	527	2.5	2	328
412.335	650	488	488	494.5	3	4	8 900	21 100	STF453RVK6521g	SP	434	476	621	2.5	3	603
485	740	540	540	580	5	5	10 100	26 800	STF530RVK7431g	13	516	561	705	4	4	823
633.333	960	680	680	745.8	7.5	7.5	18 100	47 000	STF690RVK9632g	13	679	737	909	6	6	1 720

Notes ⁽¹⁾ Refer to Pages D142 and D143.
"SP" indicates a special design.
Please consult with NSK for detailed specifications.

Air Turbine Dental Handpieces

Pumps & Compressors

Agricultural Machinery

Construction Machinery

Mining Machinery

Railway Rolling Stock

Papermaking Machines

Wind Power Industry

Steel Industry

Air Turbine Dental Handpieces

Pumps & Compressors

Agricultural Machinery

Construction Machinery

Mining Machinery

Railway Rolling Stock

Papermaking Machines

Wind Power Industry

Steel Industry

INDUSTRY SOLUTIONS

Backing Bearings for Multi-Roll Rolling Cluster Mills

- Benefits**
- ① Higher reliability and longer operating life prevent unexpected downtime
 - ② Lower maintenance costs
 - ③ Smoother rolling of backing bearing roll improves plate-making precision.

1. Operating conditions

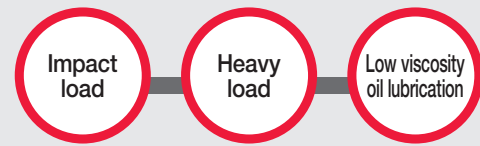

E.g. Sendzimir Mill

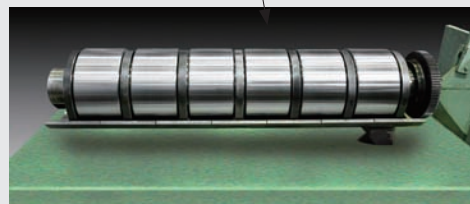

Backing bearings of a roll assemble unit



Backing bearings

2. Problems

Typical problems with backing bearings

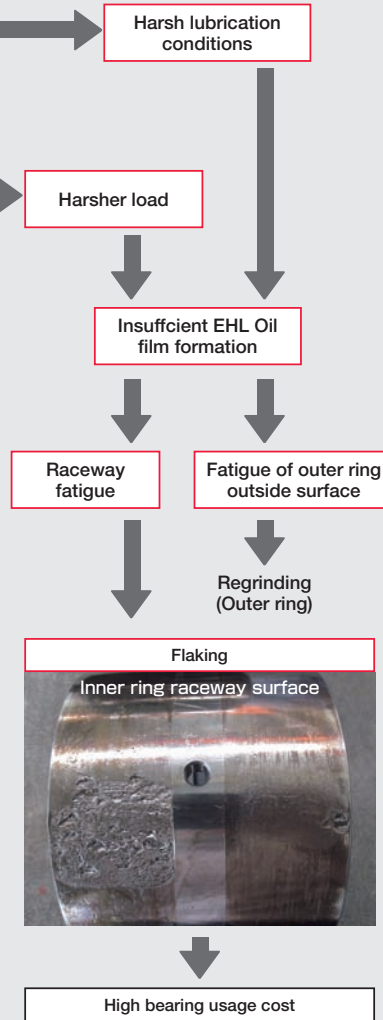

3. Countermeasures

Features Super-TF™ Backing Bearings

- Improved performance and durability under harsh load conditions and poor oil-film formation
- Outer ring: optimized hardness for regrinding and ring thickness for strength
- Inner ring: adoption of Super TF steel results in longer life even under poor lubrication
- Sealed Type (2U): Strong sealing maintains optimized internal pressure under oil mist or oil-air lubrication.

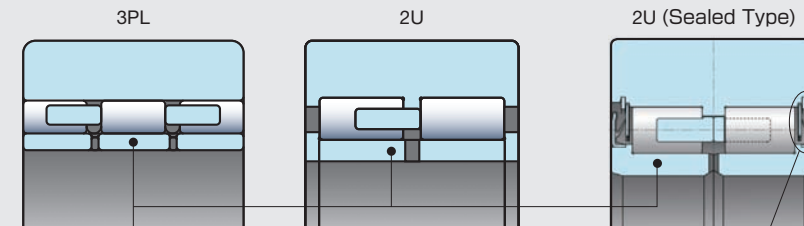

Adoption of Super-TF Material

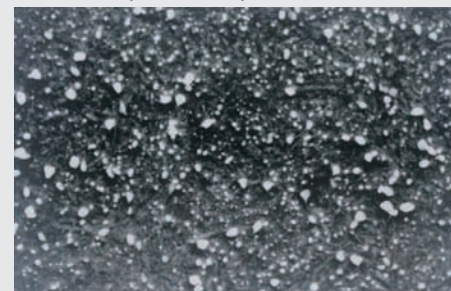

Distribution of carbides and carbonitrides in a Super-TF bearing. (x 4000 magnification).



Designations Pages D170 to D173

Super-TF Material Pages A258 to A261

Note (*1): Photo courtesy of Nippon Steel & Sumikin Stainless Steel Corporation.

■ Backing Bearings for Multi-Roll Rolling Cluster Mills

Typical Backing Bearings for Multi-Roll Rolling Mills

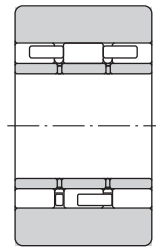

3PL
Figure 1

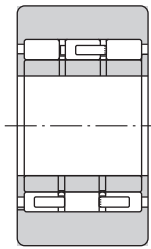

3U
Figure 2

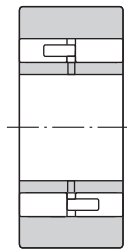

2PL
Figure 3

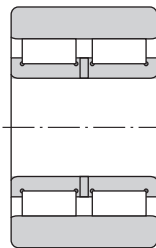

2L
Figure 4

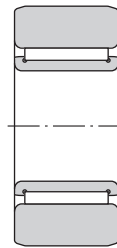

S
Figure 5

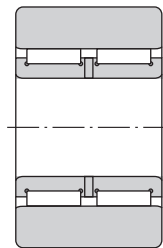

2S
Figure 6

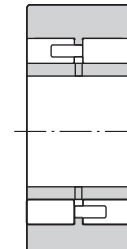

2U
Figure 7

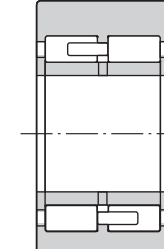

2U
Figure 8

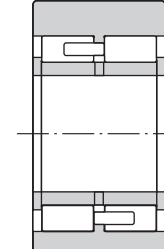

2U
Figure 9

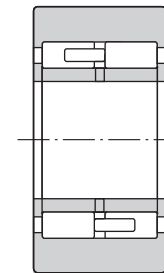

2U
Figure 10

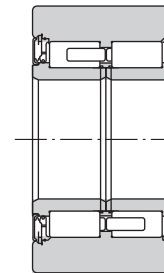

2U (Sealed Types)
Figure 11

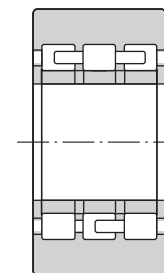

3U
Figure 12

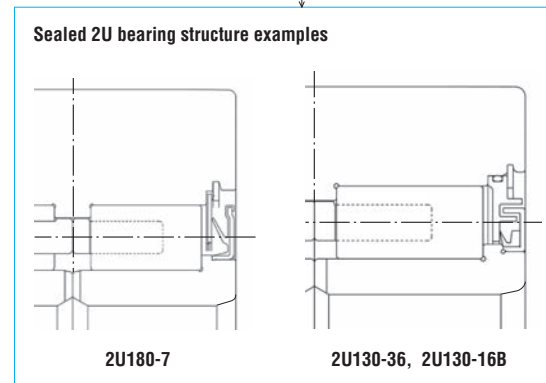

Air Turbine
Dental
Handpieces

Pumps &
Compressors

Agricultural
Machinery

Construction
Machinery

Mining
Machinery

Railway
Rolling Stock

Papermaking
Machines

Wind Power
Industry

Steel Industry

INDUSTRY
SOLUTIONS

Air Turbine
Dental
Handpieces

Pumps &
Compressors

Agricultural
Machinery

Construction
Machinery

Mining
Machinery

Railway
Rolling Stock

Papermaking
Machines

Wind Power
Industry

Steel Industry

INDUSTRY
SOLUTIONS

Backing Bearings for Multi-Roll Rolling Cluster Mills

Bore Diameter 31.75 – 120 mm

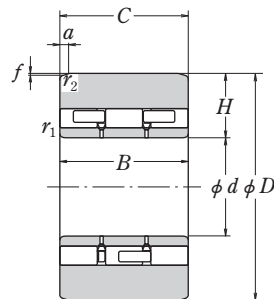

d	Boundary Dimensions (mm)				Basic Load Ratings (kN)		Permissible Radial Load Pu (kN) approx.	Bearing Designation	Figure ⁽²⁾	Outer Ring Edge Bevel (mm)		Radial Thickness When Delivered (mm)		Mass (kg) approx.	
	D	B	C	r ₁ min.	r ₂	C _r				C _{0r} ⁽¹⁾	a	f	H		
31.75	76.2	46.23	45.85	1	0.8	94.5	174	91.8	2S31Z-5	6	—	—	22.2	0 to +0.010	1.3
	50	120	80	80	1.5	1.5	257	385	147	2U50-4	9	6.5	0.042	34.976	±0.010
55	120	85	85	1	1.5	305	435	113	*2U50-4g3	9	6.5	0.042	34.984	±0.010	5.3
	120	26	26	1.6	1.6	74.5	142	90.2	2U50-6	9	6.5	0.042	34.984	±0.010	5.3
60	120	26	26	1.6	1.6	74.5	142	90.2	*2U50-6g3	9	6.5	0.042	34.984	±0.010	5.3
	120	52.2	52	1.6	1.6	159	375	185	S55-2	5	—	—	32.5	-0.025 to -0.010	1.7
62	120	52.2	52	1.6	1.6	159	375	185	*S55-2g5	5	—	—	32.5	-0.025 to -0.010	1.7
	120	52.2	52	1.6	1.6	159	375	185	S55-1	5	7	0.041	32.485	-0.010 to +0.005	3.4
70	120	52.2	52	1	1	186	298	115	S55-1g5	5	7	0.041	32.485	-0.010 to +0.005	3.4
	160	95	95	1.1	1.5	400	590	290	2L55-1	4	5	0.036	32.5	0 to +0.010	3.2
90	155	90	90	1.5	1	355	530	247	2U60-4	9	6.5	0.042	49.984	±0.010	11.5
	155	110	110	1.5	1	405	620	297	2U62-1	10	6	0.036	46.484	±0.010	9.9
100	160	90	90	1.1	1	410	745	303	3U62-1	2	6	0.036	46.484	±0.010	12.1
	220	95	95	1.1	2	590	880	347	3PL70-1	1	6	0.035	45	-0.048 to -0.018	10.7
110	220	95	95	1.1	2	590	880	347	2U90-18	8	6	0.105	64.982	±0.010	20.8
	220.02	96	94	1.5	1.5	520	730	333	*STF2U90-18g4	8	8	0.047	65	-0.010 to 0	20.5
120	220	120	119	1	3	685	1 020	411	2U90-13	8	21	0.086	65	-0.015 to 0	26.0
	220	122	119	1	3	685	1 020	410	2U90-11	8SP	21	0.086	65	-0.015 to 0	27.0
100	220	120	120	1	2	675	1 260	494	2U90-17	8SP	21	0.086	65	-0.015 to 0	27.0
	220	130	130	1	2	680	1 090	499	3U90-1	2	6	0.105	64.98	0 to +0.010	27.2
110	230	100	100	2.5	2	645	990	322	3U90-4	2SP	6	0.105	64.982	±0.010	28.7
	225	80	80	2	1.5	535	925	366	2U90-9	10SP	12	0.07	69.98	±0.010	24.4
115	225	120	119	2	3	550	1 000	586	2PL100-3	3	7.6	0.045	62.47	0 to +0.010	18.4
	225	120	120	2	2	715	1 350	542	2U100-14	8	12	0.07	62.5	±0.010	27.2
120	260	130	130	2	2	950	1 580	617	*2U100-14g3	8	12	0.07	62.5	±0.010	27.2
	280	165	165	2.5	2	1 120	1 880	818	3PL100-1A	1	8	0.093	62.47	0 to +0.010	27.5
115	260	140	140	1.1	2	940	1 660	613	2U100-15	10SP	12	0.07	79.97	±0.010	41.5
	280	165	165	2.5	2	1 120	1 880	818	3U110-4	2	12	0.072	84.965	±0.010	60.2
120	280	165	165	2.5	2	1 190	2 060	802	3U115-3	2	12	0.209	72.47	±0.010	42.1
	300	160	160	2	2	1 180	1 960	847	2U120-15	9	12	0.072	79.965	±0.010	58.0
115	350	165	165	2.5	2	1 370	2 220	1 140	3U120-4	2SP	12	0.07	89.966	±0.010	66.7
	350	165	165	2.5	2	1 370	2 220	1 140	2U120-14	9	12	0.072	114.965	±0.010	98.5

Notes ⁽¹⁾ These basic load ratings are not the limiting load. C_{0r} is for reference.

⁽²⁾ Refer to Pages D168 and D169.

"SP" indicates a special design.

Remarks Ensure that outer ring strength (permissible radial load: Pu) is sufficient when using the outer ring as a roll. Bearings marked with an asterisk (*) have a special material design. "STF" bearing designations indicate bearings with Super-TF™ material. Please consult with NSK for selection and usage of bearings.

Backing Bearings for Multi-Roll Rolling Cluster Mills

Bore Diameter 130 – 180 mm

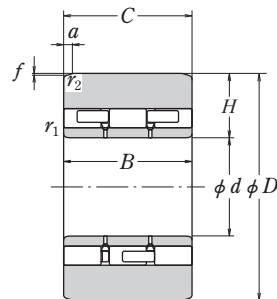

d	Boundary Dimensions (mm)				Basic Load Ratings (kN)		Permissible Radial Load Pu (kN) approx.	Bearing Designation	Figure ⁽²⁾	Outer Ring Edge Bevel (mm)		Radial Thickness When Delivered (mm)		Mass (kg) approx.	
	D	B	C	r ₁ min.	r ₂	C _r				C _{0r} ⁽¹⁾	a	f	H		
130	300	132	129	2	4	1 040	1 580	590	2U130-32 *2U130-32g2 *STF2U130-32g3	8SP	28.2	0.082	85	-0.015 to 0	52.3
	300.02	150	149	2	4	1 100	1 850	732	2U130-34	9SP	25	0.145	85.01	-0.015 to 0	60.9
	300	160	159.5	2	1.1	1 470	2 670	799	3PL130-2C	1	9	0.209	84.95	0 to +0.010	66.6
	300	172.64	172.64	2	4	1 580	2 930	862	*3PL130-2Cg2	1	10	0.131	84.95	0 to +0.010	71.8
	300	172.64	172.64	2	4	1 580	2 930	862	3PL130-1C 3PL130-1F	1SP	10	0.131	84.95	0 to +0.010	72
	300.02	172.64	172.64	2	3	1 580	2 930	862	*3PL130-1Fg2 *STF3PL130-1Fg3	1	25.4	0.148	84.965	-0.010 to 0	72.1
	300	172.64	172.64	2	4	1 580	2 930	862	3PL130-1Y	1	25	0.087	84.95	0 to +0.010	72
	300	172.644	172.644	2	4	1 370	2 440	854	2U130-26	9	12.7	0.2	84.955	±0.010	69.1
	300	172.644	172.644	3	4	1 240	2 150	808	2U130-36	11	25	0.15	84.955	±0.010	68.8
	300	172.64	170	2	2	1 240	2 150	800	*2U130-36g2 2U130-16B	11	30	0.05	84.95	0 to +0.030	71.2
179.984	300	172.64	171.6	2	4	1 320	2 300	866	3U130-2	12	10	0.131	84.95	0 to +0.010	69.4
	350	175	175	2.5	2	1 450	2 410	1 230	2U130-29B	9	12	0.10	109.965	±0.010	102
	406.4	224	220.66	3	3.3	1 950	3 550	1 460	2U179Z-3	11	15.9	0.093	113.205	-0.015 to 0	168
	406.43	224.25	220	3	4	2 250	4 250	1 570	2U179Z-14	11	60	0.175	113.181	±0.015	161
	406.42	171.04	171.04	2.1	4	2 060	3 800	1 220	*STF2U179Z-14gA5	1	25	0.145	113.155	-0.010 to 0	129
	406.42	171.04	171.04	2.1	4	2 060	3 800	1 220	3PL180-3B	1	25	0.145	113.155	±0.005	129
	406.42	171.04	171.04	0.6	1	1 900	3 300	1 150	2U180-3	9	25	0.145	113.16	-0.010 to 0	125
	406.42	171.04	170	2	3	1 650	2 850	1 220	*STF2U180-3g3	8	25	0.145	113.2	-0.015 to 0	124
	406.42	171.04	170	2	3	1 650	2 850	1 220	2U180-5	8	36.5	0.212	113.2	-0.015 to 0	124
	406.42	171.04	171.04	3	4	1 560	2 660	1 150	2U180-7	8	25	0.25	113.155	±0.010	123
180	406.42	176	170	2	3	1 650	2 850	1 220	*STF2U180-7g3	8	25	0.145	113.2	-0.015 to 0	128
	406.4	217	217	2.1	1.5	2 550	5 000	1 560	2U180-8 3PL180-1B	1	10	0.058	113.16	-0.012 to 0	164
	406.4	224	220	2.1	1.5	2 050	3 750	1 580	*3PL180-1Bg2 3U180-2	12	10	0.058	113.16	-0.012 to 0	162
	406.4	224	220	2.1	1.5	2 050	3 750	1 580	*3U180-2g2	12	10	0.058	113.205	-0.015 to 0	162
	406.42	224	224	2.1	1.5	2 610	5 150	1 610	3U180-3 3PL180-2A	1	10	0.058	113.155	-0.012 to 0	169
	406.42	224	224	0.6	1	2 360	4 400	1 510	*3PL180-2Ag2 2U180-4 *STF2U180-4g3	9	25	0.145	113.16	-0.010 to 0	164

Notes ⁽¹⁾ These basic load ratings are not the limiting load. C_{0r} is for reference.

⁽²⁾ Refer to Pages D168 and D169.

"SP" indicates a special design.

Remarks Ensure that outer ring strength (permissible radial load: Pu) is sufficient when using the outer ring as a roll. Bearings marked with an asterisk (*) have a special material design. "STF" bearing designations indicate bearings with Super-TF™ material. Please consult with NSK for selection and usage of bearings.

APPENDICES

Appendix Table 1	SI (International Units) System Conversion Table	E 002
Appendix Table 2	N–kgf Force Conversion Table	E 004
Appendix Table 3	kg–lb Mass Conversion Table	E 005
Appendix Table 4	°C–°F Temperature Conversion Table	E 006
Appendix Table 5	Viscosity Conversion Table	E 007
Appendix Table 6	inch–mm Conversion Table	E 008
Appendix Table 7	Hardness Conversion Table	E 010
Appendix Table 8	Physical and Mechanical Properties of Materials	E 011
Appendix Table 9	Tolerances for Shaft Diameters	E 012
Appendix Table 10	Tolerances for Housing Bore Diameters	E 014
Appendix Table 11	Values of IT Standard Tolerance Grades	E 016
Appendix Table 12	Speed Factor f_n	E 018
Appendix Table 13	Fatigue Life Factor f_h and Fatigue Life $L-L_h$	E 019
Appendix Table 14	Index of Inch Series Tapered Roller Bearings	E 020

Appendix Table 1 SI (International Units) System Conversion Table

Comparison of SI, CGS, and Engineering Units

Unit System	Units				Units					
	Length	Mass	Time	Temp.	Acceleration	Force	Stress	Pressure	Energy	Power
SI	m	kg	s	K, °C	m/s ²	N	Pa	Pa	J	W
CGS System	cm	g	s	°C	Gal	dyn	dyn/cm ²	dyn/cm ²	erg	erg/s
Engineering Unit System	m	kgf · s ² /m	s	°C	m/s ²	kgf	kgf/m ²	kgf/m ²	kgf · m	kgf · m/s

Prefixes Used in SI

Multiples	Prefix	Symbols	Multiples	Prefix	Symbols
10 ¹⁸	Exa	E	10 ⁻¹	Deci	d
10 ¹⁵	Peta	P	10 ⁻²	Centi	c
10 ¹²	Tera	T	10 ⁻³	Milli	m
10 ⁹	Giga	G	10 ⁻⁶	Micro	μ
10 ⁶	Mega	M	10 ⁻⁹	Nano	n
10 ³	Kilo	k	10 ⁻¹²	Pico	p
10 ²	Hecto	h	10 ⁻¹⁵	Femto	f
10	Deca	da	10 ⁻¹⁸	Ato	a

Conversion Factors From SI Units

Parameter	SI Units		Units Other Than SI		Conversion Factors From SI Units
	Names of Units	Symbols	Name of Units	Symbols	
Angle	Radian	rad	Degree	°	180/π
			Minute	'	10 800/π
			Second	"	648 000/π
Length	Meter	m	Micron	μ	10 ⁶
			Angstrom	Å	10 ¹⁰
Area	Square meter	m ²	Are	a	10 ⁻²
			Hectare	ha	10 ⁻⁴
Volume	Cubic meter	m ³	Liter	l, L	10 ³
			Deciliter	dl, dL	10 ⁴
Time	Second	s	Minute	min	1/60
			Hour	h	1/3 600
			Day	d	1/86 400
Frequency	Hertz	Hz	Cycle	s ⁻¹	1
Speed of Rotation	Revolution per second	s ⁻¹	Revolution per minute	rpm	60
Speed	Meter per second	m/s	Kilometer per hour	km/h	3 600/1 000
			Knot	kn	3 600/1 852
Acceleration	Meter per second per second	m/s ²	Gal	Gal	10 ²
			g	G	1/9.806 65
Mass	Kilogram	kg	Ton	t	10 ⁻³
Force	Newton	N	Kilogram-force	kgf	1/9.806 65
			Ton-force	tf	1/ (9.806 65×10 ³)
			Dyne	dyn	10 ⁵
Torque or Moment	Newton · meter	N · m	Kilogram-force meter	kgf · m	1/9.806 65
Stress	Pascal	Pa (N/m ²)	Kilogram-force per square centimeter	kgf/cm ²	1/ (9.806 65×10 ⁴)
			Kilogram-force per square millimeter	kgf/mm ²	1/ (9.806 65×10 ⁶)

Conversion Factors From SI Units (Continued)

Parameter	SI Units		Units Other Than SI		Conversion Factors From SI Units
	Names of Units	Symbols	Names of Units	Units	
Pressure	Pascal (Newton per square meter)	Pa (N/m ²)	Kilogram-force per square meter	kgf/m ²	1/9.806 65
			Water Column	mH ₂ O	1/ (9.806 65×10 ³)
			Mercury Column	mmHg	760/ (1.013 25×10 ⁵)
			Torr	Torr	760/ (1.013 25×10 ⁵)
			Bar	bar	10 ⁻⁵
			Atmosphere	atm	1/ (1.013 25×10 ⁵)
Energy	Joule (Newton · meter)	J (N · m)	Erg	erg	10 ⁷
			Calorie (International)	cal _{IT}	1/4.186 8
			Kilogram-force meter	kgf · m	1/9.806 65
			Kilowatt hour	kW · h	1/ (3.6×10 ⁶)
			French horsepower hour	PS · h	≈ 3.776 72×10 ⁻⁷
Work	Watt (Joule per second)	W (J/s)	Kilogram-force meter per second	kgf · m/s	1/9.806 65
			Kilocalorie per hour	kcal/h	1/1.163
			French horsepower	PS	≈ 1/735.498 8
Viscosity, Viscosity Index	Pascal second	Pa · s	Poise	P	10
Kinematic Viscosity, Kinematic Viscosity Index	Square meter per second	m ² /s	Stokes	St	10 ⁴
			Centistokes	cSt	10 ⁶
Temperature	Kelvin, Degree celsius	K, °C	Degree	°C	(See note ⁽¹⁾)
Electric Current, Magnetomotive Force	Ampere	A	Ampere	A	1
Voltage, Electromotive Force	Volt	V	(Watts per ampere)	(W/A)	1
Magnetic Field Strength	Ampere per meter	A/m	Oersted	Oe	4π/10 ³
Magnetic Flux Density	Tesla	T	Gauss	Gs	10 ⁴
			Gamma	γ	10 ⁹
Electrical Resistance	Ohm	Ω	(Volts per ampere)	(V/A)	1

Note ⁽¹⁾ The conversion from TK into θ °C is θ = T - 273.15 but ΔT = Δθ for temperature differences. Note that, ΔT and Δθ represent temperature differences measured using the Kelvin and Celsius scales respectively.

Remarks Names or symbols in parentheses () are equivalent to those directly above them or on their left. Example conversion 1 N = 1 / 9.806 65 kgf

Appendix Table 2 N-kgf Force Conversion Table

[Using this table] To convert between units, find the figure in the shaded column that corresponds to the number in the unit you wish to convert. Then, look to the appropriate column on the right or left in the same row for the converted value. For example, from this table 10 N = 1.0197 kgf, while 10 kgf = 98.066 N.

1 N=0.1019716 kgf
1 kgf=9.80665 N

N		kgf	N		kgf	N		kgf
9.8066	1	0.1020	333.43	34	3.4670	657.05	67	6.8321
19.613	2	0.2039	343.23	35	3.5690	666.85	68	6.9341
29.420	3	0.3059	353.04	36	3.6710	676.66	69	7.0360
39.227	4	0.4079	362.85	37	3.7729	686.47	70	7.1380
49.033	5	0.5099	372.65	38	3.8749	696.27	71	7.2400
58.840	6	0.6118	382.46	39	3.9769	706.08	72	7.3420
68.647	7	0.7138	392.27	40	4.0789	715.89	73	7.4439
78.453	8	0.8158	402.07	41	4.1808	725.69	74	7.5459
88.260	9	0.9177	411.88	42	4.2828	735.50	75	7.6479
98.066	10	1.0197	421.69	43	4.3848	745.31	76	7.7498
107.87	11	1.1217	431.49	44	4.4868	755.11	77	7.8518
117.68	12	1.2237	441.30	45	4.5887	764.92	78	7.9538
127.49	13	1.3256	451.11	46	4.6907	774.73	79	8.0558
137.29	14	1.4276	460.91	47	4.7927	784.53	80	8.1577
147.10	15	1.5296	470.72	48	4.8946	794.34	81	8.2597
156.91	16	1.6315	480.53	49	4.9966	804.15	82	8.3617
166.71	17	1.7335	490.33	50	5.0986	813.95	83	8.4636
176.52	18	1.8355	500.14	51	5.2006	823.76	84	8.5656
186.33	19	1.9375	509.95	52	5.3025	833.57	85	8.6676
196.13	20	2.0394	519.75	53	5.4045	843.37	86	8.7696
205.94	21	2.1414	529.56	54	5.5065	853.18	87	8.8715
215.75	22	2.2434	539.37	55	5.6084	862.99	88	8.9735
225.55	23	2.3453	549.17	56	5.7104	872.79	89	9.0755
235.36	24	2.4473	558.98	57	5.8124	882.60	90	9.1774
245.17	25	2.5493	568.79	58	5.9144	892.41	91	9.2794
254.97	26	2.6513	578.59	59	6.0163	902.21	92	9.3814
264.78	27	2.7532	588.40	60	6.1183	912.02	93	9.4834
274.59	28	2.8552	598.21	61	6.2203	921.83	94	9.5853
284.39	29	2.9572	608.01	62	6.3222	931.63	95	9.6873
294.20	30	3.0591	617.82	63	6.4242	941.44	96	9.7893
304.01	31	3.1611	627.63	64	6.5262	951.25	97	9.8912
313.81	32	3.2631	637.43	65	6.6282	961.05	98	9.9932
323.62	33	3.3651	647.24	66	6.7301	970.86	99	10.095

Appendix Table 3 kg-lb Mass Conversion Table

[Using this table] To convert between units, find the figure in the shaded column that corresponds to the number in the unit you wish to convert. Then, look to the appropriate column on the right or left in the same row for the converted value. For example, from this table 10 kg = 22.046 lb, while 10 lb = 4.536 kg.

1 kg=2.2046226 lb
1 lb=0.45359237 kg

kg		lb	kg		lb	kg		lb
0.454	1	2.205	15.422	34	74.957	30.391	67	147.71
0.907	2	4.409	15.876	35	77.162	30.844	68	149.91
1.361	3	6.614	16.329	36	79.366	31.298	69	152.12
1.814	4	8.818	16.783	37	81.571	31.751	70	154.32
2.268	5	11.023	17.237	38	83.776	32.205	71	156.53
2.722	6	13.228	17.690	39	85.980	32.659	72	158.73
3.175	7	15.432	18.144	40	88.185	33.112	73	160.94
3.629	8	17.637	18.597	41	90.390	33.566	74	163.14
4.082	9	19.842	19.051	42	92.594	34.019	75	165.35
4.536	10	22.046	19.504	43	94.799	34.473	76	167.55
4.990	11	24.251	19.958	44	97.003	34.927	77	169.76
5.443	12	26.455	20.412	45	99.208	35.380	78	171.96
5.897	13	28.660	20.865	46	101.41	35.834	79	174.17
6.350	14	30.865	21.319	47	103.62	36.287	80	176.37
6.804	15	33.069	21.772	48	105.82	36.741	81	178.57
7.257	16	35.274	22.226	49	108.03	37.195	82	180.78
7.711	17	37.479	22.680	50	110.23	37.648	83	182.98
8.165	18	39.683	23.133	51	112.44	38.102	84	185.19
8.618	19	41.888	23.587	52	114.64	38.555	85	187.39
9.072	20	44.092	24.040	53	116.84	39.009	86	189.60
9.525	21	46.297	24.494	54	119.05	39.463	87	191.80
9.979	22	48.502	24.948	55	121.25	39.916	88	194.01
10.433	23	50.706	25.401	56	123.46	40.370	89	196.21
10.886	24	52.911	25.855	57	125.66	40.823	90	198.42
11.340	25	55.116	26.308	58	127.87	41.277	91	200.62
11.793	26	57.320	26.762	59	130.07	41.730	92	202.83
12.247	27	59.525	27.216	60	132.28	42.184	93	205.03
12.701	28	61.729	27.669	61	134.48	42.638	94	207.23
13.154	29	63.934	28.123	62	136.69	43.091	95	209.44
13.608	30	66.139	28.576	63	138.89	43.545	96	211.64
14.061	31	68.343	29.030	64	141.10	43.998	97	213.85
14.515	32	70.548	29.484	65	143.30	44.452	98	216.05
14.969	33	72.753	29.937	66	145.51	44.906	99	218.26

Appendix Table 4 °C-°F Temperature Conversion Table

[Using this table] To convert between units, find the figure in the shaded column that corresponds to the number in the unit you wish to convert. Then, look to the appropriate column on the right or left in the same row for the converted value. For example, from this table 38 °C= 100.4 °F, while 38 °F= 3.3 °C.

$$C = \frac{5}{9}(F - 32)$$

$$F = 32 + \frac{9}{5}C$$

°C			°F			°C			°F			°C			°F		
-73.3	-100	-148.0	0.0	32	89.6	21.7	71	159.8	43.3	110	230	21.7	71	159.8	43.3	110	230
-62.2	-80	-112.0	0.6	33	91.4	22.2	72	161.6	46.1	115	239	22.2	72	161.6	46.1	115	239
-51.1	-60	-76.0	1.1	34	93.2	22.8	73	163.4	48.9	120	248	22.8	73	163.4	48.9	120	248
-40.0	-40	-40.0	1.7	35	95.0	23.3	74	165.2	51.7	125	257	23.3	74	165.2	51.7	125	257
-34.4	-30	-22.0	2.2	36	96.8	23.9	75	167.0	54.4	130	266	23.9	75	167.0	54.4	130	266
-28.9	-20	-4.0	2.8	37	98.6	24.4	76	168.8	57.2	135	275	24.4	76	168.8	57.2	135	275
-23.3	-10	14.0	3.3	38	100.4	25.0	77	170.6	60.0	140	284	25.0	77	170.6	60.0	140	284
-17.8	0	32.0	3.9	39	102.2	25.6	78	172.4	65.6	150	302	25.6	78	172.4	65.6	150	302
-17.2	1	33.8	4.4	40	104.0	26.1	79	174.2	71.1	160	320	26.1	79	174.2	71.1	160	320
-16.7	2	35.6	5.0	41	105.8	26.7	80	176.0	76.7	170	338	26.7	80	176.0	76.7	170	338
-16.1	3	37.4	5.6	42	107.6	27.2	81	177.8	82.2	180	356	27.2	81	177.8	82.2	180	356
-15.6	4	39.2	6.1	43	109.4	27.8	82	179.6	87.8	190	374	27.8	82	179.6	87.8	190	374
-15.0	5	41.0	6.7	44	111.2	28.3	83	181.4	93.3	200	392	28.3	83	181.4	93.3	200	392
-14.4	6	42.8	7.2	45	113.0	28.9	84	183.2	98.9	210	410	28.9	84	183.2	98.9	210	410
-13.9	7	44.6	7.8	46	114.8	29.4	85	185.0	104.4	220	428	29.4	85	185.0	104.4	220	428
-13.3	8	46.4	8.3	47	116.6	30.0	86	186.8	110.0	230	446	30.0	86	186.8	110.0	230	446
-12.8	9	48.2	8.9	48	118.4	30.6	87	188.6	115.6	240	464	30.6	87	188.6	115.6	240	464
-12.2	10	50.0	9.4	49	120.2	31.1	88	190.4	121.1	250	482	31.1	88	190.4	121.1	250	482
-11.7	11	51.8	10.0	50	122.0	31.7	89	192.2	148.9	300	572	31.7	89	192.2	148.9	300	572
-11.1	12	53.6	10.6	51	123.8	32.2	90	194.0	176.7	350	662	32.2	90	194.0	176.7	350	662
-10.6	13	55.4	11.1	52	125.6	32.8	91	195.8	204	400	752	32.8	91	195.8	204	400	752
-10.0	14	57.2	11.7	53	127.4	33.3	92	197.6	232	450	842	33.3	92	197.6	232	450	842
-9.4	15	59.0	12.2	54	129.2	33.9	93	199.4	260	500	932	33.9	93	199.4	260	500	932
-8.9	16	60.8	12.8	55	131.0	34.4	94	201.2	288	550	1022	34.4	94	201.2	288	550	1022
-8.3	17	62.6	13.3	56	132.8	35.0	95	203.0	316	600	1112	35.0	95	203.0	316	600	1112
-7.8	18	64.4	13.9	57	134.6	35.6	96	204.8	343	650	1202	35.6	96	204.8	343	650	1202
-7.2	19	66.2	14.4	58	136.4	36.1	97	206.6	371	700	1292	36.1	97	206.6	371	700	1292
-6.7	20	68.0	15.0	59	138.2	36.7	98	208.4	399	750	1382	36.7	98	208.4	399	750	1382
-6.1	21	69.8	15.6	60	140.0	37.2	99	210.2	427	800	1472	37.2	99	210.2	427	800	1472
-5.6	22	71.6	16.1	61	141.8	37.8	100	212.0	454	850	1562	37.8	100	212.0	454	850	1562
-5.0	23	73.4	16.7	62	143.6	38.3	101	213.8	482	900	1652	38.3	101	213.8	482	900	1652
-4.4	24	75.2	17.2	63	145.4	38.9	102	215.6	510	950	1742	38.9	102	215.6	510	950	1742
-3.9	25	77.0	17.8	64	147.2	39.4	103	217.4	538	1000	1832	39.4	103	217.4	538	1000	1832
-3.3	26	78.8	18.3	65	149.0	40.0	104	219.2	593	1100	2012	40.0	104	219.2	593	1100	2012
-2.8	27	80.6	18.9	66	150.8	40.6	105	221.0	649	1200	2192	40.6	105	221.0	649	1200	2192
-2.2	28	82.4	19.4	67	152.6	41.1	106	222.8	704	1300	2372	41.1	106	222.8	704	1300	2372
-1.7	29	84.2	20.0	68	154.4	41.7	107	224.6	760	1400	2552	41.7	107	224.6	760	1400	2552
-1.1	30	86.0	20.6	69	156.2	42.2	108	226.4	816	1500	2732	42.2	108	226.4	816	1500	2732
-0.6	31	87.8	21.1	70	158.0	42.8	109	228.2	871	1600	2912	42.8	109	228.2	871	1600	2912

Appendix Table 5 Viscosity Conversion Table

Kinematic Viscosity mm ² /s	Saybolt Universal SUS (sec)		No.1 Type Redwood R (sec)		Engler E (degree)	Kinematic Viscosity mm ² /s	Saybolt Universal SUS (sec)		No.1 Type Redwood R (sec)		Engler E (degree)
	100°F	210°F	50°C	100°C			100°F	210°F	50°C	100°C	
2	32.6	32.8	30.8	31.2	1.14	35	163	164	144	147	4.70
3	36.0	36.3	33.3	33.7	1.22	36	168	170	148	151	4.83
4	39.1	39.4	35.9	36.5	1.31	37	172	173	153	155	4.96
5	42.3	42.6	38.5	39.1	1.40	38	177	178	156	159	5.08
6	45.5	45.8	41.1	41.7	1.48	39	181	183	160	164	5.21
7	48.7	49.0	43.7	44.3	1.56	40	186	187	164	168	5.34
8	52.0	52.4	46.3	47.0	1.65	41	190	192	168	172	5.47
9	55.4	55.8	49.1	50.0	1.75	42	195	196	172	176	5.59
10	58.8	59.2	52.1	52.9	1.84	43	199	201	176	180	5.72
11	62.3	62.7	55.1	56.0	1.93	44	204	205	180	185	5.85
12	65.9	66.4	58.2	59.1	2.02	45	208	210	184	189	5.98
13	69.6	70.1	61.4	62.3	2.12	46	213	215	188	193	6.11
14	73.4	73.9	64.7	65.6	2.22	47	218	219	193	197	6.24
15	77.2	77.7	68.0	69.1	2.32	48	222	224	197	202	6.37
16	81.1	81.7	71.5	72.6	2.43	49	227	228	201	206	6.50
17	85.1	85.7	75.0	76.1	2.54	50	231	233	205	210	6.63
18	89.2	89.8	78.6	79.7	2.64	55	254	256	225	231	7.24
19	93.3	94.0	82.1	83.6	2.76	60	277	279	245	252	7.90
20	97.5	98.2	85.8	87.4	2.87	65	300	302	266	273	8.55
21	102	102	89.5	91.3	2.98	70	323	326	286	294	9.21
22	106	107	93.3	95.1	3.10	75	346	349	306	315	9.89
23	110	111	97.1	98.9	3.22	80	371	373	326	336	10.5
24	115	115	101	103	3.34	85	394	397	347	357	11.2
25	119	120	105	107	3.46	90	417	420	367	378	11.8
26	123	124	109	111	3.58	95	440	443	387	399	12.5
27	128	129	112	115	3.70	100	464	467	408	420	13.2
28	132	133	116	119	3.82	120	556	560	490	504	15.8
29	137	138	120	123	3.95	140	649	653	571	588	18.4
30	141	142	124	127	4.07	160	742	747	653	672	21.1
31	145	146	128	131	4.20	180	834	840	734	757	23.7
32	150	150	132	135	4.32	200	927	933	816	841	26.3
33	154	155	136	139	4.45	250	1 159	1 167	1 020	1 051	32.9
34	159	160	140	143	4.57	300	1 391	1 400	1 224	1 241	39.5

Remark 1mm²/s=1cSt

Appendix Table 6 inch - mm Conversion Table

1"=25.4 mm

inch	0	1	2	3	4	5	6	7	8	9	10	
Fraction Decimal	mm											
0	0.00000	0.000	25.400	50.800	76.200	101.600	127.000	152.400	177.800	203.200	228.600	254.000
1/64	0.015625	0.397	25.797	51.197	76.597	101.997	127.397	152.797	178.197	203.597	228.997	254.397
1/32	0.031250	0.794	26.194	51.594	76.994	102.394	127.794	153.194	178.594	203.994	229.394	254.794
3/64	0.046875	1.191	26.591	51.991	77.391	102.791	128.191	153.591	178.991	204.391	229.791	255.191
1/16	0.062500	1.588	26.988	52.388	77.788	103.188	128.588	153.988	179.388	204.788	230.188	255.588
5/64	0.078125	1.984	27.384	52.784	78.184	103.584	128.984	154.384	179.784	205.184	230.584	255.984
3/32	0.093750	2.381	27.781	53.181	78.581	103.981	129.381	154.781	180.181	205.581	230.981	256.381
7/64	0.109375	2.778	28.178	53.578	78.978	104.378	129.778	155.178	180.578	205.978	231.378	256.778
1/8	0.125000	3.175	28.575	53.975	79.375	104.775	130.175	155.575	180.975	206.375	231.775	257.175
9/64	0.140625	3.572	28.972	54.372	79.772	105.172	130.572	155.972	181.372	206.772	232.172	257.572
5/32	0.156250	3.969	29.369	54.769	80.169	105.569	130.969	156.369	181.769	207.169	232.569	257.969
11/64	0.171875	4.366	29.766	55.166	80.566	105.966	131.366	156.766	182.166	207.566	232.966	258.366
3/16	0.187500	4.762	30.162	55.562	80.962	106.362	131.762	157.162	182.562	207.962	233.362	258.762
13/64	0.203125	5.159	30.559	55.959	81.359	106.759	132.159	157.559	182.959	208.359	233.759	259.159
7/32	0.218750	5.556	30.956	56.356	81.756	107.156	132.556	157.956	183.356	208.756	234.156	259.556
15/64	0.234375	5.953	31.353	56.753	82.153	107.553	132.953	158.353	183.753	209.153	234.553	259.953
1/4	0.250000	6.350	31.750	57.150	82.550	107.950	133.350	158.750	184.150	209.550	234.950	260.350
17/64	0.265625	6.747	32.147	57.547	82.947	108.347	133.747	159.147	184.547	209.947	235.347	260.747
9/32	0.281250	7.144	32.544	57.944	83.344	108.744	134.144	159.544	184.944	210.344	235.744	261.144
19/64	0.296875	7.541	32.941	58.341	83.741	109.141	134.541	159.941	185.341	210.741	236.141	261.541
5/16	0.312500	7.938	33.338	58.738	84.138	109.538	134.938	160.338	185.738	211.138	236.538	261.938
21/64	0.328125	8.334	33.734	59.134	84.534	109.934	135.334	160.734	186.134	211.534	236.934	262.334
11/32	0.343750	8.731	34.131	59.531	84.931	110.331	135.731	161.131	186.531	211.931	237.331	262.731
23/64	0.359375	9.128	34.528	59.928	85.328	110.728	136.128	161.528	186.928	212.328	237.728	263.128
3/8	0.375000	9.525	34.925	60.325	85.725	111.125	136.525	161.925	187.325	212.725	238.125	263.525
25/64	0.390625	9.922	35.322	60.722	86.122	111.522	136.922	162.322	187.722	213.122	238.522	263.922
13/32	0.406250	10.319	35.719	61.119	86.519	111.919	137.319	162.719	188.119	213.519	238.919	264.319
27/64	0.421875	10.716	36.116	61.516	86.916	112.316	137.716	163.116	188.516	213.916	239.316	264.716
7/16	0.437500	11.112	36.512	61.912	87.312	112.712	138.112	163.512	188.912	214.312	239.712	265.112
29/64	0.453125	11.509	36.909	62.309	87.709	113.109	138.509	163.909	189.309	214.709	240.109	265.509
15/32	0.468750	11.906	37.306	62.706	88.106	113.506	138.906	164.306	189.706	215.106	240.506	265.906
31/64	0.484375	12.303	37.703	63.103	88.503	113.903	139.303	164.703	190.103	215.503	240.903	266.303
1/2	0.500000	12.700	38.100	63.500	88.900	114.300	139.700	165.100	190.500	215.900	241.300	266.700
33/64	0.515625	13.097	38.497	63.897	89.297	114.697	140.097	165.497	190.897	216.297	241.697	267.097
17/32	0.531250	13.494	38.894	64.294	89.694	115.094	140.494	165.894	191.294	216.694	242.094	267.494
35/64	0.546875	13.891	39.291	64.691	90.091	115.491	140.891	166.291	191.691	217.091	242.491	267.891
9/16	0.562500	14.288	39.688	65.088	90.488	115.888	141.288	166.688	192.088	217.488	242.888	268.288
37/64	0.578125	14.684	40.084	65.484	90.884	116.284	141.684	167.084	192.484	217.884	243.284	268.684
19/32	0.593750	15.081	40.481	65.881	91.281	116.681	142.081	167.481	192.881	218.281	243.681	269.081
39/64	0.609375	15.478	40.878	66.278	91.678	117.078	142.478	167.878	193.278	218.678	244.078	269.478
5/8	0.625000	15.875	41.275	66.675	92.075	117.475	142.875	168.275	193.675	219.075	244.475	269.875
41/64	0.640625	16.272	41.672	67.072	92.472	117.872	143.272	168.672	194.072	219.472	244.872	270.272
21/32	0.656250	16.669	42.069	67.469	92.869	118.269	143.669	169.069	194.469	219.869	245.269	270.669
43/64	0.671875	17.066	42.466	67.866	93.266	118.666	144.066	169.466	194.866	220.266	245.666	271.066
11/16	0.687500	17.462	42.862	68.262	93.662	119.062	144.462	169.862	195.262	220.662	246.062	271.462
45/64	0.703125	17.859	43.259	68.659	94.059	119.459	144.859	170.259	195.659	221.059	246.459	271.859
23/32	0.718750	18.256	43.656	69.056	94.456	119.856	145.256	170.656	196.056	221.456	246.856	272.256
47/64	0.734375	18.653	44.053	69.453	94.853	120.253	145.653	171.053	196.453	221.853	247.253	272.653
3/4	0.750000	19.050	44.450	69.850	95.250	120.650	146.050	171.450	196.850	222.250	247.650	273.050
49/64	0.765625	19.447	44.847	70.247	95.647	121.047	146.447	171.847	197.247	222.647	248.047	273.447
25/32	0.781250	19.844	45.244	70.644	96.044	121.444	146.844	172.244	197.644	223.044	248.444	273.844
51/64	0.796875	20.241	45.641	71.041	96.441	121.841	147.241	172.641	198.041	223.441	248.841	274.241
13/16	0.812500	20.638	46.038	71.438	96.838	122.238	147.638	173.038	198.438	223.838	249.238	274.638
53/64	0.828125	21.034	46.434	71.834	97.234	122.634	148.034	173.434	198.834	224.234	249.634	275.034
27/32	0.843750	21.431	46.831	72.231	97.631	123.031	148.431	173.831	199.231	224.631	250.031	275.431
55/64	0.859375	21.828	47.228	72.628	98.028	123.428	148.828	174.228	199.628	225.028	250.428	275.828
7/8	0.875000	22.225	47.625	73.025	98.425	123.825	149.225	174.625	200.025	225.425	250.825	276.225
57/64	0.890625	22.622	48.022	73.422	98.822	124.222	149.622	175.022	200.422	225.822	251.222	276.622
29/32	0.906250	23.019	48.419	73.819	99.219	124.619	150.019	175.419	200.819	226.219	251.619	277.019
59/64	0.921875	23.416	48.816	74.216	99.616	125.016	150.416	175.816	201.216	226.616	252.016	277.416
15/16	0.937500	23.812	49.212	74.612	100.012	125.412	150.812	176.212	201.612	227.012	252.412	277.812
61/64	0.953125	24.209	49.609	75.009	100.409	125.809	151.209	176.609	202.009	227.409	252.809	278.209
31/32	0.968750	24.606	50.006	75.406	100.806	126.206	151.606	177.006	202.406	227.806	253.206	278.606
63/64	0.984375	25.003	50.403	75.803	101.203	126.603	152.003	177.403	202.803	228.203	253.603	279.003

1"=25.4 mm

inch	11	12	13	14	15	16	17	18	19	20
Fraction Decimal	mm									
0	0.0000	279.400	304.800	330.200	355.600	381.000	406.400	431.		

Appendix Table 7 Hardness Conversion Table (Reference)

Rockwell C Scale Hardness (1 471N) (150kgf)	Vickers Hardness	Brinell Hardness		Rockwell Hardness		Shore Hardness
		Standard Ball	Tungsten Carbide Ball	A Scale Load ^{588.4N} (60kgf) Brale Indenter	B Scale Load ^{980.7N} (100kgf) 1.588 mm Ball (1/16in)	
68	940	—	—	85.6	—	97
67	900	—	—	85.0	—	95
66	865	—	—	84.5	—	92
65	832	—	739	83.9	—	91
64	800	—	722	83.4	—	88
63	772	—	705	82.8	—	87
62	746	—	688	82.3	—	85
61	720	—	670	81.8	—	83
60	697	—	654	81.2	—	81
59	674	—	634	80.7	—	80
58	653	—	615	80.1	—	78
57	633	—	595	79.6	—	76
56	613	—	577	79.0	—	75
55	595	—	560	78.5	—	74
54	577	—	543	78.0	—	72
53	560	—	525	77.4	—	71
52	544	500	512	76.8	—	69
51	528	487	496	76.3	—	68
50	513	475	481	75.9	—	67
49	498	464	469	75.2	—	66
48	484	451	455	74.7	—	64
47	471	442	443	74.1	—	63
46	458	432	432	73.6	—	62
45	446	421	421	73.1	—	60
44	434	409	409	72.5	—	58
43	423	400	400	72.0	—	57
42	412	390	390	71.5	—	56
41	402	381	381	70.9	—	55
40	392	371	371	70.4	—	54
39	382	362	362	69.9	—	52
38	372	353	353	69.4	—	51
37	363	344	344	68.9	—	50
36	354	336	336	68.4	(109.0)	49
35	345	327	327	67.9	(108.5)	48
34	336	319	319	67.4	(108.0)	47
33	327	311	311	66.8	(107.5)	46
32	318	301	301	66.3	(107.0)	44
31	310	294	294	65.8	(106.0)	43
30	302	286	286	65.3	(105.5)	42
29	294	279	279	64.7	(104.5)	41
28	286	271	271	64.3	(104.0)	41
27	279	264	264	63.8	(103.0)	40
26	272	258	258	63.3	(102.5)	38
25	266	253	253	62.8	(101.5)	38
24	260	247	247	62.4	(101.0)	37
23	254	243	243	62.0	100.0	36
22	248	237	237	61.5	99.0	35
21	243	231	231	61.0	98.5	35
20	238	226	226	60.5	97.8	34
(18)	230	219	219	—	96.7	33
(16)	222	212	212	—	95.5	32
(14)	213	203	203	—	93.9	31
(12)	204	194	194	—	92.3	29
(10)	196	187	187	—	90.7	28
(8)	188	179	179	—	89.5	27
(6)	180	171	171	—	87.1	26
(4)	173	165	165	—	85.5	25
(2)	166	158	158	—	83.5	24
(0)	160	152	152	—	81.7	24

Appendix Table 8 Physical and Mechanical Properties of Materials

Materials	Specific Gravity	Coefficient of Linear Expansion (0° to 100°C) (K ⁻¹)	Hardness (Brinell)	Young's modulus (MPa) (kgf/mm ²)	Tensile Strength (MPa) (kgf/mm ²)	Yield Point (MPa) (kgf/mm ²)	Elongation (%)
Bearing Steel (hardened)	7.83	12.5×10 ⁻⁶	650 to 740	208 000 (21 200)	1 570 to 1 960 (160 to 200)	—	—
Martensitic Stainless Steel SUS 440C	7.68	10.1×10 ⁻⁶	580	200 000 (20 400)	1 960 (200)	1 860 (190)	—
Mild Steel (C=0.12 to 0.20%)	7.86	11.6×10 ⁻⁶	100 to 130	206 000 (21 000)	373 to 471 (38 to 48)	216 to 294 (22 to 30)	24 to 36
Hard Steel (C=0.3 to 0.5%)	7.84	11.3×10 ⁻⁶	160 to 200	206 000 (21 000)	539 to 686 (55 to 70)	333 to 451 (34 to 46)	14 to 26
Austenitic Stainless Steel SUS 304	8.03	16.3×10 ⁻⁶	150	193 000 (19 700)	588 (60)	245 (25)	60
Cast Iron Gray Iron FC200	7.3	10.4×10 ⁻⁶	223	98 100 (10 000)	More than 200 (20)	—	—
Cast Iron Spheroidal graphite Iron FCD400	7.0	11.7×10 ⁻⁶	Less than 201	169 000 (17 200)	More than 400 (41)	—	More than 12
Aluminum	2.69	23.7×10 ⁻⁶	15 to 26	70 600 (7 200)	78 (8)	34 (3.5)	35
Zinc	7.14	31×10 ⁻⁶	30 to 60	92 200 (9 400)	147 (15)	—	30 to 40
Copper	8.93	16.2×10 ⁻⁶	50	123 000 (12 500)	196 (20)	69 (7)	15 to 20
Brass (Annealed)	8.5	19.1×10 ⁻⁶	45	103 000 (10 500)	294 to 343 (30 to 35)	—	65 to 75
Brass (Machined)			85 to 130		363 to 539 (37 to 55)		15 to 50

Remark The hardness of hardened bearing steel and martensitic stainless steel is usually expressed using the Rockwell C Scale, but for comparison, here it is converted into Brinell hardness.

Appendix Table 9 Tolerances

for Shaft Diameters

Units : μm

Diameter Classification (mm)		Single Plane Mean B.D. Deviation (Normal) Δd _{mp}	d6	e6	f6	g5	g6	h5	h6	h7	h8	h9	h10	js5	js6
over	incl.														
3	6	0 - 8	- 30 - 38	- 20 - 28	- 10 - 18	- 4 - 4 - 9 - 12	- 0 - 0 - 5 - 8	0 - 0 - 12 - 18	0 - 0 - 30 - 48	± 2.5	± 4				
6	10	0 - 8	- 40 - 49	- 25 - 34	- 13 - 22	- 5 - 5 - 11 - 14	0 - 0 - 6 - 9	0 - 0 - 15 - 22	0 - 0 - 36 - 58	± 3	± 4.5				
10	18	0 - 8	- 50 - 61	- 32 - 43	- 16 - 27	- 6 - 6 - 14 - 17	0 - 0 - 8 - 11	0 - 0 - 18 - 27	0 - 0 - 43 - 70	± 4	± 5.5				
18	30	0 - 10	- 65 - 78	- 40 - 53	- 20 - 33	- 7 - 7 - 16 - 20	0 - 0 - 9 - 13	0 - 0 - 21 - 33	0 - 0 - 52 - 84	± 4.5	± 6.5				
30	50	0 - 12	- 80 - 96	- 50 - 66	- 25 - 41	- 9 - 9 - 20 - 25	0 - 0 - 11 - 16	0 - 0 - 25 - 39	0 - 0 - 62 - 100	± 5.5	± 8				
50	80	0 - 15	- 100 - 119	- 60 - 79	- 30 - 49	- 10 - 10 - 23 - 29	0 - 0 - 13 - 19	0 - 0 - 30 - 46	0 - 0 - 74 - 120	± 6.5	± 9.5				
80	120	0 - 20	- 120 - 142	- 72 - 94	- 36 - 58	- 12 - 12 - 27 - 34	0 - 0 - 15 - 22	0 - 0 - 35 - 54	0 - 0 - 87 - 140	± 7.5	± 11				
120	180	0 - 25	- 145 - 170	- 85 - 110	- 43 - 68	- 14 - 14 - 32 - 39	0 - 0 - 18 - 25	0 - 0 - 40 - 63	0 - 0 - 100 - 160	± 9	± 12.5				
180	250	0 - 30	- 170 - 199	- 100 - 129	- 50 - 79	- 15 - 15 - 35 - 44	0 - 0 - 20 - 29	0 - 0 - 46 - 72	0 - 0 - 115 - 185	± 10	± 14.5				
250	315	0 - 35	- 190 - 222	- 110 - 142	- 56 - 88	- 17 - 17 - 40 - 49	0 - 0 - 23 - 32	0 - 0 - 52 - 81	0 - 0 - 130 - 210	± 11.5	± 16				
315	400	0 - 40	- 210 - 246	- 125 - 161	- 62 - 98	- 18 - 18 - 43 - 54	0 - 0 - 25 - 36	0 - 0 - 57 - 89	0 - 0 - 140 - 230	± 12.5	± 18				
400	500	0 - 45	- 230 - 270	- 135 - 175	- 68 - 108	- 20 - 20 - 47 - 60	0 - 0 - 27 - 40	0 - 0 - 63 - 97	0 - 0 - 155 - 250	± 13.5	± 20				
500	630	0 - 50	- 260 - 304	- 145 - 189	- 76 - 120	- 22 - 22 - 66	0 - 0 - 44 - 70	0 - 0 - 110 - 175	0 - 0 - 280	—	± 22				
630	800	0 - 75	- 290 - 340	- 160 - 210	- 80 - 130	- 24 - 24 - 74	0 - 0 - 50 - 80	0 - 0 - 125 - 200	0 - 0 - 320	—	± 25				
800	1 000	0 - 100	- 320 - 376	- 170 - 226	- 86 - 142	- 26 - 26 - 82	0 - 0 - 56 - 90	0 - 0 - 140 - 230	0 - 0 - 360	—	± 28				
1 000	1 250	0 - 125	- 350 - 416	- 195 - 261	- 98 - 164	- 28 - 28 - 94	0 - 0 - 66 - 105	0 - 0 - 165 - 260	0 - 0 - 420	—	± 33				
1 250	1 600	0 - 160	- 390 - 468	- 220 - 298	- 110 - 188	- 30 - 30 - 108	0 - 0 - 78 - 125	0 - 0 - 195 - 310	0 - 0 - 500	—	± 39				
1 600	2 000	0 - 200	- 430 - 522	- 240 - 332	- 120 - 212	- 32 - 32 - 124	0 - 0 - 92 - 150	0 - 0 - 230 - 370	0 - 0 - 600	—	± 46				

j5	j6	j7	k5	k6	k7	m5	m6	n6	p6	r6	r7	Diameter Classification (mm)	
												over	incl.
+ 3 - 2	+ 6 - 2	+ 8 - 4	+ 6 + 1	+ 9 + 1	+ 13 + 1	+ 9 + 4	+ 12 + 4	+ 16 + 8	+ 20 + 12	+ 23 + 15	+ 27 + 15	3	6
+ 4 - 2	+ 7 - 2	+ 10 - 5	+ 7 + 1	+ 10 + 1	+ 16 + 1	+ 12 + 6	+ 15 + 6	+ 19 + 10	+ 24 + 15	+ 28 + 19	+ 34 + 19	6	10
+ 5 - 3	+ 8 - 3	+ 12 - 6	+ 9 + 1	+ 12 + 1	+ 19 + 1	+ 15 + 7	+ 18 + 7	+ 23 + 12	+ 29 + 18	+ 34 + 23	+ 41 + 23	10	18
+ 5 - 4	+ 9 - 4	+ 13 - 8	+ 11 + 2	+ 15 + 2	+ 23 + 2	+ 17 + 8	+ 21 + 8	+ 28 + 15	+ 35 + 28	+ 41 + 28	+ 49 + 28	18	30
+ 6 - 5	+ 11 - 5	+ 15 - 10	+ 13 + 2	+ 18 + 2	+ 27 + 2	+ 20 + 9	+ 25 + 9	+ 33 + 17	+ 42 + 26	+ 50 + 34	+ 59 + 34	30	50
+ 6 - 7	+ 12 - 7	+ 18 - 12	+ 15 + 2	+ 21 + 2	+ 32 + 2	+ 24 + 11	+ 30 + 11	+ 39 + 20	+ 51 + 32	+ 60 + 41	+ 71 + 41	50	65
+ 6 - 9	+ 13 - 9	+ 20 - 15	+ 18 + 3	+ 25 + 3	+ 38 + 3	+ 28 + 13	+ 35 + 13	+ 45 + 23	+ 59 + 37	+ 73 + 51	+ 86 + 51	80	100
+ 7 - 11	+ 14 - 11	+ 22 - 18	+ 21 + 3	+ 28 + 3	+ 43 + 3	+ 33 + 15	+ 40 + 15	+ 52 + 27	+ 68 + 43	+ 88 + 63	+ 103 + 63	120	140
+ 7 - 13	+ 16 - 13	+ 25 - 21	+ 24 + 4	+ 33 + 4	+ 50 + 4	+ 37 + 17	+ 46 + 17	+ 60 + 31	+ 79 + 50	+ 90 + 80	+ 105 + 80	140	160
+ 7 - 16	± 16	± 26	+ 27 + 4	+ 36 + 4	+ 56 + 4	+ 43 + 20	+ 52 + 20	+ 66 + 34	+ 88 + 56	+ 93 + 94	+ 108 + 94	160	180
+ 7 - 18	± 18	+ 29 - 28	+ 29 + 4	+ 40 + 4	+ 61 + 4	+ 46 + 21	+ 57 + 21	+ 73 + 37	+ 98 + 62	+ 106 + 108	+ 123 + 108	180	200
+ 7 - 20	± 20	+ 31 - 32	+ 32 + 5	+ 45 + 5	+ 68 + 5	+ 50 + 23	+ 63 + 23	+ 80 + 40	+ 108 + 68	+ 126 + 126	+ 146 + 126	200	225
—	—	—	—	+ 44 0	+ 70 0	—	+ 70 + 26	+ 88 + 44	+ 122 + 78	+ 144 + 150	+ 165 + 150	250	280
—	—	—	—	+ 50 0	+ 80 0	—	+ 80 + 30	+ 100 + 50	+ 138 + 88	+ 130 + 185	+ 150 + 185	280	315
—	—	—	—	+ 56 0	+ 90 0	—	+ 90 + 34	+ 112 + 56	+ 156 + 100	+ 144 + 210	+ 165 + 210	315	355
—	—	—	—	+ 66 0	+ 105 0	—	+ 106 + 40	+ 132 + 66	+ 186 + 120	+ 150 + 326	+ 220 + 260	355	400
—	—	—	—	+ 78 0	+ 125 0	—	+ 126 + 48	+ 156 + 78	+ 218 + 140	+ 166 + 408	+ 189 + 455	400	450
—	—	—	—	+ 92 0	+ 150 0	—	+ 150 + 58	+ 184 + 92	+ 262 + 170	+ 172 + 492	+ 195 + 400	450	500
—	—	—	—	—	—	—	—	—	—	+ 194 + 150	+ 220 + 150	500	560
—	—	—	—	—	—	—	—	—	—	+ 199 + 155	+ 225 + 155	560	630
—	—	—	—	—	—	—	—	—	—	+ 225 + 175	+ 255 + 175	630	710
—	—	—	—	—	—	—	—	—	—	+ 235 + 185	+ 265 + 185	710	800
—	—	—	—	—	—	—	—	—	—	+ 266 + 210	+ 300 + 210	800	900
—	—	—	—	—	—	—	—	—	—	+ 276 + 220	+ 310 + 220	900	1 000
—	—	—	—	—	—	—	—	—	—	+ 316 + 250	+ 355 + 250	1 000	1 120
—	—	—	—	—	—	—	—	—	—	+ 326 + 260	+ 365 + 260	1 120	1 250
—	—	—	—	—	—	—	—	—	—	+ 378 + 300	+ 425 + 300	1 250	1 400
—	—	—	—	—	—	—	—	—	—	+ 408 + 330	+ 455 + 330	1 400	1 600
—	—	—	—	—	—	—	—	—	—	+ 462 + 370	+ 520 + 370	1 600	1 800
—	—	—	—	—	—	—	—	—	—	+ 492 + 400	+ 550 + 400	1 800	2 000

Appendix Table 10

Diameter Classification (mm)		Single Plane Mean O.D. Deviation (Normal) ΔD_{mp}	E6	F6	F7	G6	G7	H6	H7	H8	J6	J7	JS6	JS7
over	incl.													
10	18	0 - 8	+ 43 + 32	+ 27 + 16	+ 34 + 16	+ 17 + 6	+ 24 + 6	+ 11 0	+ 18 0	+ 27 0	+ 6 - 5	+ 10 - 8	± 5.5	± 9
18	30	0 - 9	+ 53 + 40	+ 33 + 20	+ 41 + 20	+ 20 + 7	+ 28 + 7	+ 13 0	+ 21 0	+ 33 0	+ 8 - 5	+ 12 - 9	± 6.5	± 10.5
30	50	0 - 11	+ 66 + 50	+ 41 + 25	+ 50 + 25	+ 25 + 9	+ 34 + 9	+ 16 0	+ 25 0	+ 39 0	+ 10 - 6	+ 14 - 11	± 8	± 12.5
50	80	0 - 13	+ 79 + 60	+ 49 + 30	+ 60 + 30	+ 29 + 10	+ 40 + 10	+ 19 0	+ 30 0	+ 46 0	+ 13 - 6	+ 18 - 12	± 9.5	± 15
80	120	0 - 15	+ 94 + 72	+ 58 + 36	+ 71 + 36	+ 34 + 12	+ 47 + 12	+ 22 0	+ 35 0	+ 54 0	+ 16 - 6	+ 22 - 13	± 11	± 17.5
120	150	0 - 18	+ 110 + 85	+ 68 + 43	+ 83 + 43	+ 39 + 14	+ 54 + 14	+ 25 0	+ 40 0	+ 63 0	+ 18 - 7	+ 26 - 14	± 12.5	± 20
150	180	0 - 25	+ 129 + 100	+ 79 + 50	+ 96 + 50	+ 44 + 15	+ 61 + 15	+ 29 0	+ 46 0	+ 72 0	+ 22 - 7	+ 30 - 16	± 14.5	± 23
180	250	0 - 30	+ 142 + 110	+ 88 + 56	+ 108 + 56	+ 49 + 17	+ 69 + 17	+ 32 0	+ 52 0	+ 81 0	+ 25 - 7	+ 36 - 16	± 16	± 26
250	315	0 - 35	+ 161 + 125	+ 98 + 62	+ 119 + 62	+ 54 + 18	+ 75 + 18	+ 36 0	+ 57 0	+ 89 0	+ 29 - 7	+ 39 - 18	± 18	± 28.5
315	400	0 - 40	+ 175 + 135	+ 108 + 68	+ 131 + 68	+ 60 + 20	+ 83 + 20	+ 40 0	+ 63 0	+ 97 0	+ 33 - 7	+ 43 - 20	± 20	± 31.5
400	500	0 - 45	+ 189 + 145	+ 120 + 76	+ 146 + 76	+ 66 + 22	+ 92 + 22	+ 44 0	+ 70 0	+ 110 0	—	—	± 22	± 35
500	630	0 - 50	+ 210 + 160	+ 130 + 80	+ 160 + 80	+ 74 + 24	+ 104 + 24	+ 50 0	+ 80 0	+ 125 0	—	—	± 25	± 40
630	800	0 - 75	+ 226 + 170	+ 142 + 86	+ 176 + 86	+ 82 + 26	+ 116 + 26	+ 56 0	+ 90 0	+ 140 0	—	—	± 28	± 45
800	1 000	0 - 100	+ 261 + 195	+ 164 + 98	+ 203 + 98	+ 94 + 28	+ 133 + 28	+ 66 0	+ 105 0	+ 165 0	—	—	± 33	± 52.5
1 000	1 250	0 - 125	+ 298 + 220	+ 188 + 110	+ 235 + 110	+ 108 + 30	+ 155 + 30	+ 78 0	+ 125 0	+ 195 0	—	—	± 39	± 62.5
1 250	1 600	0 - 160	+ 332 + 240	+ 212 + 120	+ 270 + 120	+ 124 + 32	+ 182 + 32	+ 92 0	+ 150 0	+ 230 0	—	—	± 46	± 75
1 600	2 000	0 - 200	+ 370 + 260	+ 240 + 130	+ 305 + 130	+ 144 + 34	+ 209 + 34	+ 110 0	+ 175 0	+ 280 0	—	—	± 55	± 87.5
2 000	2 500	0 - 250												

Tolerances for Housing Bore Diameters

Units : μm

K5	K6	K7	M5	M6	M7	N5	N6	N7	P6	P7	Diameter Classification (mm)	
											over	incl.
+ 2 - 6	+ 2 - 9	+ 6 - 12	- 4 - 12	- 4 - 15	0 - 18	- 9 - 17	- 9 - 20	- 5 - 23	- 15 - 26	- 11 - 29	10	18
+ 1 - 8	+ 2 - 11	+ 6 - 15	- 5 - 14	- 4 - 17	0 - 21	- 12 - 21	- 11 - 24	- 7 - 28	- 18 - 31	- 14 - 35	18	30
+ 2 - 9	+ 3 - 13	+ 7 - 18	- 5 - 16	- 4 - 20	0 - 25	- 13 - 24	- 12 - 28	- 8 - 33	- 21 - 37	- 17 - 42	30	50
+ 3 - 10	+ 4 - 15	+ 9 - 21	- 6 - 19	- 5 - 24	0 - 30	- 15 - 28	- 14 - 33	- 9 - 39	- 26 - 45	- 21 - 51	50	80
+ 2 - 13	+ 4 - 18	+ 10 - 25	- 8 - 23	- 6 - 28	0 - 35	- 18 - 33	- 16 - 38	- 10 - 45	- 30 - 52	- 24 - 59	80	120
+ 3 - 15	+ 4 - 21	+ 12 - 28	- 9 - 27	- 8 - 33	0 - 40	- 21 - 39	- 20 - 45	- 12 - 52	- 36 - 61	- 28 - 68	120	180
+ 2 - 18	+ 5 - 24	+ 13 - 33	- 11 - 31	- 8 - 37	0 - 46	- 25 - 45	- 22 - 51	- 14 - 60	- 41 - 70	- 33 - 79	180	250
+ 3 - 20	+ 5 - 27	+ 16 - 36	- 13 - 36	- 9 - 41	0 - 52	- 27 - 50	- 25 - 57	- 14 - 66	- 47 - 79	- 36 - 88	250	315
+ 3 - 22	+ 7 - 29	+ 17 - 40	- 14 - 39	- 10 - 46	0 - 57	- 30 - 55	- 26 - 62	- 16 - 73	- 51 - 87	- 41 - 98	315	400
+ 2 - 25	+ 8 - 32	+ 18 - 45	- 16 - 43	- 10 - 50	0 - 63	- 33 - 60	- 27 - 67	- 17 - 80	- 55 - 95	- 45 - 108	400	500
—	0 - 44	0 - 70	—	- 26 - 70	- 26 - 96	—	- 44 - 88	- 44 - 114	- 78 - 122	- 78 - 148	500	630
—	0 - 50	0 - 80	—	- 30 - 80	- 30 - 110	—	- 50 - 100	- 50 - 130	- 88 - 138	- 88 - 168	630	800
—	0 - 56	0 - 90	—	- 34 - 90	- 34 - 124	—	- 56 - 112	- 56 - 146	- 100 - 156	- 100 - 190	800	1 000
—	0 - 66	0 - 105	—	- 40 - 106	- 40 - 145	—	- 66 - 132	- 66 - 171	- 120 - 186	- 120 - 225	1 000	1 250
—	0 - 78	0 - 125	—	- 48 - 126	- 48 - 173	—	- 78 - 156	- 78 - 203	- 140 - 218	- 140 - 265	1 250	1 600
—	0 - 92	0 - 150	—	- 58 - 150	- 58 - 208	—	- 92 - 184	- 92 - 242	- 170 - 262	- 170 - 320	1 600	2 000
—	0 - 110	0 - 175	—	- 68 - 178	- 68 - 243	—	- 110 - 220	- 110 - 285	- 195 - 305	- 195 - 370	2 000	2 500

Appendix Table 11 Values of

Basic Size (mm)		Standard										
		IT1	IT2	IT3	IT4	IT5	IT6	IT7	IT8	IT9	IT10	IT11
over	incl.	Tolerances (μm)										
—	3	0.8	1.2	2	3	4	6	10	14	25	40	60
3	6	1	1.5	2.5	4	5	8	12	18	30	48	75
6	10	1	1.5	2.5	4	6	9	15	22	36	58	90
10	18	1.2	2	3	5	8	11	18	27	43	70	110
18	30	1.5	2.5	4	6	9	13	21	33	52	84	130
30	50	1.5	2.5	4	7	11	16	25	39	62	100	160
50	80	2	3	5	8	13	19	30	46	74	120	190
80	120	2.5	4	6	10	15	22	35	54	87	140	220
120	180	3.5	5	8	12	18	25	40	63	100	160	250
180	250	4.5	7	10	14	20	29	46	72	115	185	290
250	315	6	8	12	16	23	32	52	81	130	210	320
315	400	7	9	13	18	25	36	57	89	140	230	360
400	500	8	10	15	20	27	40	63	97	155	250	400
500	630	9	11	16	22	32	44	70	110	175	280	440
630	800	10	13	18	25	36	50	80	125	200	320	500
800	1 000	11	15	21	28	40	56	90	140	230	360	560
1 000	1 250	13	18	24	33	47	66	105	165	260	420	660
1 250	1 600	15	21	29	39	55	78	125	195	310	500	780
1 600	2 000	18	25	35	46	65	92	150	230	370	600	920
2 000	2 500	22	30	41	55	78	110	175	280	440	700	1 100
2 500	3 150	26	36	50	68	96	135	210	330	540	860	1 350

- Remarks**
- Standard tolerance grades IT14 to IT18 must not be used for basic sizes less than or equal to 1 mm.
 - Values for standard tolerance grades IT1 to IT5 for basic sizes over 500 mm are included for experimental use.

IT Standard Tolerance Grades

Grades							Basic Size (mm)	
IT12	IT13	IT14	IT15	IT16	IT17	IT18		
Tolerances (mm)							over	incl.
0.10	0.14	0.25	0.40	0.60	1.00	1.40	—	3
0.12	0.18	0.30	0.48	0.75	1.20	1.80	3	6
0.15	0.22	0.36	0.58	0.90	1.50	2.20	6	10
0.18	0.27	0.43	0.70	1.10	1.80	2.70	10	18
0.21	0.33	0.52	0.84	1.30	2.10	3.30	18	30
0.25	0.39	0.62	1.00	1.60	2.50	3.90	30	50
0.30	0.46	0.74	1.20	1.90	3.00	4.60	50	80
0.35	0.54	0.87	1.40	2.20	3.50	5.40	80	120
0.40	0.63	1.00	1.60	2.50	4.00	6.30	120	180
0.46	0.72	1.15	1.85	2.90	4.60	7.20	180	250
0.52	0.81	1.30	2.10	3.20	5.20	8.10	250	315
0.57	0.89	1.40	2.30	3.60	5.70	8.90	315	400
0.63	0.97	1.55	2.50	4.00	6.30	9.70	400	500
0.70	1.10	1.75	2.80	4.40	7.00	11.00	500	630
0.80	1.25	2.00	3.20	5.00	8.00	12.50	630	800
0.90	1.40	2.30	3.60	5.60	9.00	14.00	800	1 000
1.05	1.65	2.60	4.20	6.60	10.50	16.50	1 000	1 250
1.25	1.95	3.10	5.00	7.80	12.50	19.50	1 250	1 600
1.50	2.30	3.70	6.00	9.20	15.00	23.00	1 600	2 000
1.75	2.80	4.40	7.00	11.00	17.50	28.00	2 000	2 500
2.10	3.30	5.40	8.60	13.50	21.00	33.00	2 500	3 150

Appendix Table 12 Speed Factor f_n

Speed n (min ⁻¹)	Speed Factor f_n		Speed n (min ⁻¹)	Speed Factor f_n	
	Ball Bearings	Roller Bearings		Ball Bearings	Roller Bearings
10	1.49	1.44	180	0.570	0.603
11	1.45	1.39	190	0.560	0.593
12	1.41	1.36	200	0.550	0.584
13	1.37	1.33	220	0.533	0.568
14	1.34	1.30	240	0.518	0.553
15	1.30	1.27	260	0.504	0.540
16	1.28	1.25	280	0.492	0.528
17	1.25	1.22	300	0.481	0.517
18	1.23	1.20	320	0.471	0.507
19	1.21	1.18	340	0.461	0.498
20	1.19	1.17	360	0.452	0.490
21	1.17	1.15	380	0.444	0.482
22	1.15	1.13	400	0.437	0.475
23	1.13	1.12	420	0.430	0.468
24	1.12	1.10	440	0.423	0.461
25	1.10	1.09	460	0.417	0.455
26	1.09	1.08	480	0.411	0.449
27	1.07	1.07	500	0.405	0.444
28	1.06	1.05	550	0.393	0.431
29	1.05	1.04	600	0.382	0.420
30	1.04	1.03	650	0.372	0.410
31	1.02	1.02	700	0.362	0.401
32	1.01	1.01	750	0.354	0.393
33.3	1.00	1.00	800	0.347	0.385
34	0.993	0.994	850	0.340	0.378
36	0.975	0.977	900	0.333	0.372
38	0.957	0.961	950	0.327	0.366
40	0.941	0.947	1 000	0.322	0.360
42	0.926	0.933	1 050	0.317	0.355
44	0.912	0.920	1 100	0.312	0.350
46	0.898	0.908	1 150	0.307	0.346
48	0.886	0.896	1 200	0.303	0.341
50	0.874	0.885	1 250	0.299	0.337
55	0.846	0.861	1 300	0.295	0.333
60	0.822	0.838	1 400	0.288	0.326
65	0.800	0.818	1 500	0.281	0.319
70	0.781	0.800	1 600	0.275	0.313
75	0.763	0.784	1 700	0.270	0.307
80	0.747	0.769	1 800	0.265	0.302
85	0.732	0.755	1 900	0.260	0.297
90	0.718	0.742	2 000	0.255	0.293
95	0.705	0.730	2 100	0.251	0.289
100	0.693	0.719	2 200	0.247	0.285
110	0.672	0.699	2 300	0.244	0.281
120	0.652	0.681	2 400	0.240	0.277
130	0.635	0.665	2 500	0.237	0.274
140	0.620	0.650	2 600	0.234	0.271
150	0.606	0.637	2 700	0.231	0.268
160	0.593	0.625	2 800	0.228	0.265
170	0.581	0.613	2 900	0.226	0.262

Ball Bearings $f_n = (0.03 n)^{-1/3}$
 Roller Bearings $f_n = (0.03 n)^{-3/10}$

Speed n (min ⁻¹)	Speed Factor f_n		Speed n (min ⁻¹)	Speed Factor f_n	
	Ball Bearings	Roller Bearings		Ball Bearings	Roller Bearings
3 000	0.223	0.259	4 000	0.203	0.238
3 200	0.218	0.254	4 200	0.199	0.234
3 400	0.214	0.250	4 400	0.196	0.231
3 600	0.210	0.245	4 600	0.194	0.228
3 800	0.206	0.242	4 800	0.191	0.225
5 000	0.188	0.222	5 200	0.186	0.220
5 200	0.186	0.220	5 400	0.183	0.217
5 400	0.183	0.217	5 600	0.181	0.215
5 600	0.181	0.215	5 800	0.179	0.213
6 000	0.177	0.211	6 200	0.175	0.209
6 200	0.175	0.209	6 400	0.173	0.207
6 400	0.173	0.207	6 600	0.172	0.205
6 600	0.172	0.205	6 800	0.170	0.203
7 000	0.168	0.201	7 200	0.167	0.199
7 200	0.167	0.199	7 400	0.165	0.198
7 400	0.165	0.198	7 600	0.164	0.196
7 600	0.164	0.196	7 800	0.162	0.195
8 000	0.161	0.193	8 500	0.158	0.190
8 500	0.158	0.190	9 000	0.155	0.186
9 000	0.155	0.186	9 500	0.152	0.183
9 500	0.152	0.183	10 000	0.149	0.181
11 000	0.145	0.176	12 000	0.141	0.171
12 000	0.141	0.171	13 000	0.137	0.167
13 000	0.137	0.167	14 000	0.134	0.163
14 000	0.134	0.163	15 000	0.130	0.160
16 000	0.128	0.157	17 000	0.125	0.154
17 000	0.125	0.154	18 000	0.123	0.151
18 000	0.123	0.151	19 000	0.121	0.149
19 000	0.121	0.149	20 000	0.119	0.147
22 000	0.115	0.143	24 000	0.112	0.139
24 000	0.112	0.139	26 000	0.109	0.136
26 000	0.109	0.136	28 000	0.106	0.133
28 000	0.106	0.133	30 000	0.104	0.130
32 000	0.101	0.127	34 000	0.099	0.125
34 000	0.099	0.125	36 000	0.097	0.123
36 000	0.097	0.123	38 000	0.096	0.121
38 000	0.096	0.121	40 000	0.094	0.119

Appendix Table 13 Fatigue Life Factor f_h and Fatigue Life L - L_h

Ball Bearings $L = (C/P)^3 L_h = 500 f_h^3$
 Roller Bearings $L = (C/P)^{10/3} L_h = 500 f_h^{10/3}$

C/P or f_h	Ball Bearing Life		Roller Bearing Life		C/P or f_h	Ball Bearing Life		Roller Bearing Life	
	L (10 ⁶ rev)	L_h (h)	L (10 ⁶ rev)	L_h (h)		L (10 ⁶ rev)	L_h (h)	L (10 ⁶ rev)	L_h (h)
0.70	0.34	172	0.30	152	3.45	41.1	20 500	62.0	31 000
0.75	0.42	211	0.38	192	3.50	42.9	21 400	65.1	32 500
0.80	0.51	256	0.48	238	3.55	44.7	22 400	68.2	34 100
0.85	0.61	307	0.58	291	3.60	46.7	23 300	71.5	35 800
0.90	0.73	365	0.70	352	3.65	48.6	24 300	74.9	37 400
0.95	0.86	429	0.84	421	3.70	50.7	25 300	78.3	39 200
1.00	1.00	500	1.00	500	3.75	52.7	26 400	81.9	41 000
1.05	1.16	579	1.18	588	3.80	54.9	27 400	85.6	42 800
1.10	1.33	665	1.37	687	3.85	57.1	28 500	89.4	44 700
1.15	1.52	760	1.59	797	3.90	59.3	29 700	93.4	46 700
1.20	1.73	864	1.84	918	3.95	61.6	30 800	97.4	48 700
1.25	1.95	977	2.10	1 050	4.00	64.0	32 000	102	50 800
1.30	2.20	1 100	2.40	1 200	4.05	66.4	33 200	106	52 900
1.35	2.46	1 230	2.72	1 360	4.10	68.9	34 500	110	55 200
1.40	2.74	1 370	3.07	1 530	4.15	71.5	35 700	115	57 400
1.45	3.05	1 520	3.45	1 730	4.20	74.1	37 000	120	59 800
1.50	3.38	1 690	3.86	1 930	4.25	76.8	38 400	124	62 200
1.55	3.72	1 860	4.31	2 150	4.30	79.5	39 800	129	64 600
1.60	4.10	2 050	4.79	2 400	4.35	82.3	41 200	134	67 200
1.65	4.49	2 250	5.31	2 650	4.40	85.2	42 600	140	69 800
1.70	4.91	2 460	5.86	2 930	4.45	88.1	44 100	145	72 500
1.75	5.36	2 680	6.46	3 230	4.50	91.1	45 600	150	75 200
1.80	5.83	2 920	7.09	3 550	4.55	94.2	47 100	156	78 000
1.85	6.33	3 170	7.77	3 890	4.60	97.3	48 700	162	80 900
1.90	6.86	3 430	8.50	4 250	4.65	101	50 300	168	83 900
1.95	7.41	3 710	9.26	4 630	4.70	104	51 900	174	87 000
2.00	8.00	4 000	10.1	5 040	4.75	107	53 600	180	90 100
2.05	8.62	4 310	10.9	5 470	4.80	111	55 300	187	93 300
2.10	9.26	4 630	11.9	5 930	4.85	114	57 000	193	96 600
2.15	9.94	4 970	12.8	6 410	4.90	118	58 800	200	99 900
2.20	10.6	5 320	13.8	6 920	4.95	121	60 600	207	103 000
2.25	11.4	5 700	14.9	7 460	5.00	125	62 500	214	107 000
2.30	12.2	6 080	16.1	8 030	5.10	133	66 300	228	114 000
2.35	13.0	6 490	17.3	8 630	5.20	141	70 300	244	122 000
2.40	13.8	6 910	18.5	9 250	5.30	149	74 400	260	130 000
2.45	14.7	7 350	19.8	9 910	5.40	157	78 700	276	138 000
2.50	15.6	7 810	21.2	10 600	5.50	166	83 200	294	147 000
2.55	16.6	8 290	22.7	11 300	5.60	176	87 800	312	156 000
2.60	17.6	8 790	24.2	12 100	5.70	185	92 600	331	165 000
2.65	18.6	9 300	25.8	12 900	5.80	195	97 600	351	175 000
2.70	19.7	9 840	27.4	13 700	5.90	205	103 000	371	186 000
2.75	20.8	10 400	29.1	14 600	6.00	216	108 000	392	196 000
2.80	22.0	11 000	30.9	15 500	6.50	275	137 000	513	256 000
2.85	23.1	11 600	32.8	16 400	7.00	343	172 000	656	328 000
2.90	24.4	12 200	34.8	17 400	7.50	422	211 000	826	413 000
2.95	25.7	12 800	36.8	18 400	8.00	512	256 000	1 020	512 000
3.00	27.0	13 500	38.9	19 500	8.50	614	307 000	1 250	627 000
3.05	28.4	14 200	41.1	20 600	9.00	729	365 000	1 520	758 000
3.10	29.8	14 900	43.4	21 700	9.50	857	429 000	1 820	908 000
3.15	31.3	15 600	45.8	22 900	10.0	1 000	—	2 150	—
3.20	32.8	16 400	48.3	24 100	11.0	1 330	—	2 960	—
3.25	34.3	17 200	50.8	25 400	12.0	1 730	—	3 960	—
3.30	35.9	18 000	53.5	26 800	13.0	2 200	—	5 170	—
3.35	37.6	18 800	56.3	28 100	14.0	2 740	—	6 610	—
3.40	39.3	19 700	59.1	29 600	15.0	3 380	—	8 320	—

Appendix Table 14 Index of Inch Series Tapered Roller Bearings

Designation INNER RING, OUTER RING	Nominal Dimension (mm) d: I. R. (Bore Dia.) D: O. R. (Outside Dia.)	Pages
332	<i>D</i> 80.000	C214, C218, C220
336	<i>d</i> 41.275	C220
342	<i>d</i> 41.275	C220
342 S	<i>d</i> 42.875	C220
344	<i>d</i> 40.000	C218
344 A	<i>d</i> 40.000	C218
346	<i>d</i> 31.750	C214
354 A	<i>D</i> 85.000	C222
359 S	<i>d</i> 46.038	C222
362 A	<i>D</i> 88.900	C222, C224
366	<i>d</i> 50.000	C224
368	<i>d</i> 50.800	C224
368 A	<i>d</i> 50.800	C224
369 A	<i>d</i> 47.625	C222
372	<i>D</i> 100.000	C224
374	<i>D</i> 93.264	C222
376	<i>d</i> 45.000	C222
377	<i>d</i> 52.388	C224
382	<i>D</i> 98.425	C226
382 A	<i>D</i> 96.838	C226
382 S	<i>D</i> 96.838	C226
385	<i>d</i> 55.000	C226
387	<i>d</i> 57.150	C226
387 A	<i>d</i> 57.150	C226
388 A	<i>d</i> 57.531	C226
390 A	<i>d</i> 63.500	C228
394 A	<i>D</i> 110.000	C228, C230
395	<i>d</i> 63.500	C228
395 A	<i>d</i> 66.675	C230
395 S	<i>d</i> 66.675	C230
397	<i>d</i> 60.000	C228
399 A	<i>d</i> 68.262	C230
414	<i>D</i> 88.501	C218
418	<i>d</i> 38.100	C218
432	<i>D</i> 95.250	C220
432 A	<i>D</i> 95.250	C222
436	<i>d</i> 46.038	C222
438	<i>d</i> 44.450	C220
453 A	<i>D</i> 107.950	C222
453 X	<i>D</i> 104.775	C226
460	<i>d</i> 44.450	C222
462	<i>d</i> 57.150	C226
469	<i>d</i> 57.150	C226
472	<i>D</i> 120.000	C230, C232
472 A	<i>D</i> 120.000	C230
478	<i>d</i> 65.000	C230
480	<i>d</i> 68.262	C230
484	<i>d</i> 70.000	C232
492 A	<i>D</i> 133.350	C234, C236
493	<i>D</i> 136.525	C232, C234, C236
495	<i>d</i> 82.550	C234
495 A	<i>d</i> 76.200	C232
495 AX	<i>d</i> 76.200	C232
496	<i>d</i> 80.962	C234

Designation INNER RING, OUTER RING	Nominal Dimension (mm) d: I. R. (Bore Dia.) D: O. R. (Outside Dia.)	Pages
497	<i>d</i> 85.725	C236
498	<i>d</i> 84.138	C236
522	<i>D</i> 101.600	C222, C224
528	<i>d</i> 47.625	C222
529	<i>d</i> 50.800	C224
529 X	<i>d</i> 50.800	C224
532 X	<i>D</i> 107.950	C226
539	<i>d</i> 53.975	C226
552 A	<i>D</i> 123.825	C226, C228, C230
553 X	<i>D</i> 122.238	C228, C230
555 S	<i>d</i> 57.150	C226
557 S	<i>d</i> 53.975	C226
558	<i>d</i> 60.325	C228
559	<i>d</i> 63.500	C228
560	<i>d</i> 66.675	C230
560 S	<i>D</i> 68.262	C230
563	<i>D</i> 127.000	C228, C230, C232
563 X	<i>D</i> 127.000	C230
565	<i>d</i> 63.500	C228
566	<i>d</i> 69.850	C230
567	<i>d</i> 73.025	C232
567 A	<i>d</i> 71.438	C232
567 S	<i>d</i> 71.438	C232
568	<i>d</i> 73.817	C232
569	<i>d</i> 64.963	C228
570	<i>d</i> 68.262	C230
572	<i>D</i> 139.992	C232, C234
572 X	<i>D</i> 139.700	C234
575	<i>d</i> 76.200	C232
580	<i>d</i> 82.550	C234
581	<i>d</i> 80.962	C234
582	<i>d</i> 82.550	C234
590 A	<i>d</i> 76.200	C232
592	<i>D</i> 152.400	C238
592 A	<i>D</i> 152.400	C232, C236, C238
593	<i>d</i> 88.900	C236
594	<i>d</i> 95.250	C238
596	<i>d</i> 85.725	C236
597	<i>d</i> 93.662	C238
598	<i>d</i> 92.075	C238
598 A	<i>d</i> 92.075	C238
614 X	<i>D</i> 115.000	C226
622 X	<i>d</i> 55.000	C226
632	<i>D</i> 136.525	C228, C232
633	<i>D</i> 130.175	C228, C230, C232
637	<i>d</i> 60.325	C228
639	<i>d</i> 63.500	C228
643	<i>d</i> 69.850	C230
644	<i>d</i> 71.438	C232
645	<i>d</i> 71.438	C232
652	<i>D</i> 152.400	C232, C234
653	<i>D</i> 146.050	C230, C232, C234, C236
653 X	<i>D</i> 150.000	C232
655	<i>d</i> 69.850	C230

Designation INNER RING, OUTER RING	Nominal Dimension (mm) d: I. R. (Bore Dia.) D: O. R. (Outside Dia.)	Pages
657	<i>d</i> 73.025	C232
658	<i>d</i> 74.612	C232
659	<i>d</i> 76.200	C232
661	<i>d</i> 79.375	C234
663	<i>d</i> 82.550	C234
664	<i>d</i> 84.138	C236
665	<i>d</i> 85.725	C236
665 A	<i>d</i> 85.725	C236
672	<i>D</i> 168.275	C236, C238, C240
677	<i>d</i> 85.725	C236
681	<i>d</i> 92.075	C238
683	<i>d</i> 95.250	C238
685	<i>d</i> 98.425	C238
687	<i>d</i> 101.600	C240
742	<i>D</i> 150.089	C230, C234, C236
743	<i>D</i> 150.000	C234
745 A	<i>d</i> 69.850	C230
749	<i>d</i> 85.026	C236
749 A	<i>d</i> 82.550	C234
749 S	<i>d</i> 85.026	C236
750	<i>d</i> 79.375	C234
752	<i>D</i> 161.925	C234, C236
753	<i>D</i> 168.275	C234, C236
757	<i>d</i> 82.550	C234
758	<i>d</i> 85.725	C236
759	<i>d</i> 88.900	C236
760	<i>d</i> 90.488	C236
766	<i>d</i> 88.900	C236
772	<i>D</i> 180.975	C238, C240
776	<i>d</i> 95.250	C238
779	<i>d</i> 98.425	C238
780	<i>d</i> 101.600	C240
782	<i>d</i> 104.775	C240
787	<i>d</i> 104.775	C240
792	<i>D</i> 206.375	C242
795	<i>d</i> 120.650	C242
797	<i>d</i> 130.000	C242
799	<i>d</i> 128.588	C242
799 A	<i>d</i> 130.175	C242
832	<i>D</i> 168.275	C234, C236
837	<i>d</i> 76.200	C234
842	<i>d</i> 82.550	C234
843	<i>d</i> 76.200	C234
850	<i>d</i> 88.900	C236
854	<i>D</i> 190.500	C236, C238, C240
855	<i>d</i> 88.900	C236
857	<i>d</i> 92.075	C238
861	<i>d</i> 101.600	C240
864	<i>d</i> 95.250	C238
866	<i>d</i> 98.425	C238
932	<i>D</i> 212.725	C240
938	<i>d</i> 114.300	C240
1220	<i>d</i> 57.150	C210
1280	<i>d</i> 22.225	C210

Designation INNER RING, OUTER RING	Nominal Dimension (mm) d: I. R. (Bore Dia.) D: O. R. (Outside Dia.)	Pages
1328	<i>D</i> 52.388	C210
1329	<i>D</i> 53.975	C210
1380	<i>d</i> 22.225	C210
1620	<i>D</i> 66.675	C216
1680	<i>d</i> 33.338	C216
1729	<i>D</i> 56.896	C210, C212
1755	<i>d</i> 22.225	C210
1779	<i>d</i> 23.812	C212
1922	<i>D</i> 57.150	C212
1988	<i>d</i> 28.575	C212
1997 X	<i>d</i> 26.988	C212
A2047	<i>d</i> 12.000	C210
A2126	<i>D</i> 31.991	C210
2523	<i>D</i> 69.850	C214, C216
2558	<i>d</i> 30.162	C214
2559	<i>d</i> 30.162	C214
2580	<i>d</i> 31.750	C214
2582	<i>d</i> 31.750	C214
2585	<i>d</i> 33.338	C216
2631	<i>D</i> 66.421	C214
2690	<i>d</i> 29.367	C214
2720	<i>D</i> 76.200	C218
2729	<i>D</i> 76.200	C218
2735 X	<i>D</i> 73.025	C218
2788	<i>d</i> 38.100	C218
2789	<i>d</i> 39.688	C218
2820	<i>d</i> 73.025	C216
2877	<i>d</i> 34.925	C216
2924	<i>D</i> 85.000	C222
2984	<i>d</i> 46.038	C222
3120	<i>D</i> 72.626	C214, C216
3188	<i>d</i> 31.750	C214
3197	<i>d</i> 33.338	C216
3320	<i>D</i> 80.167	C218
3386	<i>d</i> 39.688	C218
3420	<i>D</i> 79.375	C216, C218
3478	<i>d</i> 34.925	C216
3479	<i>d</i> 36.512	C218
3490	<i>d</i> 38.100	C218
3525	<i>D</i> 87.312	C220
3576	<i>d</i> 41.275	C220
3578	<i>d</i> 44.450	C220
3720	<i>D</i> 93.264	C220
3730	<i>D</i> 93.264	C224
3775	<i>d</i> 50.800	C224
3780	<i>d</i> 50.800	C224
3782	<i>d</i> 44.450	C220
3820	<i>D</i> 85.725	C220
3877	<i>d</i> 41.275	C220
3920	<i>D</i> 112.712	C228, C230
3926	<i>D</i> 112.712	C226, C228
3981	<i>d</i> 58.738	C226
3982	<i>d</i> 63.500	C228
3984	<i>d</i> 66.675	C230

Designation INNER RING, OUTER RING	Nominal Dimension (mm) <i>d</i> : I. R. (Bore Dia.) <i>D</i> : O. R. (Outside Dia.)	Pages
3994	<i>d</i> 66.675	C230
A4050	<i>d</i> 12.700	C210
A4059	<i>d</i> 15.000	C210
A4138	<i>D</i> 34.988	C210
4335	<i>D</i> 90.488	C220
4388	<i>d</i> 41.275	C220
4535	<i>D</i> 104.775	C226
4595	<i>d</i> 53.975	C226
A5069	<i>d</i> 17.455	C210
A5144	<i>D</i> 36.525	C210
5335	<i>D</i> 103.188	C222
5356	<i>d</i> 44.450	C222
5535	<i>D</i> 122.238	C226,C228
5566	<i>d</i> 55.562	C226
5582	<i>d</i> 60.325	C228
5584	<i>d</i> 63.500	C228
5735	<i>D</i> 135.733	C232,C234
5760	<i>d</i> 76.200	C232
5795	<i>d</i> 77.788	C234
A6062	<i>d</i> 15.875	C210
A6067	<i>d</i> 16.993	C210
A6075	<i>d</i> 19.050	C210
A6157	<i>D</i> 39.992	C210
6220	<i>D</i> 127.000	C224,C226
6279	<i>d</i> 50.800	C224
6280	<i>d</i> 53.975	C226
6320	<i>D</i> 135.755	C228,C230
6376	<i>d</i> 60.325	C228
6379	<i>d</i> 65.088	C230
6420	<i>D</i> 149.225	C226,C230,C232
6454	<i>d</i> 69.850	C230
6455	<i>d</i> 57.150	C226
6460	<i>d</i> 73.025	C232
6461	<i>d</i> 76.200	C232
6535	<i>D</i> 161.925	C232,C234,C236
6536	<i>D</i> 161.925	C232
6559	<i>d</i> 82.550	C234
6575	<i>d</i> 76.200	C232
6576	<i>d</i> 76.200	C232
6580	<i>d</i> 88.900	C236
9121	<i>D</i> 152.400	C228,C230
9180	<i>d</i> 61.912	C228
9185	<i>d</i> 68.262	C230
9220	<i>D</i> 161.925	C232
9285	<i>d</i> 76.200	C232
9320	<i>D</i> 177.800	C234
9321	<i>D</i> 171.450	C234,C236
9378	<i>d</i> 76.200	C234
9380	<i>d</i> 76.200	C234
9385	<i>d</i> 84.138	C236
02420	<i>D</i> 68.262	C212,C214
02473	<i>d</i> 25.400	C212
02474	<i>d</i> 28.575	C212
02475	<i>d</i> 31.750	C214

Designation INNER RING, OUTER RING	Nominal Dimension (mm) <i>d</i> : I. R. (Bore Dia.) <i>D</i> : O. R. (Outside Dia.)	Pages
02820	<i>D</i> 73.025	C212,C216
02872	<i>d</i> 28.575	C212
02878	<i>d</i> 34.925	C216
03062	<i>d</i> 15.875	C210
03162	<i>D</i> 41.275	C210
05062	<i>d</i> 15.875	C210
05068	<i>d</i> 17.462	C210
05075	<i>d</i> 19.050	C210
05079	<i>d</i> 19.990	C210
05175	<i>D</i> 44.450	C210
05185	<i>D</i> 47.000	C210
07079	<i>d</i> 20.000	C210
07087	<i>d</i> 22.225	C210
07097	<i>d</i> 25.000	C212
07098	<i>d</i> 24.981	C212
07100	<i>d</i> 25.400	C212
07100SA	<i>d</i> 25.400	C212
07196	<i>D</i> 50.005	C210,C212
07204	<i>D</i> 51.994	C210,C212
07205	<i>D</i> 52.001	C212
08118	<i>d</i> 30.162	C214
08125	<i>d</i> 31.750	C214
08231	<i>D</i> 58.738	C214
09062	<i>d</i> 15.875	C210
09067	<i>d</i> 19.050	C210
09074	<i>d</i> 19.050	C210
09078	<i>d</i> 19.050	C210
09081	<i>d</i> 20.625	C210
09194	<i>D</i> 49.225	C210
09195	<i>D</i> 49.225	C210
09196	<i>D</i> 49.225	C210
11162	<i>d</i> 41.275	C220
11300	<i>D</i> 76.200	C220
11520	<i>D</i> 42.862	C210
11590	<i>d</i> 15.875	C210
LM11710	<i>D</i> 39.878	C210
LM11749	<i>d</i> 17.462	C210
LM11910	<i>D</i> 45.237	C210
LM11949	<i>d</i> 19.050	C210
12168	<i>d</i> 42.862	C220
12303	<i>D</i> 76.992	C220
12520	<i>D</i> 49.225	C210
12580	<i>d</i> 20.638	C210
M12610	<i>D</i> 50.005	C210
M12648	<i>d</i> 22.225	C210
M12649	<i>d</i> 21.430	C210
LM12710	<i>D</i> 45.237	C210
LM12711	<i>D</i> 45.975	C210
LM12749	<i>d</i> 22.000	C210
13175	<i>d</i> 44.450	C220
13181	<i>d</i> 46.038	C222
13318	<i>D</i> 80.962	C220,C222
13620	<i>D</i> 69.012	C218
13621	<i>D</i> 69.012	C218

Designation INNER RING, OUTER RING	Nominal Dimension (mm) <i>d</i> : I. R. (Bore Dia.) <i>D</i> : O. R. (Outside Dia.)	Pages
13685	<i>d</i> 38.100	C218
13687	<i>d</i> 38.100	C218
13830	<i>D</i> 63.500	C218
13889	<i>d</i> 38.100	C218
14123 A	<i>d</i> 31.750	C214
14125 A	<i>d</i> 31.750	C214
14130	<i>d</i> 33.338	C216
14131	<i>d</i> 33.338	C216
14137 A	<i>d</i> 34.925	C216
14138 A	<i>d</i> 34.925	C216
14139	<i>d</i> 34.976	C216
14274	<i>D</i> 69.012	C214,C216
14276	<i>D</i> 69.012	C214,C216
14283	<i>D</i> 72.085	C216
15100	<i>d</i> 25.400	C212
15101	<i>d</i> 25.400	C212
15106	<i>d</i> 26.988	C212
15112	<i>d</i> 28.575	C212
15113	<i>d</i> 28.575	C212
15116	<i>d</i> 30.112	C214
15117	<i>d</i> 30.000	C214
15118	<i>d</i> 30.213	C214
15119	<i>d</i> 30.213	C214
15120	<i>d</i> 30.213	C214
15123	<i>d</i> 31.750	C214
15125	<i>d</i> 31.750	C214
15126	<i>d</i> 31.750	C214
15245	<i>D</i> 62.000	C212,C214
15250	<i>D</i> 63.500	C214
15250 X	<i>D</i> 63.500	C212
15520	<i>D</i> 57.150	C212
15523	<i>D</i> 60.325	C212
15578	<i>d</i> 25.400	C212
15580	<i>d</i> 26.988	C212
16150	<i>d</i> 38.100	C218
16284	<i>D</i> 72.238	C218
16929	<i>D</i> 74.988	C220
16986	<i>d</i> 43.000	C220
17098	<i>d</i> 24.981	C212
17118	<i>d</i> 30.000	C214
17244	<i>D</i> 62.000	C212,C214
17520	<i>D</i> 42.862	C210
17580	<i>d</i> 15.875	C210
17831	<i>D</i> 79.985	C222
17887	<i>d</i> 45.230	C222
18200	<i>d</i> 50.800	C224
18337	<i>D</i> 85.725	C224
18520	<i>D</i> 73.025	C218
18590	<i>d</i> 41.275	C218
18620	<i>D</i> 79.375	C222
18690	<i>d</i> 46.038	C222
18720	<i>D</i> 85.000	C224
18790	<i>d</i> 50.800	C224
19138	<i>d</i> 34.976	C216

Designation INNER RING, OUTER RING	Nominal Dimension (mm) <i>d</i> : I. R. (Bore Dia.) <i>D</i> : O. R. (Outside Dia.)	Pages
19150	<i>d</i> 38.100	C218
19268	<i>D</i> 68.262	C216,C218
21075	<i>d</i> 19.050	C210
21212	<i>D</i> 53.975	C210
L21511	<i>D</i> 34.988	C210
L21549	<i>d</i> 15.875	C210
22168	<i>d</i> 42.862	C220
22325	<i>D</i> 82.550	C220
23100	<i>d</i> 25.400	C212
23256	<i>D</i> 65.088	C212
23621	<i>D</i> 73.025	C216
23691	<i>d</i> 35.000	C216
24720	<i>D</i> 76.200	C220
24721	<i>D</i> 76.200	C220
24780	<i>d</i> 41.275	C220
25520	<i>D</i> 82.931	C220,C222
25521	<i>D</i> 82.931	C220
25523	<i>D</i> 82.931	C220,C222
25577	<i>d</i> 42.875	C220
25578	<i>d</i> 42.862	C220
25580	<i>d</i> 44.450	C220
25584	<i>d</i> 44.983	C222
25590	<i>d</i> 45.618	C222
25820	<i>D</i> 73.025	C216
25821	<i>D</i> 73.025	C216,C218
25877	<i>d</i> 34.925	C216
25878	<i>d</i> 34.925	C216
25880	<i>d</i> 36.487	C218
26118	<i>d</i> 30.000	C214
26131	<i>d</i> 33.338	C216
26283	<i>D</i> 72.000	C214,C216
26820	<i>D</i> 80.167	C220
26822	<i>D</i> 79.375	C220
26823	<i>D</i> 76.200	C220
26882	<i>d</i> 41.275	C220
26884	<i>d</i> 42.875	C220
27620	<i>D</i> 125.412	C234
27687	<i>d</i> 82.550	C234
27689	<i>d</i> 83.345	C234
27690	<i>d</i> 83.345	C234
27820	<i>D</i> 80.035	C218
27880	<i>d</i> 38.100	C218
28138	<i>d</i> 34.976	C216
28315	<i>D</i> 80.000	C216
28521	<i>D</i> 92.075	C224
28580	<i>d</i> 50.800	C224
28584	<i>d</i> 52.388	C224
28622	<i>D</i> 97.630	C226
28680	<i>d</i> 55.562	C226
28920	<i>D</i> 101.600	C228
28921	<i>D</i> 100.000	C228
28985	<i>d</i> 60.325	C228
29520	<i>D</i> 107.950	C228
29586	<i>d</i> 63.500	C228

Designation INNER RING, OUTER RING	Nominal Dimension (mm) d: I. R. (Bore Dia.) D: O. R. (Outside Dia.)	Pages
29620	D 112.712	C230, C232
29630	D 120.650	C230
29675	d 69.850	C230
29685	d 73.025	C232
LM29710	D 65.088	C218
LM29711	D 65.088	C218
LM29748	d 38.100	C218
LM29749	d 38.100	C218
31520	D 76.200	C216
31594	d 34.925	C216
33262	d 66.675	C230
33275	d 69.850	C230
33281	d 71.438	C232
33287	d 73.025	C232
JHM33410	D 55.000	C212
JHM33449	d 24.000	C212
33462	D 117.475	C230, C232
33821	D 95.250	C224
33889	d 50.800	C224
34300	d 76.200	C232
34306	d 77.788	C234
34478	D 121.442	C232, C234
36620	D 193.675	C242
36690	d 146.050	C242
36920	D 227.012	C244
36990	d 177.800	C244
37425	d 107.950	C240
37625	D 158.750	C240
M38510	D 66.675	C216
M38511	D 65.987	C216
M38547	d 35.000	C216
M38549	d 34.925	C216
39236	d 60.000	C228
39250	d 63.500	C228
39412	D 104.775	C228
39520	D 112.712	C228, C230
39521	D 112.712	C230
39585	d 63.500	C228
39590	d 66.675	C230
41100	d 25.400	C212
41125	d 28.575	C212
41126	d 28.575	C212
41286	D 72.626	C212
42350	d 88.900	C236
42362	d 92.075	C238
42368	d 93.662	C238
42375	d 95.250	C238
42376	d 95.250	C238
42381	d 96.838	C238
42584	D 148.430	C238
42587	D 149.225	C236, C238
42620	D 127.000	C232, C234
42687	d 76.200	C232
42688	d 76.200	C232

Designation INNER RING, OUTER RING	Nominal Dimension (mm) d: I. R. (Bore Dia.) D: O. R. (Outside Dia.)	Pages
42690	d 77.788	C234
43118	d 30.162	C214
43131	d 33.338	C216
43300	D 76.200	C214
43312	D 79.375	C216
44143	d 36.512	C218
44150	d 38.100	C218
44157	d 40.000	C218
44162	d 41.275	C220
44348	D 88.501	C218, C220
L44610	D 50.292	C212
L44640	d 23.812	C212
L44643	d 25.400	C212
L44649	d 26.988	C212
45220	D 104.775	C226
45221	D 104.775	C226
45289	d 57.150	C226
L45410	D 50.292	C214
L45449	d 29.000	C214
46143	d 36.512	C218
46162	d 41.275	C220
46176	d 44.450	C220
46368	D 93.662	C218, C220
46720	D 225.425	C242
46780	d 158.750	C242
47420	D 120.000	C230, C232
47487	d 69.850	C230
47490	d 71.438	C232
47620	D 133.350	C232, C234
47680	d 76.200	C232
47685	d 82.550	C234
47686	d 82.550	C234
47687	d 82.550	C234
47820	D 146.050	C238
47890	d 92.075	C238
47896	d 95.250	C238
48120	D 161.925	C240
48190	d 107.950	C240
48220	D 182.562	C242
48282	d 120.650	C242
48286	d 123.825	C242
48290	d 127.000	C242
48320	D 190.500	C242
48385	d 133.350	C242
48393	d 136.525	C242
LM48510	D 65.088	C216
LM48511	D 65.088	C216
LM48548	d 34.925	C216
48620	D 200.025	C242
48685	d 142.875	C242
49175	d 44.450	C220
49176	d 44.450	C220
49368	D 93.662	C220
49520	D 101.600	C224

Designation INNER RING, OUTER RING	Nominal Dimension (mm) d: I. R. (Bore Dia.) D: O. R. (Outside Dia.)	Pages
49585	d 50.800	C224
52387	d 98.425	C238
52393	d 100.012	C238
52400	d 101.600	C240
52618	D 157.162	C238, C240
52637	D 161.925	C238, C240
53150	d 38.100	C218
53162	d 41.275	C220
53176	d 44.450	C222
53177	d 44.450	C222
53178	d 44.450	C222
53375	D 95.250	C218, C222
53387	D 98.425	C220, C222
55175	d 44.450	C222
55187	d 47.625	C222
55200	d 50.800	C224
55200 C	d 50.800	C224
55206	d 52.388	C224
55437	D 111.125	C222, C224
55443	D 112.712	C222
56418	d 106.362	C240
56425	d 107.950	C240
56650	D 165.100	C240
59200	d 50.800	C224
59429	D 108.966	C224
64433	d 109.992	C240
64450	d 114.300	C240
64700	D 177.800	C240
65200	d 50.800	C224
65212	d 53.975	C226
65237	d 60.325	C228
65320	D 114.300	C222
65385	d 44.450	C222
65500	D 127.000	C224, C226, C228
66187	D 47.625	C222
66462	D 117.475	C222
66520	D 122.238	C226, C228
66584	d 53.975	C226
66585	d 60.000	C228
66587	d 57.150	C226
LM67010	D 59.131	C212, C214
LM67043	d 28.575	C212
LM67048	d 31.750	C214
67320	D 203.200	C242
67322	D 196.850	C242
67388	d 127.000	C242
67389	d 130.175	C242
67390	d 133.350	C242
67720	D 247.650	C242, C244
67780	d 165.100	C242
67787	d 174.625	C244
67790	d 177.800	C244
67820	D 266.700	C244
67885	d 190.500	C244

Designation INNER RING, OUTER RING	Nominal Dimension (mm) d: I. R. (Bore Dia.) D: O. R. (Outside Dia.)	Pages
67920	D 282.575	C244
67983	D 203.200	C244
67985	d 206.375	C244
L68110	D 59.131	C216
L68111	D 59.975	C216
L68149	d 35.000	C216
68450	d 114.300	C240
68462	d 117.475	C240
68709	D 180.000	C240
68712	D 180.975	C240
JL69310	D 63.000	C218
JL69349	d 38.000	C218
71412	d 104.775	C240
71425	d 107.950	C240
71437	d 111.125	C240
71450	d 114.300	C240
71453	d 115.087	C240
71750	D 190.500	C240
72187	d 47.625	C222
72200	d 50.800	C224
72200 C	d 50.800	C224
72212	d 53.975	C226
72212 C	d 53.975	C226
72218	d 55.562	C226
72218 C	d 55.562	C226
72225 C	d 57.150	C226
72487	D 123.825	C222, C224, C226
LM72810	D 47.000	C212
LM72849	d 22.606	C212
74500	d 127.000	C242
74525	d 133.350	C242
74537	d 136.525	C242
74550	d 139.700	C242
74850	D 215.900	C242
74856	D 217.488	C242
77375	d 95.250	C238
77675	D 171.450	C238
78225	d 57.150	C226
78250	d 63.500	C228
LM78310	D 62.000	C216
LM78310 A	D 62.000	C216
LM78349	d 35.000	C216
78537	D 136.525	C228
78551	D 140.030	C226, C228
78571	D 144.983	C226
HM81610	D 47.000	C210
HM81649	d 16.000	C210
M84210	D 59.530	C212
M84249	d 25.400	C212
M84510	D 57.150	C212
M84548	d 25.400	C212
M86610	D 64.292	C212, C214
M86643	d 25.400	C212
M86647	d 28.575	C212

Designation INNER RING, OUTER RING	Nominal Dimension (mm) d: I. R. (Bore Dia.) D: O. R. (Outside Dia.)	Pages
M86648A M86649 M88010	<i>d</i> 30.955 <i>d</i> 30.162 <i>D</i> 68.262	C214 C214 C214, C216
M88043 M88046 M88048	<i>d</i> 30.162 <i>d</i> 31.750 <i>d</i> 33.338	C214 C214 C216
HM88510 HM88542 HM88547	<i>D</i> 73.025 <i>d</i> 31.750 <i>d</i> 33.338	C214, C216 C214 C216
HM88610 HM88630 HM88638	<i>D</i> 72.233 <i>d</i> 25.400 <i>d</i> 32.000	C212, C214, C216, C218 C212 C214
HM88648 HM88649 HM89410	<i>d</i> 35.717 <i>d</i> 34.925 <i>D</i> 76.200	C218 C216 C216, C218
HM89411 HM89443 HM89444	<i>D</i> 76.200 <i>d</i> 33.338 <i>d</i> 33.338	C216 C216 C216
HM89446 HM89446A HM89449	<i>d</i> 34.925 <i>d</i> 34.925 <i>d</i> 36.512	C216 C216 C218
99100 99550 99575	<i>D</i> 254.000 <i>d</i> 139.700 <i>d</i> 146.050	C242 C242 C242
99587 99600 LM102910	<i>d</i> 149.225 <i>d</i> 152.400 <i>D</i> 73.431	C242 C242 C222
LM102949 JLM104910 LM104911	<i>d</i> 45.242 <i>D</i> 82.000 <i>D</i> 82.550	C222 C224 C224
LM104911A LM104912 LM104947A	<i>D</i> 82.550 <i>D</i> 82.931 <i>d</i> 50.000	C224 C224 C224
JLM104948 LM104949 M201011	<i>d</i> 50.000 <i>d</i> 50.800 <i>D</i> 73.025	C224 C224 C218
M201047 JM205110 JM205149	<i>d</i> 39.688 <i>D</i> 90.000 <i>d</i> 50.000	C218 C224 C224
JM207010 JM207049 JH211710	<i>D</i> 95.000 <i>d</i> 55.000 <i>D</i> 120.000	C226 C226 C230
JH211749 HM212010 HM212011	<i>d</i> 65.000 <i>D</i> 122.238 <i>D</i> 122.238	C230 C228, C230 C228, C230
HM212044 HM212046 HM212047	<i>d</i> 60.325 <i>d</i> 63.500 <i>d</i> 63.500	C228 C228 C228
HM212049 JH217210 JH217249	<i>d</i> 66.675 <i>D</i> 150.000 <i>d</i> 85.000	C230 C236 C236
HM218210 HM218248 HH221410	<i>D</i> 147.000 <i>d</i> 90.000 <i>D</i> 190.500	C236 C236 C236, C238, C240

Designation INNER RING, OUTER RING	Nominal Dimension (mm) d: I. R. (Bore Dia.) D: O. R. (Outside Dia.)	Pages
HH221432 HH221434 HH221440	<i>d</i> 87.312 <i>d</i> 88.900 <i>d</i> 95.250	C236 C236 C238
HH221442 HH221447 HH221449	<i>d</i> 98.425 <i>d</i> 99.982 <i>d</i> 101.600	C238 C238 C240
HH224310 HH224335 HH224340	<i>D</i> 212.725 <i>d</i> 101.600 <i>d</i> 107.950	C240 C240 C240
HH224346 M224710 M224748	<i>d</i> 114.300 <i>D</i> 174.625 <i>d</i> 120.000	C240 C242 C242
LL225710 LL225749 HM231110	<i>D</i> 165.895 <i>d</i> 127.000 <i>D</i> 236.538	C242 C242 C242
HM231140 M236810 M236849	<i>d</i> 146.050 <i>D</i> 260.350 <i>d</i> 177.800	C242 C244 C244
LM300811 LM300849 L305610	<i>D</i> 68.000 <i>d</i> 41.000 <i>D</i> 80.962	C218 C218 C224
L305649 JH307710 JH307749	<i>d</i> 50.800 <i>D</i> 110.000 <i>d</i> 55.000	C224 C226 C226
JHM318410 JHM318448 L327210	<i>D</i> 155.000 <i>d</i> 90.000 <i>D</i> 177.008	C236 C236 C242
L327249 LM328410 LM328448	<i>d</i> 133.350 <i>D</i> 187.325 <i>d</i> 139.700	C242 C242 C242
H414210 H414245 H414249	<i>D</i> 136.525 <i>d</i> 68.262 <i>d</i> 71.438	C230, C232 C230 C232
JH415610 JH415647 LM501310	<i>D</i> 145.000 <i>d</i> 75.000 <i>D</i> 73.431	C232 C232 C218
LM501314 LM501349 LM503310	<i>D</i> 73.431 <i>d</i> 41.275 <i>D</i> 75.000	C218 C218 C222
LM503349 HH506310 HH506348	<i>d</i> 46.000 <i>D</i> 114.300 <i>d</i> 49.212	C222 C224 C224
JLM506810 JLM506849 JLM508710	<i>D</i> 90.000 <i>d</i> 55.000 <i>D</i> 95.000	C226 C226 C228
JLM508748 JM511910 JM511946	<i>d</i> 60.000 <i>D</i> 110.000 <i>d</i> 65.000	C228 C230 C230
JM515610 JM515649 HM516410	<i>D</i> 130.000 <i>d</i> 80.000 <i>D</i> 133.350	C234 C234 C234
HM516448 JHM516810 JHM516849	<i>d</i> 82.550 <i>D</i> 140.000 <i>d</i> 85.000	C234 C236 C236

Designation INNER RING, OUTER RING	Nominal Dimension (mm) d: I. R. (Bore Dia.) D: O. R. (Outside Dia.)	Pages
HM518410 HM518445 LM522510	<i>D</i> 152.400 <i>d</i> 88.900 <i>D</i> 159.987	C236 C236 C240
LM522546 LM522548 LM522549	<i>d</i> 107.950 <i>d</i> 109.987 <i>d</i> 109.987	C240 C240 C240
JHM522610 JHM522649 JHM534110	<i>D</i> 180.000 <i>d</i> 110.000 <i>D</i> 230.000	C240 C240 C244
JHM534149 LM603011 LM603012	<i>d</i> 170.000 <i>D</i> 77.788 <i>D</i> 77.788	C244 C222 C222
LM603049 L610510 L610549	<i>d</i> 45.242 <i>D</i> 94.458 <i>d</i> 63.500	C222 C228 C228
JM612910 JM612949 LM613410	<i>D</i> 115.000 <i>d</i> 70.000 <i>D</i> 112.712	C232 C232 C230
LM613449 HM617010 HM617049	<i>d</i> 69.850 <i>D</i> 142.138 <i>d</i> 85.725	C230 C236 C236
L623110 L623149 JLM710910	<i>D</i> 152.400 <i>d</i> 114.300 <i>D</i> 105.000	C240 C240 C230
JLM710949 JLM714110 JLM714149	<i>d</i> 65.000 <i>D</i> 115.000 <i>d</i> 75.000	C230 C232 C232
JM714210 JM714249 H715311	<i>D</i> 120.000 <i>d</i> 75.000 <i>D</i> 136.525	C232 C232 C228, C230, C232
H715334 H715340 H715341	<i>d</i> 61.912 <i>d</i> 65.088 <i>d</i> 66.675	C228 C230 C230
H715343 H715345 JM716610	<i>d</i> 68.262 <i>d</i> 71.438 <i>D</i> 130.000	C230 C232 C236
JM716648 JM716649 JM718110	<i>d</i> 85.000 <i>d</i> 85.000 <i>D</i> 145.000	C236 C236 C236
JM718149 JM719113 JM719149	<i>d</i> 90.000 <i>D</i> 150.000 <i>d</i> 95.000	C236 C238 C238
JM720210 JHM720210 JM720249	<i>D</i> 155.000 <i>D</i> 160.000 <i>d</i> 100.000	C238 C238 C238
JHM720249 JL724314 JL724348	<i>d</i> 100.000 <i>D</i> 170.000 <i>d</i> 120.000	C238 C242 C242
JL725316 JL725346 JM734410	<i>d</i> 175.000 <i>d</i> 125.000 <i>D</i> 240.000	C242 C242 C244
JM734449 JM738210 JM738249	<i>d</i> 170.000 <i>D</i> 260.000 <i>d</i> 190.000	C244 C244 C244

Designation INNER RING, OUTER RING	Nominal Dimension (mm) d: I. R. (Bore Dia.) D: O. R. (Outside Dia.)	Pages
HM801310 HM801346 M802011	<i>D</i> 82.550 <i>d</i> 38.100 <i>D</i> 82.550	C218 C218 C220
M802048 HM803110 HM803145	<i>d</i> 41.275 <i>D</i> 88.900 <i>d</i> 41.275	C220 C220 C220
HM803146 HM803149 M804010	<i>d</i> 41.275 <i>D</i> 44.450 <i>d</i> 88.900	C220 C220 C222
M804049 HM804810 HM804840	<i>d</i> 47.625 <i>D</i> 95.250 <i>d</i> 41.275	C222 C220, C222, C224 C220
HM804843 HM804846 HM804848	<i>d</i> 44.450 <i>d</i> 47.625 <i>d</i> 48.412	C222 C222 C224
HM804849 HM807010 HM807011	<i>d</i> 48.412 <i>D</i> 104.775 <i>D</i> 104.775	C224 C222, C224 C224
JHM807012 HM807040 HM807044	<i>D</i> 105.000 <i>d</i> 44.450 <i>d</i> 49.212	C224 C222 C224
JHM807045 HM807046 JLM813010	<i>d</i> 50.000 <i>d</i> 50.800 <i>D</i> 110.000	C224 C224 C232
JLM813049 JLM820012 JLM820048	<i>d</i> 70.000 <i>D</i> 150.000 <i>d</i> 100.000	C232 C238 C238
JM822010 JM822049 JHM840410	<i>D</i> 165.000 <i>d</i> 110.000 <i>D</i> 300.000	C240 C240 C244
JHM840449 HM903210 HM903247	<i>d</i> 200.000 <i>D</i> 95.250 <i>d</i> 44.450	C244 C222 C222
HM903249 HM911210 HM911242	<i>d</i> 44.450 <i>D</i> 130.175 <i>d</i> 53.975	C222 C226 C226
H913810 H913842 H913849	<i>D</i> 146.050 <i>d</i> 61.912 <i>d</i> 69.850	C228, C230 C228 C230

Worldwide Sales Offices

P: Phone F: Fax ☆: Head Office

NSK LTD.-HEADQUARTERS, TOKYO, JAPAN

Nissei Bldg., 1-6-3 Ohaski, Shinagawa-ku, Tokyo 141-8560, Japan

INDUSTRIAL MACHINERY BUSINESS DIVISION-HEADQUARTERS

P: +81-3-3779-7227 F: +81-3-3779-7432

AUTOMOTIVE BUSINESS DIVISION-HEADQUARTERS

P: +81-3-3779-7189 F: +81-3-3779-7917

●Africa

South Africa:

NSK SOUTH AFRICA (PTY) LTD.

SANDTON 25 Galaxy Avenue, Linbro Business Park, Sandton 2146, South Africa
P: +27-011-458-3600 F: +27-011-458-3608

●Asia and Oceania

Australia:

NSK AUSTRALIA PTY. LTD.

MELBOURNE ☆ 100 Logis Boulevard, Dandenong South, Victoria, 3175, Australia
P: +61-3-9765-4400 F: +61-3-9765-4466

SYDNEY Suite A315, 20 Lexington Drive, Bella Vista, New South Wales, 2153, Australia
P: +61-2-9839-2300 F: +61-2-8824-5794

BRISBANE 1/69 Selhurst Street, Coopers Plains, Queensland 4108, Australia
P: +61-7-3347-2600 F: +61-7-3345-5376

PERTH Unit 1, 71 Tacoma Circuit, Canning Vale, Western Australia 6155, Australia
P: +61-8-9256-5000 F: +61-8-9256-1044

New Zealand:

NSK NEW ZEALAND LTD.

AUCKLAND Unit F, 70 Business Parade South, Highbrook, Business Park Auckland 2013, New Zealand
P: +64-9-276-4992 F: +64-9-276-4082

China:

NSK (SHANGHAI) TRADING CO., LTD.

JIANGSU No.8 NSK Rd., Huaqiao Economic Development Zone, Kunshan, Jiangsu, China (215332)
P: +86-512-5796-3000 F: +86-512-5796-3300

NSK (CHINA) INVESTMENT CO., LTD.

JIANGSU ☆ No.8 NSK Rd., Huaqiao Economic Development Zone, Kunshan, Jiangsu, China (215332)
P: +86-512-5796-3000 F: +86-512-5796-3300

BEIJING Room 1906, Beijing Fortune Bldg., No.5 Dong San Huan Bei Lu, Chao Yang District, Beijing, China (100004)
P: +86-10-6590-8161 F: +86-10-6590-8166

TIAN JIN Unit 4604, 46/F., Metropolitan Tower, 183 Nanjing Road, Heping District, Tianjin, China (300051)
P: +86-22-8319-5030 F: +86-22-8319-5033

CHANGCHUN Room 902-03, Changchun Hongwell International Plaza, No.3299 Renmin Street, Changchun, Jilin, China (130061)
P: +86-431-8898-8682 F: +86-431-8898-8670

SHENYANG Room 1101, China Resources Building, No. 286 Qingnian Street, Heping District, Shenyang Liaoning, China (110004)
P: +86-24-2334-2868 F: +86-24-2334-2058

DALIAN Room 1805 Xivang Tower, No.136 Zhongshan Road, Zhongshan District, Dalian, Liaoning, China (116001)
P: +86-411-8800-8168 F: +86-411-8800-8160

NANJING Room A1 22F, Golden Eagle International Plaza, No.89 Hanzhong Road, Nanjing, Jiangsu, China (210029)
P: +86-25-8472-6671 F: +86-25-8472-6687

FUZHOU Room 1801-1811, B1#1A Class Office Building, Wanda Plaza, No.8 Aojiang Road, Fuzhou, China (350009)
P: +86-591-8380-1030 F: +86-591-8380-1225

WUHAN Room 1512, No.198Yuncui Road, Office Building, Oceanview City Square, JiangHan, District, WuHan, China (400039)
P: +86-27-8556-9630 F: +86-27-8556-9615

QINGDAO Room 802, Farglory International Plaza, No.26 Xianggang Zhong Road, Shinan District, Qingdao, Shandong, China (266071)
P: +86-532-5568-3877 F: +86-532-5568-3876

GUANGZHOU Room 1011-16, Yuexiu Financial Tower, No.28 Zhuijiang Road East, Zhuijiang New Town, Guangzhou, Guangdong, China (510627)
P: +86-20-3817-7800 F: +86-20-3786-4501

CHANGSHA Room 9209, Huayuan International Center, No.36, Section 2, Xiangjiang Middle Road, Tianxin District, Changsha, Hunan, China (410002)
P: +86-731-8571-3100 F: +86-731-8571-3255

LUOYANG Room 955, HUA-YANG PLAZA HOTEL, No.88 Kaixuan W.Rd., Jian Xi District, Luoyang, Henan Province, China (471003)
P: +86-379-6069-6188 F: +86-379-6069-6180

XI'AN Room 1007, B Changan Metropolis Center, No.88 Nanguanzheng Steet, Xi'an, Shanxi, China (710068)
P: +86-29-8765-1896 F: +86-29-8765-1895

CHONGQING Room 612, Commercial Apartment, Athestel Hotel, No.288, Keyuan Rd.4, Jiulongpo District, Chongqing, China (400039)
P: +86-23-6806-5310 F: +86-23-6806-5292

CHENGDU Room 1117, Lippo Tower, No.62 North Kahua Road, Chengdu, Sichuan, China (610041)
P: +86-28-8528-3680 F: +86-28-8528-3690

NSK CHINA SALES CO., LTD.

JIANGSU No.8 NSK Rd., Huaqiao Economic Development Zone, Kunshan, Jiangsu, China (215332)
P: +86-512-5796-3000 F: +86-512-5796-3300

NSK HONG KONG LTD.

HONG KONG ☆ Suite 705, 7th Floor, South Tower, World Finance Centre, Harbour City, T.S.T., Kowloon, Hong Kong, China
P: +852-2739-9933 F: +852-2739-9323

SHENZHEN Room 624-626, 6/F, Kerry Center, Renminnan Road, Shenzhen, Guangdong, China
P: +86-755-25904886 F: +86-755-25904883

Taiwan:

TAIWAN NSK PRECISION CO., LTD.

TAIPEI ☆ 10F-A6, No.168, Sec.3, Nanjing East Rd., Zhongshan Dist., Taipei City 104, Taiwan
P: +886-2-2772-3355 F: +886-2-2772-3300

TAICHUNG 3F.-2, No. 540, Sec. 3, Taiwan Blvd., Xitun Dist., Taichung City 407, Taiwan
P: +886-4-2708-3393 F: +886-4-2708-3395

TAINAN Rm. A1, 9F., No.189, Sec. 1, Yongfu Rd., West Central Dist., Tainan City 700, Taiwan
P: +886-6-215-6058 F: +886-6-215-5518

India:

NSK BEARINGS INDIA PRIVATE LTD.

CHENNAI ☆ TVH Belicia Towers, 2nd Floor, Block I, No.71/1, MRC Nagar Main Road, MRC Nagar, Chennai-600 028, India
P: +91-44-2847-9600 F: +91-44-2847-9601

MUMBAI No.321, A Wing, Ahura Centre, 82, Mahakali Caves Road, Andheri (E), Mumbai-400 093, India
P: +91-22-2838-7787

JAMSHEDPUR 13/A, 2nd Floor, Circuit House Area, North West Layout, Road No.12, (Near Sai Baba Mandir), Sonari, Jamshedpur-831 011, Jharkhand, India
P: +91-657-2421144

GURGAON Unit No. 202, 2nd Floor, 'A' Block, Iris Tech Park, Sector - 48 (Sohna Road), Gurgaon-122018, India
P: +91-124-4838000

Indonesia:

PT. NSK INDONESIA

JAKARTA Summitmas II, 6th Floor, Jl. Jend Sudirman Kav. 61-62, Jakarta 12190, Indonesia
P: +62-21-252-3458 F: +62-21-252-3223

Korea:

NSK KOREA CO., LTD.

SEOUL Posco Center (West Wing) 9F, 440, Teheran-ro, Gangnam-gu, Seoul, 06194, Korea
P: +82-2-3287-0300 F: +82-2-3287-0345

Malaysia:

NSK BEARINGS (MALAYSIA) SDN. BHD.

SHAH ALAM ☆ No. 2, Jalan Pemaju, U1/15, Seksyen U1, Hicom Glenmarie Industrial Park, 40150 Shah Alam, Selangor, Malaysia
P: +60-3-7803-8859 F: +60-3-7806-5982

PRAI No.24, Jalan kikik, Taman Inderawasih, 13600 Prai, Penang, Malaysia
P: +60-4-3902275 F: +60-4-3991830

JOHOR BAHRU 88 Jalan Ros Merah 2/17, Taman Johor Jaya, 81100 Johor Bahru, Johor, Malaysia
P: +60-7-3546290 F: +60-7-3546291

IPOH No.10&10A, Jalan Industri Paloh, Kawasan Perindustrian Ringan Paloh, 30200 Ipoh, Perak, Malaysia
P: +60-5-2555000 F: +60-5-2553373

Philippines:

NSK REPRESENTATIVE OFFICE

MANILA 8th Floor The Salcedo Towers 169 H.V. Dela Costa St., Salcedo Village Makati City, Philippines 1227
P: +63-2-893-9543 F: +63-2-893-9173

Singapore:

NSK INTERNATIONAL (SINGAPORE) PTE LTD.

SINGAPORE 238A, Thomson Road, #24-01/05, Novena Square Tower A, Singapore 307684
P: +65-6496-8000 F: +65-6250-5845

NSK SINGAPORE (PRIVATE) LTD.

SINGAPORE 238A, Thomson Road, #24-01/05, Novena Square Tower A, Singapore 307684
P: +65-6496-8000 F: +65-6250-5845

Thailand:

NSK BEARINGS (THAILAND) CO., LTD.

BANGKOK 26 Soi Onnuh 55/1 Pravet Subdistrict, Pravet District, Bangkok 10250, Thailand
P: +66-2320-2555 F: +66-2320-2826

Vietnam:

NSK VIETNAM CO., LTD.

HANOI Techno Center, Room 204-205, Thang Long Industrial Park, Dong Anh District, Hanoi, Vietnam
P: +84-24-3955-0159 F: +84-24-3955-0158

NSK REPRESENTATIVE OFFICE

HO CHI MINH CITY Suite 307, Metropolitan Building, 235 Dong Khoi Street, District 1, HCMC, Vietnam
P: +84-28-3822-7907 F: +84-28-3822-7910

Worldwide Sales Offices

P: Phone F: Fax ☆: Head Office

●Europe

United Kingdom:

NSK EUROPE LTD. (EUROPEAN HEADQUARTERS)

MAIDENHEAD Belmont Place, Belmont Road, Maidenhead, Berkshire SL6 6TB, U.K.
P: +44-1628-509-800 F: +44-1628-509-808

NSK UK LTD.

NEWARK Northern Road, Newark, Nottinghamshire NG24 2JF, U.K.
P: +44-1636-605-123 F: +44-1636-605-000

France:

NSK FRANCE S.A.S.

PARIS Quartier de l'Europe, 2 Rue Georges Guynemer, 78283 Guyancourt, France
P: +33-1-30-57-39-39 F: +33-1-30-57-00-01

Germany:

NSK DEUTSCHLAND GMBH

DUSSELDORF ☆ Harkortstrasse 15, D-40880 Ratingen, Germany
P: +49-2102-4810 F: +49-2102-4812-290

STUTTGART Liebknechtstrasse 33, D-70565 Stuttgart-Vaihingen, Germany
P: +49-711-79082-0 F: +49-711-79082-289

WOLFSBURG Tischlerstrasse 3, D-38440 Wolfsburg, Germany
P: +49-5361-27647-10 F: +49-5361-27647-70

Italy:

NSK ITALIA S.P.A.

MILANO Via Garibaldi 215, Garbagnate Milanese (Milano) 20024, Italy
P: +39-299-5191 F: +39-299-025778

Netherlands:

NSK EUROPEAN DISTRIBUTION CENTRE B.V.

TILBURG Brakman 54, 5047 SW Tilburg, Netherlands
P: +31-13-4647647 F: +31-13-4641082

Poland:

NSK REPRESENTATIVE OFFICE

WARSAW Ul. Migdalowa 4/73, 02-796, Warsaw, Poland
P: +48-22-645-1525 F: +48-22-645-1529

Russia:

NSK POLSKA SP. Z O.O.

SAINT-PETERSBURG Office 1703, Bldg 29, 18th Line of Vasilievsky Ostrov, Saint-Petersburg, Russia, 199178
P: +7-812-332-5071 F: +7-812-332-5072

Spain:

NSK SPAIN S.A.

BARCELONA C/Tarragona, 161 Cuerdo Bajo, 2a Planta, 08014, Barcelona, Spain
P: +34-93-289-2763 F: +34-93-433-5776

Turkey:

NSK RULMANLARI ORTA DOGU TIC. LTD. STI.

ISTANBUL Cevizli Mahallesi, D-100 Güney Yanyolu, Kurş Kule İş Merkezi No:2 Kat:4, P.K.: 34846, Cevizli-Kartal-Istanbul, Turkey
P: +90-216-5000-675 F: +90-216-5000-676

United Arab Emirates:

NSK BEARINGS GULF TRADING CO.

DUBAI JAFZA View 19, Floor 24 Office LB192402/3, PO Box 262163, Downtown Jebel Ali, Dubai, U.A.E
P: +971-(0)4-804-8200 F: +971-(0)4-884-7227

●North and South America

United States of America:

NSK AMERICAS, INC. (AMERICAN HEADQUARTERS)

ANN ARBOR 4200 Goss Road, Ann Arbor, Michigan 48105, U.S.A.
P: +1-734-913-7500 F: +1-734-913-7511

NSK CORPORATION

ANN ARBOR 4200 Goss Road, Ann Arbor, Michigan 48105, U.S.A.
P: +1-734-913-7500 F: +1-734-913-7511

NSK PRECISION AMERICA, INC.

FRANKLIN ☆ 3450 Bearing Drive, Franklin, Indiana 46131, U.S.A.
P: +1-317-738-5000 F: +1-317-738-5050

SAN JOSE 780 Montague Expressway, Suite 505, San Jose, California, 95131, U.S.A.
P: +1-408-944-9400 F: +1-408-944-9405

NSK LATIN AMERICA, INC.

MIAMI 11601 NW 107 Street, Suite 200, Miami Florida, 33178, U.S.A.
P: +1-305-477-0605 F: +1-305-477-0377

Canada:

NSK CANADA INC.

TORONTO ☆ 317 Rutherford Road South, Brampton, Ontario, L6W 3R5, Canada
P: +1-905-890-0740 F: +1-800-800-2788

MONTREAL 2150-32E Avenue Lachine, Quebec, Canada H8T 3H7
P: +1-514-633-1220 F: +1-800-800-2788

Argentina:

NSK ARGENTINA SRL

BUENOS AIRES Garcia del Rio 2477 Piso 7 Oficina "A" (1429) Buenos Aires-Argentina
P: +54-11-4704-5100 F: +54-11-4704-0033

<As of December 2019>

For the latest information, please refer to the NSK website.

www.nsk.com

NSK Ltd. has a basic policy not to export any products or technology designated as controlled items by export-related laws. When exporting the products in this brochure, the laws of the exporting country must be observed. Specifications are subject to change without notice and without any obligation on the part of the manufacturer. Every care has been taken to ensure the accuracy of the data contained in this brochure, but no liability can be accepted for any loss or damage suffered through errors or omissions. We will gratefully acknowledge any additions or corrections.

MOTION & CONTROL™
NSK



NSK used environmentally friendly paper and printing methods for this publication.